

**Colar tampa furo adesivo nos parafusos das molduras**  
 Attach adhesive hole plug to frame screws  
 Pegue la tampa del orificio adhesivo en los tornillos del marco

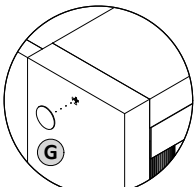

**Colar tampa furo adesivo nos parafusos externos**  
 Attach adhesive hole plug to external screws  
 Pegue la tampa del orificio adhesivo en los tornillos externos

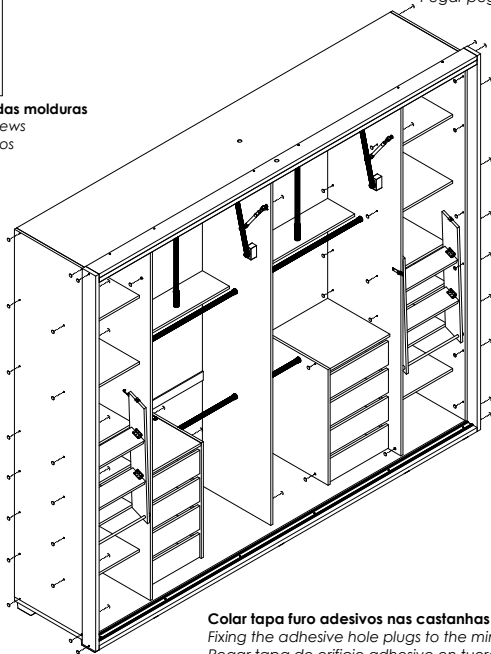
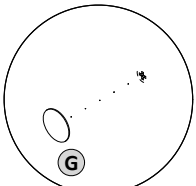

**Colar tampa furo adesivos nos parafusos internos**  
 Attach adhesive hole plugs to the internal screws  
 Pegar pegatinas en los agujeros tornillos internos

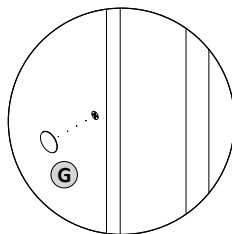

**Colar tampa furo adesivos nas castanhas minifix**  
 Fixing the adhesive hole plugs to the minifix nuts  
 Pegar tampa de orificio adhesivo en tuercas minifix

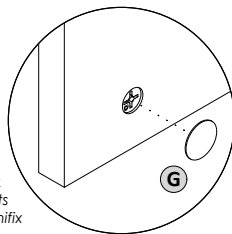

**PESO SUPORTADO | SUPPORTED WEIGHT | PESO SOPORTADO**

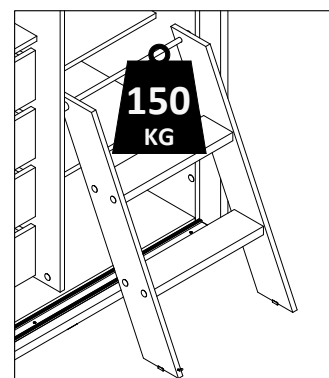
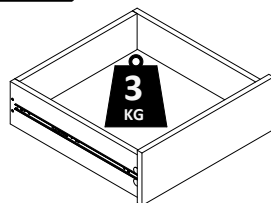
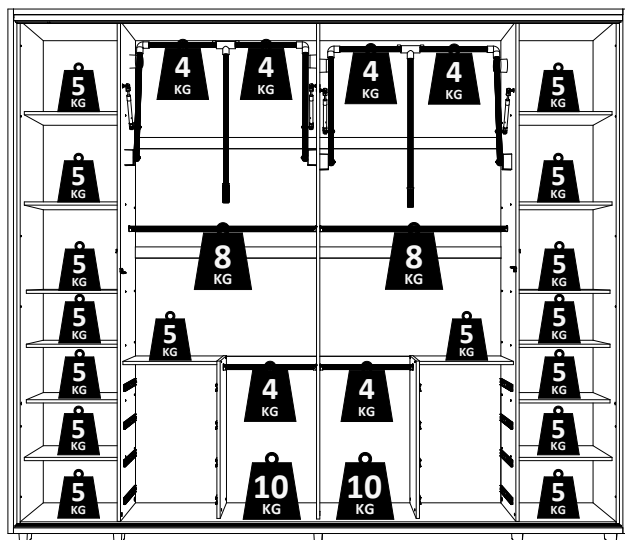

**CUIDADOS ESPECIAIS | SPECIAL CARES | CUIDADOS ESPECIALES:**

**LIMPEZA MADEIRA:** Pano limpo umedecido em água e sabão neutro - **BRILHO:** Flanela seca  
**CLEANING:** Clean cloth humidified in water and neutral soap - **SHINE:** Dry flannel  
**LIMPIEZA:** Tela limpia humedecida en la agua y el jabón neutro - **BRILLO:** Franela seca

Data última atualização  
 Last update  
 Fecha de última actualización  
**26.03.2025**

**161 - GUARDA-ROUPA DALÍ**  
 WARDROBE | ROPERO



**ESQUEMA DE MONTAGEM | ASSEMBLY INSTRUCTIONS | ESQUEMA DE MONTAJE**

**ASPECTO FINAL | FINAL ASPECT**



**ESPAZZO**

É tudo.  
 E um pouco mais.

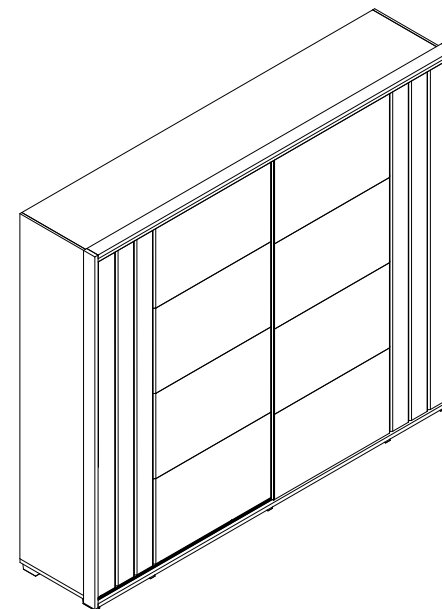

**Pessoas necessárias para montagem**  
 People required for assembly  
 Personas necesarias para el montaje



**Ferramentas necessárias para montagem (não fornecidas)**  
 Tools required for assembly (not provided)

Herramientas necesarias para el montaje. (no proporcionado)

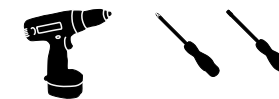

**Parafusadeira ou chave de fenda e philips**  
 Screwdriver or Phillips screwdriver  
 Destornillador o destornillador y Philips



**Martelo | Hammer | Martillo**



**Trena | Measuring tape | Cinta métrica**

**INSTRUÇÕES | INSTRUCTIONS | INSTRUCCIONES**

- Prepare a montagem do móvel próximo ao local que ele ficará definitivamente e evite deslocá-lo depois de montado;  
 - Forre o chão com papelão ou similar e utilize a isomanta que vem entre as peças para evitar o contato entre elas durante a montagem;  
 - Monte o móvel obedecendo a ordem numérica da **sequência de montagem (S.M.)**, identificando as peças pelo **código de peça (C.P.)** carimbado na mesma.

- Prepare the assembly of the close piece of furniture to the place that it will be definitively and avoid to move after done. Will be definitively and avoid to move after done;  
 - Cover the ground with cardboard or similar and use the isomanta that it comes among the pieces to avoid the contact among them during the assembly;  
 - Set up the piece of furniture obeying the numeric order of the **assembly sequence (S.M.)**, identifying the pieces by **code of piece (C.P.)** stamped in the same.

- Prepare la montaje del mobiliario proximo al lugar que estará definitivamente y evite mover después de hecho;  
 - Tape la tierra con el cartón o similar y use la "isomanta" que viene entre las piezas para evitar el contacto entre ellos durante la montaje;  
 - Monte el mobiliario obedeciendo la orden numérica de la **sucesión de montaje (S.M.)**, identificando las piezas por el **código de piezas (C.P.)** de la misma estampado en esta.



Atendimento ao consumidor | Attendance to the consumer | Asistencia al consumidor  
 tel +55 43 3303 1800  
 madetec@madetec.com.br

**Madetec Móveis Ltda.**  
 Rua Rouxinol 5205 | Parque Industrial IV  
 CEP 86706-418 | Araçongas | PR | Brasil  
 www.madetec.com.br

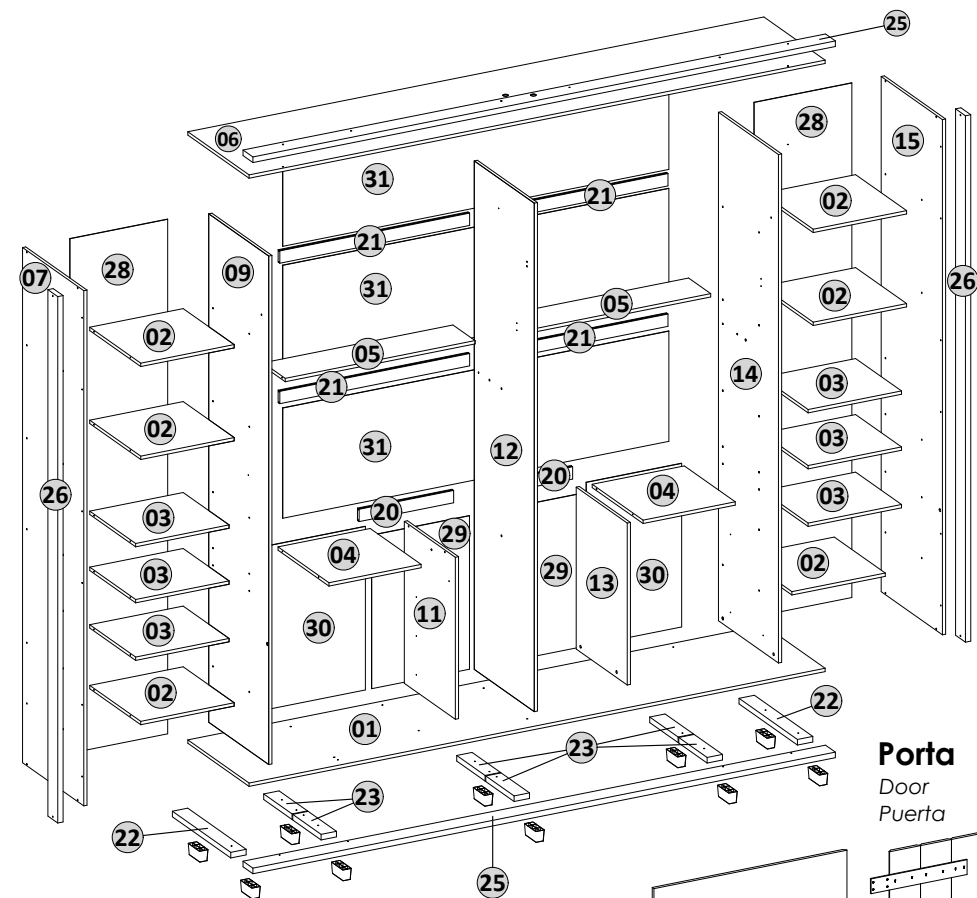

**Porta**  
Door  
Puerta

**Escada**  
Stairs  
Escalera

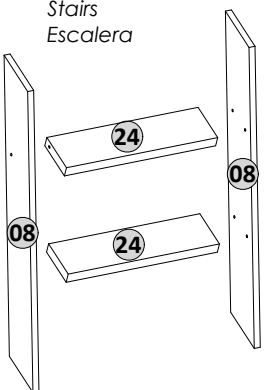

**Gaveta**  
Drawer  
Cajón

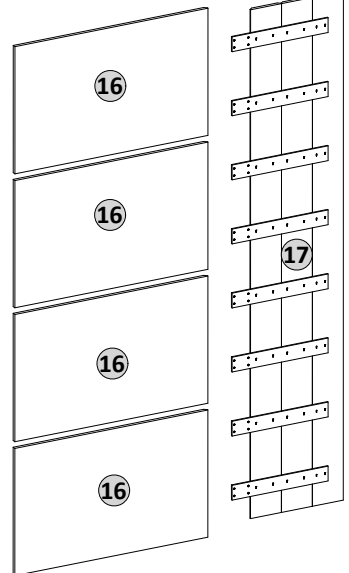
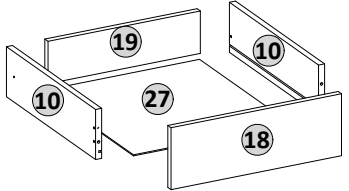



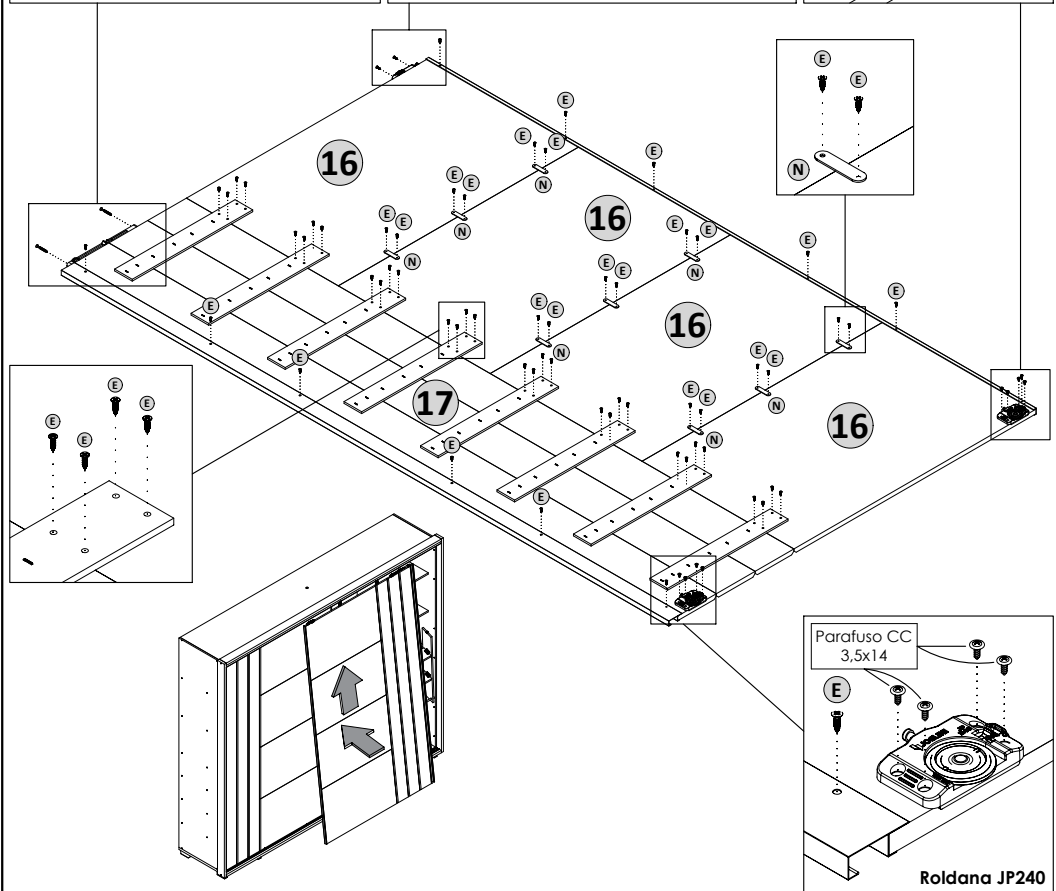
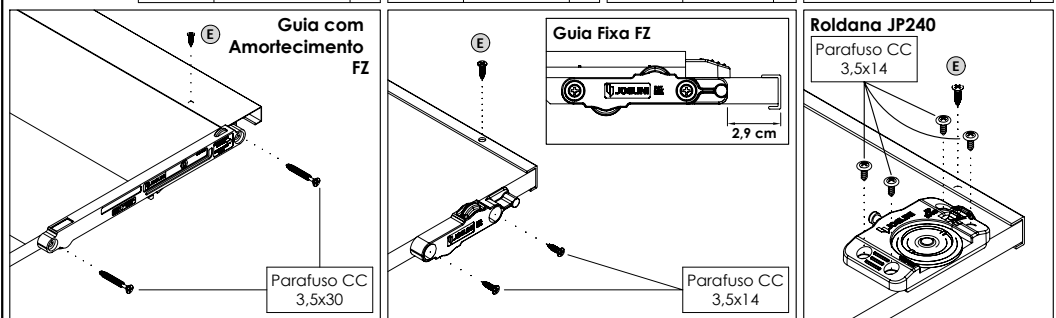

**22º PASSO | PASS | PASO**

PEÇAS PIECES PIEZAS	E	62	N	9	Roldana JP240	2	Guia com Amortecimento FZ	1
S.M.   C.P.	01   17							
	02   16							
	03   16							
	04   16							
	05   16							

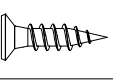
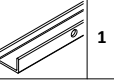

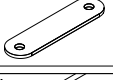
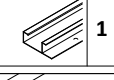
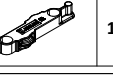
21º PASSO | PASS | PASO

PEÇAS PIECES PIEZAS	<b>E</b>		62	<b>X</b>		1	Guia com Amortecimento FZ		1
S.M.   C.P.	<b>N</b>		9	<b>W</b>		1	Guia Fixa FZ		1
01   17							Roldana JP240		2
02   16									
03   16									
04   16									
05   16									

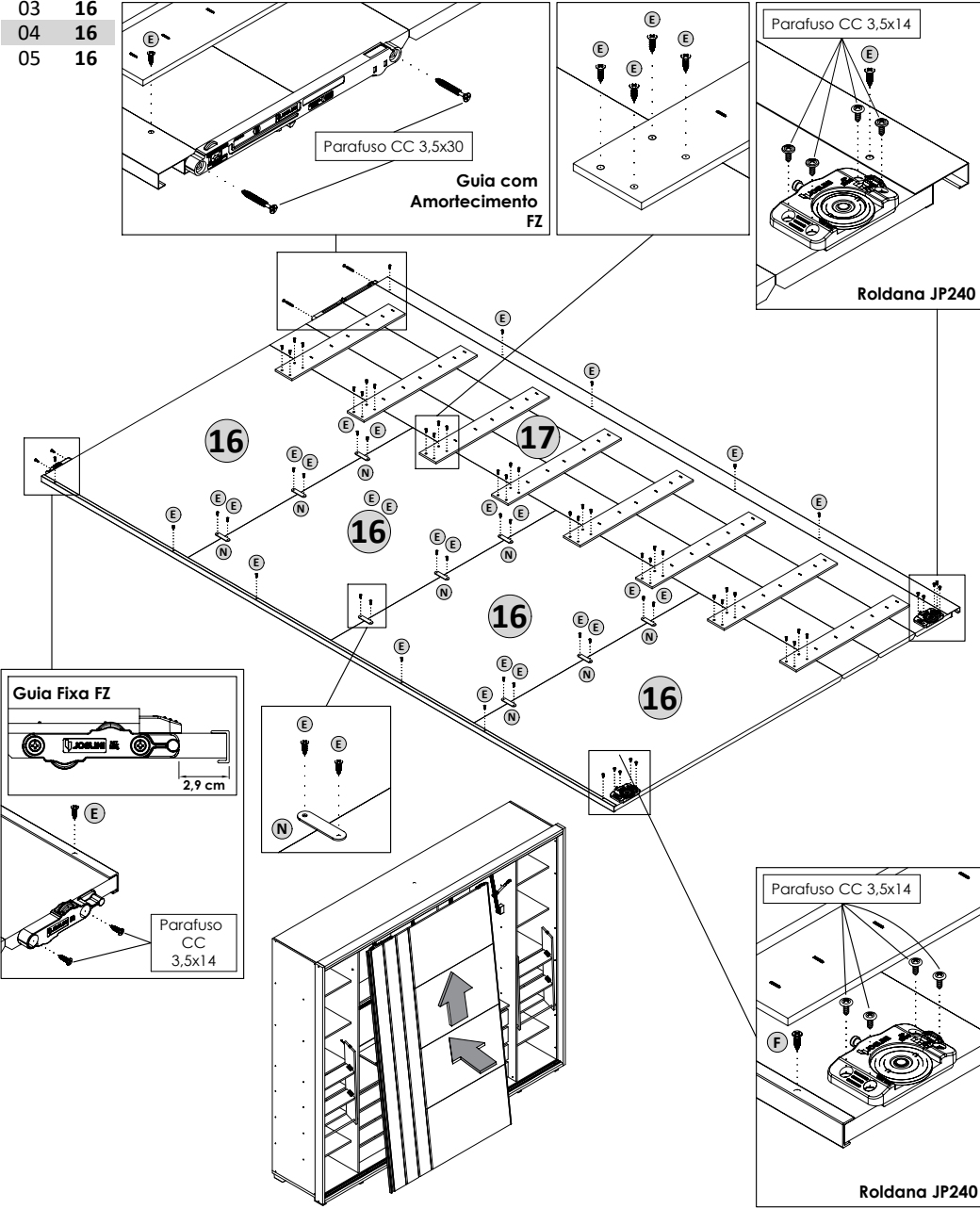

REF.::	CÓDIGO DA PEÇA   PART CODE   CÓDIGO DE PIEZA		DESCRÇÃO DA PEÇA PART DESCRIPTION DESCRIPCIÓN DE PIEZA	MATERIA PRIMA FEEDSTOCK	DIMENSÕES DIMENSIONS DIMENSIONES	QUANT. AMOUNT CANTIDAD
	CUMARU	CINAMOMO OFF WHITE				
01	204037.037	204037.037	Base   Base	MDF	2701 x 540 x 15	1
02	204038.037	204038.037	Prateleira   Shelf   Estante	MDF	450 x 438 x 15	6
03	204039.037	204039.037	Prateleira menor   Smaller shelf   Estante más pequeña	MDF	438 x 401 x 15	6
04	204040.037	204040.037	Prateleira do gaveteiro   Drawer shelf   Estante de cajón	MDF	449 x 432 x 15	2
05	204041.037	204041.037	Prateleira central   Central shelf   Estante central	MDF	890 x 195 x 15	2
06	204042.037	204042.037	Chapéu   Top panel   Panel superior	MDF	2701 x 540 x 15	1
07	204196.037	204196.037	Lateral esquerda   Left side panel   Panel lateral izquierdo	MDF	2300 x 540 x 15	1
08	204197.037	204197.037	Lateral da escada   Side of the staircase   Lateral de la escalera	MDF	755 x 109 x 15	4
09	204198.037	204198.037	Divisão esquerda   Left division   División izquierda	MDF	2270 x 529 x 15	1
10	204199.037	204199.037	Lateral de gaveta   Drawer side panel   Panel lateral del cajón	MDF	415 x 118 x 15	16
11	204200.037	204200.037	Divisão esquerda menor   Smaller left section   División izquierda más pequeña	MDF	415 x 118 x 15	1
12	204222.037	204222.037	Divisão central   Central division   División central	MDF	723 x 450 x 15	1
13	204201.037	204201.037	Divisão direita menor   Smaller right section   División derecha más pequeña	MDF	723 x 450 x 15	1
14	204202.037	204202.037	Divisão direita   Right division   División derecha	MDF	2270 x 529 x 15	1
15	204203.037	204203.037	Lateral direita   Right side panel   Panel lateral derecho	MDF	2300 x 540 x 15	1
16	204204.037	204204.026	Panel maior da porta   Larger panel of the door   Panel más grande de la puerta	MDF	905 x 568 x 15	8
17	204205.037	204205.026	Panel chanfrado da porta   Chamfered panel of the door   Panel chaffinado puerta	MDF	2272 x 435 x 15	2
18	204209.037	204209.037	Fronte de gaveta   Drawer front panel   Panel frontal del cajón	MDF	422 x 146 x 15	8
19	204210.037	204210.037	Contra fundo de gaveta   Drawer back panel   Panel trasero del cajón	MDF	377 x 100 x 15	8
20	204211.037	204211.037	Perfil H menor   Smaller H-profile   Perfil H más pequeño	MDF	442 x 56 x 15	2
21	204212.037	204212.037	Perfil H maior   Larger H-profile   Perfil H más grande	MDF	889 x 56 x 15	4
22	204213.037	204213.037	Rodapé lateral   Side support of the base   Soporte lateral de la base	MDF	515 x 72 x 25	2
23	204214.009	204214.009	Rodapé central   Central base support   Soporte base central	MDF	250 x 72 x 25	6
24	204215.037	204215.037	Base escada   Stair base   Base de la escalera	MDF	377 x 100 x 25	4
25	204216.037	204216.037	Moldura inferior/superior   Bottom/Top Frame   Bisel inferior/superior	MDF	2731 x 87 x 25	2
26	204032.037	204032.037	Moldura lateral   Side frame   Marco lateral	MDF	2350 x 87 x 25	2
27	204217.037	204217.037	Fundo de gaveta   drawer bottom   Fondo del cajón	MDF	420 x 390 x 3	8
28	204218.037	204218.037	Fundo lateral   Side back panel   Panel trasero lateral	MDF	2297 x 458 x 3	2
29	204219.037	204219.037	Fundo inferior menor   Smaller bottom back   Fondo inferior más pequeño	MDF	682 x 458 x 3	2
30	204220.037	204220.037	Fundo inferior maior   Larger bottom back   Fondo inferior más grande	MDF	727 x 447 x 3	2
31	204221.037	204221.037	Fundo superior central   Central upper back   Fondo superior central	MDF	1810 x 493 x 3	3

LEGENDA DAS CORES | COLOR LEGEND | LEYENDA DE COLOR

009 - SEM PINTURA | UNPAINTED | SIN PINTAR

026 - OFF WHITE

037 - CINAMOMO







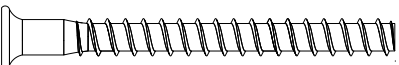

039 - CUMARU

040 - OPALA

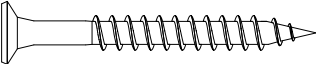
# ACESSÓRIOS | ACCESSORIES | ACESORIOS

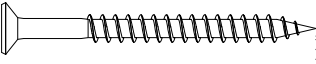
## PARAFUSOS | Screw | Tornillo

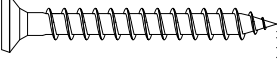

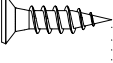
## CÓDIGO | CODE

<b>A</b>			<b>Parafuso   Screw   Tornillo 5,0x50 (Estrutural)</b>	<b>74x</b>	<b>102100045</b>
<b>B</b>			<b>Parafuso   Screw   Tornillo 4,5x40</b>	<b>20x</b>	<b>102100001</b>
<b>C</b>			<b>Parafuso   Screw   Tornillo 3,5x40</b>	<b>32x</b>	<b>102100012</b>
<b>D</b>			<b>Parafuso   Screw   Tornillo 4,0x35</b>	<b>40x</b>	<b>102100038</b>
<b>E</b>			<b>Parafuso   Screw   Tornillo 3,5x14</b>	<b>380x</b>	<b>102100003</b>



## RELAÇÃO DE COR DOS ACESSÓRIOS

Color ratio of accessories | Relación de color de los accesorios

LETRA LETTER	DESCRIÇÃO DESCRIPTION DESCRIPCIÓN	MATÉRIA PRIMA FEEDSTOCK	COR COLOR	QUANT.   AMOUNT CANTIDAD			CÓDIGO CODE
				CINAMOMO	CINAMOMO OFF WHITE	CUMARU OPALA	
<b>F</b>	 <b>Tapa furo adesivo 18mm</b> Adhesive hole cover 18mm Tapa agujero adhesivo 18mm	<b>Papel</b> Paper	<b>Cinamomo</b>	<b>180</b>	<b>180</b>		<b>102080216</b>
			<b>Cumaru</b>			<b>180</b>	<b>102080288</b>
			<b>Bronze Dark</b>	<b>12</b>	<b>12</b>	<b>12</b>	<b>102080298</b>
<b>G</b>	 <b>Giz p/ correção</b> Touch-up chalk Tiza correctora	<b>Cera</b> Wax	<b>Cinamomo</b>	<b>1</b>	<b>1</b>		<b>102140023</b>
			<b>Off white</b>		<b>1</b>		<b>102140008</b>
			<b>Cumaru</b>			<b>1</b>	<b>102140026</b>
			<b>Opala</b>			<b>1</b>	<b>102140025</b>
<b>H</b>	 <b>Mini sapata 15x15mm</b> Feet pads 15x15mm Minizapato 15x15mm	<b>Plástico</b> Plastic	<b>Cinamomo</b>	<b>4</b>	<b>4</b>		<b>102060145</b>
			<b>Cumaru</b>			<b>4</b>	<b>102060148</b>

# ATENÇÃO!!

Fixar os cabideiros extensíveis antes de colocar as portas

## ATTENTION!!



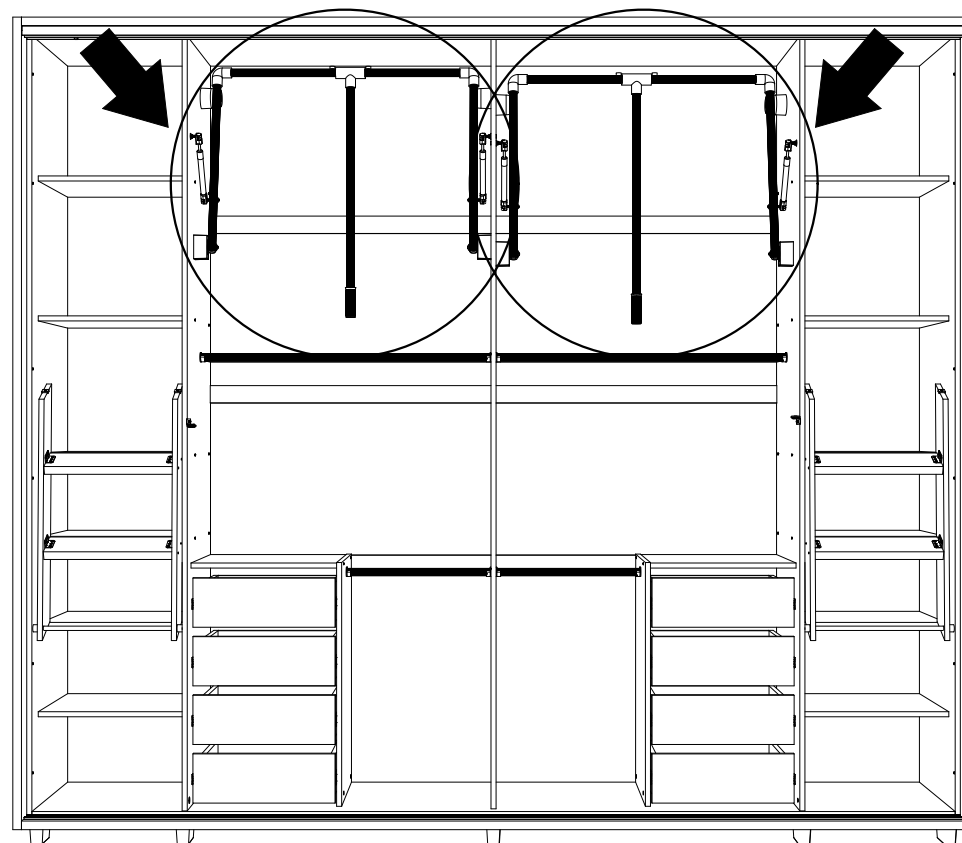

Fix the pull-out hangers before installing the doors

## ATENCION!!

Coloque las perchas extensibles antes de colocar las puertas

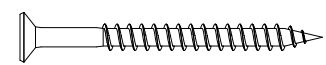
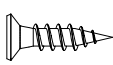

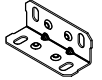

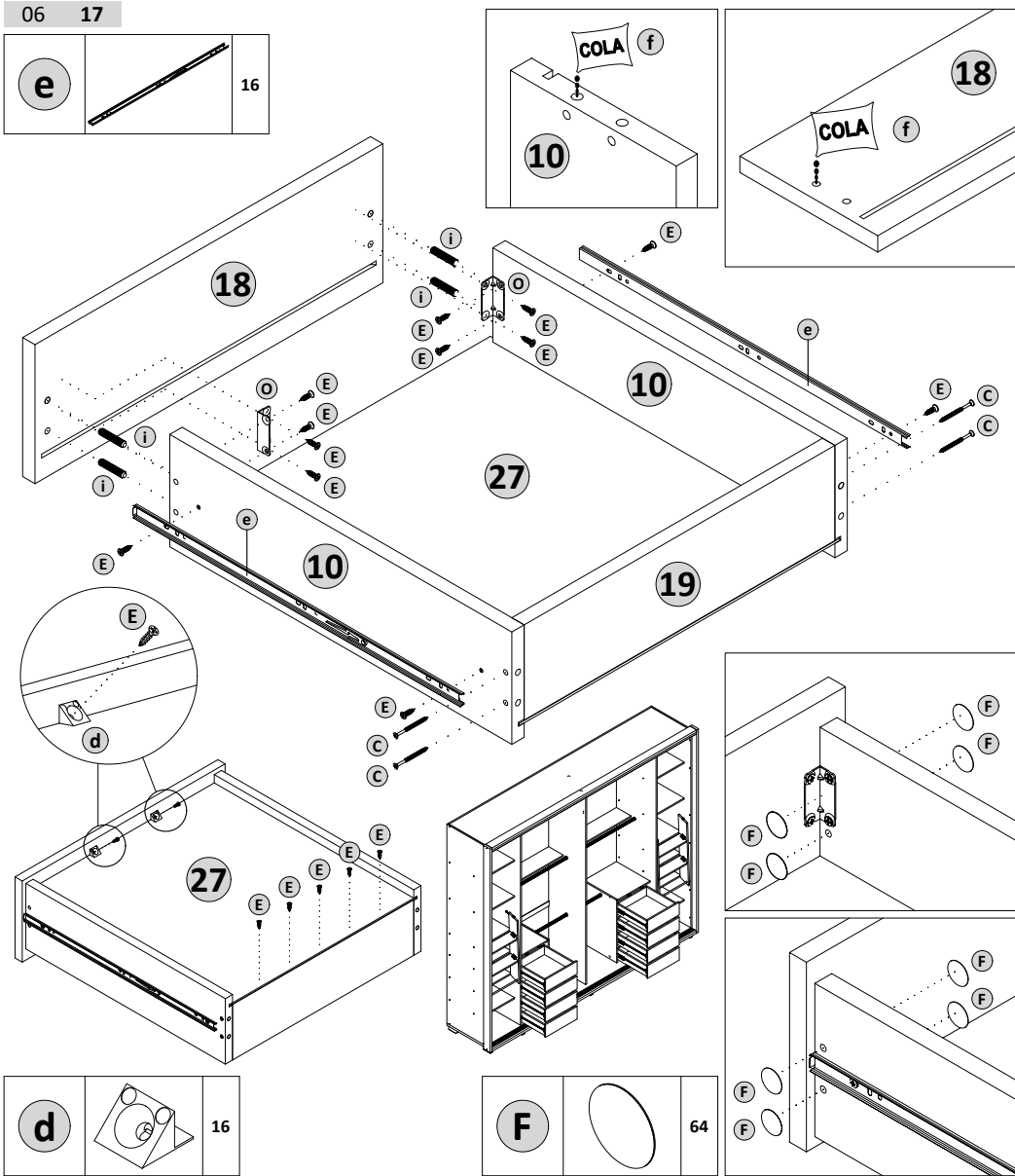

**19º PASSO | PASS | PASO**

<b>PEÇAS PIECES PIEZAS</b>		<b>C</b>		32	<b>E</b>		152
<b>S.M.</b>	<b>C.P.</b>	<b>i</b>		32	<b>O</b>		16
01	17	<b>f</b>			<b>f</b>		4
02	17						
03	17						
04	17						
05	16						
06	17						

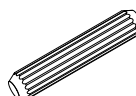
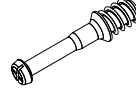
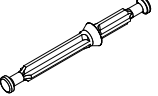
**MONTAGEM DAS GAVETAS | DRAWER ASSEMBLY | MONTAJE DEL CAJÓN**

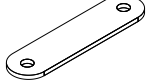
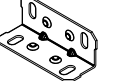
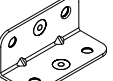

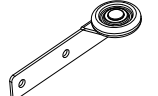
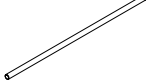
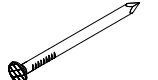
LETRA LETTER	DESCRIÇÃO   DESCRIPTION   DESCRIPCIÓN	MATÉRIA PRIMA FEEDSTOCK	QUANTIDADE AMOUNT CANTIDAD	CÓDIGO CODE
<b>i</b>	 <b>Cavilha 6x30mm</b> Dowel 6x30mm Clavija 6x30mm	Madeira Wood Madera	70	102050001
<b>J</b>	 <b>Pino girofix 5,0x30mm</b> Girofix pin 5,0x30mm Pino girofix 5,0x30mm	Metal	10	102050007
<b>K</b>	 <b>Pino girofix haste dupla 62x8mm</b> Girofix double stem 62x8mm Giro-fijo asta doble 62x8mm	Metal	1	102050008
<b>L</b>	 <b>Castanha girofix 12x10mm</b> Girofix chestnut 12x10mm Castaña girofix 12x10mm	Metal	12	102050006
<b>M</b>	 <b>Chapa fixador de fundo</b> Bottom fixing plate Placa fijadora de fondo	Metal	65	102050002
<b>N</b>	 <b>Chapa fixadora 50x13</b> Fixing plate 50x13 Placa fijadora 50x13	Metal	18	102050018
<b>O</b>	 <b>Cantoneira aço 17,5x17,5x46mm zincada</b> Angle steel 17.5x17.5x46mm zinc-plated Ángulo de acero 17,5x17,5x46mm cincado	Metal	16	102050041
<b>P</b>	 <b>Cantoneira 4 furos 47x22mm zincada</b> Angle bracket 4 holes 47x22mm zinc plated Escuadra 4 agujeros 47x22mm cincada	Metal	8	102100064
<b>Q</b>	 <b>Aldrava com pitão 16x50</b> Knocker with stud 16x50 Aldaba con perno 16x50	Metal	2	102050049
<b>R</b>	 <b>Roldana Anti-Empenamento</b> Anti-Bending Pulley Polea anti-flexión	Metal	2	102050050
<b>S</b>	 <b>Tubo Redondo 458mm 1/2" polegada alumínio</b> Round Tube 18,0315" 1/2" inch aluminum Tubo Redondo 18,0315" 1/2" pulgadas aluminio	Metal	2	102050050
<b>T</b>	 <b>Prego 10x10</b> Nail 10x10 Clavo 10x10	Metal	210	102100009

<b>U</b>		<b>Suporte cabideiro redondo</b> Round coat rack Perchero redondo	<b>Metal</b>	<b>8</b>	<b>102060153</b>
<b>V</b>		<b>Tubo cinza 1/2 polegada (15mm)</b> Gray tube 1/2 inch (15mm) Tubo gris 1/2 pulgada (15 mm)	<b>PVC</b> Cloruro de polivinilo	<b>4</b>	<b>102070067</b>
<b>W</b>		<b>Trilho inferior Rx 1053 Bronze 1002</b> Lower rail Rx 1053 Bronze 1002 Riel inferior Rx 1053 Bronze 1002	<b>Metal</b>	<b>1</b>	<b>102070685</b>
<b>X</b>		<b>Trilho superior Rx 1021 Bronze 1002</b> Top rail Rx 1021 Bronze 1002 Riel superior Rx 1021 Bronze 1002	<b>Metal</b>	<b>1</b>	<b>102070683</b>
<b>Y</b>		<b>Perfil puxador Rx 1026 bronze 1002</b> Handle profile Rx 1026 bronze 1002 Perfil tirador Rx 1026 bronze 1002	<b>Metal</b>	<b>2</b>	<b>102050052</b>
<b>Z</b>		<b>Perfil U Anti-empenamento Bronze Dark</b> Dark Bronze Anti-Warp U Profile Perfil en U antideformación de bronce oscuro	<b>Metal</b>	<b>2</b>	<b>102050051</b>
<b>a</b>		<b>Tubo redondo estriado 437mm</b> Ribbed round tube 437mm Tubo redondo acanalado 437mm	<b>Metal</b>	<b>2</b>	<b>102050057</b>
<b>b</b>		<b>Tubo redondo estriado 884mm</b> Ribbed round tube 884mm Tubo redondo acanalado 884mm	<b>Metal</b>	<b>2</b>	<b>102050055</b>
<b>c</b>		<b>Pé de plástico</b> Plastic foot Pie de plástico	<b>Plástico</b> Plastic	<b>10</b>	<b>102110038</b>
<b>d</b>		<b>Suporte triangular p/ fundo de gaveta</b> Triangular support for drawer bottom Soporte triangular para fondo de cajón	<b>Plástico</b> Plastic	<b>16</b>	<b>102050037</b>
<b>e</b>		<b>Corrediça Telescópica</b> Telescopic Slide Diapositiva telescópica	<b>Metal</b>	<b>8</b>	<b>102010026</b>
<b>f</b>		<b>Sache de cola 12g</b> Sachet of glue 0,42oz Bolsita de pegamento 0,42oz	<b>Cola</b> Glue	<b>2</b>	<b>102050020</b>
<b>g</b>		<b>Etiqueta resinada</b> Resin label Etiqueta en resina	<b>Plástico</b> Plastic	<b>1</b>	<b>102080013</b>

**18º PASSO | PASS | PASO**

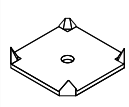
PEÇAS PIECES PIEZAS		
<b>T</b>		<b>210</b>
<b>M</b>		<b>65</b>

S.M.	C.P.
01	29
02	29
03	30
04	30
05	20
06	20
07	31
08	21
09	21
10	31
11	21
12	21
13	31
14	28
15	28

**ATENÇÃO!! | ATTENTION!! | ATENCION!!**

Coloque os cabideiros antes de fixar os fundos  
Place the hangers before attaching the bottoms  
Coloque las perchas antes de colocar los fondos

**Fixação dos fundos**

Back panel instalation  
Fijacion del fondo

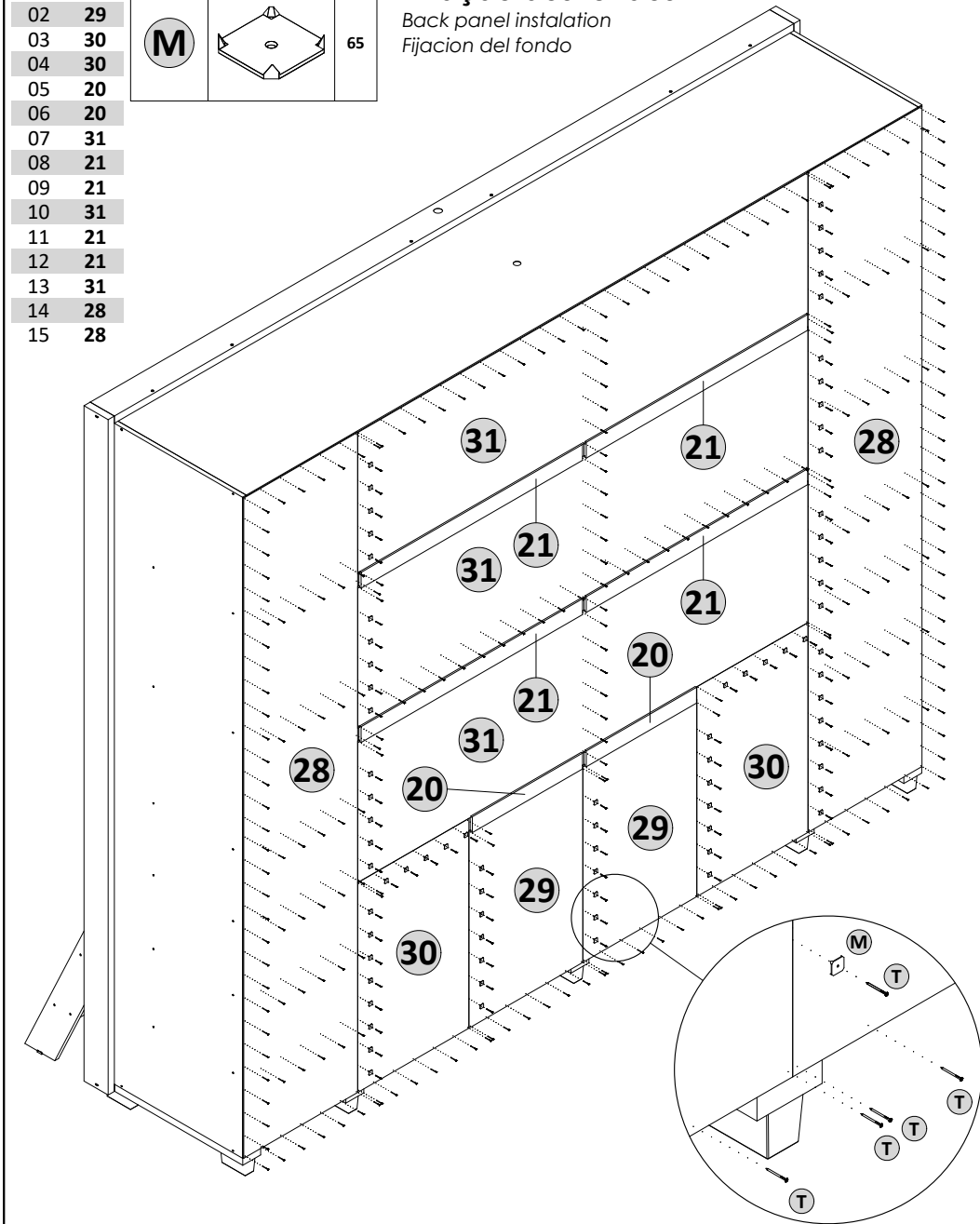

16º PASSO | PASS | PASO

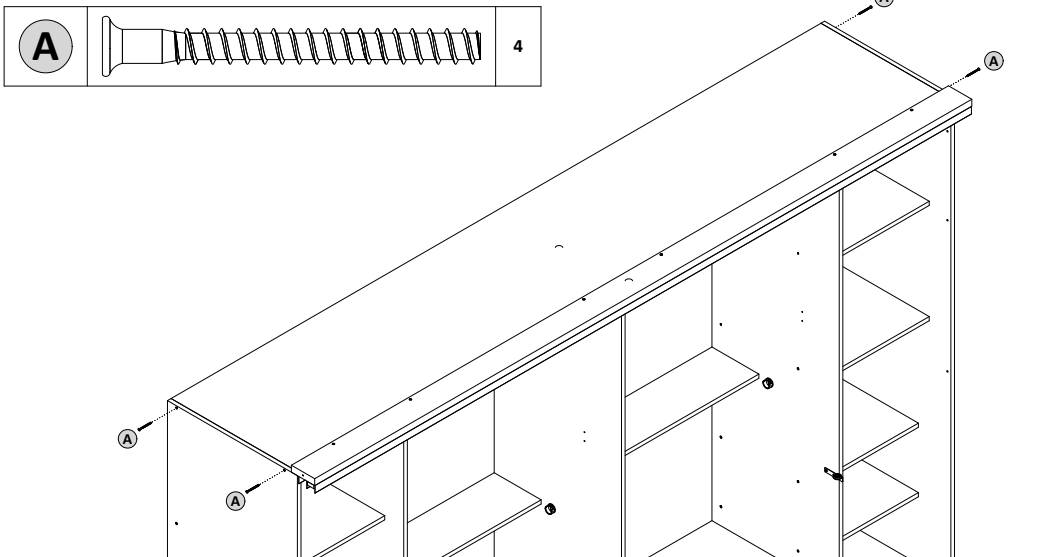

17º PASSO | PASS | PASO

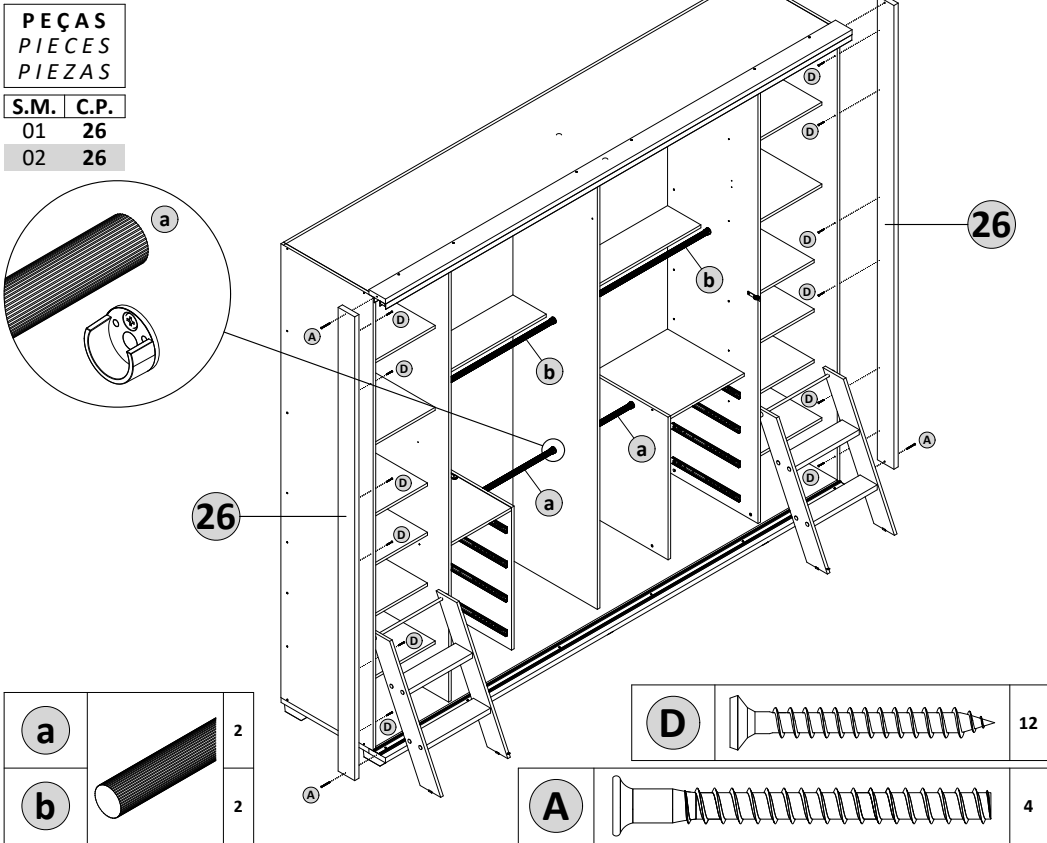

1º PASSO | PASS | PASO

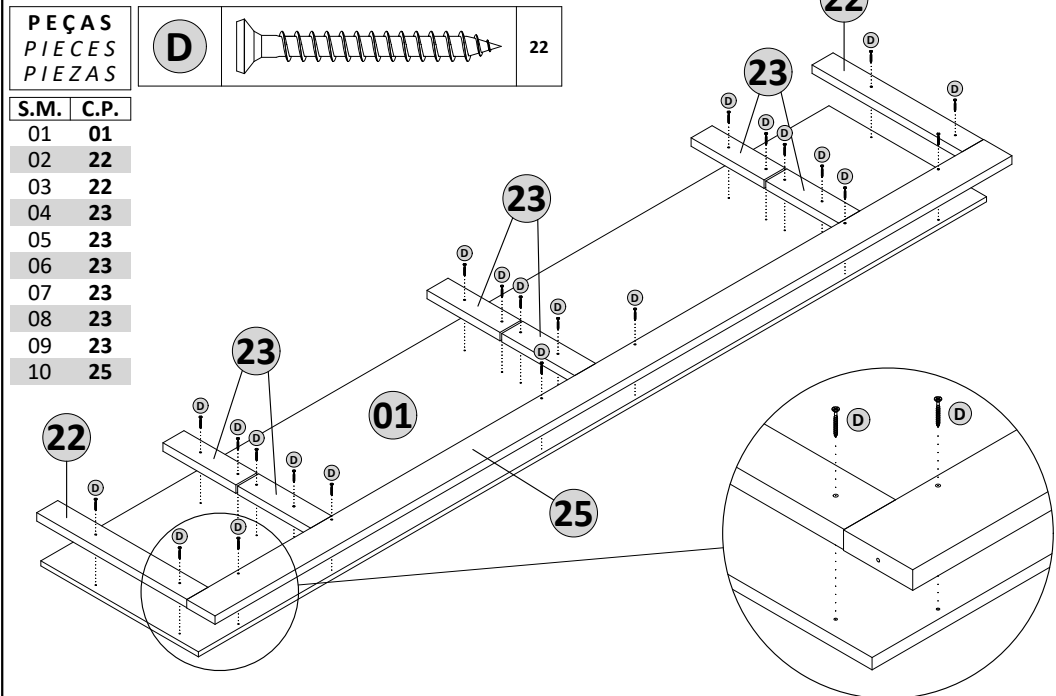

2º PASSO | PASS | PASO

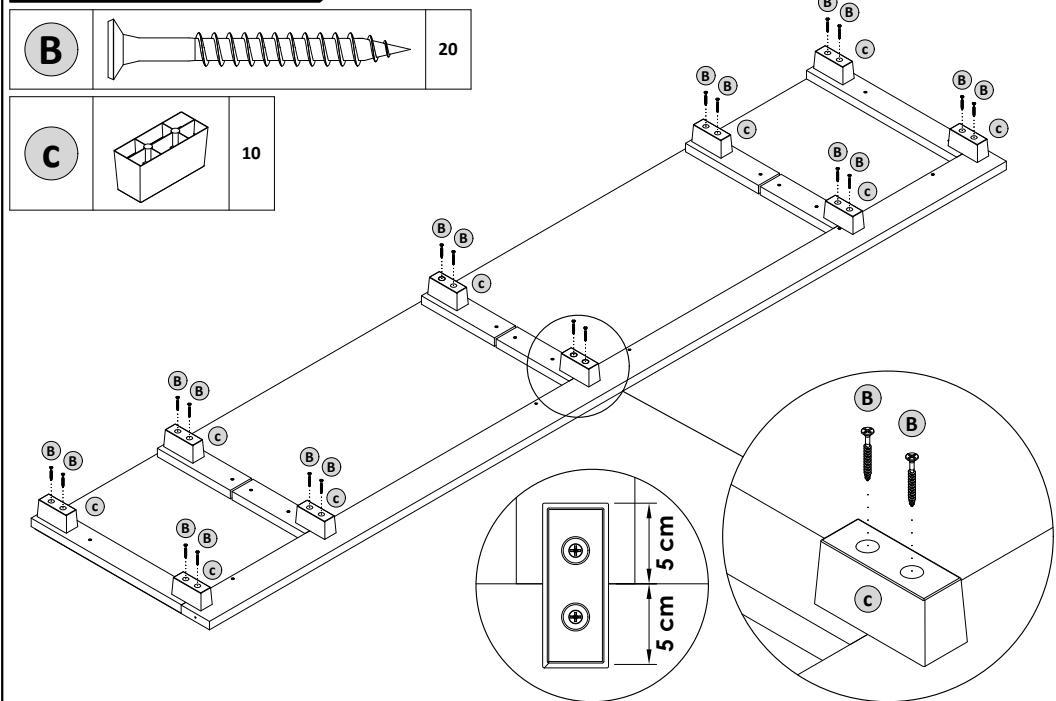

3º PASSO | PASS | PASO

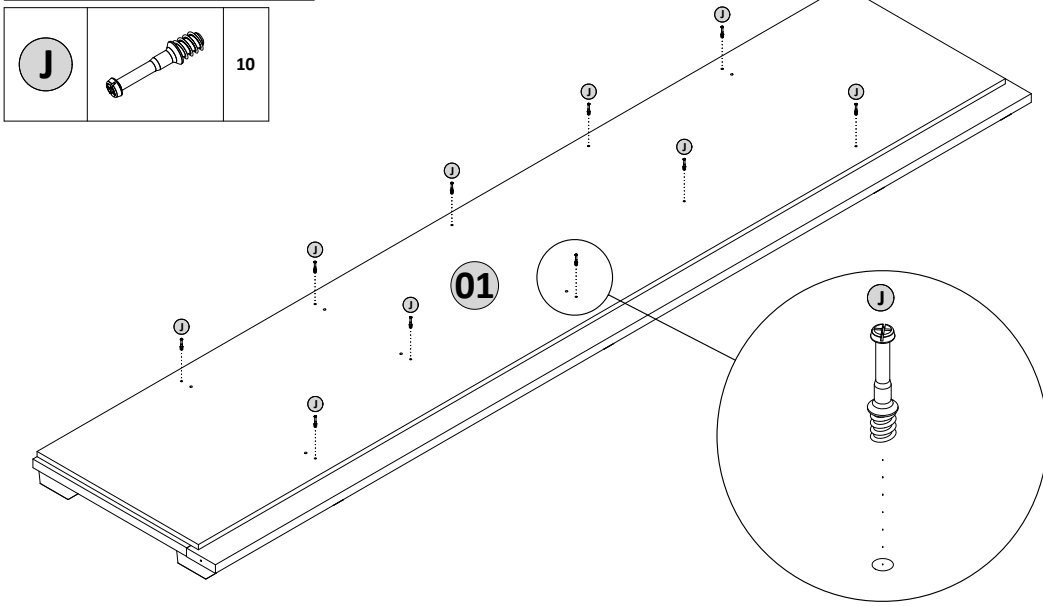

4º PASSO | PASS | PASO

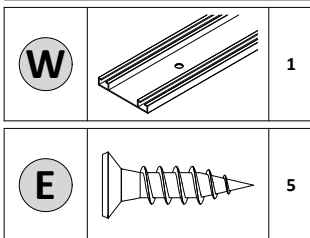

"Fixar o trilho inferior na moldura, encostando-o firmemente na base."

"Secure the lower rail to the frame, ensuring it rests firmly on the base."

"Fijar el riel inferior al marco, asegurando que quede bien apoyado en la base."

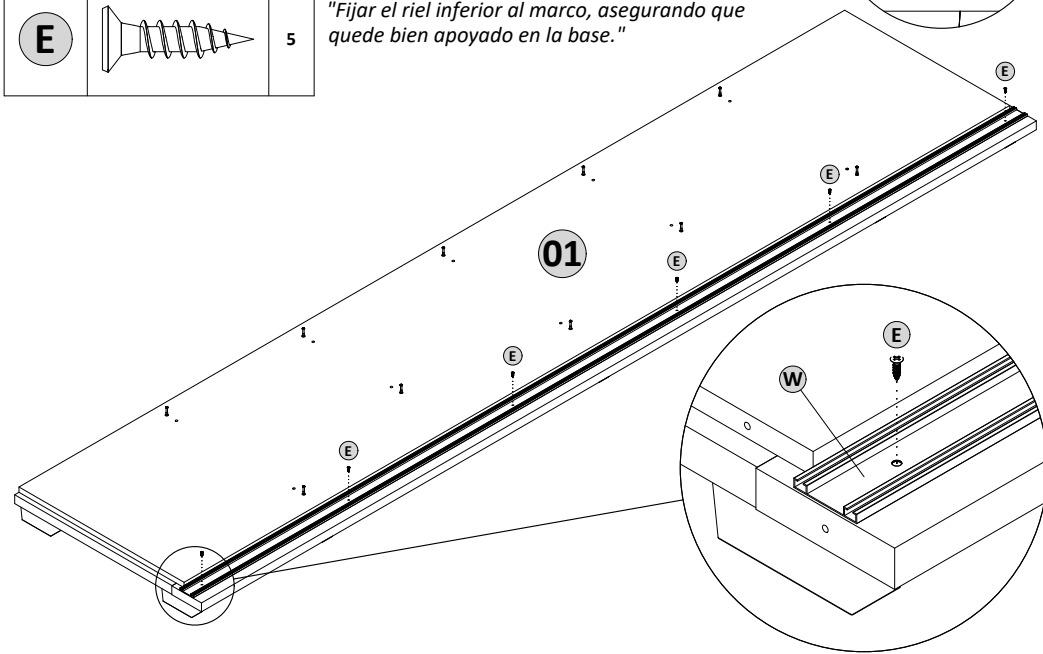

14º PASSO | PASS | PASO

FIXAÇÃO DAS FERRAGENS (TOPE/PESCADOR)

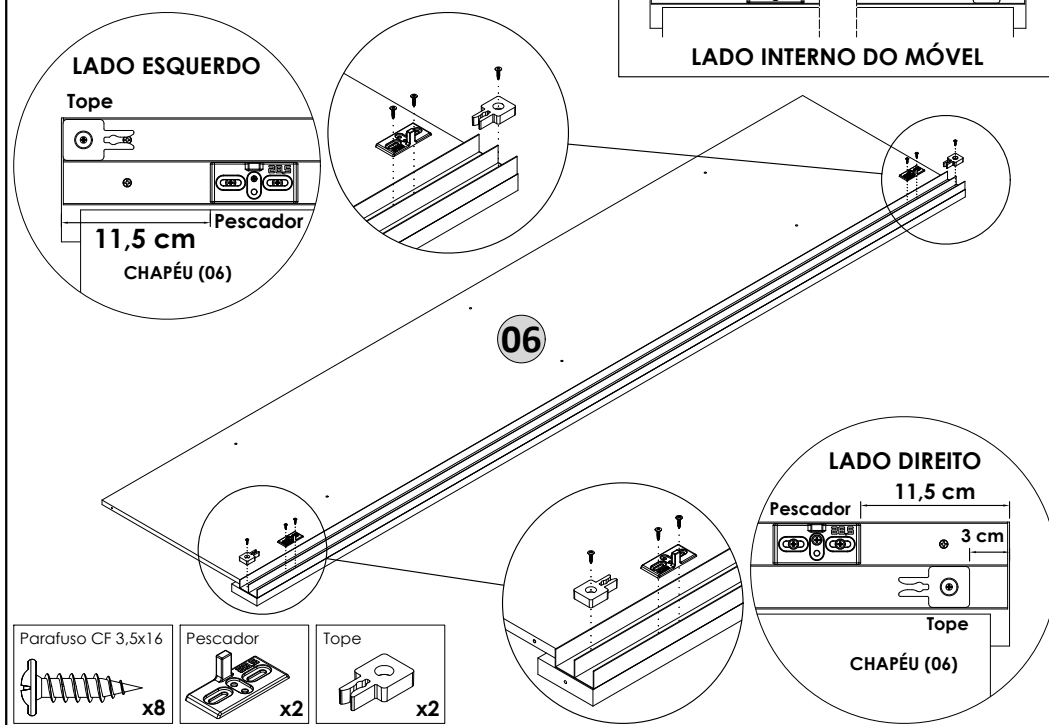

15º PASSO | PASS | PASO

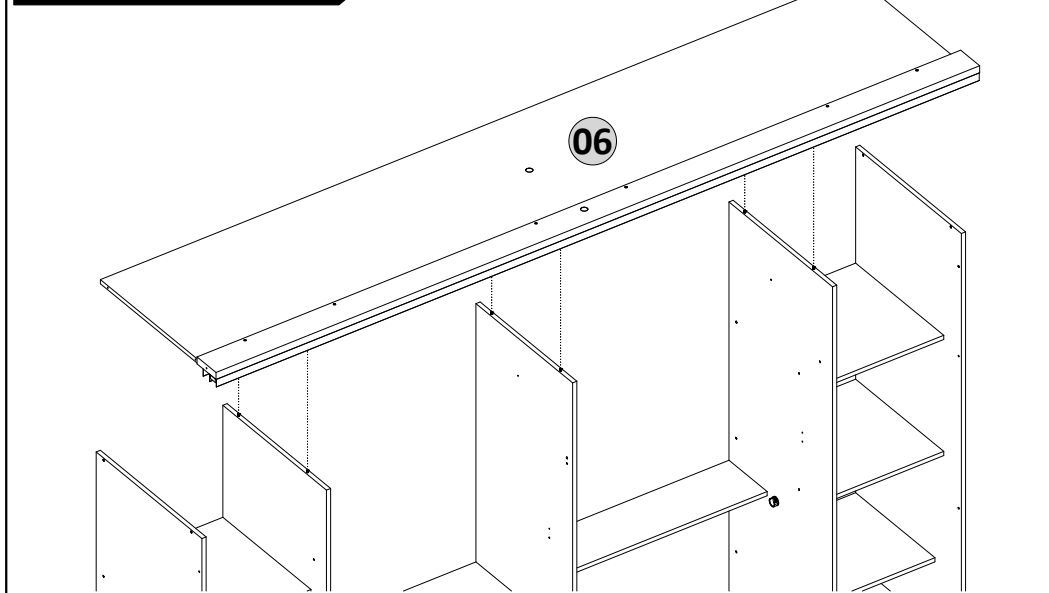

**12º PASSO | PASS | PASO**

**FIXAÇÃO DA MOLDURA NO CHAPÉU**

FIXING THE FRAME TO THE UPPER PANEL  
FIJACIÓN DEL MARCO AL PANEL SUPERIOR

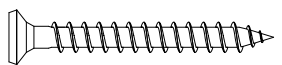
<b>PEÇAS</b>	<b>D</b>		6
<b>PIECES</b>			
<b>PIEZAS</b>			

<b>S.M.</b>	<b>C.P.</b>
01	06
02	25

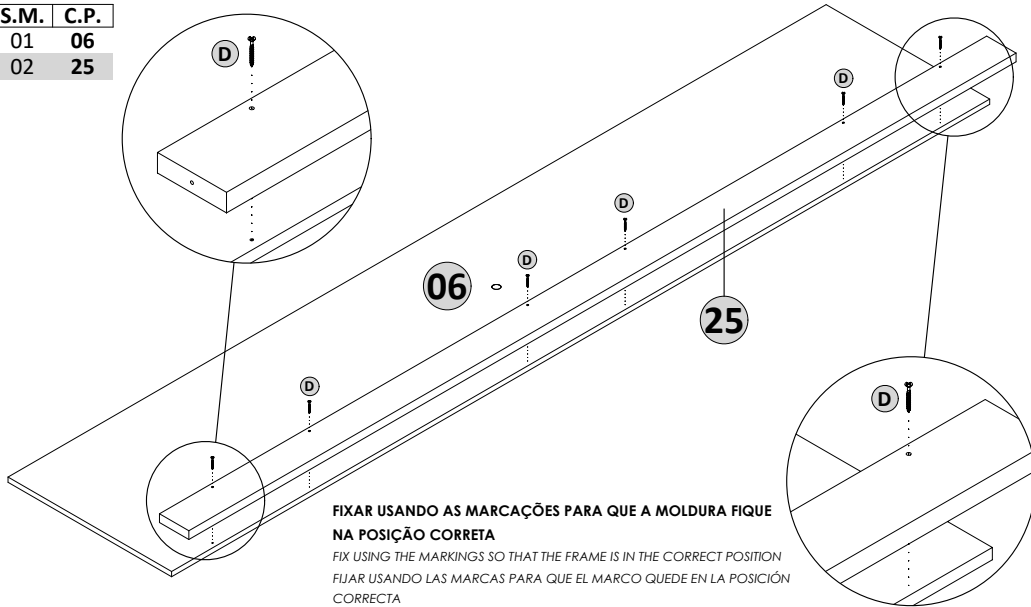

**FIXAR USANDO AS MARCAÇÕES PARA QUE A MOLDURA FIQUE NA POSIÇÃO CORRETA**  
FIX USING THE MARKINGS SO THAT THE FRAME IS IN THE CORRECT POSITION  
FIJAR USANDO LAS MARCAS PARA QUE EL MARCO QUEDE EN LA POSICIÓN CORRECTA

**13º PASSO | PASS | PASO**

"Fixar o **TRILHO SUPERIOR**, alinhando sua face frontal com a borda frontal do chapéu."  
"Fix the upper rail, aligning its front face with the front edge of the cap."  
"Fijar el riel superior, alineando su cara frontal con el borde frontal del sombrero."

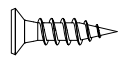
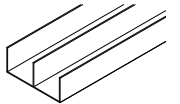

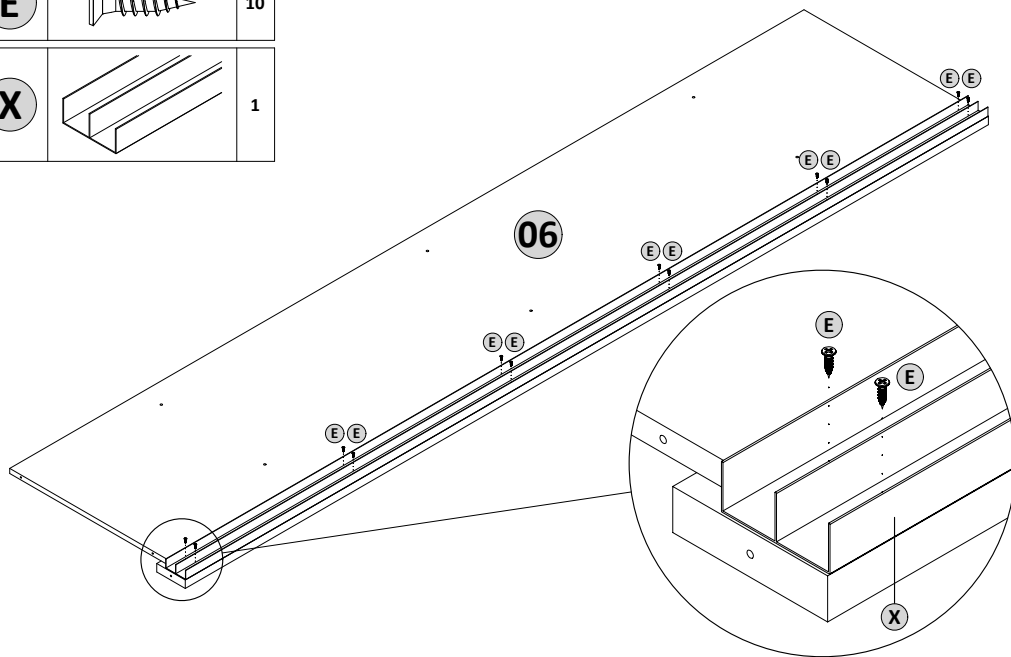
<b>E</b>		10
<b>X</b>		1



**5º PASSO | PASS | PASO**

**PEÇAS**

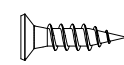
<b>S.M.</b>	<b>C.P.</b>
01	08
02	24
03	24
04	08

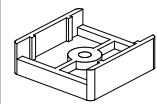
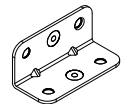



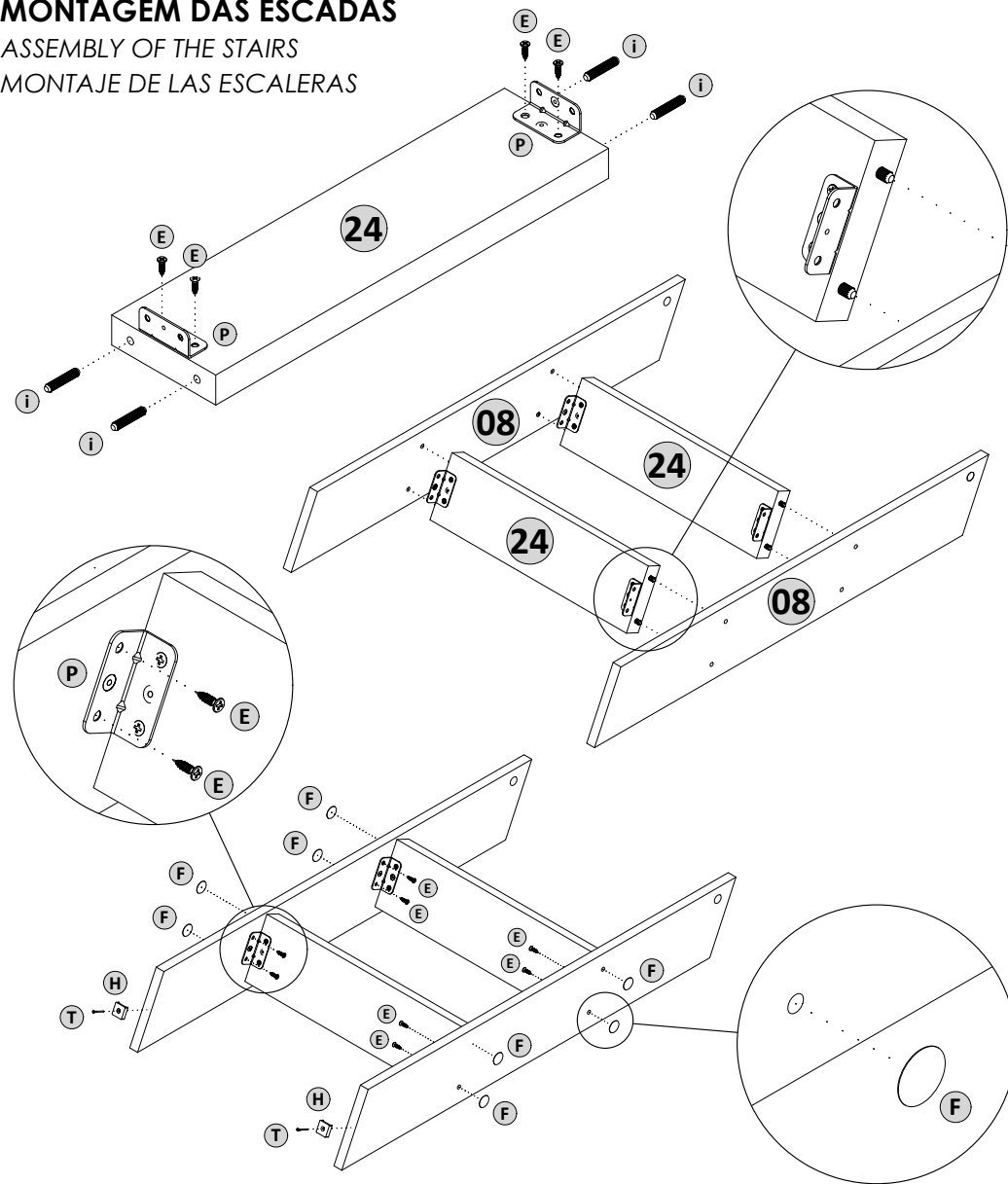

<b>i</b>		16	<b>E</b>		32	<b>T</b>		4
<b>F</b>		16	<b>H</b>		4	<b>P</b>		8

**MONTAGEM DAS ESCADAS**

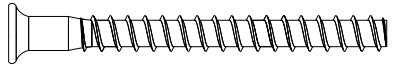
ASSEMBLY OF THE STAIRS  
MONTAJE DE LAS ESCALERAS

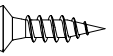



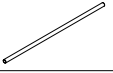

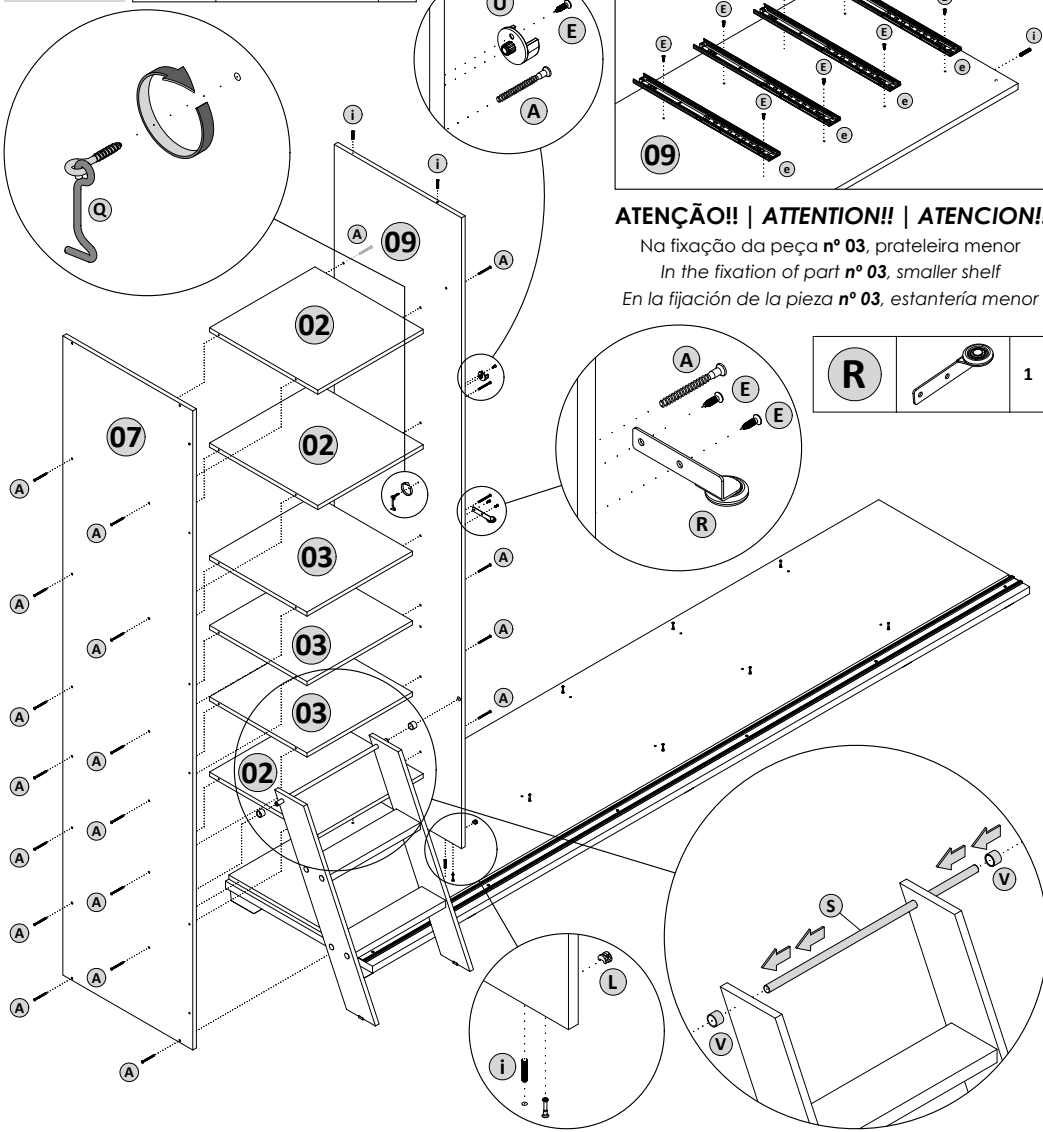
**6º PASSO | PASS | PASO**

PEÇAS PIECES PIEZAS		A		26	Q		1
S.M.	C.P.	E		11	V		2
01	07	i		4	U		1
02	02	L		2	S		1
03	09						
04	03						
05	03						
06	03						
07	02						
08	02						

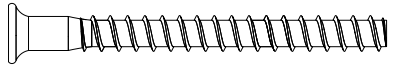
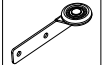

**ATENÇÃO!! | ATTENTION!! | ATENCION!!**  
 Na fixação da peça nº 03, prateleira menor  
 In the fixation of part nº 03, smaller shelf  
 En la fijación de la pieza nº 03, estantería menor

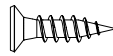
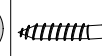
**11º PASSO | PASS | PASO**

PEÇAS PIECES PIEZAS		A		26	R		1	V		2
S.M.	C.P.	E		2	Q		1	S		1
01	15									
02	02									
03	03									
04	03									
05	03									
06	02									
07	02									

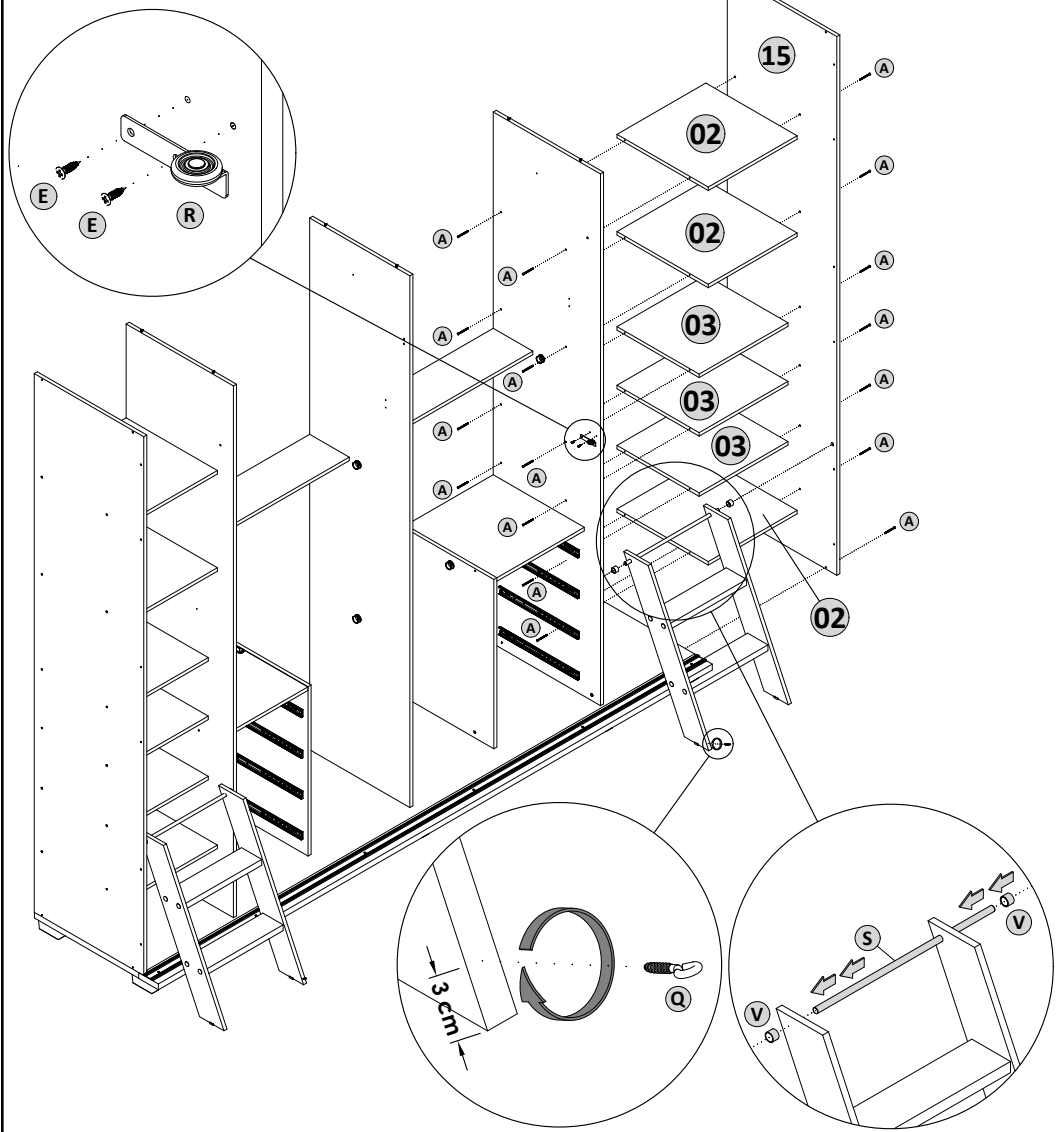

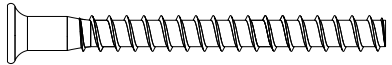

**ATENÇÃO!! | ATTENTION!! | ATENCION!!**  
 Na fixação da peça nº 03, prateleira menor  
 In the fixation of part nº 03, smaller shelf  
 En la fijación de la pieza nº 03, estantería menor

**10º PASSO | PASS | PASO**

PEÇAS PIECES PIEZAS		<b>A</b>		6
---------------------------	--	----------	--	---

S.M.	C.P.	<b>E</b>		9	<b>Q</b>		1
01	14						
02	04						
03	05						

<b>i</b>		6	<b>U</b>		1
----------	---	---	----------	---	---

<b>L</b>		2	<b>e</b>		4
----------	---	---	----------	---	---

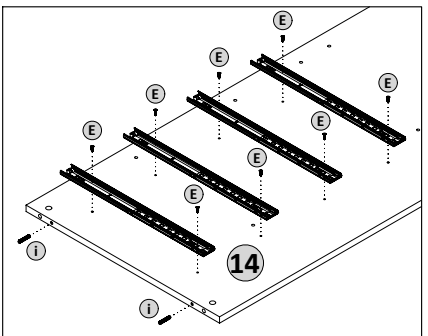
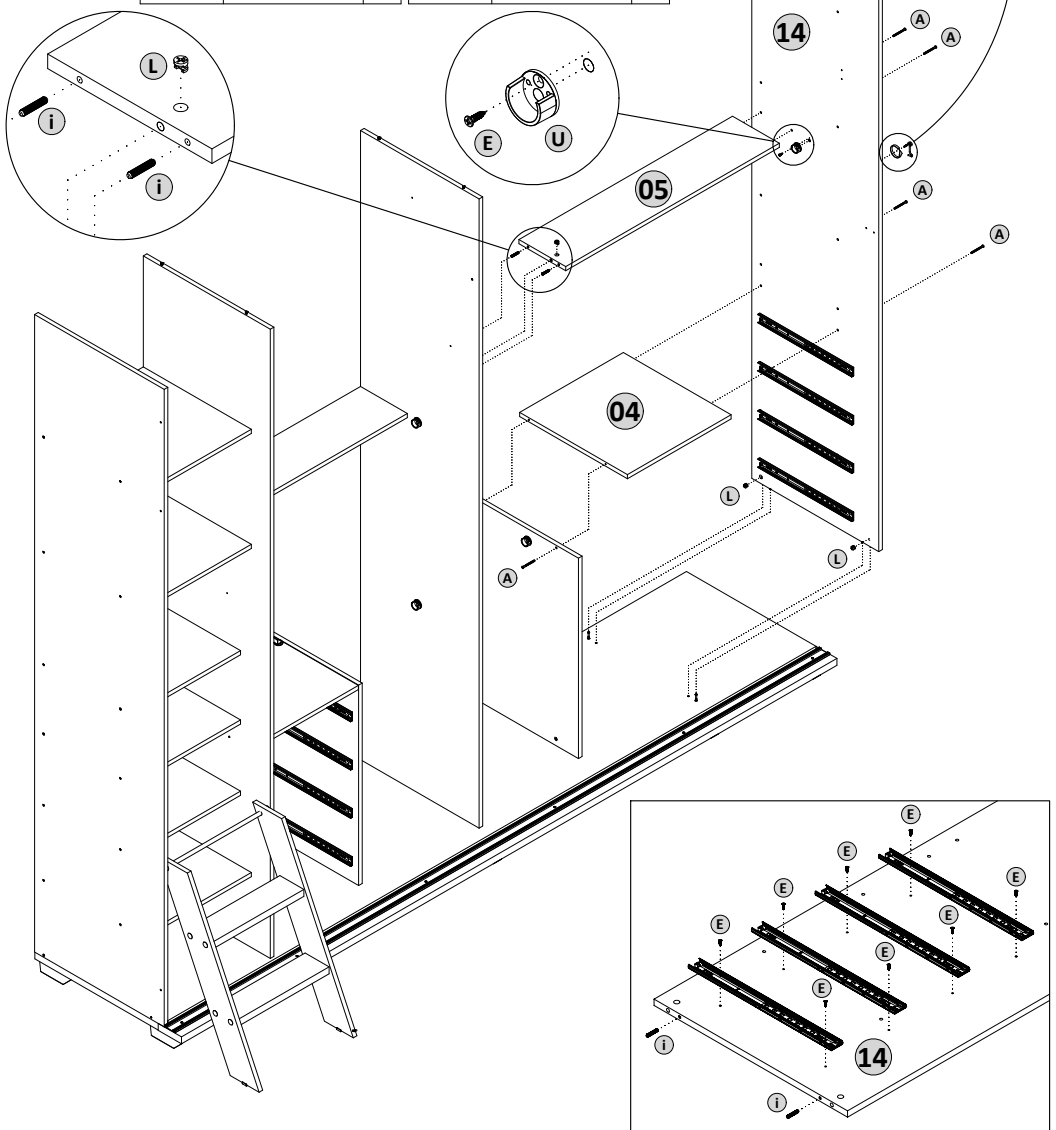

**7º PASSO | PASS | PASO**

PEÇAS PIECES PIEZAS		<b>L</b>		2
---------------------------	--	----------	--	---

S.M.	C.P.	<b>U</b>		1
01	11			
02	04			

<b>E</b>		9
----------	---	---

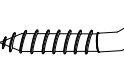
<b>Q</b>		1
----------	---	---

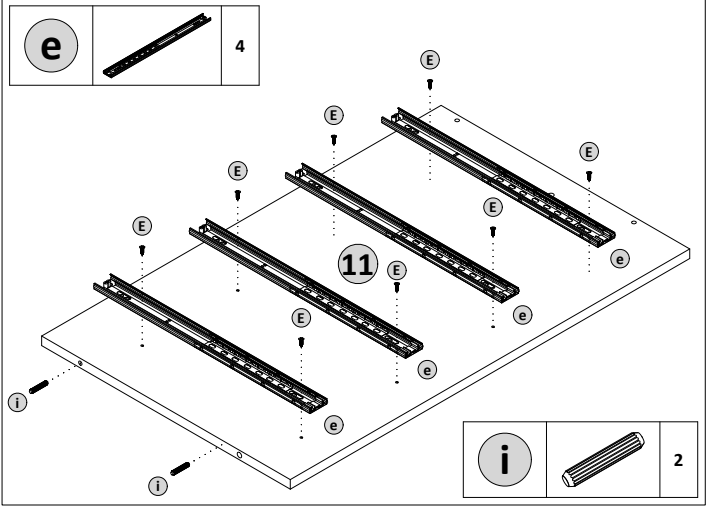
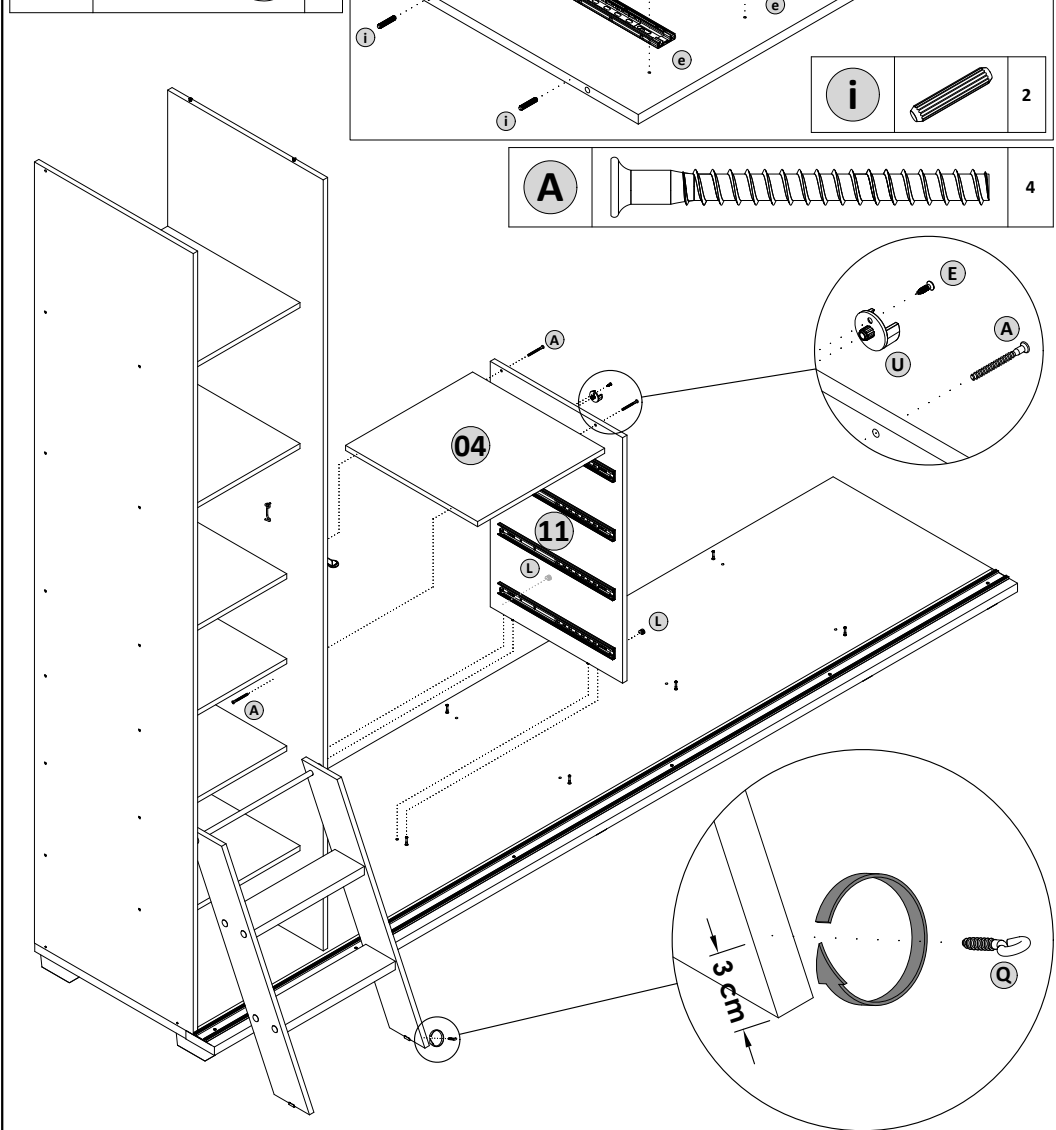

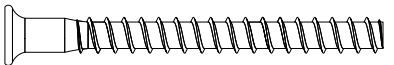
<b>A</b>		4
----------	---	---

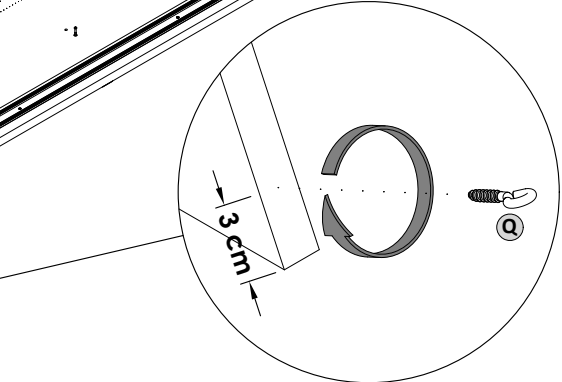
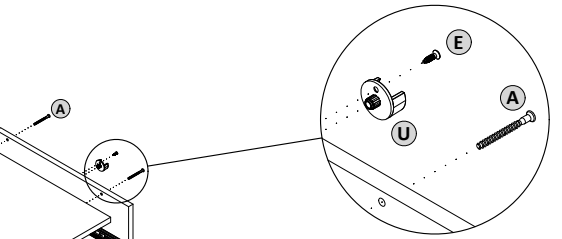

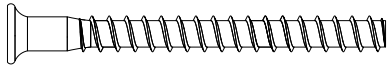
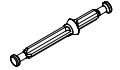

8º PASSO | PASS | PASO

PEÇAS  
PIECES  
PIEZAS

<b>A</b>		2	<b>K</b>		2
----------	--	---	----------	--	---

S.M.	C.P.
01	12
02	05

<b>E</b>		4	<b>U</b>		4
----------	---	---	----------	---	---

<b>i</b>		6	<b>L</b>		2
----------	---	---	----------	---	---

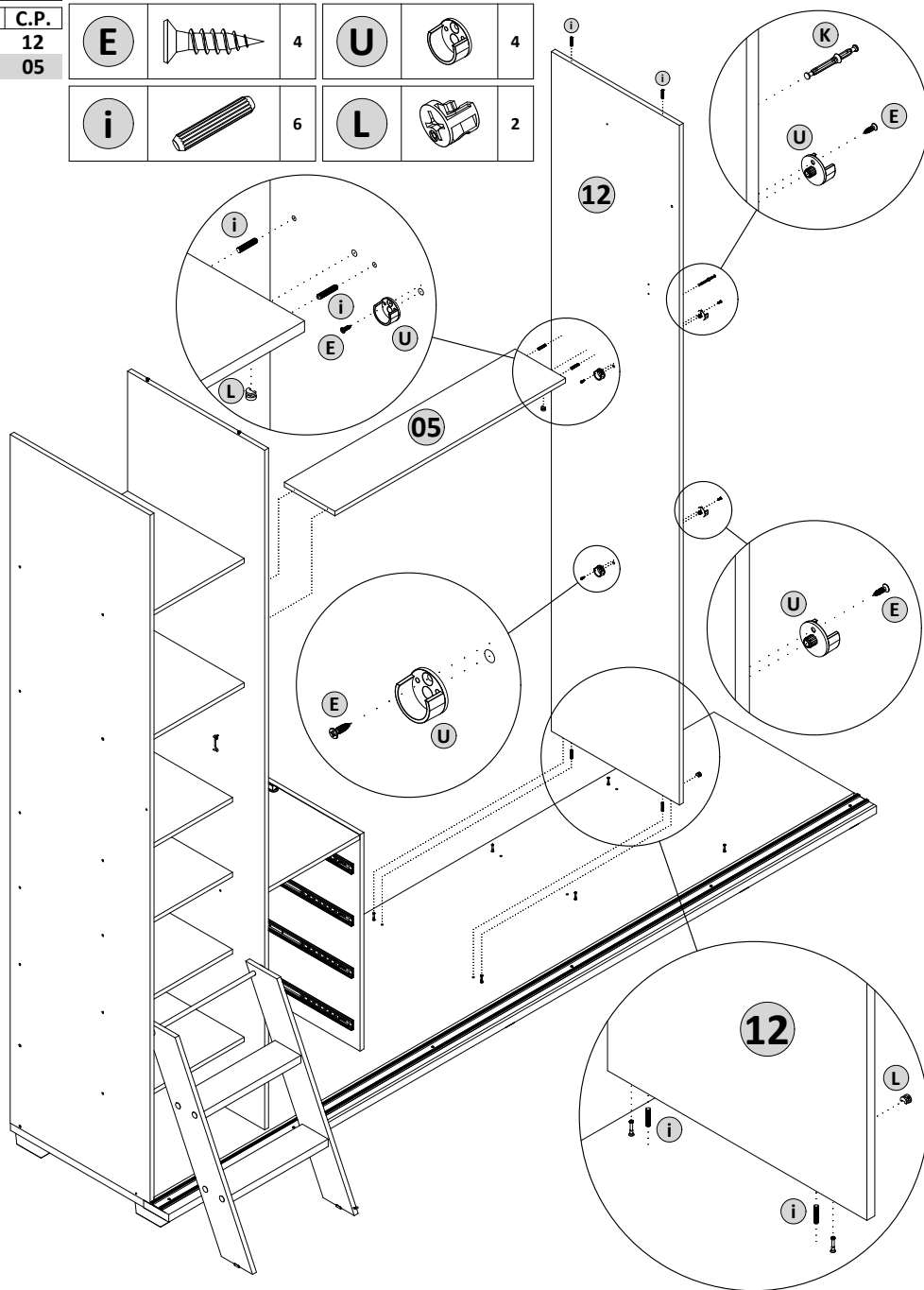

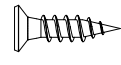

9º PASSO | PASS | PASO

PEÇAS  
PIECES  
PIEZAS

<b>E</b>		9
----------	--	---

S.M.	C.P.
01	13

<b>i</b>		2
----------	---	---

<b>L</b>		2
----------	---	---

<b>U</b>		1
----------	---	---

<b>e</b>		4
----------	---	---

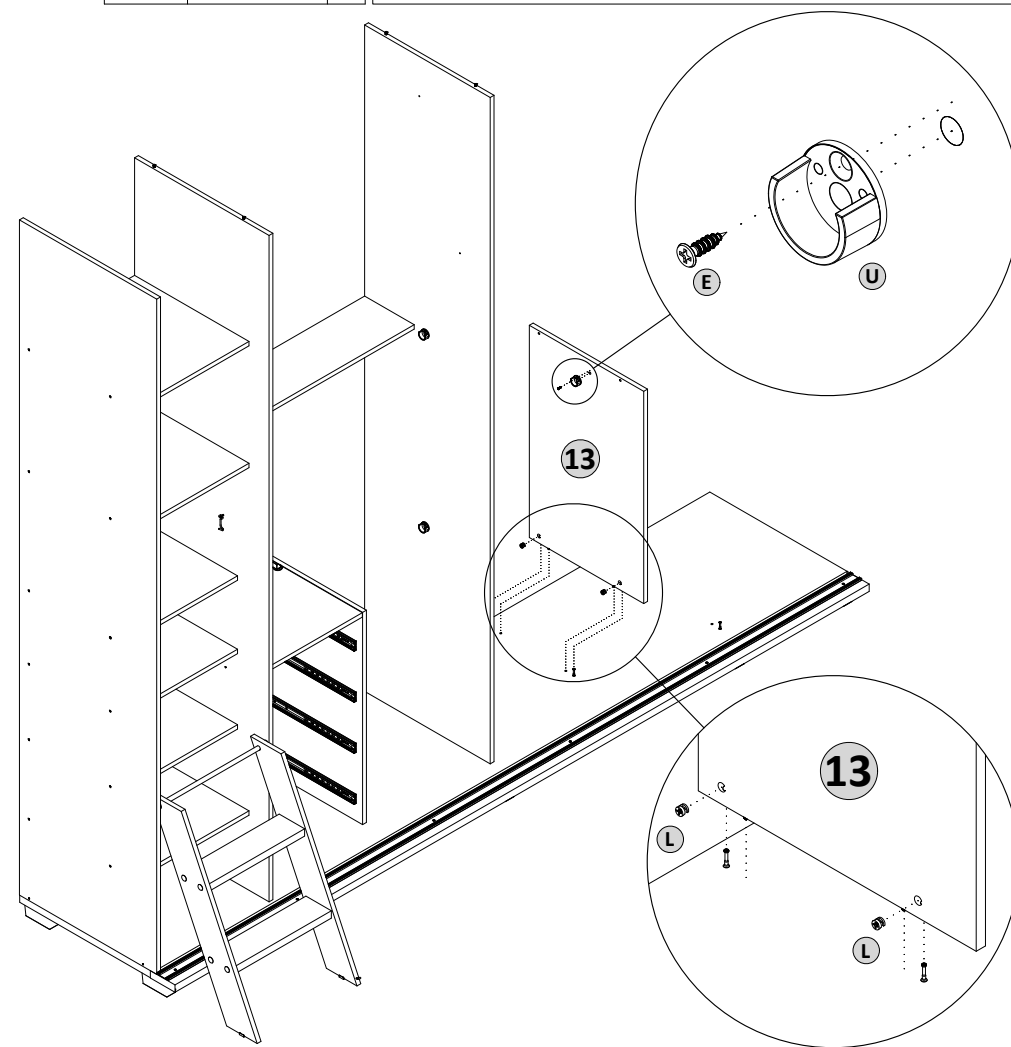
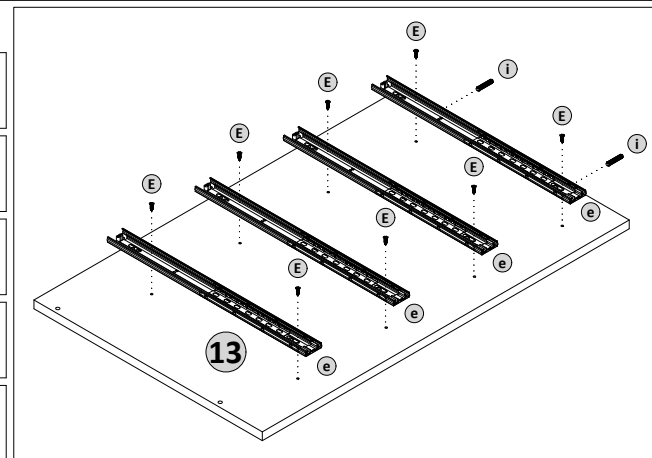

# Agora que você já comprou o seu móvel, ele merece ser montado do jeito certo.

Erros de montagem causam mais de **60%** dos danos em móveis.

## Por que contratar?

Tranquilidade do **início ao fim** da montagem



### PROFISSIONAIS QUALIFICADOS

Especialistas certificados na **MadeiraMadeira Serviços**.



### FERRAMENTAS PROFISSIONAIS

que **protegem** seus móveis.



### AGENDAMENTO EM 24 HORAS

escolha a data e o turno **ideais para** você.



### GARANTIA DE 3 MESES

de cobertura **completa**.

**Mais de 1 MILHÃO DE MONTAGENS**  
★ com avaliação 4.7 ★

#### Mariana S., São Paulo

"Chegaram no horário e montaram tudo rapidamente. Serviço incrível!"



#### Carlos R., Belo Horizonte

"Tentei montar sozinho e foi um desastre. Com a **MadeiraMadeira Serviços** ficou perfeito."



#### Ana P., Rio de Janeiro

"Agendamento ágil e **montagem pontual e perfeita**. Recomendo demais!"



## Agende agora pelo QR Code

Madeira**Madeira** Serviços · Atendimento em todo o Brasil



Escaneie o QRCode