

nesher



A marca da gestão florestal responsável

The mark of responsible forest management

La marca de la gestión forestal responsable

FSC • C168299

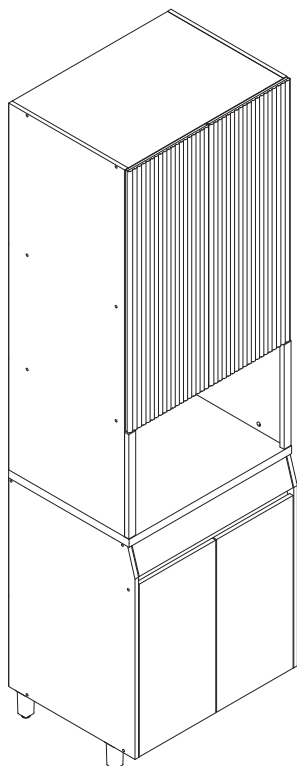

PANELEIRO 4 PORTAS 1 GAVETAS NESHER SIMONE MENDES 70 CM 100% MDF

NESHER SIMONE MENDES UPRIGHT CUPBOARD W/ 4 DOORS & 1 DRAWERS 70 CM 100% MDF
CACEROLERO DE 4 PUERTAS 1 CAJONES NESHER SIMONE MENDES DE 70 CM 100 % MDF

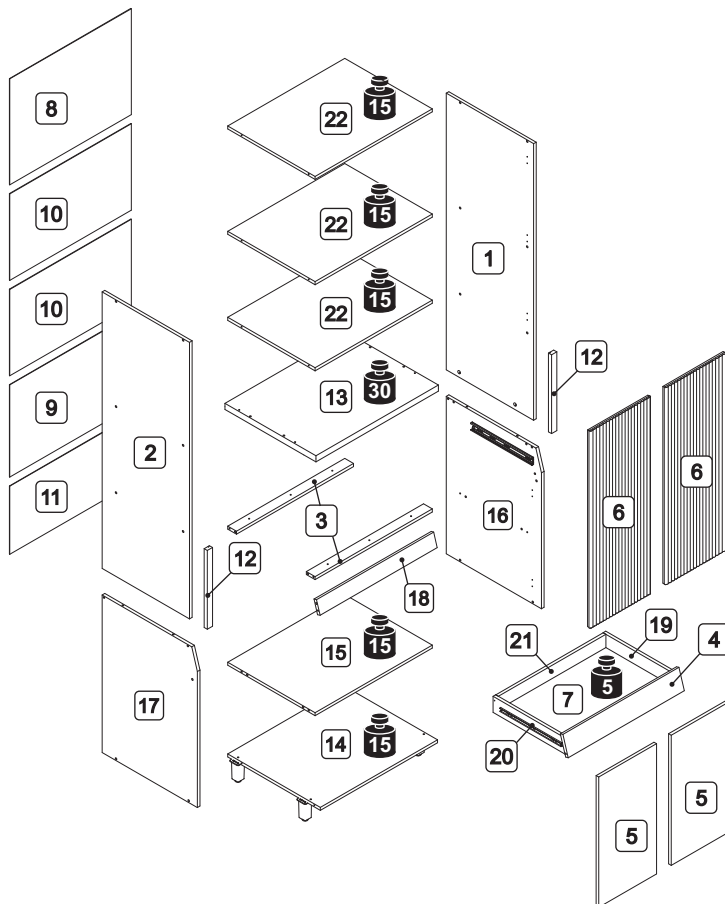

Peso máximo suportado
Maximum weight supported
Peso máximo suportado

DIMENSÕES MÁXIMAS DO PRODUTO MONTADO

MAXIMUM DIMENSIONS OF THE ASSEMBLED PRODUCT

DIMENSIONES MÁXIMAS DEL PRODUCTO MONTADO

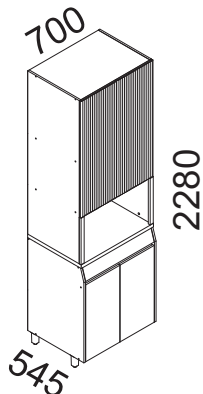

ESPAÇO INTERNO DAS GAVETAS (largura x altura x profundidade)

INTERNAL SPACE OF DRAWERS (width x height x depth)

ESPACIO INTERNO DE LOS CAJONES (ancho x alto x profundidad)

Ⓐ 615 x 66 x 385







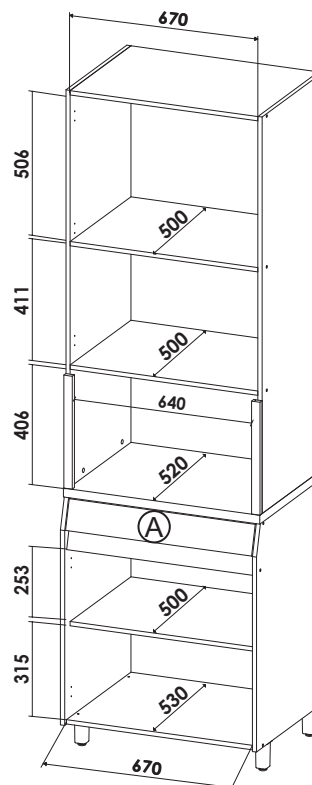

DIMENSÕES DOS ESPAÇOS INTERNOS (MEDIDAS EM MILÍMETROS)

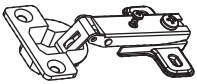

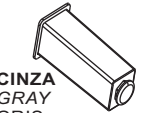
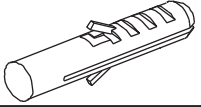
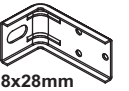
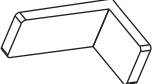
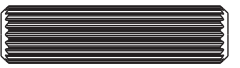
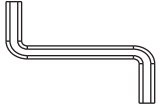

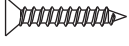
DIMENSIONS OF INTERNAL SPACES (MEASUREMENTS IN MILLIMETERS)

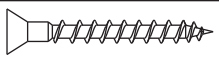
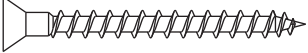
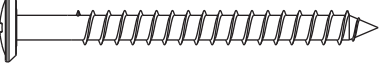
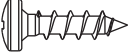
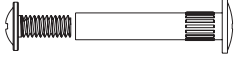
DIMENSIONES DEL ESPACIO INTERNO (MEDIDAS EN MILÍMETROS)

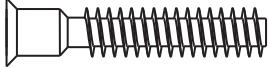

CÓDIGO CODE CÓDIGO	CARVALHO/GREIGE CARVALHO/GREGE CARVALHO/GREIGE	DESCRIÇÃO DESCRIPTION DESCRIPCIÓN	MAT. PRIMA RAW MATERIAL MATERIA PRIMA	QUANT. QTY CANT	MEDIDAS MEASUREMENTS MEDICIONES		
1	403525	LATERAL DIREITA SUPERIOR / UPPER RIGHT SIDE / LATERAL DERECHO SUPERIOR	MDF	1	1,370	500	15
2	403526	LATERAL ESQUERDA SUPERIOR / UPPER LEFT SIDE / LATERAL IZQUIERDO SUPERIOR	MDF	1	1,370	500	15
3	403493	TRAVESSA SUPERIOR / UPPER CROSSPIECE / LARGUERO SUPERIOR	MDF	2	670	50	15
4	403532	FRENTE DE GAVETA / DRAWER FRONT / FRENTE DEL CAJÓN	MDF	1	664	105	15
5	403533	PORTA / DOOR / PUERTA	MDF	2	645	330	15
6	403534	PORTA SUPERIOR / UPPER DOOR / PUERTA SUPERIOR	MDF	2	976	347	18
7	403457	FUNDO GAVETA / DRAWER BOTTOM / FONDO DEL CAJÓN	DURATREE	1	628	418	2,5
8	403458	FUNDO TRASEIRO / BACK PANEL / FONDO POSTERIOR	DURATREE	1	695	525	2,5
9	403459	FUNDO TRASEIRO / BACK PANEL / FONDO POSTERIOR	DURATREE	1	695	457	2,5
10	403460	FUNDO TRASEIRO / BACK PANEL / FONDO POSTERIOR	DURATREE	2	695	428	2,5
11	403461	FUNDO TRASEIRO / BACK PANEL / FONDO POSTERIOR	DURATREE	1	695	337	2,5
12	403478	MOLDURA LATERAL / SIDE MOLDING / MARCO LATERAL	MDF	2	390	30	18
13	403441	BANCADA / COUNTERTOP / ENCIMERA	MDF	1	701	520	30
14	403530	BASE / BASE / BASE	MDF	1	670	530	15
15	403491	PRATELEIRA INFERIOR / LOWER SHELF / ESTANTE INFERIOR	MDF	1	670	500	15
16	403523	LATERAL DIREITA / TOP RIGHT SIDE / LATERAL DERECHO	MDF	1	780	545	15
17	403524	LATERAL ESQUERDA / LEFT SIDE / LATERAL IZQUIERDO	MDF	1	780	545	15
18	403492	TRAVESSA FRONTAL / FRONT CROSSPIECE / LARGUERO DELANTERO	MDF	1	670	70	15
19	403528	LATERAL DE GAV DIR MENOR / RIGHT SIDE OF DRAWER SMALLER / CAJÓN LATERAL DERECHO	MDF	1	425	80	15
20	403529	LATERAL DE GAV ESQ MENOR / LEFT SIDE OF DRAWER SMALLER / CAJÓN LATERAL IZQUIERDO	MDF	1	425	80	15
21	403531	TRASEIRO DE GAVETA / DRAWER BACK / PARTE POSTERIOR DEL CAJÓN	MDF	1	615	80	15
22	403491	PRATELEIRA-TAMPO / SHELF-TOP / ESTANTE-TAPA	MDF	3	670	500	15

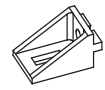
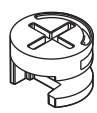
CÓDIGO/DESCRIÇÃO CODE/DESCRIPTION CÓDIGO/DESCRIPCIÓN	QUANTIDADE QUANTITY CANTIDAD	CÓDIGO/DESCRIÇÃO CODE/DESCRIPTION CÓDIGO/DESCRIPCIÓN	QUANTIDADE QUANTITY CANTIDAD
A7 DOBRADIÇA CURVA SLOW MOTION COM CALÇO ALTA CANECO 35mm - CÓDIGO 200163 35 mm SLOW-MOTION CURVE HINGE WITH STRAIGHT OVERLAY HINGE - CODE 200163 BISAGRA DE CIERRE CURVA LENTO CON CAZOLETA DE BISAGRA ALTA DE 35 mm - CÓDIGO 200163	 4	A8 DOBRADIÇA RETA SLOW MOTION COM CALÇO BAIXA CANECO 35mm - CÓDIGO 200162 35 mm SLOW-MOTION STRAIGHT OVERLAY HINGE WITH BASE PLATE - CODE 200162 BISAGRA DE CIERRE DERECHO LENTO BAJA CAZOLETA DE 35 mm CON CUÑA - CÓDIGO 200162	 6
A14 PAR CORREDIÇA TELESCÓPICA H32 350x30mm - CÓDIGO 200027 PAIR OF 350x30mm H32 TELESCOPIC DRAWER - CODE 200027 CORREDERA TELESCÓPICA PAR H32 DE 350x30mm - CÓDIGO 200027	 1	A16 PÉS DE PLÁSTICO 100x50x50mm - CÓDIGO 202367 100x50x50mm PLASTIC FEET - CODE 202367 PIES DE PLÁSTICO 100x50x50mm - CÓDIGO 202367	 4 CINZA GRAY GRIS
F2 BUCHA DE PAREDE PLÁSTICA DE 8mm 8mm PLASTIC WALL ANCHOR TACOS DE PARED PLASTIC DE 8mm	 6	F5 CANTONEIRA METÁLICA PARA FIXAÇÃO NA PAREDE 54x28x28mm 54x28x28mm METAL CORNER BRACE FOR SECURING TO WALL CANTONERA METÁLICA PARA FIJACIÓN EN LA PARED 54x28x28mm	 6
F6 CAPA PLÁSTICA PARA CANTONEIRA 55X30X30mm 55X30X30mm PLASTIC COVER FOR CORNER BRACE TAPA DE PLÁSTICO PARA ÂNGULO 55X30X30mm	 6 NATURE NATURE NATURE	F7 CAVILHA DE MADEIRA 8X30mm 8X30mm WOODEN DOWEL PIN TARUGO DE MADEIRA DE 8X30mm	 22
F9 CHAVE ZETA 4mm 4mm S-SHAPED HEX KEY LLAVE ZETA 4mm	 1	F10 DISPOSITIVO FIXADOR DE FUNDO DE PLÁSTICO 15x14x12mm 15x14x12mm PLASTIC DRAWER EDGE FASTENING DEVICE DISPOSITIVO SUJETADOR DEL FONDO DE PLÁSTICO 15x14x12mm	 4
F11 FIXADOR TRASEIRO METÁLICO 14x14mm 14x14mm METAL BACK PANEL FASTENER SUJETADOR METÁLICO DEL FONDO POSTERIOR 14x14mm	 25	F14 PARAFUSO PHILIPS 3,5x16mm CABEÇA CHATA PHILIPS SCREW 3,5x16 mm FLAT HEAD TORNILLO PHILIPS 3,5x16 mm CABEZA PLANA	 4
F15 PARAFUSO PHILIPS 3,5x14mm CABEÇA CHATA PHILIPS SCREW 3,5x14 mm FLAT HEAD TORNILLO PHILIPS 3,5x14 mm CABEZA PLANA	 12	F18 PARAFUSO PHILIPS 3,5x30mm CABEÇA CHATA PHILIPS SCREW 3,5x30 mm FLAT HEAD TORNILLO PHILIPS 3,5x30 mm CABEZA PLANA	 6
F19 PARAFUSO PHILIPS 3,5x40mm CABEÇA CHATA PHILIPS SCREW 3,5x40 mm FLAT HEAD TORNILLO PHILIPS 3,5x40 mm CABEZA PLANA	 2	F22 PARAFUSO PHILIPS 5x50mm CABEÇA FLANGEADA PHILIPS SCREW 5x50 mm FLANG HEAD TORNILLO PHILIPS 5x50 mm CABEZA CON BRIDA	 10
F23 PARAFUSO PHILIPS 4x14mm CABEÇA PANELA PHILIPS SCREW 4x14 mm PAN HEAD TORNILLO PHILIPS 4x14 mm CABEZA ALOMADA	 58	F25 PARAFUSO UNIÃO 28mm 28mm CONNECTOR SCREW TORNILLO DE UNIÃO 28mm	 4
F26 PARAFUSO UNIÃO 17mm 17mm CONNECTOR SCREW TORNILLO DE UNIÃO 17mm	 13	F27 PARAFUSO MINIFIX 6x30mm 6x30mm CAM LOCK SCREW TORNILLO MINIFIX 6x30mm	 11

<p>F28</p>  <p>22</p> <p>PARAFUSO ALLEN S. PONTA 7x40mm CABEÇA CHATA ALLEN SCREW WITOUH TIP 7x40 mm FLAT HEAD TORNILLO ALLEN SIN PUNTA 7x40 mm CABEZA PLANA</p>	<p>F29</p>  <p>80</p> <p>PREGO 10X10 COM CABEÇA 10x10 NAIL WITH HEAD CLAVO CON CABEZA DE 10x10</p>
<p>F31</p>  <p>6</p> <p>SUPORTE ANGULAR PLÁSTICA 22x15x12mm 22x15x12mm PLASTIC ANGLE BRACKET ESCUADRA DE ANGULO PLASTIC 22x15x12mm</p> <p>NATURE NATURE NATURE</p>	<p>F32</p>  <p>11</p> <p>TAMBOR MINIFIX 15mm 15mm CAM LOCK NUT TAMBOR MINIFIX 15mm</p>
<p>F33</p>  <p>10</p> <p>TAMPA DE PLÁSTICO MINIFIX 15mm 15mm PLASTIC CAM LOCK COVER CUBIERTA DE PLÁSTICO MINIFIX 15mm</p> <p>NATURE NATURE NATURE</p>	<p>F34</p>  <p>34</p> <p>TAPA FURO ADESIVO 12mm 12mm ADHESIVE HOLE COVERS CUBRE ORIFICIOS ADHESIVO DE 12mm</p> <p>NATURE NATURE NATURE</p>

Ferramentas para montagem e instalação / Tools for assembly and installation / Herramientas de montaje e instalación
Não fornecidas / Not Provided / No Provisto



PARAFUSADEIRA
POWER SCREWDRIVER
DESTORNILLADOR



FURADEIRA
DRILL
TALADRO



NÍVEL
LEVEL
NIVEL



TRENA
TAPE MEASURE
CINTA METRICA



MARTELO
HAMMER
MARTILLO



CHAVE PHILIPS E FENDA
PHILLIPS SCREWDRIVER
LLAVE PHILIPS



MONTAGEM
ASSEMBLY
MONTAJE

PASSO 1

STEP 1

PASO 1

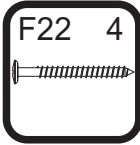
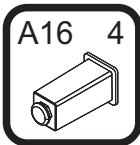

1 - Alinhar os pés A16 com os furos da base 14 e fixá-los com os parafusos F22 (5x50mm)

1 - Align feet A16 with the holes in base 14 and secure them with screws F22 (5x50 mm)

1 - Alinee los pies A16 con los orificios de la base 14 y fijelos con los tornillos F22 (5x50 mm)

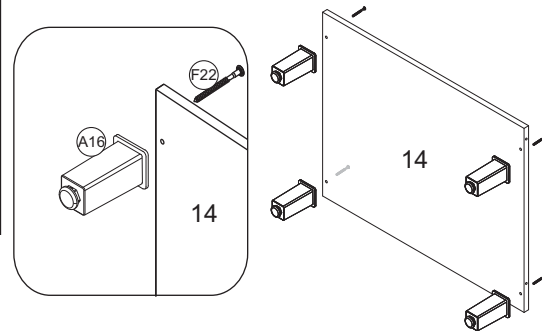

PASSO 3

STEP 3

PASO 3

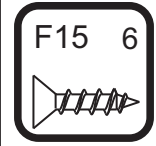
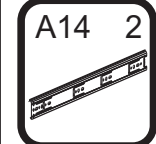
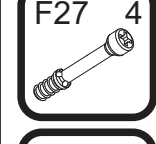
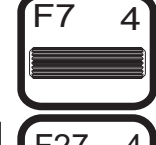
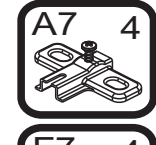
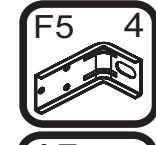

- 1 - Posicione as cantoneiras F5 na borda traseira das peças 16 e 17 e fixe-as com os parafusos F23 (4x14mm)
- 2 - Insira as cavilhas F7 (8x30mm) no topo das peças 16 e 17
- 3 - Fixe as corredeiras A14 nas marcações das laterais 16 e 17 utilizando o parafuso F15 (3,5x14mm)
- 4 - Com o parafuso F23 (4x14mm), fixe o calço da dobradiça A7 nas marcações frontais das peças 16 e 17
- 5 - Insira os minifix F27 nas peças 16 e 17

- 1 - Position corner braces F5 on the back edge of parts 16 and 17 and secure them with screws F23 (4x14 mm)
- 2 - Insert dowel pins F7 (8x30 mm) into to parts 16 and 17
- 3 - Secure drawer slides A14 to the markings on the sides 16 and 17 using screw F15 (3.5x14 mm)
- 4 - Using screw F23 (4x14mm), secure hinge base plate A7 the front markings on parts 16 and 17
- 1 - Insert overlay hinge F27 into parts 16 and 17

- 1 - Coloque las cantoneras F5 en el borde posterior de las piezas 16 y 17 y fijelas con los tornillos F23 (4x14 mm)
- 2 - Inserte los tarugos F7 (8x30 mm) en las piezas 16 y 17
- 3 - Fije las guías A14 las marcas de los separadores 20 con el tornillo F15 (3,5 x 14 mm)
- 4 - Utilizando el tornillo F23 (4x14 mm), fije la cuña de la bisagra A7 las marcas frontales de la pieza 16 y 17
- 5 - Inserte el minifix F27 en la piezas 16 y 17

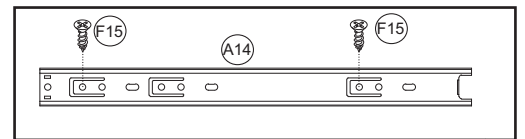

PASSO 2

STEP 2

PASO 2

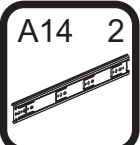

- 1 - Para montagem das corredeiras nas gavetas é necessário primeiramente separar o conjunto
- 2 - Levante a trava indicada no desenho abaixo e puxe a peça até separá-las totalmente

- 1 - To assemble the slides (runners) on the drawers, you must first separate the assembly
- 2 - Lift the lock indicated in the drawing below and pull the piece until it is completely separated

- 1 - Para montar las guías en los cajones, primero debe separar el conjunto
- 2 - Levante el pestillo que se muestra en el dibujo inferior y tire de la pieza hasta separarla por completo

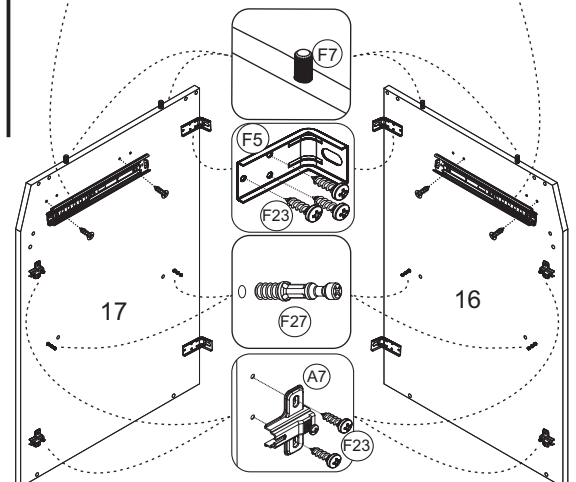
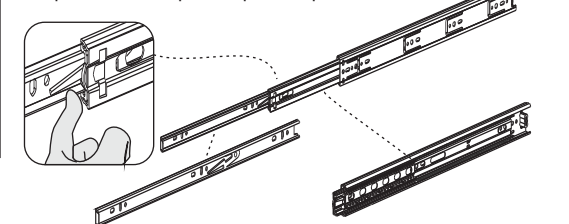

PASSO 4

STEP 4

PASO 4

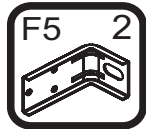

- 1 - Posicione as cantoneiras F5 na borda traseira das peças 1 e 2 e fixe-as com os parafusos F23 (4x14mm)
- 2 - Com o parafuso F23 (4x14mm), fixe o calço da dobradiça A8 nas marcações frontais das peças 1 e 2
- 3 - Inserir as cavilhas F7 (8x30mm) no topo das peças 1 e 2

- 1 - Position corner braces F5 on the back edge of parts 1 and 2 and secure them with screws F23 (4x14 mm)
- 2 - Using screw F23 (4x14mm), secure hinge base plate A8 the front markings on parts 1 and 2
- 3 - Insert dowel pins F7 (8x30 mm) into to parts 1 and 2

- 1 - Coloque las cantoneras F5 en el borde posterior de las piezas 1 y 2 y fijelas con los tornillos F23 (4x14 mm)
- 2 - Utilizando el tornillo F23 (4x14 mm), fije la cuña de la bisagra A8 las marcas frontales de la pieza 1 y 2
- 3 - Inserte los tarugos F7 (8x30 mm) en las piezas 1 y 2

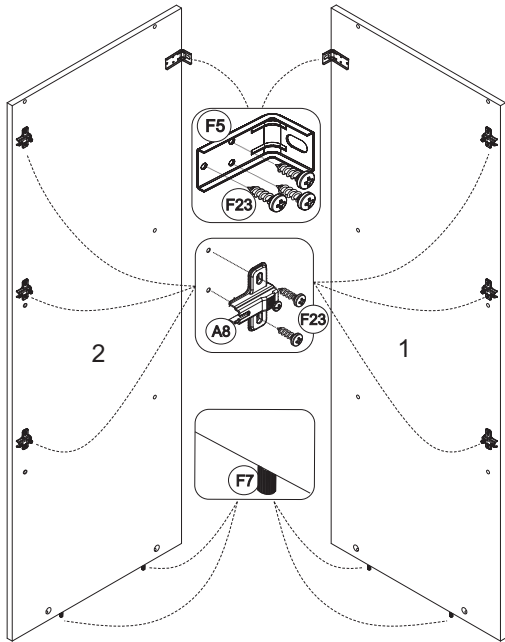

PASSO 6

STEP 6

PASO 6

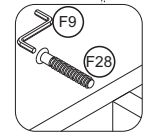
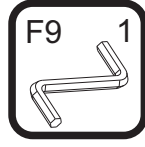

- 1 - Fixar a peça 14 nas laterais 16 e 17 com parafusos F28 (7x40mm), utilizando a chave zeta F9
- 2 - Encaixar a peça 15 e utilizando uma chave philips gire até travar

- 1 - Secure part 14 to sides 16 and 17 with screws F28 (7x40 mm), using S-shaped hex key F9
- 2 - Fit part 15, use a Philips screwdriver and turn it until it locks into place.

- 1 - Fije las pieza 14 a los laterales 16 y 17 con los tornillos F28 (7x40 mm), utilizando la llave zeta F9
- 2 - Encaje el pieza 15 y utilizando un destornillador philips para girar hasta que encaje

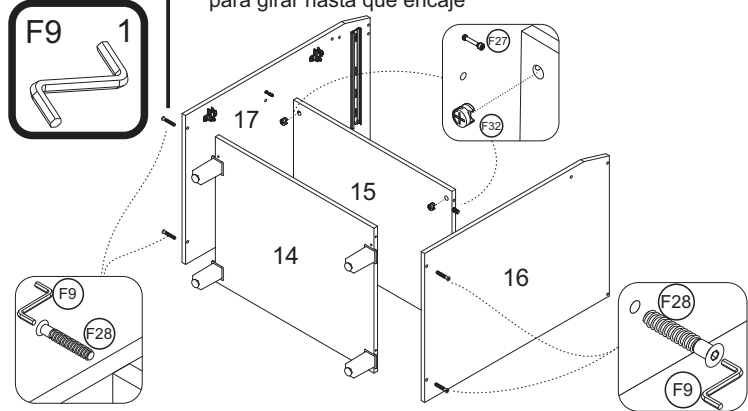

PASSO 7

STEP 7

PASO 7

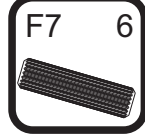
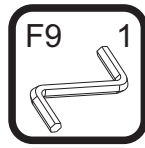

- 1 - Inserir as cavilhas F7 (8x30mm) nas travessas sup. 3 e na travessa frontal 18
- 2 - Fixar as travessas superiores 3 e a travessa frontal 18 na laterais 16 e 17 com o parafuso F28 (7x40mm), utilizando a chave zeta F9

- 1 - Insert the dowels F7 (8x30mm) into the upper crosspieces 3 and the front crosspiece 18
- 2 - Secure the crosspieces 3 end 18 on the sides 16 end 17 with screw F28 (7x40 mm), using S-shaped hex key F9

- 1 - Inserte los tarugos F7 (8x30mm) en el larguero 3 y el larguero frontal 18
- 2 - Fije los largueros 3 y el largueros frontal 18 a los laterales 16 y 17 con el tornillo F28 (7x40 mm), utilizando la llave zeta F9

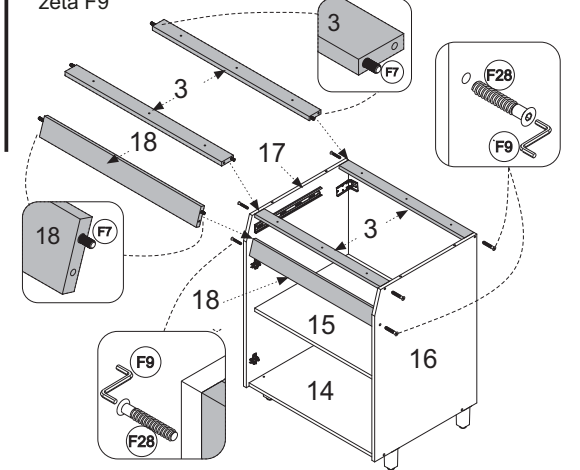

PASSO 5

STEP 5

PASO 5



- 1 - Inserir as cavilhas F7 (8x30mm) no topo da peça 15
- 2 - Encaixar o tambor do minifix F32 da peça 15

- 1 - Insert dowel pins F7 (8x30 mm) into to part 15
- 2 - Insert cam lock nut F32 the parts 15

- 1 - Inserte los tarugos F7 (8x30mm) en el pieza 15
- 3 - Inserte el tambor del minifix F32 en los pieza 15

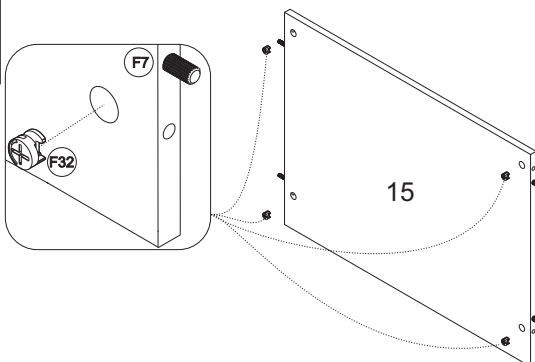

PASSO 8

STEP 8

PASO 8

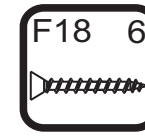

- 1 - Encaixar a bancada 13 nas laterais 16 e 17
- 2 - Fixar a bancada 13 nas travessas 3 com os parafusos F18 (3,5x30mm)

- 1 - Fit countertop 13 to sides 16 and 17
- 2 - Secure countertop 13 to the crosspieces 3 with screws F18 (3.5x30 mm)

- 1 - Encaje la encimera 13 a los laterales 16 y 17
- 2 - Fije la encimera 13 a los largueros 3 con tornillos F18 (3,5x30 mm)

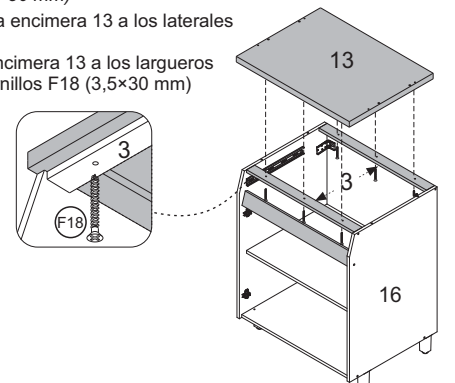

PASSO 9

STEP 9

PASO 9

F28 12



F9 1



1 - Fixar as laterais 1 e 2 nas peças 22 com os parafusos F28 (7x40mm), utilizando a chave zeta F9

1 - Secure side 1 and 2 to parts 22, with screws F28 (7x40 mm), using S-shaped hex key F9

1 - Fije el lateral 1 y 2 a las partes 22, con tornillos F28 (7 x 40 mm), utilizando la llave zeta F9

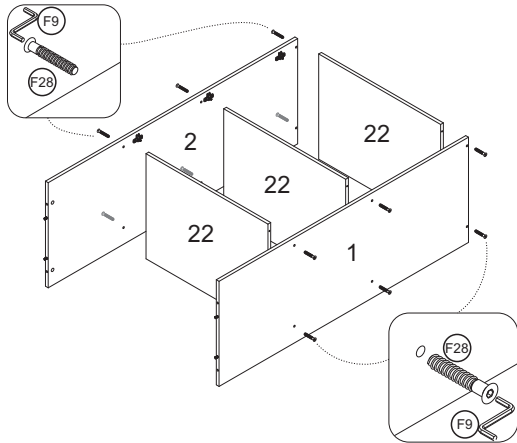

PASSO 10

STEP 10

PASO 10

F27 4



F32 4



1 - Inserir o minifix F27 na peça 13 do conjunto montado inferior

2 - Encaixar o conjunto montado superior no conjunto inferior

3 - Inserir o tambor do minifix F32 nas laterais 1 e 2 e utilizar uma chave philips para girar o tambor até travar na haste do parafuso

1 - Insert overlay hinge F27 into part 13 of the lower assembled set

2 - Fit the upper assembled set into the lower assembled set

3 - Insert cam lock nut F32 into sides 1 and 2 and use a Philips screwdriver to turn the nut until it locks onto the cam lock screw

1 - Inserte el minifix F27 en la pieza 13 del conjunto montado inferior

2 - Encaje el conjunto montado superior en el conjunto inferior

3 - Inserte el tambor del minifix F32 en los laterales 1 y 2 y utilice un destornillador philips para girar el tambor hasta que encaje en el vástago del tornillo

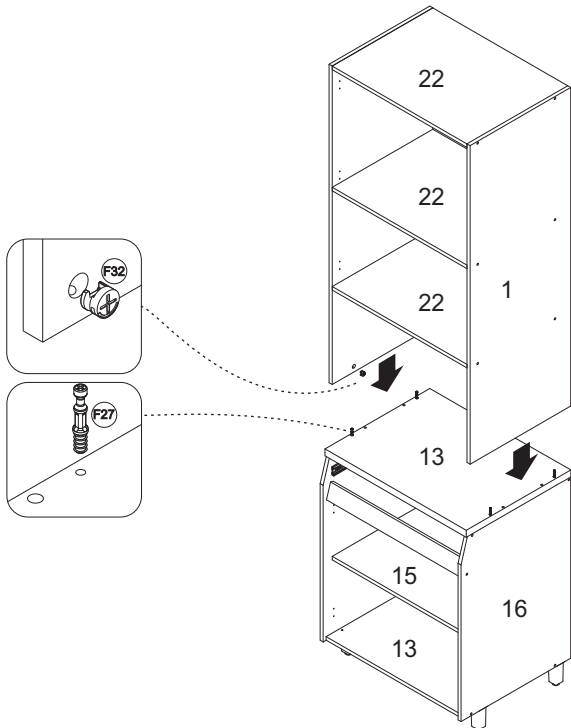

PASSO 11

STEP 11

PASO 11

F29 80



F11 25



1 - Alinhar a peça 8 e fixá-la com pregos F29 (10x10) na parte de cima e nas laterais, e alinhar as demais peças 10, e fixá-las com os pregos F29 (10x10) nas laterais

2 - Alinhar a peça 11 e fixá-la com pregos F29 (10x10) na base e nas laterais, e alinhar a peça 9 fixá-la nas laterais

4 - Na junção entre as peças 8, 9, e 10 utilizar os pregos F29 (10x10) com o fixador metálico F11

1 - Align part 8 and secure it with nails F29 (10x10) on the top and sides, and align the other parts 10 and secure them with nails F29 (10x10) on the sides

2 - Align part 11 and secure it with nails F29 (10x10) on the base and sides, and align the part 9 and secure it on the sides

4 - At the junction between parts 8, 9 and 10, use nails F29 (10x10) with metal fastener F11

1 - Alinee la pieza 8 y fijela con clavos F29 (10x10) en la parte superior y en los laterales, y alinee las otras piezas 10 y fijelas con clavos F29 (10x10) en los laterales

2 - Alinee la pieza 11 y fijela con clavos F29 (10x10) a la base y a los laterales, y alinee la pieza 9 y fijela a los laterales

4 - Al unir las piezas 8, 9, Y 10, utilice clavos F29 (10x10) con el sujetador metálico F11

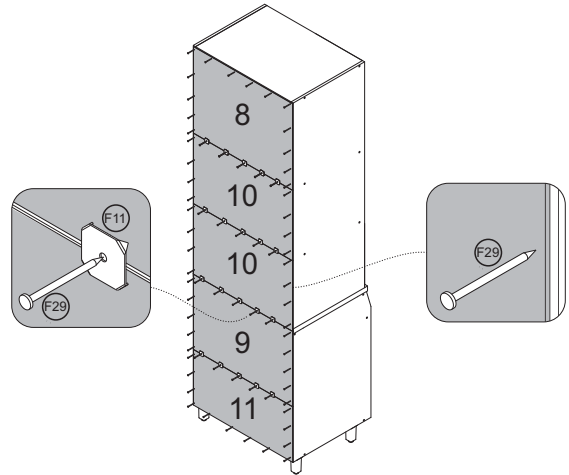

PASSO 12

STEP 12

PASO 12

F31 6

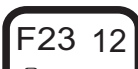

F23 12



1 - Colocar as molduras 12 na parte frontal do painel e fixá-las nas laterais 1 e 2 com os acessórios F31 e parafusos F23 (4x14mm)

1 - Place moldings 12 on the front of the panel and secure them on sides 1 and 2 with accessories F31 and screws F23 (4x14 mm)

1 - Coloque los marcos 12 en la parte delantera del cacerolero y fijelos a los laterales 1 y 2 con los herrajes F31 y los tornillos F23 (4x14 mm)

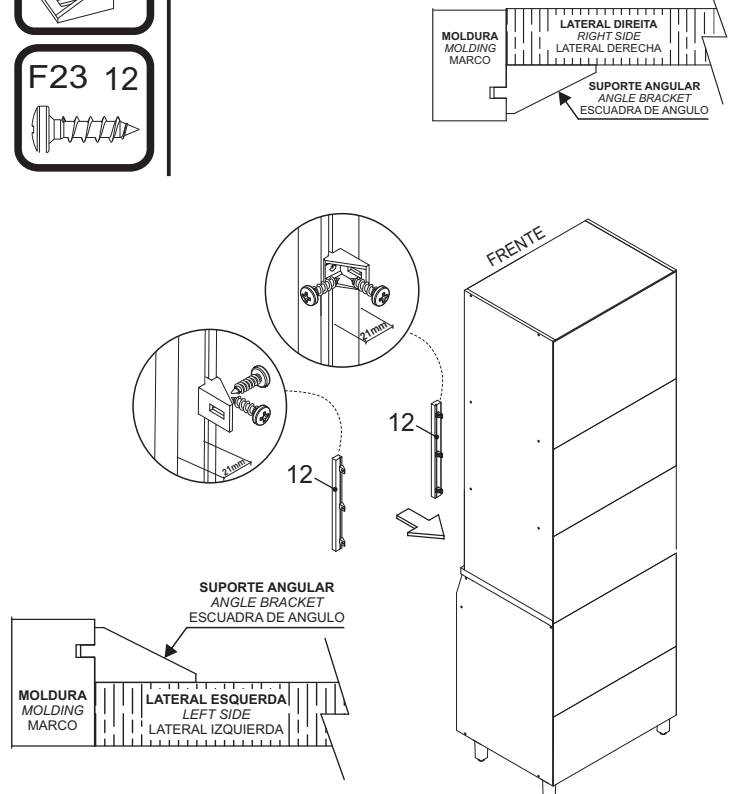

PASSO 13

STEP 13

PASO 13

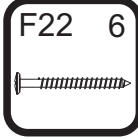
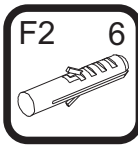

FIXAÇÃO NA PAREDE (ALVENARIA)

ATENÇÃO: Antes de fixar o armário na parede verifique se o local possui condições adequadas para suportar o produto.

- 1 - Posicione o armário na parede e alinhe-o utilizando um nível
- 2 - Fure a parede com a broca de 8mm através do furo da cantoneira
- 3 - Insira o conjunto de parafuso e bucha no furo e aperte até o final para travar

SECURING TO WALL (MASONRY)

ATTENTION: Before securing the cabinet to the wall, check whether the location has suitable conditions to support the product.

- 1 - Position the cabinet on the wall and align it using a level
- 2 - Drill wall with 8 mm bit through the hole in the corner brace
- 3 - Insert the screw and anchor assembly into the hole and tighten to the end in order to lock into place

FIJACIÓN EN LA PARED (MAMPOSTERÍA)

ATENCIÓN: Antes de fijar el mueble a la pared, compruebe que la ubicación es adecuada y puede soportar el peso del producto.

- 1 - Coloque el armario en la pared y alinéelo con un nivel
- 2 - Taladre la pared con la broca de 8 mm a través del orificio de la cantonera
- 3 - Inserte el conjunto de tornillo y taco en el orificio y apriétele hasta el

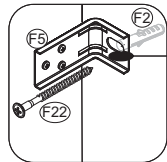

FURAR AQUI / DRILL HERE / PERFORAR

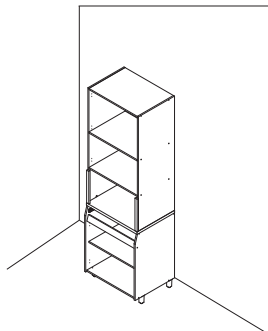

OBS: No final deste manual, verifique sugestões alternativas de instalação do produto em paredes que não sejam de alvenaria (gesso acartonado/drywall)

NOTE: At the end of this manual, see alternative suggestions for installing the product on non-masonry walls (plasterboard/drywall)

OBS: Al final de este manual, consulte las sugerencias alternativas para instalar el producto en paredes que no sean de mampostería (yeso acartonado/pared seca)

PASSO 14

STEP 14

PASO 14

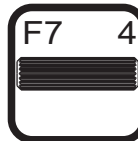
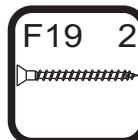

- 1 - Inserir as cavilhas F7 (8x30mm) nas peças 19, 20 e 21.
- 2 - Encaixar a peça 21 entre as laterais 19 e 20
- 3 - Fixar as peças 21 com os parafusos F19 (3,5x40mm)
- 4 - Encaixar o fundo 7 no conjunto

- 1 - Insert dowel pins F7 (8x30 mm) into parts 19, 20 and 21
- 2 - Fit part 21 between sides 19 and 20
- 3 - Secure the parts 21 with screws F19 (3.5x40 mm)
- 4 - Fit drawer bottom 7 into the assembly

- 1 - Inserte los tarugos F7 (8x30 mm) en las piezas 19, 20 y 21
- 2 - Encaje la pieza 21 entre los laterales 19 y 20
- 3 - Fije las piezas 21 con tornillos F19 (3,5x40 mm)
- 4 - Coloque la parte inferior 7 en el conjunto.

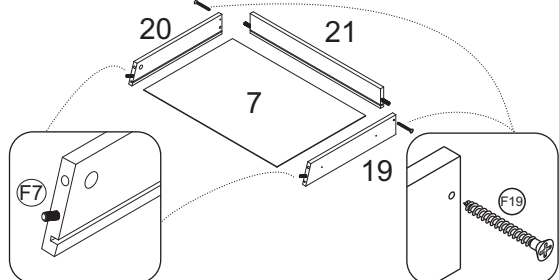

PASSO 15

STEP 15

PASO 15

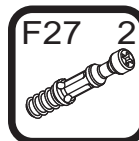

- 1 - Inserir os minifix F27 na peça 4
- 2 - Encaixar a peça 4 no conjunto montado no passo anterior
- 3 - Encaixar o tambor do minifix F32 nas laterais de gaveta e utilizando uma chave philips para girar até travar.

- 1 - Insert overlay hinge F27 into part 4
- 2 - Fit part 4 into the assembly completed in the previous step
- 3 - Fit cam lock nut F32 onto the drawer sides, use a Philips screwdriver and turn it until it locks into place.

- 1 - Inserte el minifix F27 en la pieza 4
- 2 - Encaje la pieza 4 en el conjunto montado en El paso anterior
- 3 - Encaje el tambor del minifix F32 en los laterales del cajón utilizando un destornillador philips para girar hasta que encaje

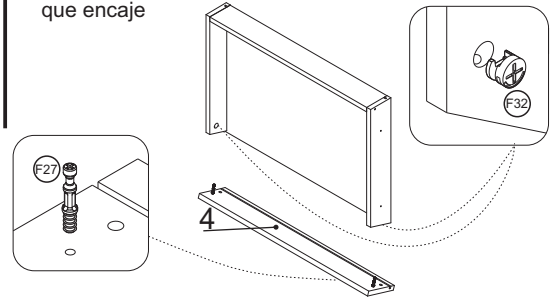

PASSO 16

STEP 16

PASO 16

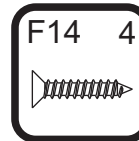
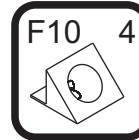
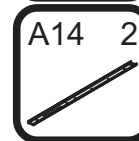
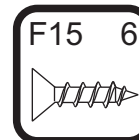

- 1 - Alinhar os furos da correia A14 (350x30mm) com as marcações da lateral e fixar com parafuso F15 (3,5x14mm)
- 2 - Encaixar o fixador de fundo F10 entre o rasgo e o fundo das gavetas e fixe-os com os parafusos F14 (3x16mm)

- 1 - Align the holes of the A14 slide (350x30mm) with the markings on the side and secure with an F15 screw (3.5x14mm)
- 2 - Fit drawer edge fastener F10 between the slot and the drawer bottoms and secure them with screws F14 (3x16 mm)

- 1 - Alinee las marcas de la guia A14 (350x30 mm) con las marcas en el lateral y fijela con el tornillo F15 (3,5x14mm)
- 2 - Coloque el sujetador de fondo F10 entre la ranura y el fondo de los cajones y fijelos con los tornillos F14 (3 x 16 mm)

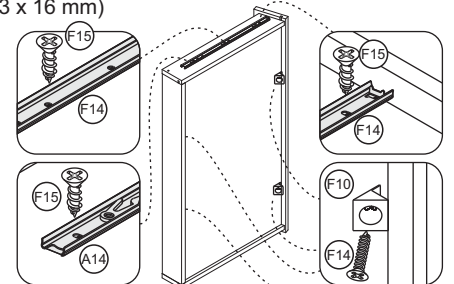

PASSO 17

STEP 17

PASO 17

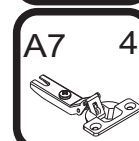
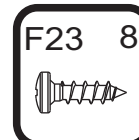

- 1 - Fixar as dobradiças A7 nas portas 5 com parafuso F23 (4x14mm)
- 2 - Repetir o processo para montagem da outra porta

- 1 - Secure hinges A7 on doors 5 with screw F23 (4x14 mm)
- 2 - Repeat the process to assemble the other door

- 1 - Fije las bisagras A7 a las puertas 5 con el tornillo F23 (4x14 mm)
- 2 - Repita el proceso para montar la otra puerta

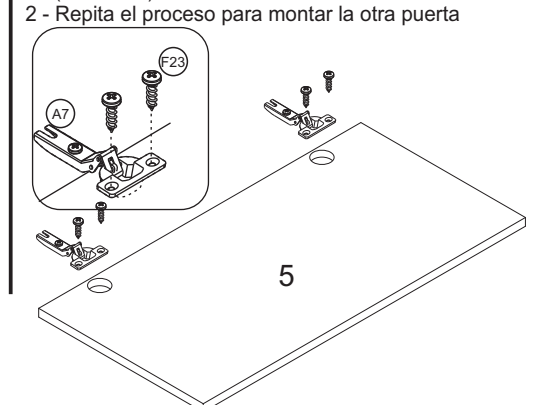

PASSO 18

STEP 18

PASO 18

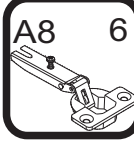

- 1 - Fixar as dobradiças A8 nas portas 6 com parafuso F23 (4x14mm)
- 2 - Repetir o processo para montagem da outra porta

- 1 - Secure hinges A8 on doors 6 with screw F23 (4x14 mm)
- 2 - Repeat the process to assemble the other door

- 1 - Fije las bisagras A8 a las puertas 6 con el tornillo F23 (4x14 mm)
- 2 - Repita el proceso para montar la otra puerta

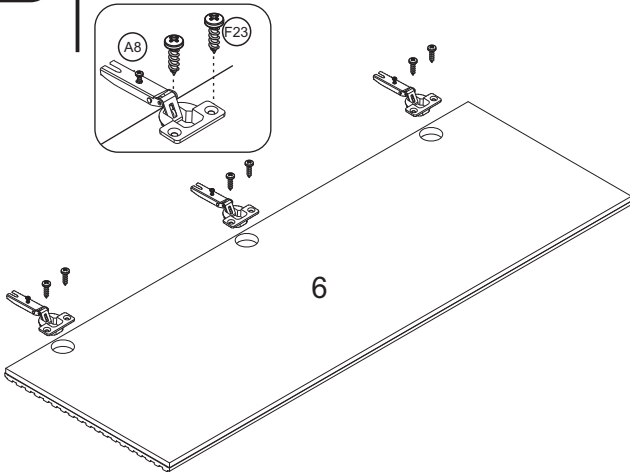

PASSO 20

STEP 20

PASO 20

- 1 - Encaixar a gaveta
- 2 - Verificar se os 2 lados estão bem encaixados

- 1 - Insert the drawer
- 2 - Check that the 2 sides fit properly

- 1 - Encaje lo cajone
- 2 - Compruebe que los 2 lados están bien encajados

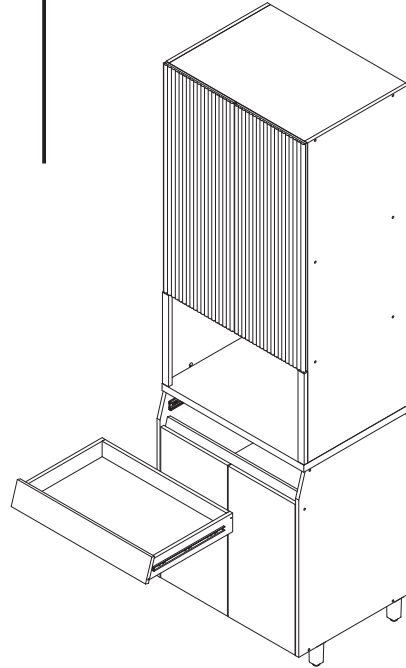

PASSO 19

STEP 19

PASO 19

- 1 - Para montar das porta, encaixe a dobradiça no calço travando-a no parafuso indicado com o número 1 abaixo:

- 1 - To assemble the door, fit hinge onto hinge base plate, locking it onto the screw indicated with # 1 below:

- 1 - Para montar la puerta, encaje la bisagra en la cuña, bloqueándola en el tornillo indicado con el número 1 a continuación:

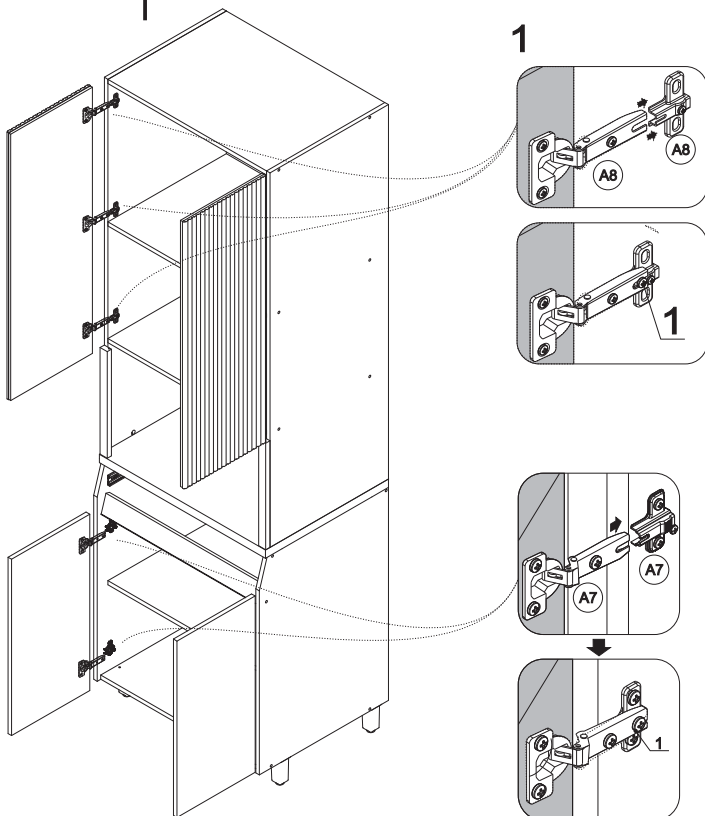

PASSO 21

STEP 21

PASO 21

Para regulagem das portas siga as instruções conforme números abaixo:

- 1 - Se precisar subir ou abaixar um pouco a porta desaperte um pouco os parafusos indicados com o número 1, reposicione e aperte novamente
- 2 - Se precisar empurrar a porta um pouco mais para dentro ou puxá-la para fora, desaperte um pouco o parafuso indicado com o nº 2, reposicione e aperte novamente
- 3 - Se precisar alinhar as portas um pouco mais para o centro ou em direção as laterais, utilize uma chave philips para girar o parafuso indicado com o nº 3 até posicionar a porta da forma desejada

To adjust the doors, follow the instructions according to the numbers below:

- 1 - If you need to raise or lower the door a little, loosen the screws indicated with # 1, reposition and tighten again
- 2 - If you need to push the door a little further in or pull it out, loosen the screw indicated by # 2 a little, reposition it and tighten it again
- 3 - If you need to align the doors a little more towards the center or towards the sides, use a Philips screwdriver to turn the screw indicated by # 3 until you position the door as desired.

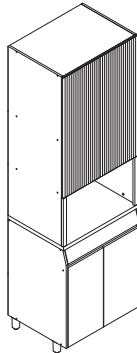

Para ajustar las puertas, siga las instrucciones de las figuras siguientes:

- 1 - Si necesita subir o bajar un poco la puerta, afloje los tornillos indicados con el número 1, vuelva a colocarlos y apriételes de nuevo
- 2 - Si necesita empujar la puerta un poco más hacia dentro o afuera, afloje un poco el tornillo indicado con el número 2, vuelva a colocarlo y apriétele de nuevo
- 3 - Si necesita alinear las puertas un poco más hacia el centro o hacia los lados, utilice un destornillador philips para girar el tornillo indicado con el número 3 hasta que la puerta quede colocada de la forma deseada

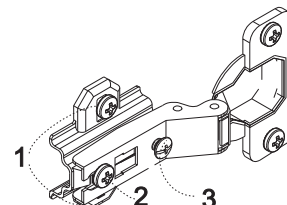

PASSO 22

STEP 22

PASO 22

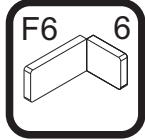
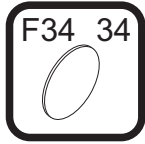

Para fazer o acabamento dos módulos siga os passos abaixo:

- 1 - Cole o tapa furo adesivo F34 (12mm) sobre todos os parafusos aparentes
- 2 - Encaixe a tampa plástica F6 sobre todas as cantoneiras metálicas
- 3 - Encaixe as tampas F33 sobre os tambores dos minifix das gavetas

To finish the modules, follow the steps below:

- 1 - Stick adhesive hole covers F34 (12 mm) over all visible screws
- 2 - Fit plastic cover F6 over all metal corner braces
- 3 - Place the covers F33 over the cam lock nuts in the drawers

Para terminar el armado de los módulos, siga los pasos que se indican a continuación:

- 1 - Pegue el cubre orificio adhesivo F34 (12 mm) sobre todos los tornillos a la vista
- 2 - Coloque la cubierta de plástico F6 sobre todas las cantoneras metálicas
- 3 - Coloque las cubiertas F33 sobre los tambores de los minifix de los cajones

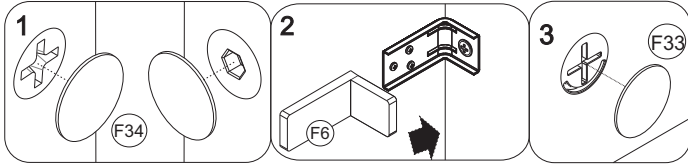

ATENÇÃO: Caro(a) cliente, na ferragem desse produto contém componentes para instalação do móvel em parede de alvenaria. Para fixação do armário em paredes de gesso acartonado/drywall, é necessário adquirir, em uma loja de material de construção, a ferragem específica para esses tipos de parede

ATTENTION: Dear customer, the hardware of this product contains components for installing the unit on a masonry wall. To secure the cabinet to plasterboard/drywall walls, it is necessary to purchase specific hardware for these types of walls at a hardware store.

ATENCIÓN: Estimado cliente, los herrajes de este producto contienen componentes para instalar el mueble en un muro de mampostería. Para fijar el armario a las paredes de yeso acartonado/pared seca, tendrá que comprar los herrajes específicos para este tipo de paredes en una tienda de materiales de construcción

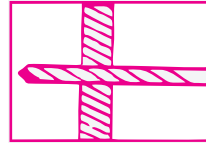

- 1 - Fure a parede de acordo com o diâmetro da bucha**
 1 - Drill the wall according to the diameter of the anchor
 1 - Taladre la pared en función del diámetro del taco

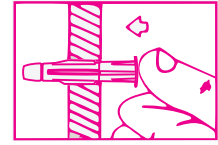

- 2 - Introduza a bucha no furo da parede**
 2 - Insert the anchor into the hole in the wall
 2 - Inserte el taco en el agujero de la pared

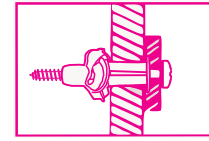

- 3 - Posicione o armário com a cantoneira sobre a bucha e fixe-o com um parafuso. Aperte o parafuso até a fixação estar segura**
 3 - Position the cabinet with the corner brace over the anchor and secure it with a screw. Tighten the screw until securely affixed
 3 - Coloque el armario con la cantonera sobre el taco y fijela con un tornillo. Apriete el tornillo hasta que la fijación quede firme

OPÇÃO 2 - FIXAÇÃO GESSO/DRYWALL - BUCHA MU
 OPTION 2 - SECURING ON PLASTERBOARD/DRYWALL - M.U. ANCHOR
 OPCIÓN 2 - FIJACIÓN EN YESO/PARED SECA - TACO MU

ATENÇÃO: Caro(a) cliente, na ferragem desse produto contém componentes para instalação do móvel em parede de alvenaria. Para fixação do armário em paredes de gesso acartonado/drywall, é necessário adquirir, em uma loja de material de construção, a ferragem específica para esses tipos de parede.

ATTENTION: Dear customer, the hardware of this product contains components for installing the unit on a masonry wall. To secure the cabinet to plasterboard/drywall walls, it is necessary to purchase specific hardware for these types of walls at a hardware store.

ATENCIÓN: Estimado cliente, los herrajes de este producto contienen componentes para instalar el mueble en un muro de mampostería. Para fijar el armario a las paredes de yeso acartonado/pared seca, tendrá que comprar los herrajes específicos para este tipo de paredes en una tienda de materiales de construcción

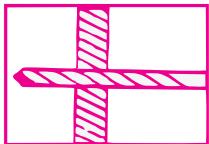

- 1 - Fure a parede de acordo com o diâmetro da bucha**
 1 - Drill the wall according to the anchor diameter
 1 - Taladre la pared en función

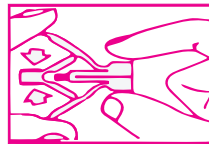

- 2 - Comprima as asas da bucha antes de introduzi-la**
 2 - Compress the wings of the anchor before inserting it
 2 - Comprima las alas del taco antes de insertarlo

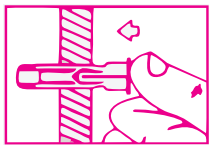

- 3 - Introduza a bucha no furo da parede**
 3 - Insert the anchor into the hole in the wall
 3 - Inserte el taco en el agujero de la pared

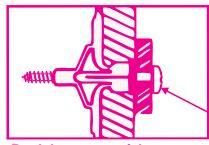

- 4 - Posicione o armário com a cantoneira sobre a bucha e fixe-o com um parafuso**
 4 - Position the cabinet with the corner brace over the anchor and secure it with a screw
 4 - Coloque el armario con la cantonera sobre el taco y fijela con un tornillo

Aperte o parafuso até a fixação estar segura
 Tighten the screw until securely affixed
 Apriete el tornillo hasta que la fijación quede firme

OPÇÃO 1 - FIXAÇÃO GESSO/DRYWALL - BUCHA FLY
 OPTION 1 - SECURING ON PLASTERBOARD/DRYWALL - WINGED ANCHOR
 OPCIÓN 1 - FIJACIÓN EN YESO/PARED SECA - TACO CON ALAS

neshher

ARMÁRIO AÉREO 2 PORTAS
NESHER SIMONE MENDES 120CM 100% MDF

NESHER SIMONE MENDES WALL CABINET W/ 2 DOORS 120 CM 100% MDF
 ARMARIO COLGANTE CON 2 PUERTA NESHER SIMONE MENDES DE 120 CM 100 % MDF



A marca da gestão florestal responsável
 The mark of responsible forest management
 La marca de la gestión forestal responsable
FSC • C168299

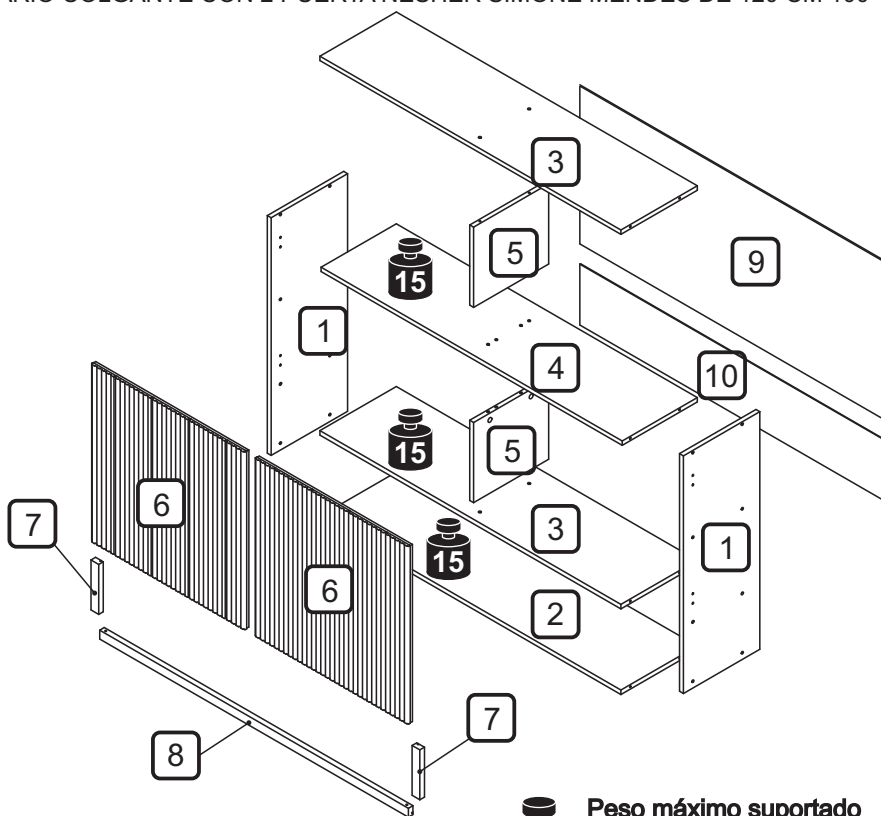
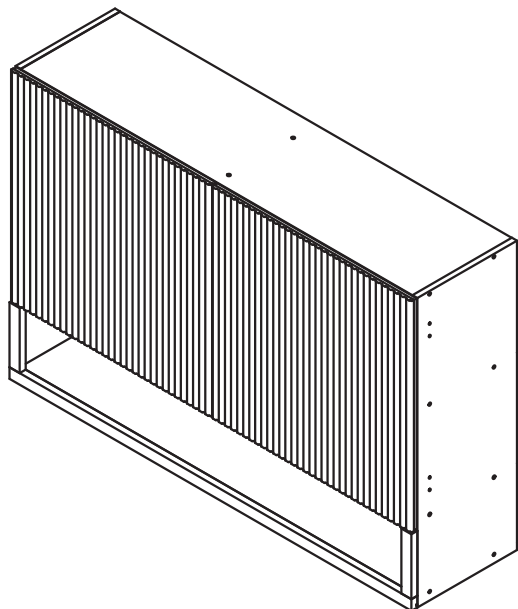

Peso máximo suportado
 Maximum weight supported
 Peso máximo suportado



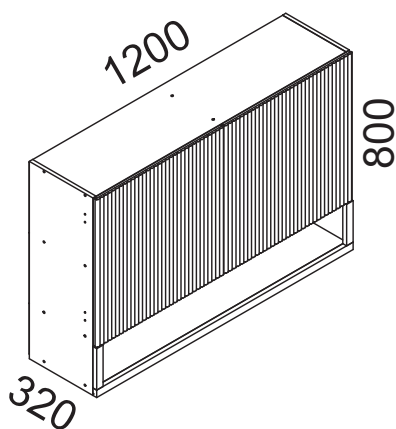



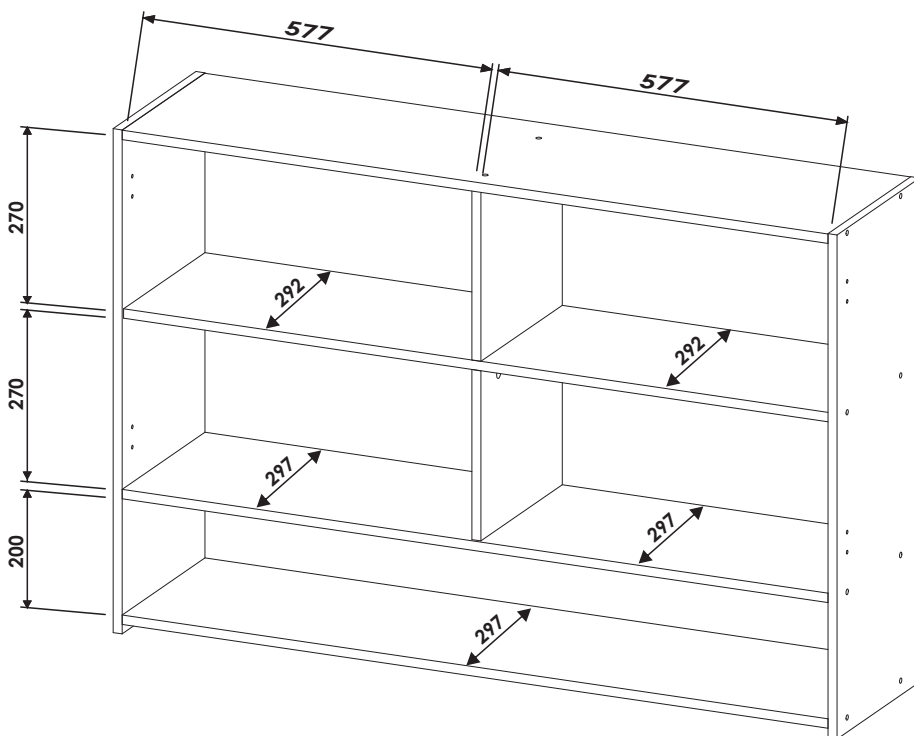

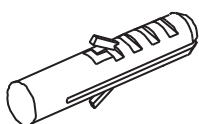
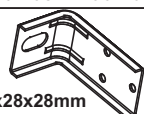
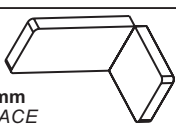

DIMENSÕES MÁXIMAS DO PRODUTO MONTADO
 MAXIMUM DIMENSIONS OF THE ASSEMBLED PRODUCT
 DIMENSIONES MÁXIMAS DEL PRODUCTO MONTADO

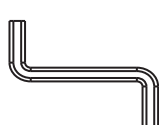

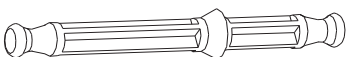
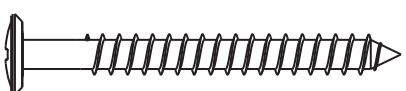
DIMENSÕES DOS ESPAÇOS INTERNOS (MEDIDAS EM MILÍMETROS)
 DIMENSIONS OF INTERNAL SPACES (MEASUREMENTS IN MILLIMETERS)
 DIMENSIONES DEL ESPACIO INTERNO (MEDIDAS EN MILÍMETROS)

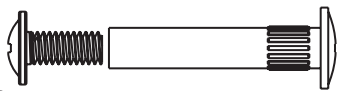
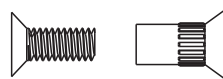
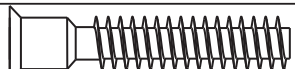
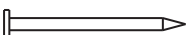

CÓDIGO CODE CÓDIGO	CARVALHO-GREIGE CARVALHO-GREIGE CARVALHO-GREIGE	DESCRIÇÃO DESCRIPTION DESCRIPCIÓN	MAT. PRIMA RAW MATERIAL MATERIA PRIMA	QUANT QTY CANT	COMP MEASUREMENTS MEDICIONES		
1	403562	LATERAL DIREITA/ESQUERDA / RIGHT_LEFT SIDE / LATERAL DERECHO_IZQUIERDO	MDF	2	800	297	15
2	403563	BASE / BASE / BASE	MDF	1	1,170	297	15
3	403564	TAMPO-PRATELEIRA INFERIOR / TOP-SHELF LOWER / TAPA-ESTANTE INFERIOR	MDF	2	1,170	297	15
4	403565	PRATELEIRA CENTRAL / CENTER SHELF / ESTANTE CENTRAL	MDF	1	1,170	292	15
5	403566	DIVISÃO / DIVIDER / DIVISIÓN	MDF	2	270	292	15
6	403535	PORTA / DOOR / PUERTA	MDF	2	598	598	18
7	403479	MOLDURA LATERAL / SIDE MOLDING / MARCO LATERAL	MDF	2	168	30	18
8	403480	MOLDURA INFERIOR / LOWER MOLDING / MARCO INFERIOR	MDF	1	1,200	30	18
9	403462	FUNDO TRASEIRO / BACK PANEL / FONDO POSTERIOR	DURATREE	1	1,195	575	2.5
10	403463	FUNDO TRASEIRO / BACK PANEL / FONDO POSTERIOR	DURATREE	1	1,195	205	2.5

CÓDIGO/DESCRIÇÃO CODE/DESCRIPTION CÓDIGO/DESCRIPCIÓN	QUANTIDADE QUANTITY CANTIDAD	CÓDIGO/DESCRIÇÃO CODE/DESCRIPTION CÓDIGO/DESCRIPCIÓN	QUANTIDADE QUANTITY CANTIDAD
A8  DOBRADIÇA RETA SLOW MOTION COM CALÇO BAIXA CANECO 35mm - CÓDIGO 200162 35 mm SLOW-MOTION STRAIGHT OVERLAY HINGE WITH BASE PLATE - CODE 200162 BISAGRA DE CIERRE DERECHO LENTO BAJA CAZOLETA DE 35 mm CON CUÑA - CÓDIGO 200162	4	F2  BUCHA DE PAREDE PLÁSTICA DE 8mm 8mm PLASTIC WALL ANCHOR TACOS DE PARED PLASTIC DE 8mm	4
F5  CANTONEIRA METÁLICA PARA FIXAÇÃO NA PAREDE 54x28x28mm 54x28x28mm METAL CORNER BRACE FOR SECURING TO WALL CANTONERA METÁLICA PARA FIJACIÓN EN LA PARED 54x28x28mm	4	F6  CAPA PLÁSTICA PARA CANTONEIRA 55x30x30mm 55x30x30mm PLASTIC COVER FOR CORNER BRACE TAPA DE PLÁSTICO PARA ÂNGULO 55x30x30mm	4 NATURE NATURE NATURE
F7  CAVILHA DE MADEIRA 8x30mm 8x30mm WOODEN DOWEL PIN TARUGO DE MADERA 8x30mm	4	F9  CHAVE ZETA 4mm 4mm S-SHAPED HEX KEY LLAVE ZETA 4mm	1
F11  FIXADOR TRASEIRO METÁLICO 14x14mm 14x14mm METAL BACK PANEL FASTENER SUJETADOR METÁLICO DEL FONDO POSTERIOR 14x14mm	12	F12  HASTE DUPLA PARA MINIFIX CAM LOCK DOUBLE SCREW VÁSTAGO DOBLE PARA MINIFIX	2
F22  PARAFUSO PHILIPS 5x50mm CABEÇA FLANGEADA PHILIPS SCREW 5x50 mm FLANG HEAD TORNILLO PHILIPS 5x50 mm CABEZA CON BRIDA	4	F23  PARAFUSO PHILIPS 4x14mm CABEÇA PANELA PHILIPS SCREW 4x14 mm PAN HEAD TORNILLO PHILIPS 4x14 mm CABEZA ALOMADA	36
F25  PARAFUSO UNIÃO 28mm 28mm CONNECTOR SCREW TORNILLO DE UNIÃO 28mm	3	F26  PARAFUSO UNIÃO 17mm 17mm CONNECTOR SCREW TORNILLO DE UNIÃO 17mm	9
F28  PARAFUSO ALLEN S_PONTA 7x40mm CABEÇA CHATA ALLEN SCREW WITOUH TIP 7x40 mm FLAT HEAD TORNILLO ALLEN SIN PUNTA 7x40 mm CABEZA PLANA	22	F29  PREGO 10X10 COM CABEÇA 10x10 NAIL WITH HEAD CLAVO CON CABEZA DE 10x10	65
F31  SUPORTE ANGULAR PLÁSTICA 22x15x12mm 22x15x12mm PLASTIC ANGLE BRACKET ESCUADRA DE ANGULO PLASTIC 22x15x12mm	8 NATURE NATURE NATURE	F32  TAMBOR MINIFIX 15mm 15mm CAM LOCK NUT TAMBOR MINIFIX 15mm	5
F33  TAMPA PLÁSTICA MINIFIX 15mm 15mm PLASTIC CAM LOCK COVER CUBIERTA PLASTIC MINIFIX 15mm	4 NATURE NATURE NATURE	F34  TAPA FURO ADESIVO 12mm 12 mm ADHESIVE HOLE COVERS CUBRE ORIFICIOS ADHESIVO DE 12 mm	30 NATURE NATURE NATURE

Ferramentas para montagem e instalação / Tools for assembly and installation / Herramientas de montaje e instalación
 Não fornecidas / Not Provided / No Provisto



PARAFUSADEIRA
 POWER SCREWDRIVER
 DESTORNILLADOR



FURADEIRA
 DRILL
 TALADRO



NÍVEL
 LEVEL
 NIVEL



TRENA
 TAPE MEASURE
 CINTA METRICA



MARTELO
 HAMMER
 MARTILLO



CHAVE PHILIPS E FENDA
 PHILLIPS SCREWDRIVER
 LLAVE PHILIPS



MONTAGEM
 ASSEMBLY
 MONTAJE

PASSO 1

STEP 1

PASO 1

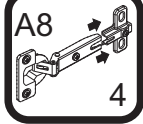
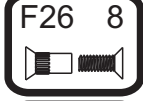
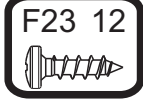

- 1 - Posicione as cantoneiras F5 na borda traseira das peças 1, e fixá-las com os parafusos F23 (4x14mm)
- 2 - Inserir as cavilhas F7 (8x30mm) nas peças 5
- 3 - Retirar o calço da dobradiça A8 e fixá-los nas peças 1, utilizando os parafusos de união F26 (17mm)

- 1 - Position corner braces F5 on the back edge of parts 1 and secure them with screws F23 (4x14 mm)
- 2 - Insert dowel pins F7 (8x30 mm) into parts 5
- 3 - Remove the shim from hinge A8 and attach them to pieces 1, using the F26 (17mm) joint screws.

- 1 - Coloque las cantoneras F5 en el borde posterior de las piezas 1 y fijelas con los tornillos F23 (4x14 mm)
- 2 - Inserte los tarugos F7 (8 x 30 mm) en las piezas 5
- 3 - Fije las cuñas A8 a las piezas 1 con los tornillos de unión F26 (17 mm)

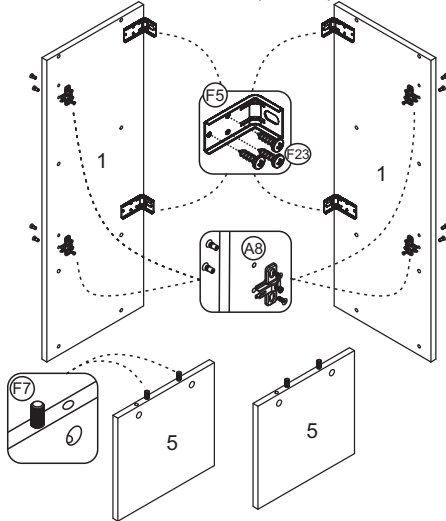

PASSO 3

STEP 3

PASO 3

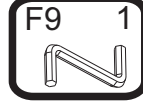
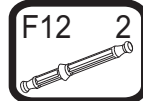

- 1 - Fixar as prateleira 4, nas laterais 1 com item F28 (7x40mm), utilizando chave zeta F9
- 2 - Inserir o acessório F12 na furação da prateleira 4, encaixar a peça 5 na furação da prateleira 4, inserir o acessório F32, utilizar uma chave de fenda para girar o tambor até travar

- 1 - Fix shelf 4 into sides 1 with item F28 (7x40 mm) using F9 shaped hex key
- 2 - Insert accessory F12 into the hole on the shelf 4, Fit part 5 into the hole on shelf 4, insert accessory F32, and use a screwdriver to turn the cam until it locks

- 1 - Fije los al estante 4 en la laterales 1 con el elemento F28 (7x40 mm). utilizando la llave zeta F9
- 2 - Insertar el accesorio F12 en el orificio de la estante 4, encajar la pieza 5 en el orificio de la estante 4, insertar el accesorio F32 y utilizar un destornillador para girar el tambor hasta que se trabé

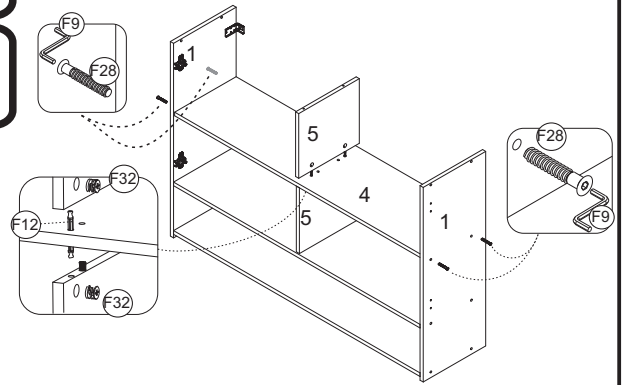

PASSO 2

STEP 2

PASO 2

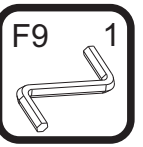

- 1 - Fixar as laterais 1 na base 2 com parafusos F28 (7x40mm), utilizando a chave zeta F9
- 2 - Fixar as peças 5 na prateleira 3 com parafusos F28 (7x40mm), utilizando a chave zeta F9
- 3 - Fixar as peças 1 na prateleira 3 com parafusos F28 (7x40mm), utilizando a chave zeta F9

- 1 - Fix the sides 1 to the base 2 with screws F28 (7x40mm), using the zeta F9 key
- 2 - Fix parts 5 on shelf 3 with screws F28 (7x40mm), using the zeta wrench F9
- 2 - Fix parts 1 on shelf 3 with screws F28 (7x40mm), using the zeta wrench F9

- 1 - Fijar los lados 1 a la base 2 con tornillos F28 (7x40mm), usando la tecla zeta F9
- 2 - Fijar las piezas 5 en el estante 3 con tornillos F28 (7x40mm), usando la llave zeta F9
- 3 - Fijar las piezas 1 en el estante 3 con tornillos F28 (7x40mm), usando la llave zeta F9

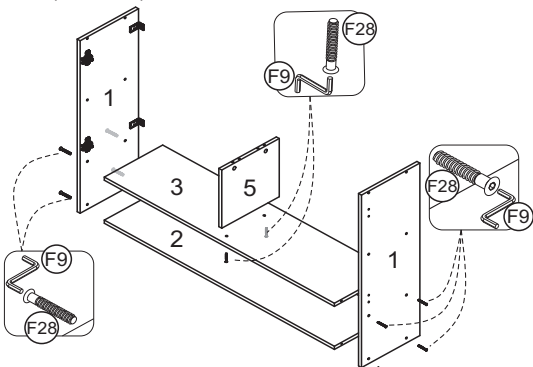

PASSO 4

STEP 4

PASO 4

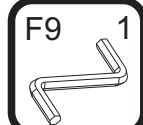

- 1 - Fixar o tampo 3 nas laterais 1 e na divisão 5, com parafusos F28 (7x40mm), utilizando a chave zeta F9

- 1 - Secure top 3 on the sides 1 and on divider 5, with screws F28 (7x40 mm), using S-shaped hex key F9

- 1 - Fije la tapa 3 a los laterales 1 y a la división 5, con tornillos F28 (7x40 mm), utilizando la llave de zeta F9

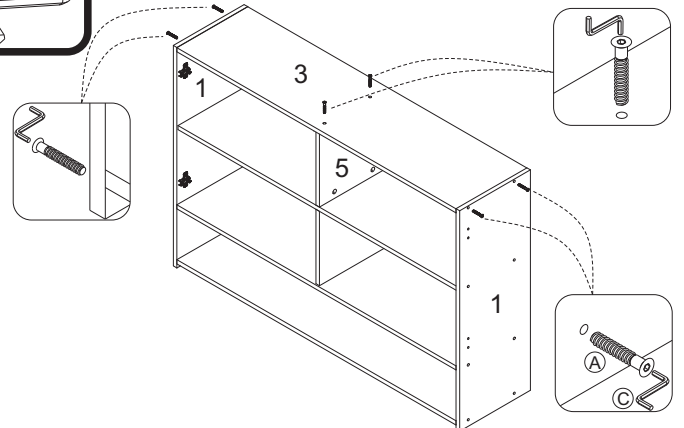

PASSO 5

STEP 5

PASO 5

F29 65



F11 12



- 1 - Alinhar a peça 9 e fixá-la com pregos F29 (10x10) na parte de cima e nas laterais, depois fixar a outra peça 10 com pregos F29 (10x10) na parte inferior e laterais
- 2 - Na junção entre as peças 9 e 10 utilizar os pregos F29 (10x10) com o fixador metálico F11

- 1 - Alinee la pieza 9 y fijela con clavos F29 (10x10) en la parte superior y en los laterales. Después fije la otra pieza 10 con clavos F29 (10x10) en la parte inferior y en los laterales.
- 2 - Para unir las piezas 9 y 10, utilice clavos F29 (10x10) con sujetador metálico F11

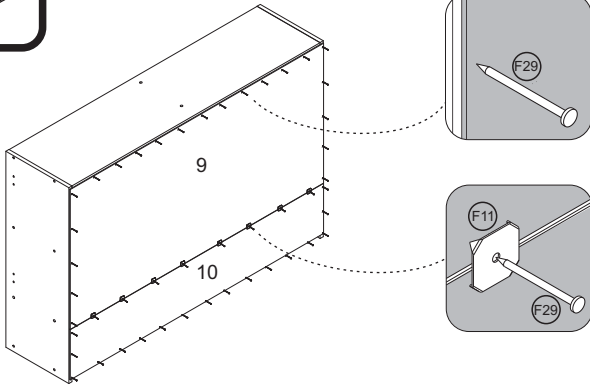

PASSO 7

STEP 7

PASO 7

F31 8



F23 16

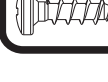

- 1 - Fixar a moldura 8, e molduras laterais 7 com suporte angular F31 e parafuso F23 (4x14)

- 1 - Fix molding 8, side moldings 7 with angle bracket F31 and screw F23 (4x14)

- 1 - Fije el marco 10, los marcos laterales 7 con la escuadra de ángulo F31 y los tornillos F23(4x14 mm)

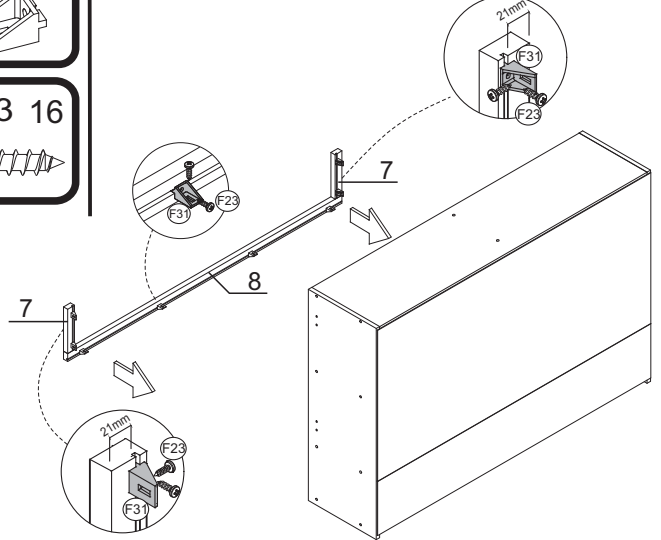

PASSO 6

STEP 6

PASO 6

F2 4



F22 4



FIXAÇÃO NA PAREDE (ALVENARIA)

ATENÇÃO: Antes de fixar o armário na parede verifique se o local possui condições adequadas para suportar o produto.

- 1 - Posicione o armário na parede e alinhe-o utilizando um nível
- 2 - Fure a parede com a broca de 8mm através do furo da cantoneira
- 3 - Insira o conjunto de parafuso e bucha no furo e aperte até o final para travar

SECURING TO WALL (MASONRY)

ATTENTION: Before securing the cabinet to the wall, check whether the location has suitable conditions to support the product.

- 1 - Position the cabinet on the wall and align it using a level
- 2 - Drill wall with 8 mm bit through the hole in the corner brace
- 3 - Insert the screw and anchor assembly into the hole and tighten to the end in order to lock into place

FIJACIÓN EN LA PARED (MAMPOSTERÍA)

ATENCIÓN: Antes de fijar el mueble a la pared, compruebe que la ubicación es adecuada y puede soportar el peso del producto.

- 1 - Coloque el armario en la pared y alinéelo con un nivel
- 2 - Taladre la pared con la broca de 8 mm a través del orificio de la cantonera
- 3 - Inserte el conjunto de tornillo y taco en el orificio y apriételo hasta el

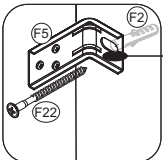

FURAR AQUI / DRILL HERE / PERFORAR

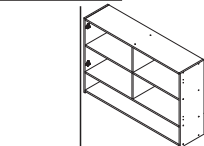

OBS: No final deste manual, verifique sugestões alternativas de instalação do produto em paredes que não sejam de alvenaria (gesso acartonado/drywall)

NOTE: At the end of this manual, see alternative suggestions for installing the product on non-masonry walls (plasterboard/drywall)

OBS: Al final de este manual, consulte las sugerencias alternativas para instalar el producto en paredes que no sean de mampostería (yeso acartonado/pared seca)

PASSO 8

STEP 8

PASO 8

F23 8

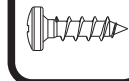

A8 4

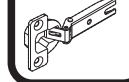

- 1 - Encaixar a dobradiça A8 nas portas e fixá-las com os parafusos F23 (4x14mm)

- 1 - Fit hinge A8 to the doors and secure them with screws F23 (4x14 mm)

- 1 - Coloque la bisagra A8 en las puertas fijelas con los tornillos F23 (4x14 mm)

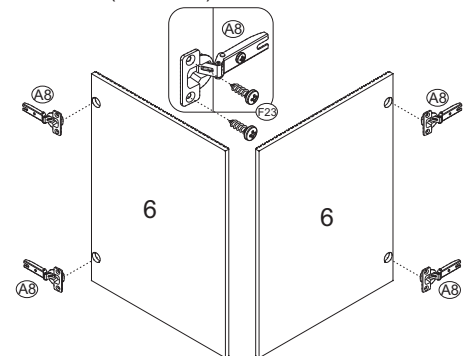

PASSO 9

STEP 9

PASO 9

A8 4

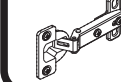

- 1 - Para montar a porta, encaixe a dobradiça no calço travando-a no parafuso indicado com o número 1 abaixo:

- 1 - To assemble the door, fit hinge onto hinge base plate, locking it onto the screw indicated with # 1 below:

- 1 - Para montar la puerta, encaje la bisagra en la cuña, bloqueándola en el tornillo indicado con el número 1 a continuación:

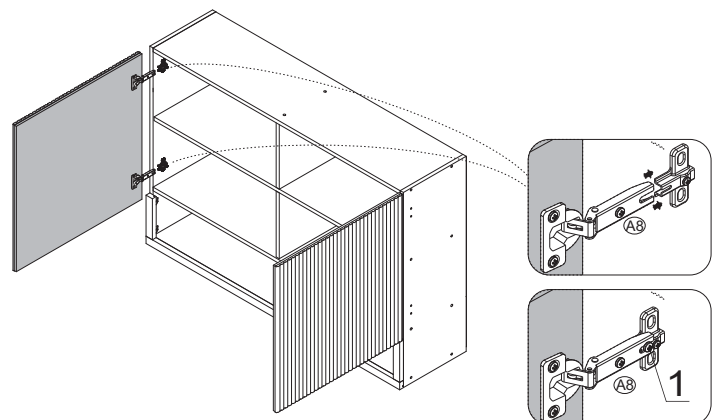

PASSO 10

STEP 10

PASO 10

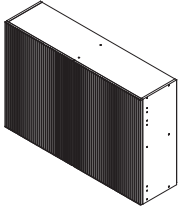

Para regulagem das portas siga as instruções conforme números abaixo:

- 1 - Se precisar subir ou abaixar um pouco a porta desaperte um pouco os parafusos indicados com o número 1, reposicione e aperte novamente
- 2 - Se precisar empurrar a porta um pouco mais para dentro ou puxá-la para fora, desaperte um pouco o parafuso indicado com o nº 2, reposicione e aperte novamente
- 3 - Se precisar alinhar as portas um pouco mais para o centro ou em direção as laterais, utilize uma chave philips para girar o parafuso indicado com o nº 3 até posicionar a porta da forma desejada

To adjust the doors, follow the instructions according to the numbers below:

- 1 - If you need to raise or lower the door a little, loosen the screws indicated with # 1, reposition and tighten again
- 2 - If you need to push the door a little further in or pull it out, loosen the screw indicated by # 2 a little, reposition it and tighten it again
- 3 - If you need to align the doors a little more towards the center or towards the sides, use a Philips screwdriver to turn the screw indicated by # 3 until you position the door as desired.

Para ajustar las puertas, siga las instrucciones de las figuras siguientes:

- 1 - Si necesita subir o bajar un poco la puerta, afloje los tornillos indicados con el número 1, vuelva a colocarlos y apriételes de nuevo
- 2 - Si necesita empujar la puerta un poco más hacia dentro o afuera, afloje un poco el tornillo indicado con el número 2, vuelva a colocarlo y apriétele de nuevo
- 3 - Si necesita alinear las puertas un poco más hacia el centro o hacia los lados, utilice un destornillador philips para girar el tornillo indicado con el número 3 hasta que la puerta quede colocada de la forma deseada

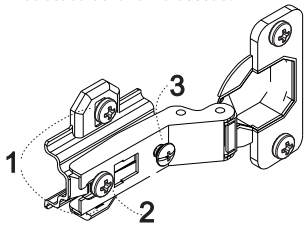

PASSO 11

STEP 11

PASO 11



Para fazer o acabamento dos módulos siga os passos abaixo:

- 1 - Cole o tapa furo adesivo F34 (12mm) sobre todos os parafusos aparentes
- 2 - Encaixe a tampa plástica F6 sobre todas as cantoneiras metálicas
- 3 - Cole os batentes de silicone F33 nos cantos inferiores e superiores de todas as portas

To finish the modules, follow the steps below:

- 1 - Stick adhesive hole covers F 34(12 mm) over all visible screws
- 2 - Fit plastic covers F6 over all metal corners
- 3 - Stick silicone bumpers F33 to the bottom and top corners of all doors

Para terminar el armado de los módulos, siga los pasos que se indican a continuación:

- 1 - Pegue el cubre orificio adhesivo F34 (12 mm) sobre todos los tornillos a la vista
- 2 - Coloque la cubierta de plástico F6 sobre todas las cantoneras metálicas
- 3 - Pegue los topes de silicona F33 en las esquinas inferior y superior de todas las puertas

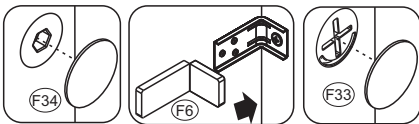

ATENÇÃO: Caro(a) cliente, na ferragem desse produto contém componentes para instalação do móvel em parede de alvenaria. Para fixação do armário em paredes de gesso acartonado/drywall, é necessário adquirir, em uma loja de material de construção, a ferragem específica para esses tipos de parede.

ATTENTION: Dear customer, the hardware of this product contains components for installing the unit on a masonry wall. To secure the cabinet to plasterboard/drywall walls, it is necessary to purchase specific hardware for these types of walls at a hardware store.

ATENCIÓN: Estimado cliente, los herrajes de este producto contienen componentes para instalar el mueble en un muro de mampostería. Para fijar el armario a las paredes de yeso acartonado/pared seca, tendrá que comprar los herrajes específicos para este tipo de paredes en una tienda de materiales de construcción



- 1 - Fure a parede de acordo com o diâmetro da bucha
1 - Drill the wall according to the anchor diameter
1 - Taladre la pared en función

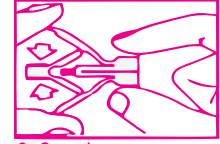

- 2 - Comprima as asas da bucha antes de introduzi-la
2 - Compress the wings of the anchor before inserting it
2 - Comprima las alas del taco antes de insertarlo

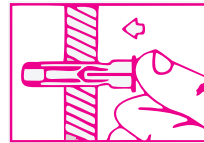

- 3 - Introduza a bucha no furo da parede
3 - Insert the anchor into the hole in the wall
3 - Inserte el taco en el agujero de la pared

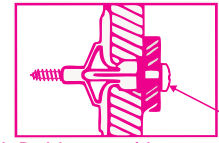

- 4 - Posicione o armário com a cantoneira sobre a bucha e fixe-o com um parafuso
4 - Position the cabinet with the corner brace over the anchor and secure it with a screw
4 - Coloque el armario con la cantonera sobre el taco y fijela con un tornillo

Aperte o parafuso até a fixação estar segura
Tighten the screw until securely affixed
Apriete el tornillo hasta que la fijación quede firme

OPÇÃO 1 - FIXAÇÃO GESSO/DRYWALL - BUCHA FLY
OPTION 1 - SECURING ON PLASTERBOARD/DRYWALL - WINGED ANCHOR
OPCIÓN 1 - FIJACIÓN EN YESO/PARED SECA - TACO CON ALAS

ATENÇÃO: Caro(a) cliente, na ferragem desse produto contém componentes para instalação do móvel em parede de alvenaria. Para fixação do armário em paredes de gesso acartonado/drywall, é necessário adquirir, em uma loja de material de construção, a ferragem específica para esses tipos de parede

ATTENTION: Dear customer, the hardware of this product contains components for installing the unit on a masonry wall. To secure the cabinet to plasterboard/drywall walls, it is necessary to purchase specific hardware for these types of walls at a hardware store.

ATENCIÓN: Estimado cliente, los herrajes de este producto contienen componentes para instalar el mueble en un muro de mampostería. Para fijar el armario a las paredes de yeso acartonado/pared seca, tendrá que comprar los herrajes específicos para este tipo de paredes en una tienda de materiales de construcción

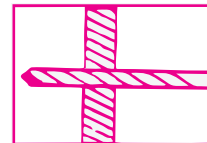

- 1 - Fure a parede de acordo com o diâmetro da bucha
1 - Drill the wall according to the diameter of the anchor
1 - Taladre la pared en función del diámetro del taco

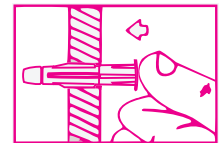

- 2 - Introduza a bucha no furo da parede
2 - Insert the anchor into the hole in the wall
2 - Inserte el taco en el agujero de la pared

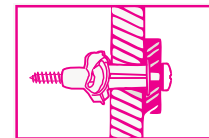

- 3 - Posicione o armário com a cantoneira sobre a bucha e fixe-o com um parafuso. Aperte o parafuso até a fixação estar segura
3 - Position the cabinet with the corner brace over the anchor and secure it with a screw. Tighten the screw until securely affixed
3 - Coloque el armario con la cantonera sobre el taco y fijela con un tornillo. Apriete el tornillo hasta que la fijación quede firme

OPÇÃO 2 - FIXAÇÃO GESSO/DRYWALL - BUCHA MU
OPTION 2 - SECURING ON PLASTERBOARD/DRYWALL - M.U. ANCHOR
OPCIÓN 2 - FIJACIÓN EN YESO/PARED SECA - TACO MU

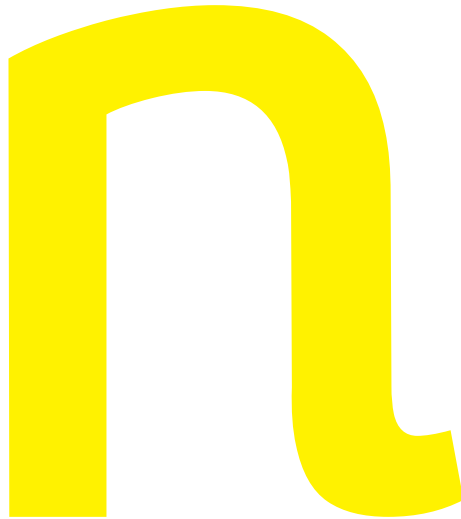

neshher

ARMÁRIO GELADEIRA 1 PORTA BASCULANTE NESHER SIMONE MENDES 80CM 100% MDF

NESHER SIMONE MENDES OVER-THE-FRIDGE
CABINET WITH 1 LIFT-UP DOOR 80 CM 100% MDF

ARMARIO PARA HELADERA CON 1 PUERTA
BÁSCULA NESHER SIMONE MENDES DE 80 CM 100 % MDF



A marca da gestão florestal responsável

The mark of responsible forest management

La marca de la gestión forestal responsable

FSC® C168299

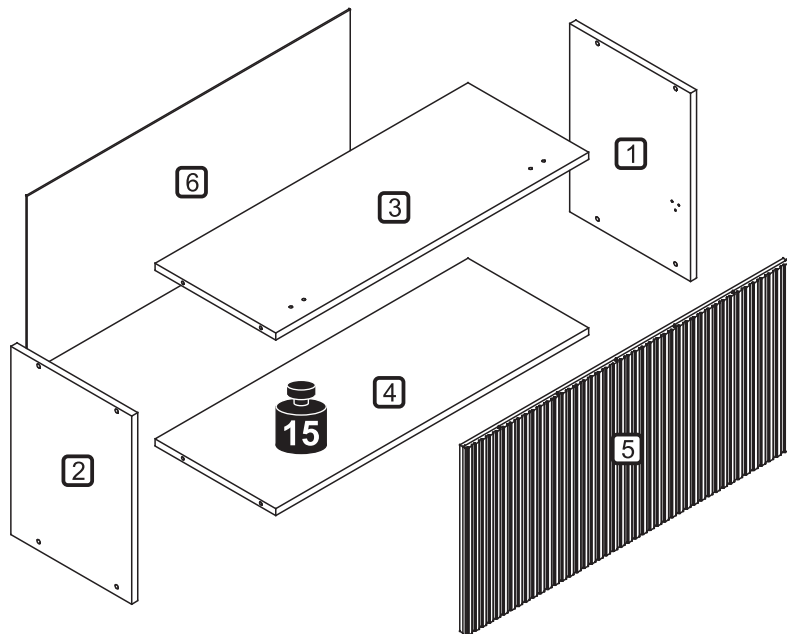
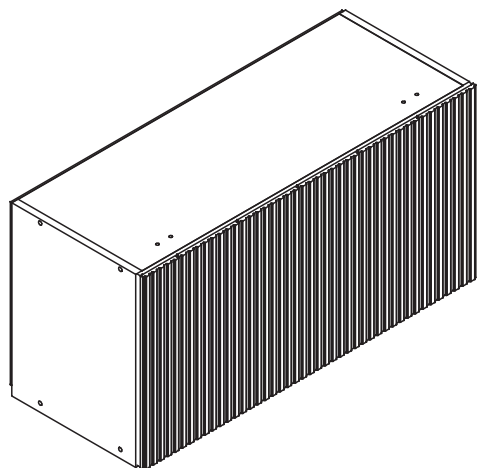

Peso máximo suportado
Maximum weight supported
Peso máximo soportado



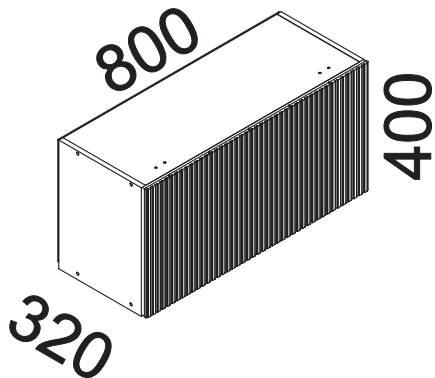



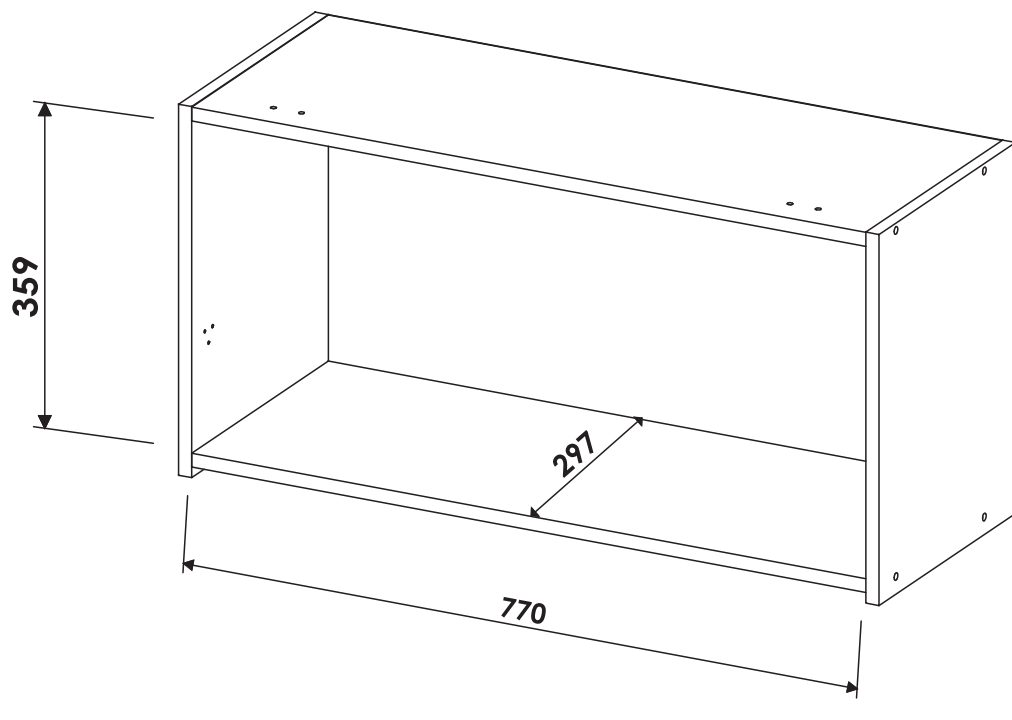

DIMENSÕES MÁXIMAS DO PRODUTO MONTADO
MAXIMUM DIMENSIONS OF THE ASSEMBLED PRODUCT
DIMENSIONES MÁXIMAS DEL PRODUCTO MONTADO

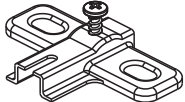
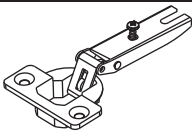

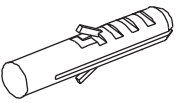
DIMENSÕES DOS ESPAÇOS INTERNOS (MEDIDAS EM MILÍMETROS)
DIMENSIONS OF INTERNAL SPACES (MEASUREMENTS IN MILLIMETERS)
DIMENSIONES DEL ESPACIO INTERNO (MEDIDAS EN MILÍMETROS)

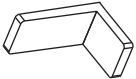
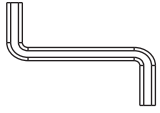
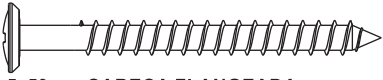

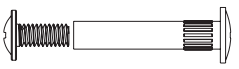
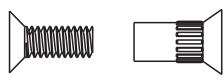
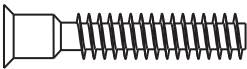
CÓDIGO CODE CÓDIGO	CARVALHO/GREIGE CARVALHO/GREIGE CARVALHO/GREIGE	DESCRIÇÃO DESCRIPTION DESCRIPCIÓN	MAT. PRIMA RAW MATERIAL MATERIA PRIMA	QUANT QTY CANT	MEDIDAS MEASUREMENTS MEDICIONES		
1	403557	LATERAL DIREITA / RIDE SIDE / PUERTA DERECHA	MDF	1	401	297	15
2	403558	LATERAL ESQUERDA / LEFT SIDE / PUERTA IZQUIERDA	MDF	1	401	297	15
3	403559	TAMPO / TOP / TAPA	MDF	1	770	297	15
4	403503	BASE / BASE / BASE	MDF	1	770	297	15
5	403538	PORTA / DOOR / PUERTA	MDF	1	798	399	18
6	402853	FUNDO TRASEIRO / BACK PANEL / FONDO POSTERIOR	DURATREE	1	795	379	2.5

CÓDIGO/DESCRIÇÃO CODE/DESCRIPTION CÓDIGO/DESCRIPCIÓN	QUANTIDADE QUANTITY CANTIDAD	CÓDIGO/DESCRIÇÃO CODE/DESCRIPTION CÓDIGO/DESCRIPCIÓN	QUANTIDADE QUANTITY CANTIDAD
A1 CALÇO PARA DOBRADIÇA 5mm 5 mm HINGE BASE PLATES CUÑA PARA BISAGRA DE 5 mm	 2	A6 DOBRADIÇA RETA CANECO 35mm STRAIGHT OVERLAY HINGE 35 mm CAZOLETA DE BISAGRA RECTA DE 35 mm	 2
A13 KIT PISTÃO A GÁS 80N - CÓDIGO 202592 KIT 80N GAS STRUT - CODE 202592 KIT PISTÓN A GAS 80N - CÓDIGO 202592	 1	F1 BATENTE DE SILICONE 12mm 12mm SILICONE BUMPER TOPE DE SILICONA 12mm	 2
F2 BUCHA DE PAREDE PLÁSTICA DE 8mm 8mm PLASTIC WALL ANCHOR TACOS DE PARED PLASTIC DE 8mm	 6	F5 CANTONEIRA METÁLICA PARA FIXAÇÃO NA PAREDE 54x28x28mm 54x28x28mm METAL CORNER BRACE FOR SECURING TO WALL CANTONERA METÁLICA PARA FIJACIÓN EN LA PARED 54x28x28mm	 2
F6 CAPA PLÁSTICA PARA CANTONEIRA 55X30X30mm 55X30X30mm PLASTIC COVER FOR CORNER BRACE TAPA DE PLÁSTICO PARA ÂNGULO 55X30X30mm	 2 NATURE NATURE NATURE	F9 CHAVE ZETA 4mm 4mm S-SHAPED HEX KEY LLAVE ZETA 4mm	 1
F22 PARAFUSO PHILIPS 5x50mm CABEÇA FLANGEADA PHILIPS SCREW 5x50 mm FLANG HEAD TORNILLO PHILIPS 5x50 mm CABEZA CON BRIDA	 2	F23 PARAFUSO PHILIPS 4x14mm CABEÇA PANEIA PHILIPS SCREW 4x14 mm PAN HEAD TORNILLO PHILIPS 4x14 mm CABEZA ALOMADA	 10
F25 PARAFUSO UNIÃO 28mm 28mm CONNECTOR SCREW TORNILLO DE UNIÃO 28mm	 3	F26 PARAFUSO UNIÃO 17mm 17mm CONNECTOR SCREW TORNILLO DE UNIÃO 17mm	 5
F28 PARAFUSO ALLEN S_PONTA 7x40mm CABEÇA CHATA ALLEN SCREW WITOUH TIP 7x40 mm FLAT HEAD TORNILLO ALLEN SIN PUNTA 7x40 mm CABEZA PLANA	 8	F29 PREGO 10X10 COM CABEÇA 10x10 NAIL WITH HEAD CLAVO CON CABEZA DE 10x10	 25
F34 TAPA FURO ADESIVO 12mm 12mm ADHESIVE HOLE COVERS CUBRE ORIFICIOS ADHESIVO DE 12mm	 8 NATURE NATURE NATURE		

Ferramentas para montagem e instalação / Tools for assembly and installation / Herramientas de montaje e instalación
Não fornecidas / Not Provided / No Provisto



PARAFUSADEIRA
POWER SCREWDRIVER
DESTORNILLADOR



FURADEIRA
DRILL
TALADRO



NÍVEL
LEVEL
NIVEL



TRENA
TAPE MEASURE
CINTA METRICA



MARTELO
HAMMER
MARTILLO



CHAVE PHILIPS E FENDA
PHILLIPS SCREWDRIVER
LLAVE PHILIPS



MONTAGEM
ASSEMBLY
MONTAJE

PASSO 1

STEP 1

PASO 1

- 1 - Posicione as cantoneiras F5 na borda traseira das peças 1 e 2, fixe-as com os parafusos F23 (4x14mm)
- 2 - Alinhe o suporte A13 do pistão na marcação da lateral e fixe-o com os parafusos do kit do pistão
- 3 - Fixar os calços A1 na peça 3 utilizando os parafusos de união F26 (17mm)

- 1 - Position corner braces F5 on the back edge of parts 1 and 2, secure them with screws F23 (4x14 mm)
- 2 - Align strut mount A13 with the marking on the side and secure it with the screws from the strut kit
- 3 - Secure base plates A1 on part 3 using connector screws F26 (17 mm)

- 1 - Coloque las cantoneiras F5 en el borde posterior de las piezas 1 y 2 y fíjelas con los tornillos F23 (4x14 mm)
- 2 - Alinee el soporte del pistón A13 en la marca del lateral y fíjelo con los tornillos del kit del pistón
- 3 - Fije las cuñas A1 a la pieza 3 con los tornillos de unión F26 (17 mm)

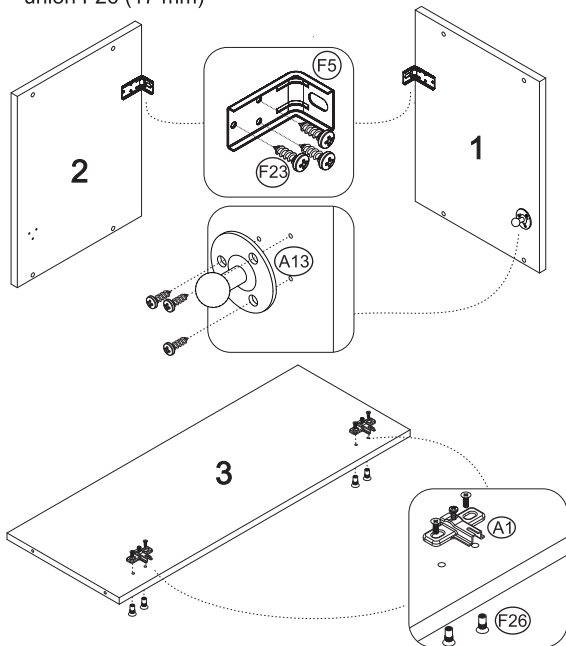
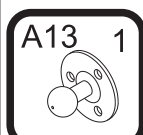
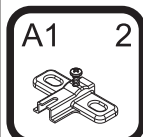
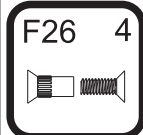
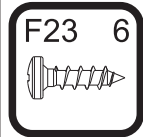
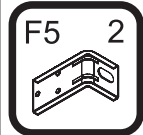

PASSO 4

STEP 4

PASO 4

FIXAÇÃO NA PAREDE (ALVENARIA)

ATENÇÃO: Antes de fixar o armário na parede verifique se o local possui condições adequadas para suportar o produto.

- 1 - Posicione o armário na parede e alinhe-o utilizando um nível
- 2 - Fure a parede com a broca de 8mm através do furo da cantoneira
- 3 - Insira o conjunto de parafuso e bucha no furo e aperte até o final para travar

SECURING TO WALL (MASONRY)

ATTENTION: Before securing the cabinet to the wall, check whether the location has suitable conditions to support the product.

- 1 - Position the cabinet on the wall and align it using a level
- 2 - Drill wall with 8 mm bit through the hole in the corner brace
- 3 - Insert the screw and anchor assembly into the hole and tighten to the end in order to lock into place

FIJACIÓN EN LA PARED (MAMPOSTERÍA)

ATENCIÓN: Antes de fijar el mueble a la pared, compruebe que la ubicación es adecuada y puede soportar el peso del producto.

- 1 - Coloque el armario en la pared y alínelo con un nivel
- 2 - Taladre la pared con la broca de 8 mm a través del orificio de la cantonera
- 3 - Inserte el conjunto de tornillo y taco en el orificio y apriételo hasta el

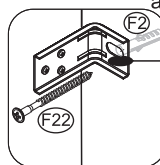

FURAR AQUI / DRILL HERE / PERFORAR

OBS: No final deste manual, verifique sugestões alternativas de instalação do produto em paredes que não sejam de alvenaria (gesso acartonado/drywall)
NOTE: At the end of this manual, see alternative suggestions for installing the product on non-masonry walls (plasterboard/drywall)
OBS: Al final de este manual, consulte las sugerencias alternativas para instalar el producto en paredes que no sean de mampostería (yeso acartonado/pared seca)

PASSO 2

STEP 2

PASO 2

- 1 - Fixar as laterais 1 e 2 nas peças 3 e 4 com os parafusos F28 (7x40mm), utilizando a chave zeta F9

- 1 - Secure sides 1 and 2 to parts 3 and 4 with screws F28 (7x40 mm), using hex key F9

- 1 - Fije los laterales 1 y 2 a las piezas 3 y 4 con tornillos F28 (7 x 40 mm), utilizando la llave zeta F9

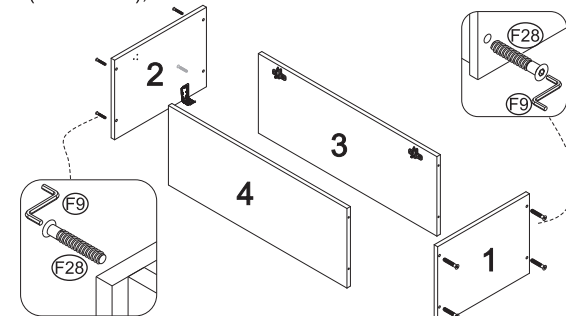
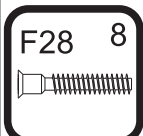

PASSO 5

STEP 5

PASO 5

- 1 - Fixar as dobradiças A6 na porta 5 com parafusos F23 (4x14mm)
- 2 - Fixar o suporte do pistão A13 na marcação da porta 5 com os parafusos do kit pistão

- 1 - Secure hinges A6 to door 5 with screws F23 (4x14 mm)
- 2 - Secure strut mount A13 to the marking on door 5 with the screws from the strut kit

- 1 - Fije las bisagras A6 a la puerta 5 con tornillos F23 (4x14 mm)
- 2 - Fije el soporte del pistón A13 a la marca de la puerta 5 con los tornillos del kit del pistón

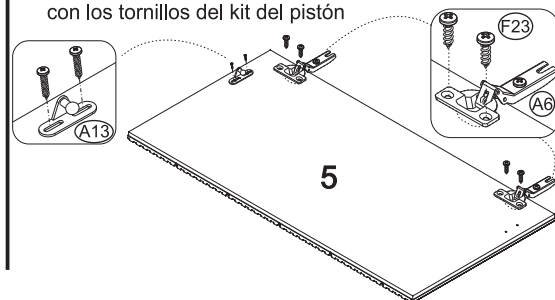
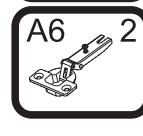
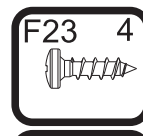

PASSO 3

STEP 3

PASO 3

- 1 - Alinhar a peça 6 e fixá-la com pregos F29 (10x10) nas laterais, tampo e base

- 1 - Align part 6 and secure it with nails F29 (10x10) on sides, top and base

- 1 - Alinee la pieza 6 y fíjela con clavos F29 (10x10) en los laterales, la tapa y la base

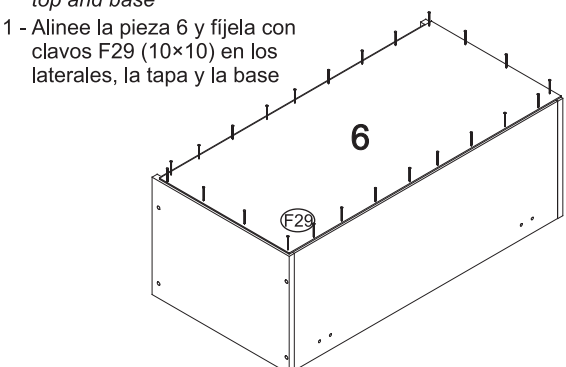

PASSO 6

STEP 6

PASO 6

- 1 - Para montar a porta, encaixe a dobradiça I no calço J travando-a no parafuso indicado com o número 1 abaixo:

- 1 - To assemble the door, fit hinge I onto hinge base plate J, locking it onto the screw indicated with # 1 below:

- 1 - Para montar la puerta, encaje la bisagra I en la cuña J, bloqueándola en el tornillo indicado con el número 1 a continuación:

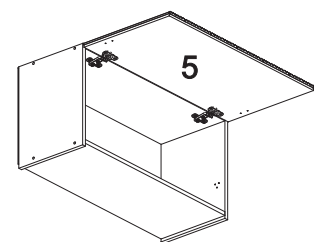
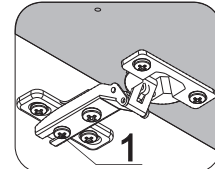
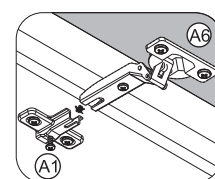
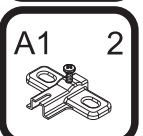
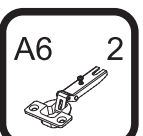

PASSO 07 INSTRUÇÃO DE MONTAGEM DO PISTÃO

STEP 07 STRUT ASSEMBLY INSTRUCTION

PASO 07 INSTRUCCIONES DE MONTAJE DEL PISTÓN

- 1 - Em ambas extremidades do pistão há uma capa protetora
 - 2 - Retire esta capa puxando-a para cima
 - 3 - Em seguida, sem a capa, encaixe o conector no local indicado
 - 4 - Recoloque a capa de proteção para travar o conector.
- 1 - At both ends of the strut there is a protective cover
 2 - Remove this cover by pulling it upwards
 3 - Then, without the cover, fit the connector in the indicated location
 4 - Replace the protective cover to lock the connector.
- 1 - Hay una cubierta protectora en los extremos del pistón
 2 - Retire esta tapa tirando de ella hacia arriba
 3 - A continuación, sin la tapa, encaje el conector en el lugar indicado
 4 - Vuelva a colocar la tapa protectora para bloquear el conector.

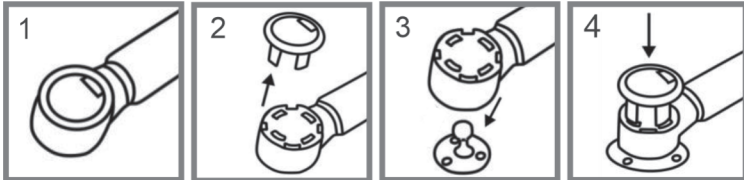

Repita o procedimento para fixar a outra extremidade do pistão

Repeat the procedure to secure the other end of the strut

Repita el procedimiento para fijar el otro extremo del pistón

PASSO 08 1 - Encaixe a haste do pistão A13 nos suportes que foram fixados na lateral 1 e na porta 5 nos passos anteriores.

STEP 08

PASO 08

- 2 - A parte mais grossa ficará apoiada na porta e a mais fina na lateral
- 1 - Fit strut rod A13 onto the mounts that were attached to side 1 and door 5 in the previous steps.
 2 - The thickest portion of the strut will be attached to the door and the thinnest portion will be attached to the side

- 1 - Encaixe o vástago do pistão A13 em nos suportes que se fixaram na lateral 1 e na porta 5 em os passos anteriores.
- 2 - A parte mais grossa se apoiará na porta e a mais fina em o lateral

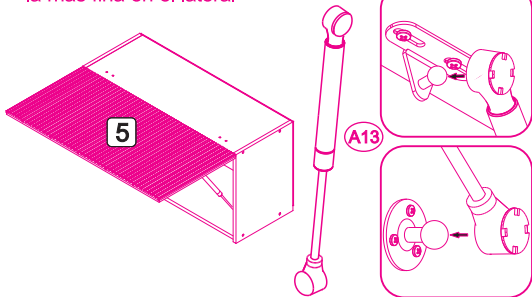

PASSO 09

STEP 09

PASO 09

- Para regulagem das portas siga as instruções conforme números abaixo:
- 1 - Se precisar subir ou abaixar um pouco a porta desaperte um pouco os parafusos indicados com o número 1, reposicione e aperte novamente
 - 2 - Se precisar empurrar a porta um pouco mais para dentro ou puxá-la para fora, desaperte um pouco o parafuso indicado com o nº 2, reposicione e aperte novamente
 - 3 - Se precisar alinhar as portas um pouco mais para o centro ou em direção as laterais, utilize uma chave philips para girar o parafuso indicado com o nº 3 até posicionar a porta da forma desejada

- To adjust the doors, follow the instructions according to the numbers below:
- 1 - If you need to raise or lower the door a little, loosen the screws indicated with # 1, reposition and tighten again
 - 2 - If you need to push the door a little further in or pull it out, loosen the screw indicated by # 2 a little, reposition it and tighten it again
 - 3 - If you need to align the doors a little more towards the center or towards the sides, use a Phillips screwdriver to turn the screw indicated by # 3 until you position the door as desired.

Para ajustar las puertas, siga las instrucciones de las figuras siguientes:

- 1 - Si necesita subir o bajar un poco la puerta, afloje los tornillos indicados con el número 1, vuelva a colocarlos y apriételes de nuevo
- 2 - Si necesita empujar la puerta un poco más hacia dentro o afuera, afloje un poco el tornillo indicado con el número 2, vuelva a colocarlo y apriétele de nuevo
- 3 - Si necesita alinear las puertas un poco más hacia el centro o hacia los lados, utilice un destornillador philips para girar el tornillo indicado con el número 3 hasta que la puerta quede colocada de la forma deseada

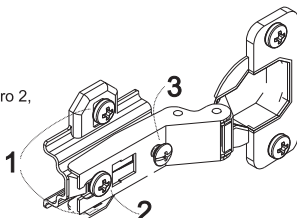

PASSO 10

STEP 10

PASO 10

Para fazer o acabamento dos módulos siga os passos abaixo:

- 1 - Cole o tapa furo adesivo F34 (12mm) sobre todos os parafusos aparentes
- 2 - Encaixe a tampa plástica F6 sobre todas as cantoneiras metálicas
- 3 - Cole os batentes de silicone F1 nos cantos superiores da porta basculante e da frente de gaveta

- To finish the modules, follow the steps below:
- 1 - Stick adhesive hole covers F34 (12 mm) over all visible screws
 - 2 - Fit plastic cover F6 over all metal corner braces
 - 3 - Stick silicone bumpers F1 to the upper corners of the pull-down door and drawer front

Para terminar el armado de los módulos, siga los pasos que se indican a continuación:

- 1 - Pegue el cubre orificio adhesivo F34 (12 mm) sobre todos los tornillos a la vista
- 2 - Coloque la cubierta de plástico F6 sobre todas las cantoneiras metálicas
- 3 - Pegue los toques F1 de silicona en las esquinas superiores de la puerta bascula y del frente del cajón

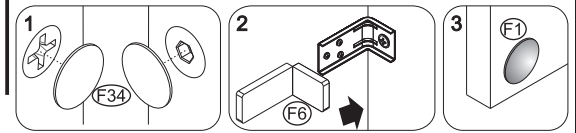
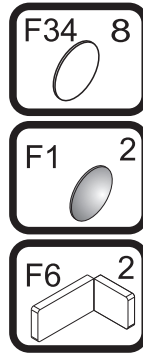

ATENÇÃO: Caro(a) cliente, na ferragem desse produto contém componentes para instalação do móvel em parede de alvenaria. Para fixação do armário em paredes de gesso acartonado/drywall, é necessário adquirir, em uma loja de material de construção, a ferragem específica para esses tipos de parede.

ATTENTION: Dear customer, the hardware of this product contains components for installing the unit on a masonry wall. To secure the cabinet to plasterboard/drywall walls, it is necessary to purchase specific hardware for these types of walls at a hardware store.

ATENCIÓN: Estimado cliente, los herrajes de este producto contienen componentes para instalar el mueble en un muro de mampostería. Para fijar el armario a las paredes de yeso acartonado/pared seca, tendrá que comprar los herrajes específicos para este tipo de paredes en una tienda de materiales de construcción

OPÇÃO 1 - FIXAÇÃO GESSO/DRYWALL - BUCHA FLY
 OPTION 1 - SECURING ON PLASTERBOARD/DRYWALL - WINGED ANCHOR
 OPCIÓN 1 - FIJACIÓN EN YESO/PARED SECA - TACO CON ALAS

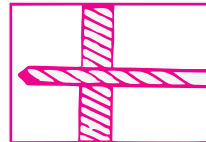

- 1 - Fure a parede de acordo com o diâmetro da bucha
- 1 - Drill the wall according to the anchor diameter
- 1 - Taladre la pared en función

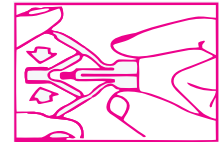

- 2 - Comprima as asas da bucha antes de introduzi-la
- 2 - Compress the wings of the anchor before inserting it
- 2 - Comprima las alas del taco antes de insertarlo

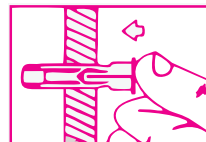

- 3 - Introduza a bucha no furo da parede
- 3 - Insert the anchor into the hole in the wall
- 3 - Inserte el taco en el agujero de la pared

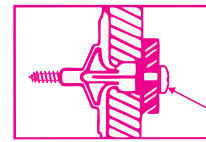

- 4 - Posicione o armário com a cantoneira sobre a bucha e fixe-o com um parafuso
- 4 - Position the cabinet with the corner brace over the anchor and secure it with a screw
- 4 - Coloque el armario con la cantonera sobre el taco y fijela con un tornillo

Aperte o parafuso até a fixação estar segura
 Tighten the screw until securely affixed
 Apriete el tornillo hasta que la fijación quede firme

ATENÇÃO: Caro(a) cliente, na ferragem desse produto contém componentes para instalação do móvel em parede de alvenaria. Para fixação do armário em paredes de gesso acartonado/drywall, é necessário adquirir, em uma loja de material de construção, a ferragem específica para esses tipos de parede.

ATTENTION: Dear customer, the hardware of this product contains components for installing the unit on a masonry wall. To secure the cabinet to plasterboard/drywall walls, it is necessary to purchase specific hardware for these types of walls at a hardware store.

ATENCIÓN: Estimado cliente, los herrajes de este producto contienen componentes para instalar el mueble en un muro de mampostería. Para fijar el armario a las paredes de yeso acartonado/pared seca, tendrá que comprar los herrajes específicos para este tipo de paredes en una tienda de materiales de construcción

OPÇÃO 2 - FIXAÇÃO GESSO/DRYWALL - BUCHA MU
 OPTION 2 - SECURING ON PLASTERBOARD/DRYWALL - M.U. ANCHOR
 OPCIÓN 2 - FIJACIÓN EN YESO/PARED SECA - TACO MU



- 1 - Fure a parede de acordo com o diâmetro da bucha
- 1 - Drill the wall according to the diameter of the anchor
- 1 - Taladre la pared en función del diámetro del taco

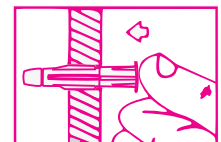

- 2 - Introduza a bucha no furo da parede
- 2 - Insert the anchor into the hole in the wall
- 2 - Inserte el taco en el agujero de la pared

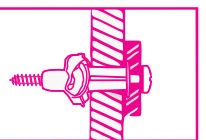

- 3 - Posicione o armário com a cantoneira sobre a bucha e fixe-o com um parafuso. Aperte o parafuso até a fixação estar segura
- 3 - Position the cabinet with the corner brace over the anchor and secure it with a screw. Tighten the screw until securely affixed
- 3 - Coloque el armario con la cantonera sobre el taco y fijela con un tornillo. Apriete el tornillo hasta que la fijación quede firme