











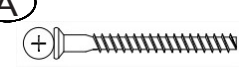











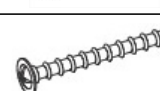

MB 1017

movelbento

daqui para sua casa

Joana Guindani Tonelo, 1952
95708-300 Bento Gonçalves - RS
Fone: 55 (54) 3454 7500
www.movelbento.com.br

| PEÇAS / PARTS / PARTES | ITEM | CÓDIGO / CODE | Dimensões / Dimensions (mm) | QTY |
|--|------|---------------|-----------------------------|-----|
| Tampo - Base / Top - Bottom / Tablero - Base | 1 | 76521 | 450 X 405 X 15 | 02 |
| Pilastra / Pilastra / Pilaster | 2 | 76523 | 405 X 70 X 15 | 01 |
| Pé de madeira 200mm / Leg 200 mm / Pata 200 mm | 3 | 75862 | 200 mm | 04 |
| Lateral direita / Right side / Lado derecho | 4 | 76528 | 1570 X 380 X 15 | 01 |
| Lateral esquerda / Left side / Lado izquierdo | 5 | 76522 | 1570 X 380 X 15 | 01 |
| Porta / Door / Puerta | 6 | 76650 | 1520 X 299 X 15 | 01 |
| Costa / Back / Fondo | 7 | 76520 | 1590 X 430 X 3 | 01 |
| Pilastra / Pilastra / Pilaster | 8 | 78116 | 350 X 60 X 15 | 02 |
| Pilastra / Pilastra / Pilaster | 9 | 78117 | 300 X 60 X 15 | 02 |
| Prateleira / Shelf / Estante | 10 | 76525 | 405 X 380 X 15 | 04 |
| Pilastra / Pilastra / Pilaster | 11 | 76524 | 1570 X 65 X 15 | 02 |

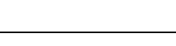
| ACCESSORY / ACCESORIOS | ITEM | QTY | (A) | (J) |
|---|------|-----|---|---|
| Parafuso / Screw / Tornillo 5 X 50 | (A) | 16 |  | (J)  |
| Tapa de furo / Hole cover / Tapa Agujero | (B) | 02 | (B)  | (K)  |
| Cavilha / Peg / Clavija 8 X 30 | (C) | 26 | (C)  | (L)  |
| Parafuso / Screw / Tornillo M 4 X 20 | (D) | 01 | (D)  | (M)  |
| Cola / Glue / Pegamento 12 g | (E) | 01 | (E)  | (N)  |
| Tambor minifix / Minifix drum / Tambor Minifix 15 mm | (F) | 16 | (F)  | (O)  |
| Haste minifix / Minifix Stand / Baqueta minifix | (G) | 16 | (G)  | (P)  |
| Parafuso C. chata / Screw / Tornillo 3,5 X 14 | (H) | 38 | (H)  | (Q)  |
| Prego / Nail / Clavo 10 X 10 | (I) | 60 | (I)  | (R)  |
| Parafuso C. panela / Screw / Tornillo 3,5 X 14 | (J) | 18 | (J)  | (S)  |
| Cantoneira / Metal angle / Ángulo de metal | (K) | 16 | (K)  | |
| Puxador ponto / Point puller / Extractor de puntos | (L) | 01 | (L)  | |
| Chapa metalica / Metal flat iron / Plancha metalica | (M) | 01 | (M)  | |
| Dobradiça / Hinge / bisagra 40 x 69,5 | (N) | 03 | (N)  | |
| Espaçador de porta / Door spacer / Espaciador de puerta 100 x 100 x 3 | (O) | 02 | (O)  | |
| Fecho magnético / Magnet clasp / Cierre magnético | (P) | 01 | (P)  | |
| Suporte de fixação / Mounnng bracket / Soporte de armario | (Q) | 01 | (Q) | |
| Parafuso C. Flangeado / Screw / Tornillo 4,5 x 45 | (R) | 01 | (R) | |
| Bucha / Plastic bushing / buje de plástico 8mm | (S) | 01 | (S) | |

Notas especiais:

1. Leia todas as instruções cuidadosamente antes de iniciar a montagem.
2. A montagem do produto deve ser em uma superfície limpa e plana. Aconselhamos a usar a própria embalagem para cobrir o chão para não danificar o produto.
3. Reserve uma área livre para montagem do produto.
4. Evite o contato com objetos pontiagudos.

Special notes:

1. Read all instructions carefully before starting assembly.
2. The product assembly must be felt on a clean and flat surface. We advise you to use the packaging itself to cover the floor and damage the product.
3. Reserve a free area for product assembly.
4. Avoid contact with sharp objects.

Notas especiales:

1. Lea todas las instrucciones detenidamente antes de comenzar el montaje.
2. El conjunto del producto debe sentirse sobre una superficie limpia y plana. Le recomendamos que utilice el propio embalaje para cubrir el suelo y dañar el producto.
3. Reserve un área libre para el montaje del producto.
4. Evite el contacto con objetos afilados.

**FERRAMENTAS NECESSÁRIAS
NECESSARY TOOLS
HERRAMIENTAS NECESARIAS**



optional / opcional

1

MONTAGEM DOS PÉS / LEG ASSEMBLY / MONTAJE DE PIES

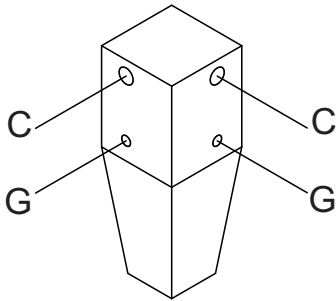
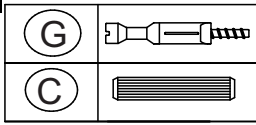
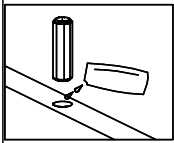
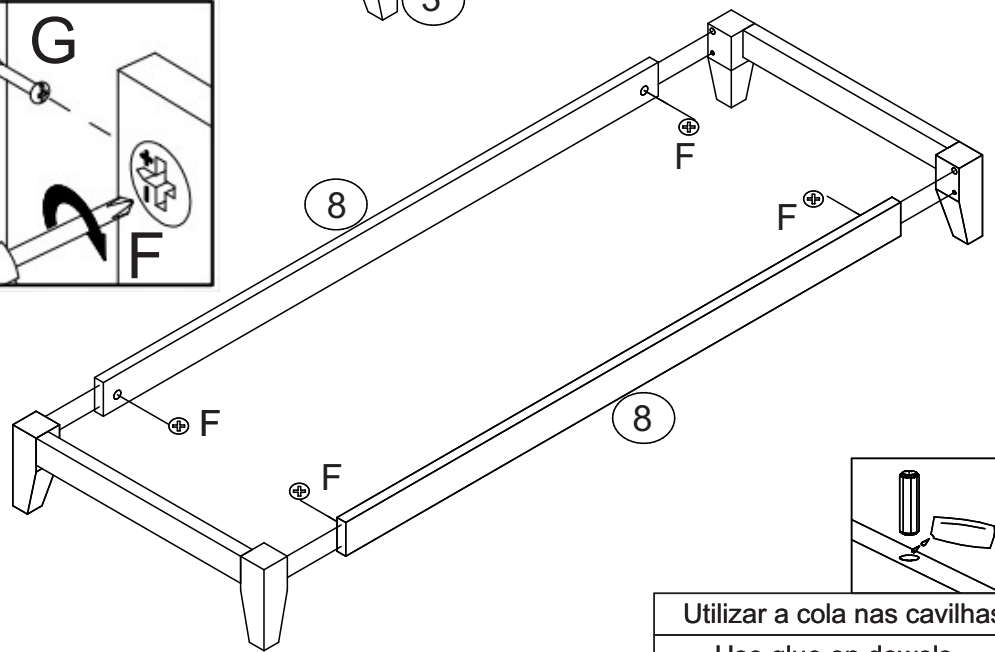
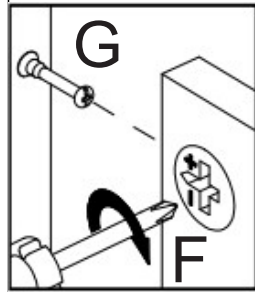
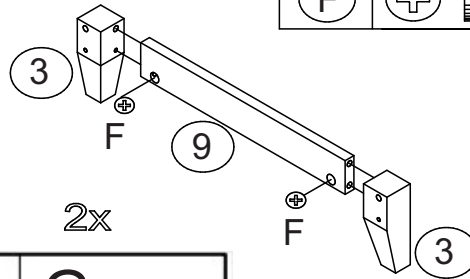
**3** x4

Utilizar a cola nas cavilhas

Use glue on dowels

Usa pegamento en las clavijas

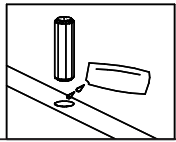

Utilizar a cola nas cavilhas

Use glue on dowels

Usa pegamento en las clavijas

2

PREPARAR AS PEÇAS / PREPARE THE PARTS / PREPARAR LAS PIEZAS

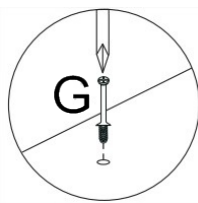
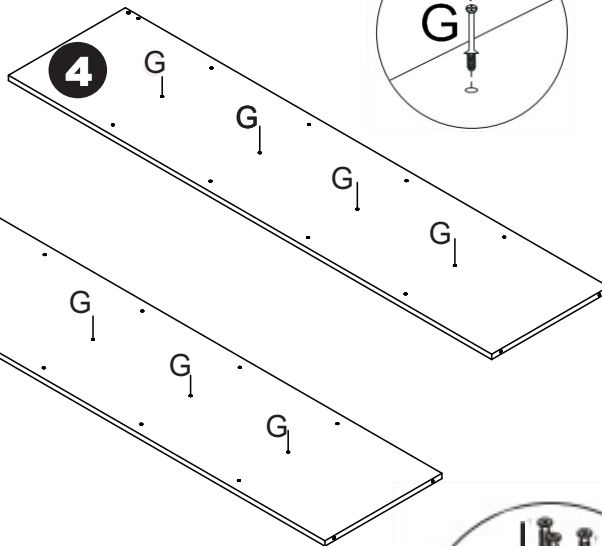
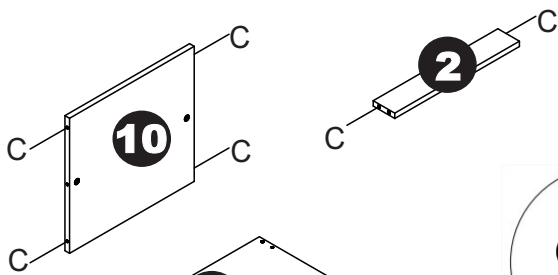
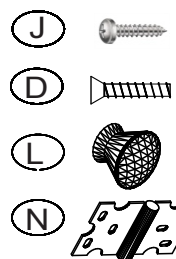
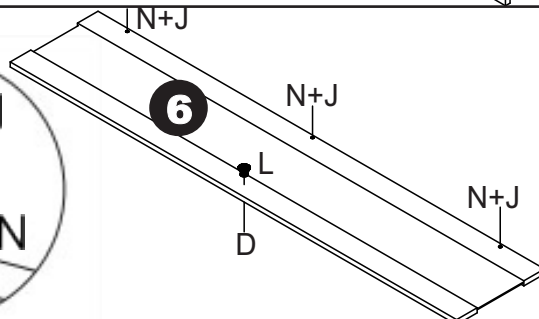
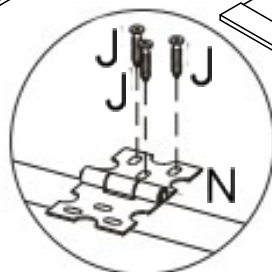
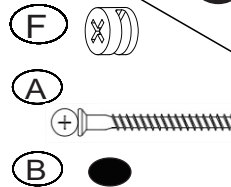
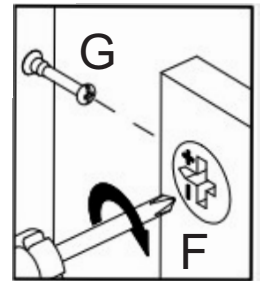
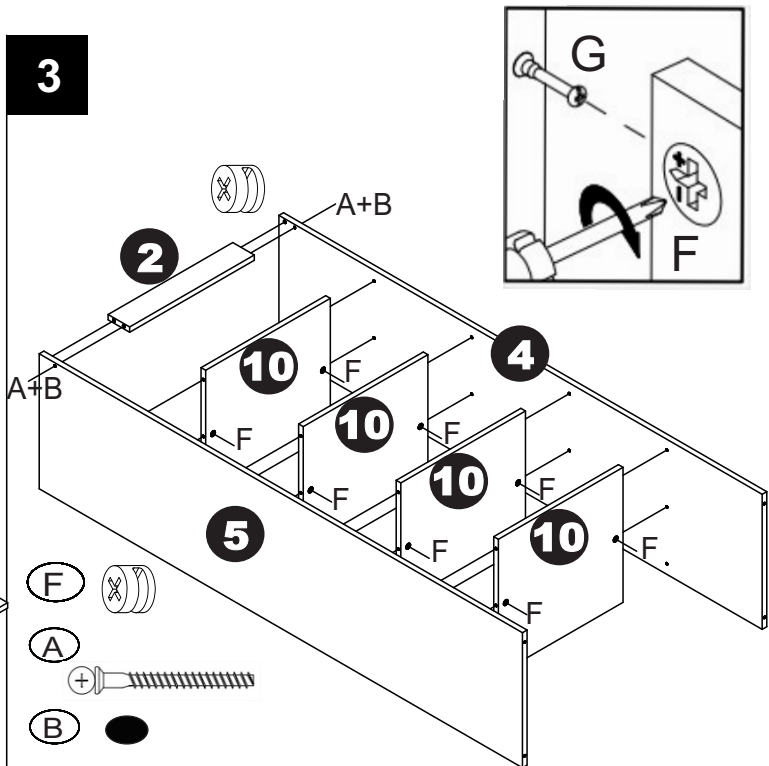
**3**

3

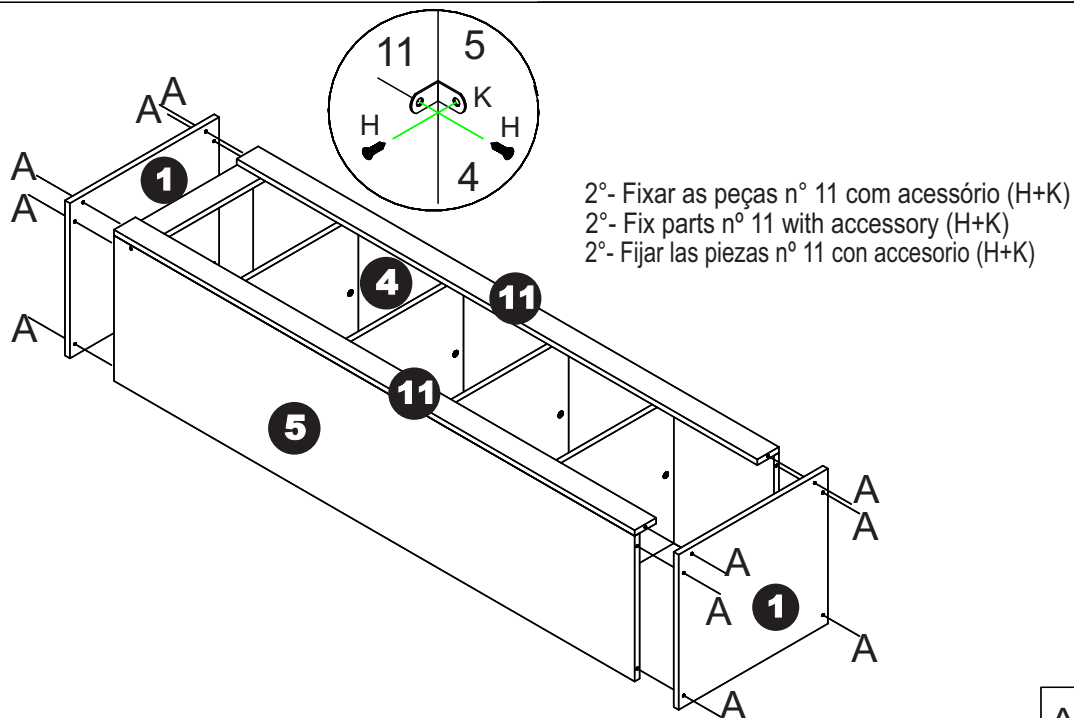

2° - Fixar as peças nº 11 com acessório (H+K)
 2° - Fix parts nº 11 with accessory (H+K)
 2° - Fijar las piezas nº 11 con accesorio (H+K)

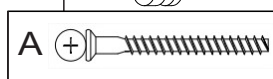
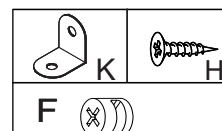

4

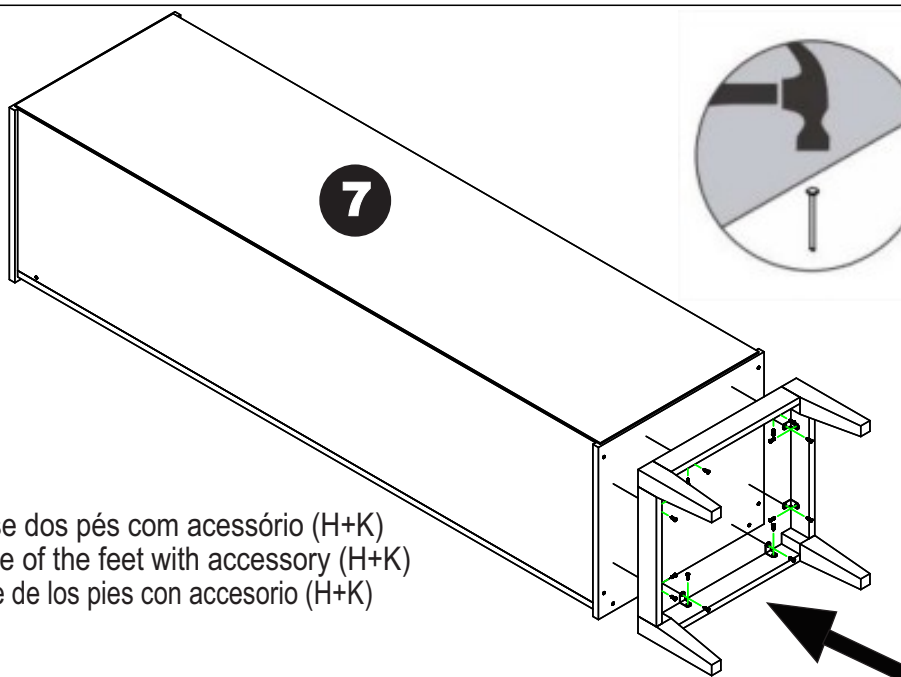

Fixar a base dos pés com acessório (H+K)
 Fix the base of the feet with accessory (H+K)
 Fijar la base de los pies con accesorio (H+K)

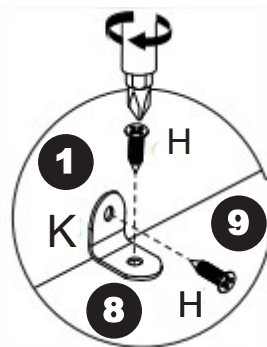

5

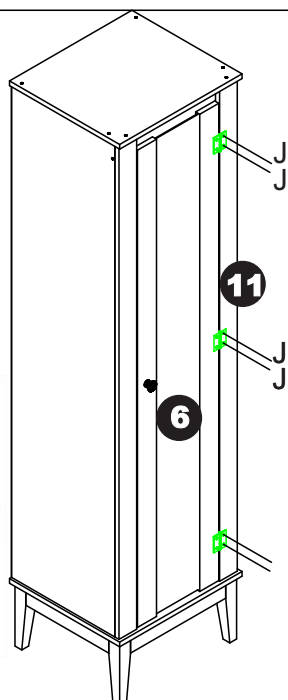

Usar o espaçador de porta (O) embaixo da mesma, para alinhar a porta corretamente
 Use the port spacer (O) underneath the port to align the port correctly
 Use el espaciador del puerto (O) debajo del puerto para alinear el puerto correctamente

2° - Fixar as porta (6) nas peças (11) com parafuso (J)
 2° - Fix the door (6) on the parts (11) with screw (J)
 2° - Fijar la puerta (6) en las partes (11) con tornillo (J)

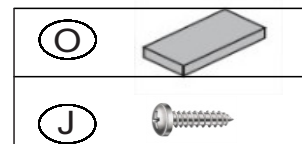
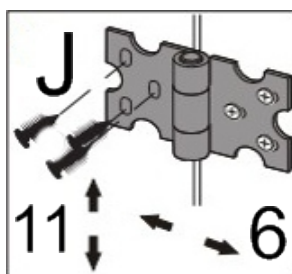
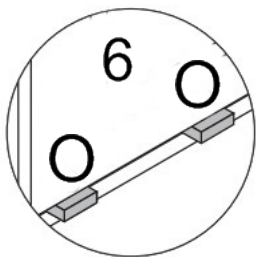

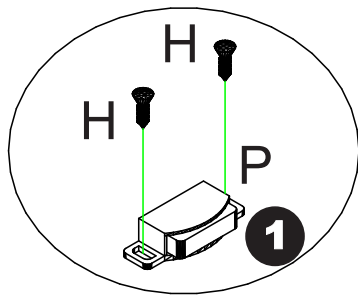
6

Parafusar o fecho magnético (P) na peças (1)
Screw the magnetic closure (P) onto the parts (1)
Enroscar el cierre magnético (P) en las piezas (1)

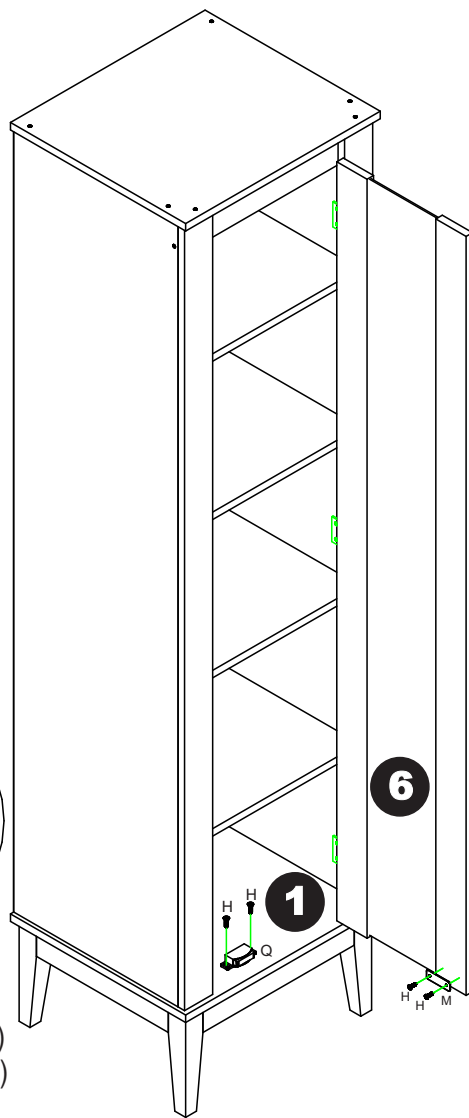

Parafusar o acessório (M) na porta (6)
Screw the accessory (M) onto the door (6)
Atornillar el accesorio (M) en la puerta (6)

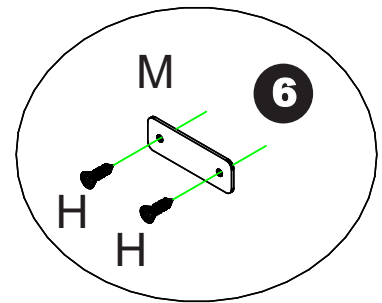
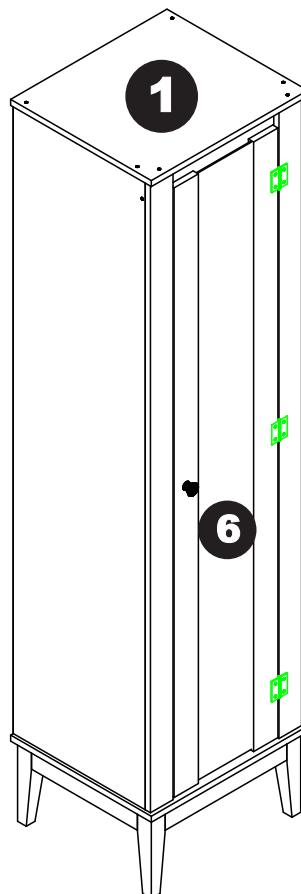
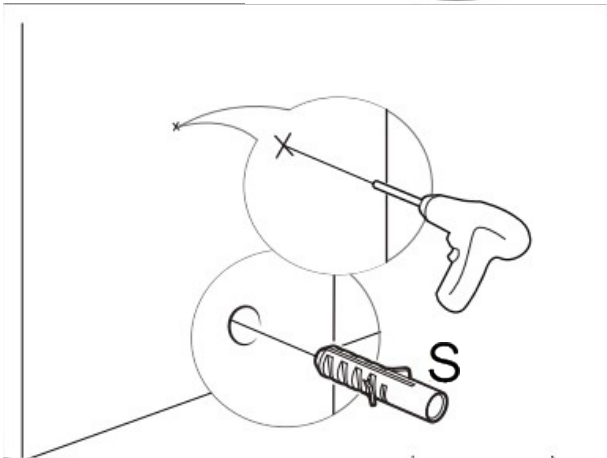
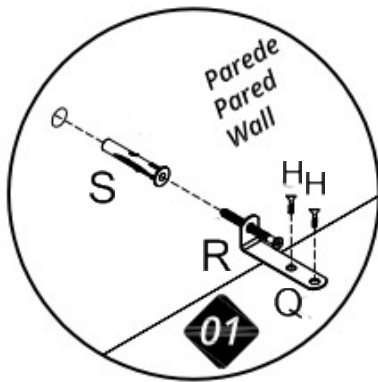
**7**

Atenção!

Para segurança, a fixação na parede é imprescindível.

For security, the fixation on the wall is essential.

Por seguridad, la fijación en ella pared es esencial.