

# MANUAL DE MONTAGEM

## INSTRUCCIONES DE MONTAJE

## ASSEMBLY INSTRUCTIONS

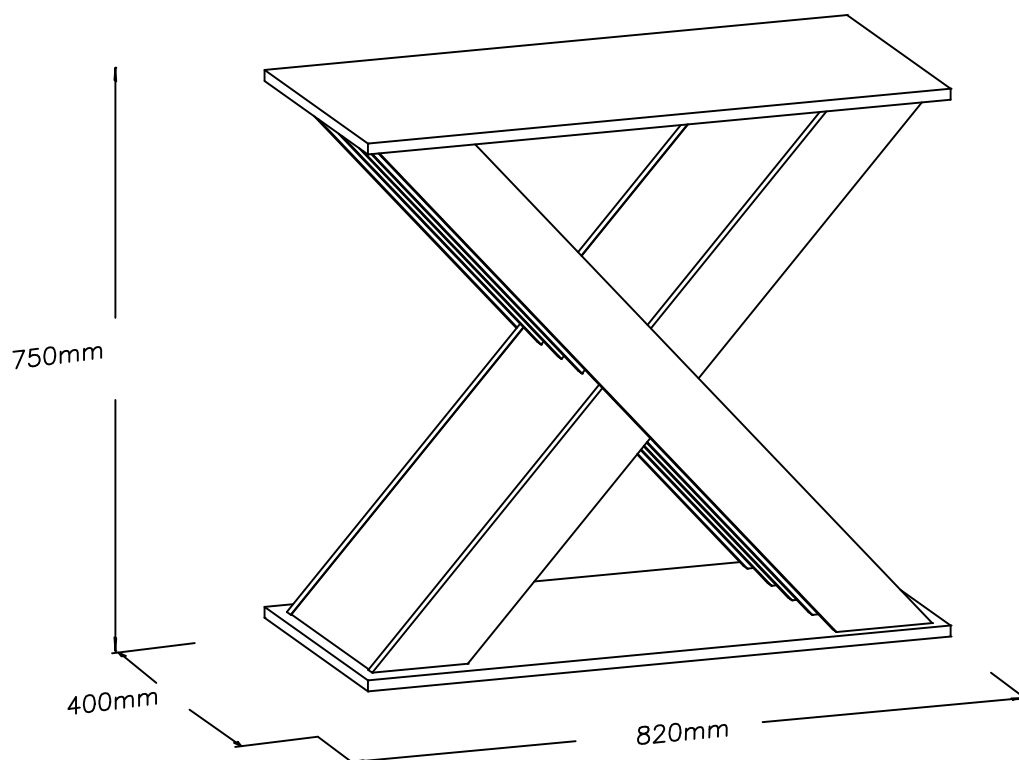

## ATENÇÃO / PRECAUCIÓN / ATTENTION:

- 1 – Ler atentamente todo o manual antes de iniciar a montagem do móvel.
- 2 – A montagem deve ser feita em uma superfície plana e limpa.
- 3 – Recomenda-se utilizar a embalagem do móvel para forrar e chão e assim não danificá-lo.
  - 1 – Lea cuidadosamente todo el manual antes de comenzar el montaje.
  - 2 – La instalación debe hacerse sobre una superficie plana y limpia.
  - 3 – Recomanda ser utilizado para empaquetar móvel a la línea y tierra y por lo tanto dañar ellos.
- 1 – Read the entire manual carefully before starting the furniture assembly.
- 2 – The assembly must be done on a flat and clean surface.
- 3 – It is recommended to use the packaging of the furniture to cover and floor and thus not to damage them.

## LIMPEZA E CONSERVAÇÃO / LIMPIEZA Y CONSERVACIÓN / CLEANLINESS AND CONSERVATION:

A limpeza do móvel deve ser feita com utilização de pano umedecido com água, podendo conter uma pequena quantidade de álcool. Não utilize produtos abrasivos.

La unidad de limpieza se debe realizar con el uso de paño humedecido con agua y puede contener una pequeña cantidad de alcohol. No utilice productos abrasivos.

The furniture should be cleaned with a cloth dampened with water and may contain a small amount of alcohol. Do not use abrasive products.

## GARANTIA / GARANTÍA / WARRANTY:

90 dias para defeitos de fabricação.

90 días a defectos de fabricación.

90 days for manufacturing defects.

## FERRAMENTAS NECESSÁRIAS / HERRAMIENTAS NECESARIAS / TOOLS REQUIRED:

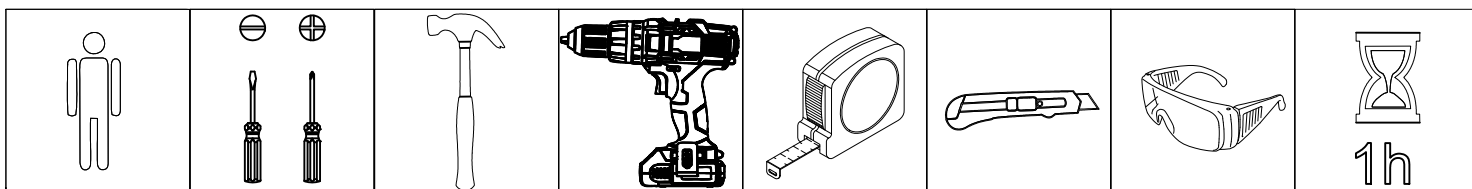

Acesse as dicas de  
montagem no Youtube

Accede a los consejos de  
montaje en Youtube.

Access the mounting tips on  
Youtube.

[www.youtube.com/MoveisKappesberg](http://www.youtube.com/MoveisKappesberg)



S:\Arquivos importantes\NÃO APAGAR.png



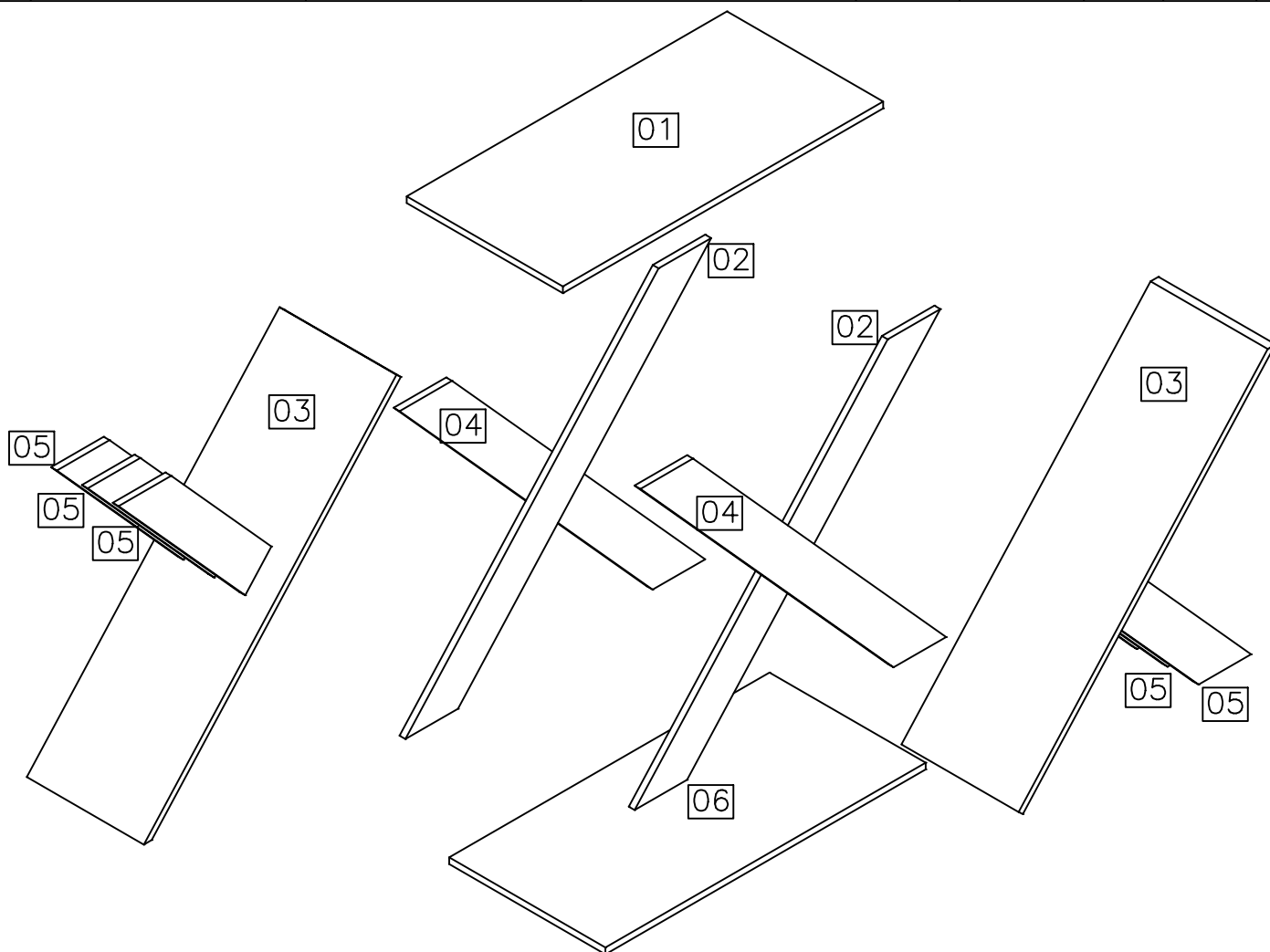

## Lista de peças / Lista de piezas / List of pieces

Código/ Código/ Code	Descrição	Descripción	Description	Quantidade/ Cantidad/ Amount	Comprimento/ Longitud/ Length (mm)	Largura/ Ancho/ Width (mm)	Espessura/ Espesor/ Thickness (mm)	Caixa/ Caja/ Box
01	Tampo	Tapa del cajón	Top of drawers	1	820	400	15	A
02	Lateral	Lateral	Side	2	1059	100	15	A
03	Divisória	División	Division	2	967	300	15	A
04	Travessa maior	Pieza cruzada mayor	Larger crosspiece	2	1059	100	15	A
05	Travessa menor	Pieza cruzada pequeño	Minor crosspiece	6	485	100	15	A
06	Base	Pieza de suelo	Base	1	820	400	15	A

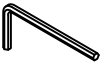
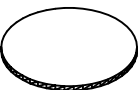

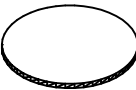
## Ferragem / Herrajes / Hardware

	Código/ Código/ Code	Descrição / Descripción / Description	Quan./ Cant./ Amou.
A	226	 Parafuso/ Tornillo/ Screw 4x40	44
B	10101	 Sapata ajustável/Zapato ajustable/Adjustable shoe	4
C	10109	 Chave allen/Clave allen/Allen key 6mm	1
D	FR=51255 (Freijo) CN/CNOW= 81769 (Canela) NG=63102 (Nogueira)	 Tapa furo/Tapa del agujero/Tap hole 13mm	29

D	CNOW =053286 (Off white)		Tapa furo/Tapa del agujero/Tap hole 13mm	2
E	58		Etiqueta marca/Tag label "Kappesberg"	1
F	491		Parafuso/ Tornillo/ Screw 4x25	4
G	10102		Bucha de parafuso/Casquillo de tornillo/Screw bushing	4
01 Saco pequeno para acessórios				

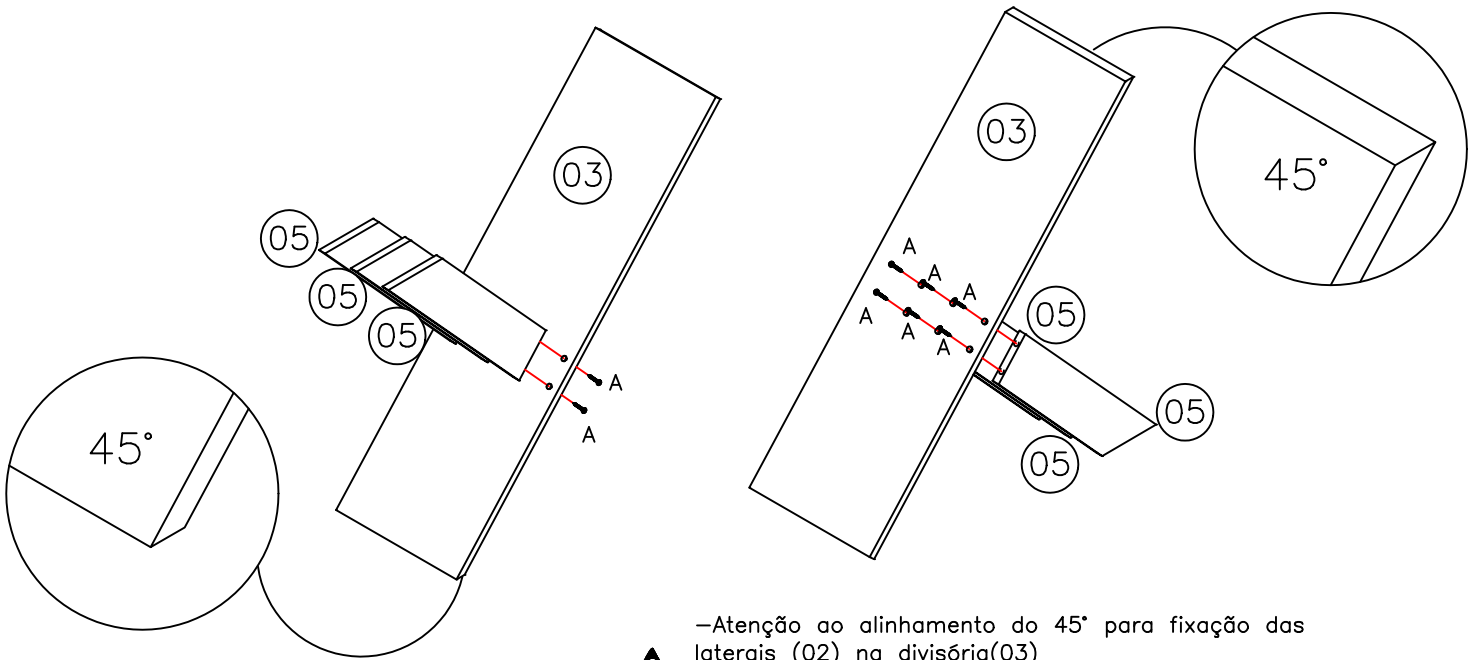

-Atenção ao alinhamento do 45° para fixação das laterais (02) na divisória(03)

-Atención a la alineación del 45o para la fijación de los lado (02) en la partición(03)

-Attention to the alignment of the 45° for fixing the side (02) in the centerpiece(03)

