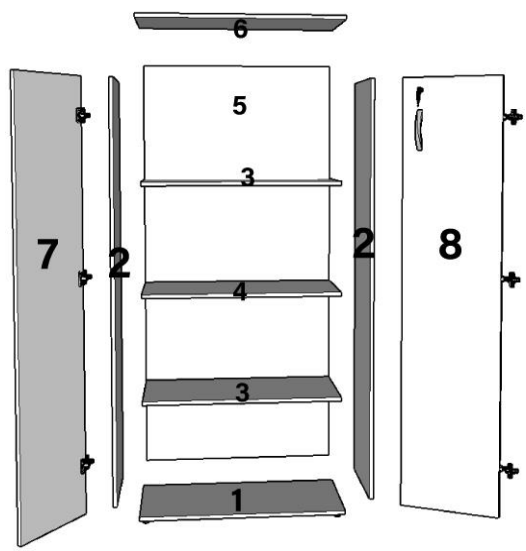

# MANUAL DE MONTAGEM ARMÁRIO ALTO 2P 30MM F15MM

## ACESSÓRIOS

A1	ADESIVO TAPA FURO		16
B1	BUCHA M6X10		4
B2	BATENTE L P/ FECHADURA		2
B3	BATENTE DE PORTA		1
C1	CAVILHA DE MADEIRA 6X30		16
C2	CAVILHA METALICA 6X8		8
D1	DISTANCIADOR DE FECHADURA		1
D2	DOBRADIÇA BRAÇO CURVO		6
D3	DOBRADIÇA CALÇO		6
F1	PUXADOR		2
F2	FECHADURA		1
M1	TAMBOR MINIFIX		16
M2	HASTE MINIFIX ROSCA SOBERBA		16
P1	PARAFUSO GERAL 3,5X14		44
P2	PARAFUSO 4,5X25		4
S1	SAPATA M6X14		4

VISTA EXPLODIDA	PEÇA	DESCRIÇÃO DA PEÇA	QUANTIDADE
	1	BASE	1
	2	LATERAL	2
	3	PRATELEIRA	2
	4	PRATELEIRA CENTRAL	1
	5	COSTAS	1
	6	TAMPO	1
	7	PORTA ESQUERDA	1
	8	PORTA DIREITA	1

### PASSO 01

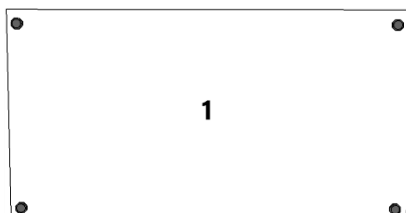

NAS 4 EXTREMIDADES FIXE A BUCHA "B1" E DEPOIS APERTE A SAPATA "S1".

### PASSO 02

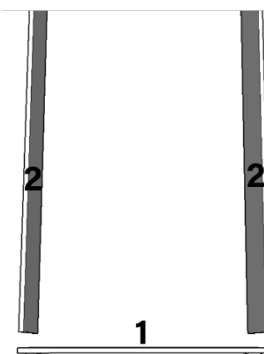

FIXAR LATERAIS "2" NA BASE "1". USE CAVILHA "C1" + HASTE "M2" NA BASE "1".

JÁ NAS LATERAIS "2", ENCAIXE O TAMBOR MINIFIX "M1" E APERTE-O.

PASSO 03

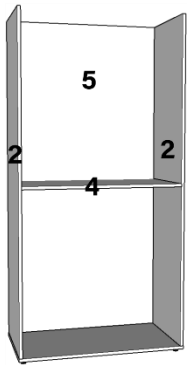

FIXAR COSTAS "5" E LOGO APÓS A PRATELEIRA CENTRAL "4" NAS LATERAIS "2".

USE CAVILHA "C1" + HASTE MINIFIX "M2" NAS LATERAIS "2" E TAMBOR MINIFIX "M1" NAS COSTAS "5".

PASSO 04

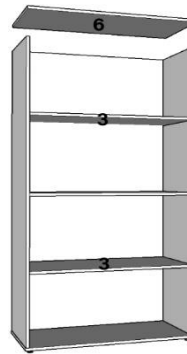

FIXAR TAMPO "6" NAS LATERAIS "2".

USE CAVILHA "C1" + HASTE MINIFIX "M2" NO TAMPO "6" E TAMBOR "M1" NAS LATERAIS "2".

FIXAR PRATELEIRAS "3" USANDO CAVILHA "C2" NAS LATERAIS "2".

PASSO 05

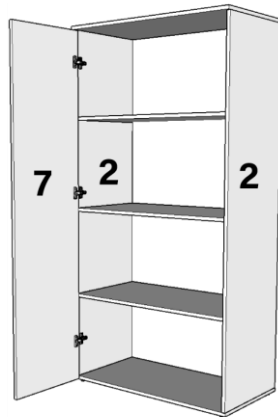
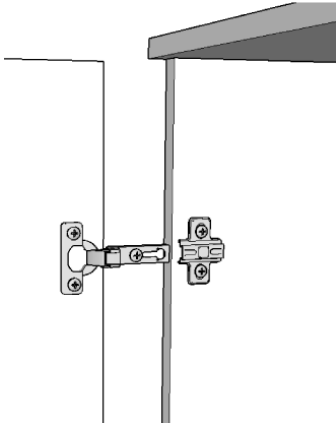

FIXAR PORTAS "7" E "8".

USE DOBRADIÇA CALÇO "D3" + PARAFUSO 3,5X14 "P1" NAS LATERAIS "2" E DOBRADIÇA BRAÇO CURVO "D2" + PARAFUSO 3,5X14 "P1" NAS PORTAS "7" E "8".

PASSO 06

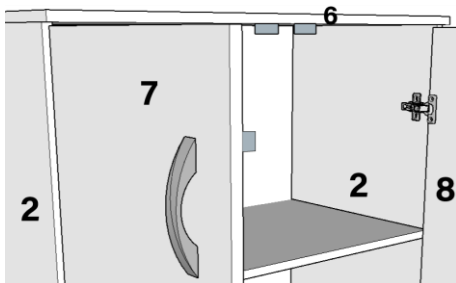

FIXAR PUXADOR "F1" NAS PORTAS "7" E "8" USANDO PARAFUSO 4,5X25 "P2".

FIXAR BATENTE L "B2" NO TAMPO "6" USANDO PARAFUSO 3,5X14 "P1".

PASSO 07

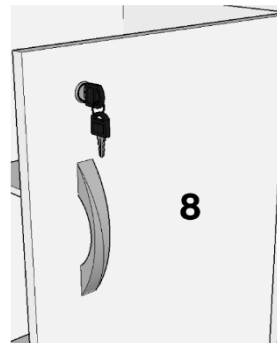

FIXAR FECHADURA "F2" + DISTANCIADOR "D1" NA PORTA "8" USANDO PARAFUSO 3,5X14 "P1".

IMAGEM PRODUTO MONTADO

i

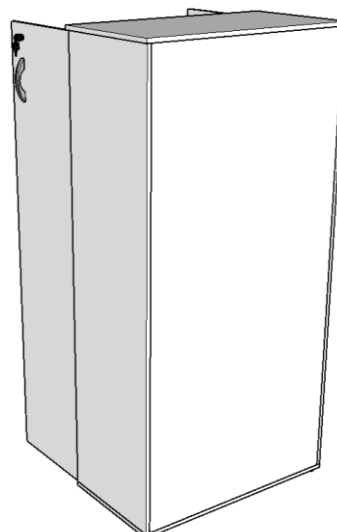
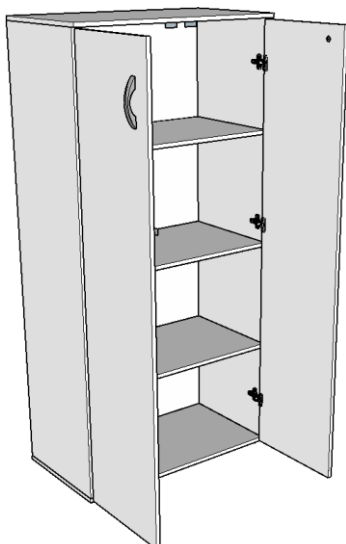

# MANUAL DE MONTAGEM ARMÁRIO BAIXO 2P 30MM F.15MM

## ACESSÓRIOS

A1	ADESIVO TAPA FURO		12
B1	BUCHA M6X10		4
B2	BATENTE L DE FECHADURA		2
B3	BATENTE DE PORTA		1
C1	CAVILHA DE MADEIRA 6X30		16
C2	CAVILHA METALICA 6X8		4
D1	DISTANCIADOR DE FECHADURA		1
D2	DOBRADIÇA BRAÇO CURVO		4
D3	DOBRADIÇA CALÇO		4
F1	PUXADOR		2
F2	FECHADURA		1
M1	TAMBOR MINIFIX		8
M2	HASTE MINIFIX ROSCA SOBERBA		8
P1	PARAFUSO GERAL 3,5X14		30
P2	PARAFUSO 4,5X25		4
S1	SAPATA M6X14		4

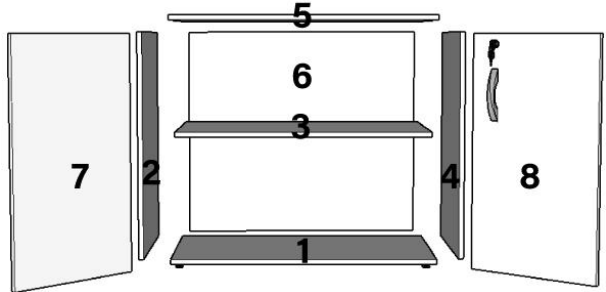
VISTA EXPLODIDA	PEÇAS	DESCRIÇÃO DA PEÇA	QUANTIDADE
	1	BASE	1
	2	LATERAL	1
	3	PRATELEIRA	1
	4	LATERAL	1
	5	TAMPO	1
	6	COSTAS	1
	7	PORTA ESQUERDA	1
	8	PORTA DIREITA	1

### PASSO 01

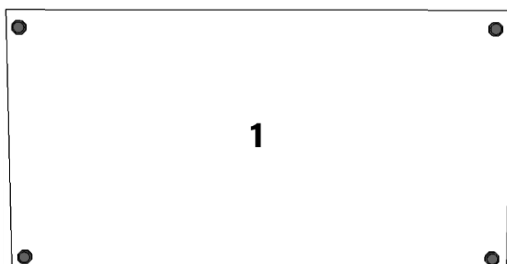

NAS 4 EXTREMIDADES FIXE A BUCHA DE SAPATA "B1" E DEPOIS APERTE A SAPATA "S1".

### PASSO 02

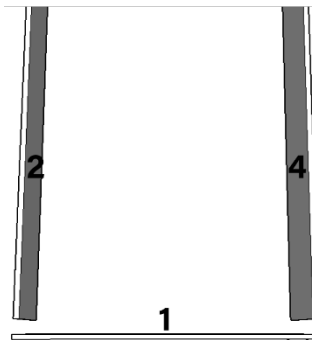

FIXAR LATERAIS "2" E "4" NA BASE "1". USE CAVILHA "C1" + HASTE "M2" NA BASE "1".

JÁ NAS LATERAIS "2" E "4", ENCAIXE O TAMBOR MINIFIX "M1" E APERTE-O.

## PASSO 03

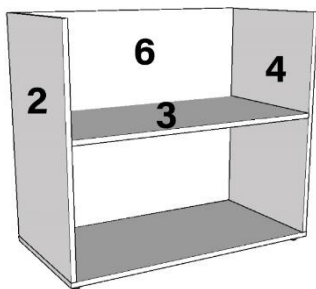

FIXAR COSTAS "6" E LOGO APÓS A PRATELEIRA "3" NAS LATERAIS "2" E "4".

USE CAVILHA "C1" + HASTE MINIFIX "M2" NAS LATERAIS "2, 4" E TAMBOR MINIFIX "M1" NAS COSTAS "6".

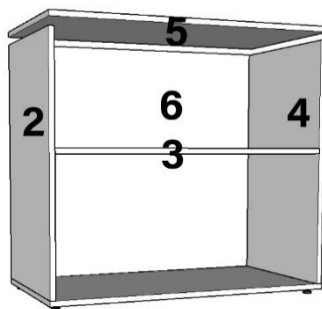

FIXAR TAMPO "5" NAS LATERAIS "2" E "4".

USE CAVILHA "C1" + HASTE MINIFIX "M2" NO TAMPO "5" E TAMBOR "M1" NAS LATERAIS "2,4".

## PASSO 05

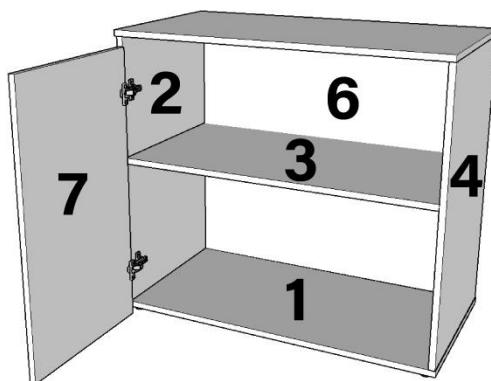
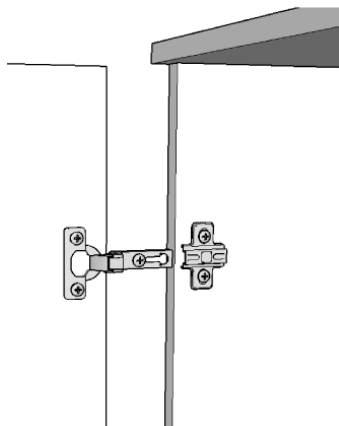

FIXAR PORTAS "7" E "8".

USE DOBRADIÇA CALÇO "D3" + PARAFUSO 3,5X14 "P1" NAS LATERAIS "2,4" E DOBRADIÇA BRAÇO CURVO "D2" + PARAFUSO 3,5X14 "P1" NAS PORTAS "7,8".

## PASSO 06

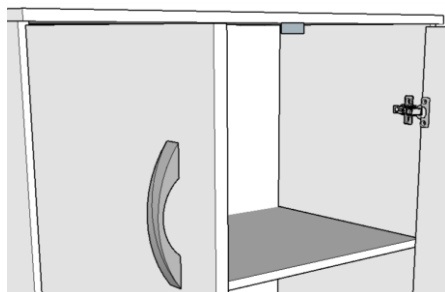

FIXAR PUXADOR "F1" NAS PORTAS "7,8" USANDO PARAFUSO 4,5X25 "P2".

FIXAR BATENTE L "B2" NA PRATELEIRA CENTRAL "3" USANDO PARAFUSO 3,5X14 "P1".

## PASSO 07

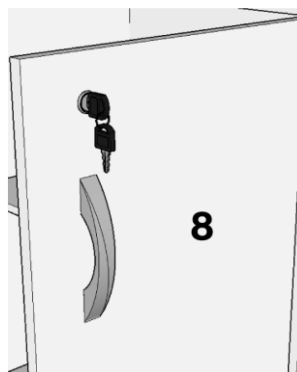

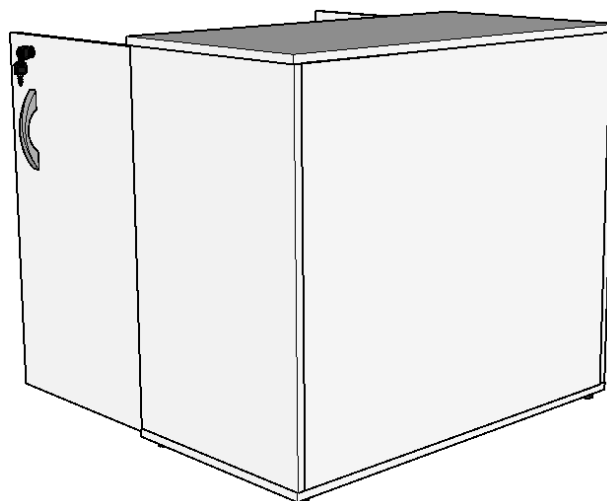
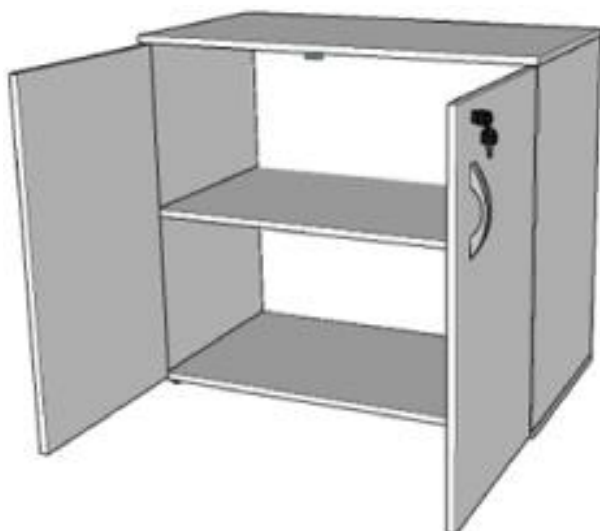

FIXAR FECHADURA "F2" + DISTANCIADOR "D1" NA PORTA "8" USANDO PARAFUSO 3,5X14 "P1".

## IMAGEM ARMARIO ALTO 2 PORTAS COM FUNDO DE 15MM MONTADO

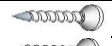

MANUAL DE MONTAGEM GAVETEIRO VOLANTE 4 GAVETAS

ACESSÓRIOS

A1	ADESIVO TAPA FURO		8
B2	BATENTE L P/FECHADURA		1
C1	CAVILHA DE MADEIRA 6X30		20
C6	CORREDIÇA TELESCÓPICA 350MM		4
D1	DISTANCIADOR DE FECHADURA		1
F1	PUXADOR		4
F2	FECHADURA		1
M1	TAMBOR MINIFIX		12
M2	HASTE MINIFIX ROSCA SOBERBA		12
P1	PARAFUSO 3,5X14		52
P2	PARAFUSO 4,5X25		8
P3	PARAFUSO CABEÇA CHATA 4X40		20
R1	RODÍZIO		4

VISTA EXPLODIDA

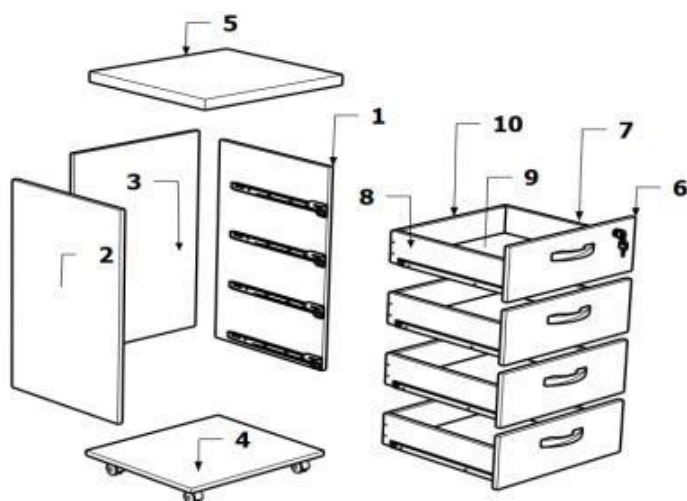

PEÇA	DESCRIÇÃO DA PEÇA	QUANTIDADE
1	LATERAL DIREITA GAVETEIRO	1
2	LATERAL ESQUERDA GAVETEIRO	1
3	COSTAS GAVETEIRO	1
4	BASE GAVETEIRO	1
5	TAMPO GAVETEIRO	1
6	FRENTE DE GAVETA	4
7	LATERAL DIREITA GAVETA	4
8	LATERAL ESQUERDA GAVETA	4
9	EUCAPLAC	4
10	FUNDO DE GAVETA	4

PASSO 01

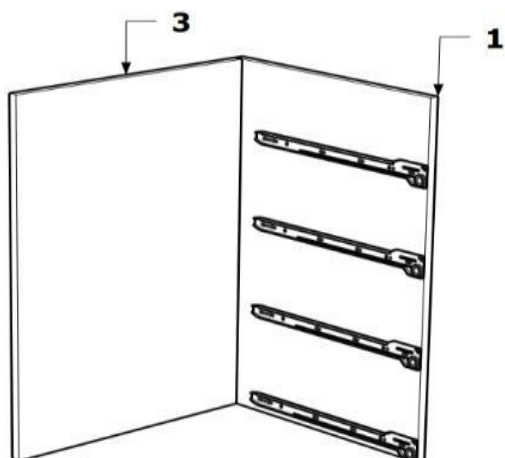

FIXAR CORREDIÇA "C6" NAS LATERAIS "1" DO GAVETEIRO VOLANTE UTILIZANDO PARAFUSOS "P1".

FIXAR LATERAL "1" NAS COSTAS "3" UTILIZANDO CAVILHAS "B1".

REPETIR O PROCESSO COM A LATERAL "2".

PASSO 02

FIXAR RODÍZIOS "R1" NA BASE "4" UTILIZANDO PARAFUSOS "P1".

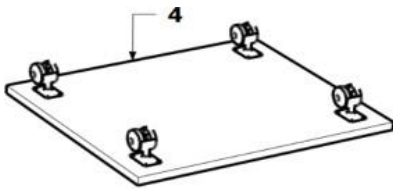

PASSO 03

FIXAR BASE "4" NAS LATERAIS "1, 2" UTILIZANDO CAVILHAS "C1" + PARAFUSOS "P3".

FIXAR TAMPO "5" NAS LATERAIS "1, 2" UTILIZANDO CAVILHAS "C1" + HASTE "M2" NO TAMPO.

USE TAMBORES "M1" NAS LATERAIS "1, 2".

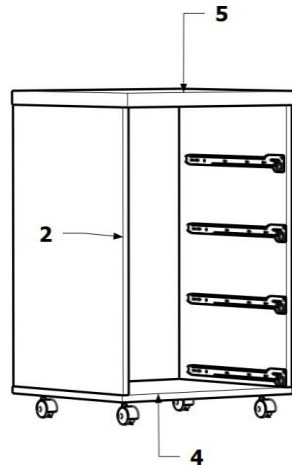

PASSO 04

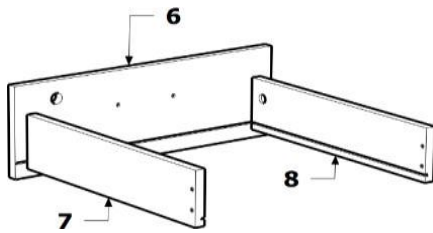

FIXAR LATERAIS "7, 8" NA FRENTE "6".

UTILIZE CAVILHA "C1" + HASTES "M2" NA FRENTE DA GAVETA E TAMBORES "M1" NAS LATERAIS.

PASSO 05

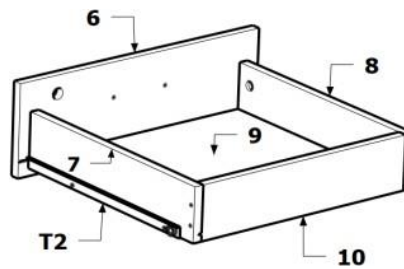

ENCAIXAR EUCAPLAC "9" AO RESTANTE DA GAVETA.

FIXAR FUNDO "10" NAS LATERAIS "7, 8" UTILIZANDO PARAFUSOS "P3".

FIXAR CORREDIÇA "C6" NAS LATERAIS "7, 8" UTILIZANDO PARAFUSOS "P1".

PASSO 06

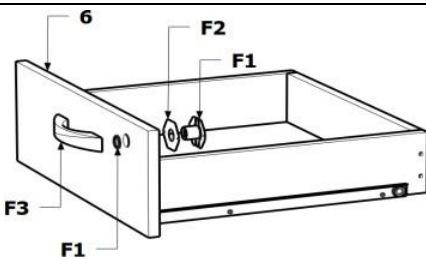

INSERIR DISTANCIADOR "D1" + FECHADURA "F2" NA PARTE INTERNA DA FRENTE "6".

INSERIR ANEL FRONTAL DA FECHADURA "F2" NA PARTE EXTERNA DA FRENTE "6".

FIXAR FECHADURA UTILIZANDO PARAFUSOS "P1".

FIXAR PUXADOR "F1" UTILIZANDO PARAFUSOS "P2".

PASSO 07

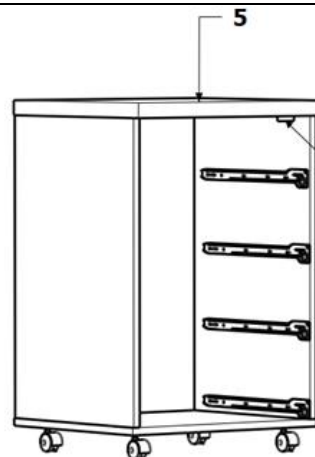

FIXAR BATENTE EM L P/ FECHADURA "B2" NO TAMPO "5" UTILIZANDO PARAFUSOS "P1".





POR FIM COLE OS ADESIVOS TAPA FUROS "A1" E ENCAIXE AS GAVETAS.

IMAGEM PRODUTO MONTADO



## MANUAL DE MONTAGEM MESA RETA 30MM PE PAINEL

### ACESSÓRIOS

CÓDIGO	DESCRIÇÃO	IMAGEM	QUANTIDADE
A1	ADESIVO TAPA FURO		12
B1	BUCHA M6X10		4
C8	CANTONEIRA EM L 13X13		2
M1	TAMBOR MINIFIX		8
M2	HASTE MINIFIX ROSCA SOBERBA		8
P1	PARAFUSO 3,5X14		4
S1	SAPATA M6X14		4

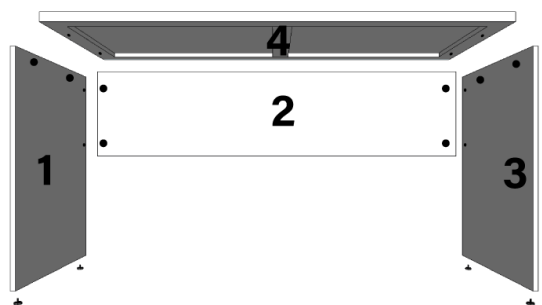
VISTA EXPLODIDA	PEÇA	DESCRIÇÃO DA PEÇA	QUANTIDADE
	1	PE PAINEL	1
	2	SAIA	1
	3	PE PAINEL	1
	4	TAMPO MESA	1

### PASSO 01



FIXAR A BUCHA DA SAPATA "B1" NOS PÉS "1 E 3" E DEPOIS APERTAR A SAPATA "S1".

### PASSO 02

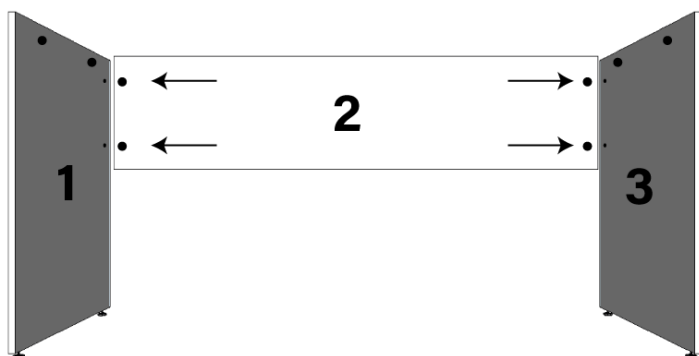

FIXAR SAIA "2" NOS PÉS "1" E "3".

USE HASTE MINIFIX "M2" NOS PÉS "1 E 3", DEPOIS FIXE O TAMBOR MINIFIX "M1" NA SAIA "2" E APORTE AMBOS OS LADOS.

PASSO 03

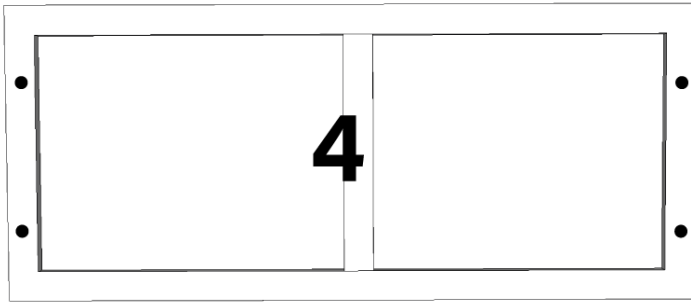

OBSERVE QUE O TAMPO "4" APRESENTA FUROS NAS EXTREMIDADES.

FIXE HASTE MINIFIX "M2" NO TAMPO "4" USANDO CHAVE PHILLIPS.

PASSO 04

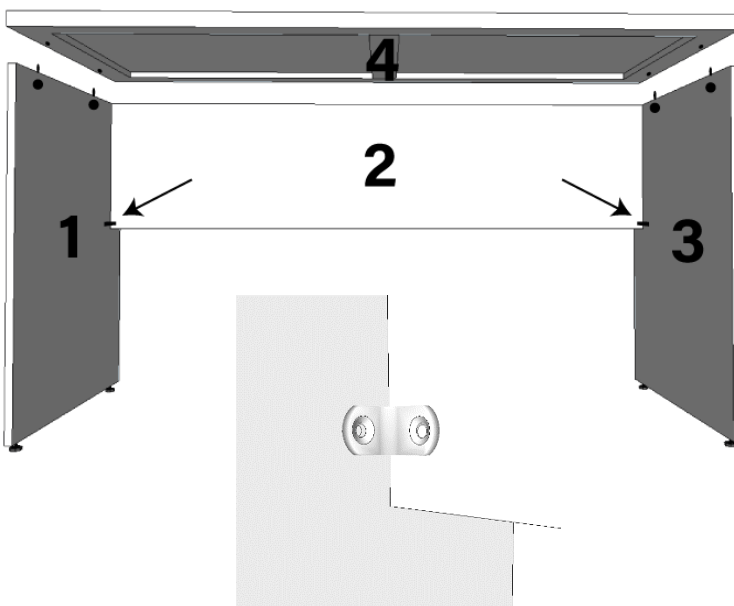

POSICIONE O TAMPO "4" SOBRE OS PÉS "1 E 3", DE ACORDO COM QUE AS HASTES MINIFIX "M2" DO TAMPO ENCAIXEM NOS FUROS DOS PÉS "1" E "3".

OBSERVE QUE NA PARTE INTERNA DOS PÉS HÁ DOIS FUROS PARA ENCAIXAR O TAMBOR MINIFIX "M1".

APÓS, FIXE A CANTONEIRA EM L "C8". CONFORME IMAGEM E SETAS, ENTRE A SAIA "2" E OS PÉS "1" E "3" USE PARAFUSO 3,5X14 "P1" PARA FIXAR.

PARA FINALIZAR, COLE OS ADESIVOS TAPA-FUROS "A1" SOBRE OS DEVIDOS LUGARES.

IMAGEM PRODUTO MONTADO

IMAGEM DE FRENTE

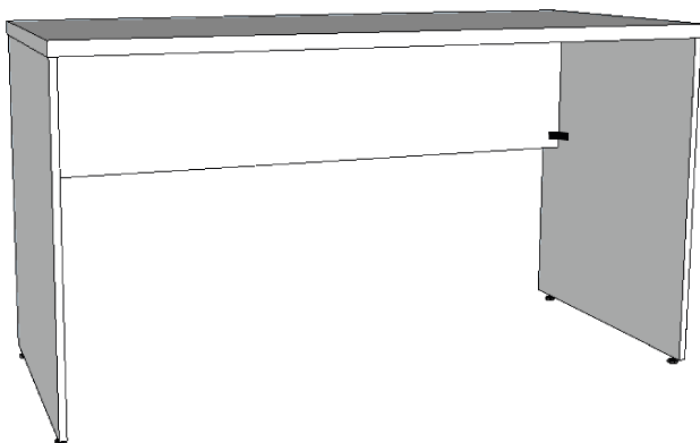

IMAGEM COSTAS

