

MANUAL DO PRODUTO

Manual del Producto
User's Guide



Rack Sampa

Rack Sampa / Sampa Rack

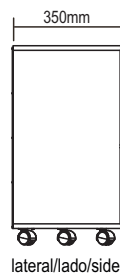
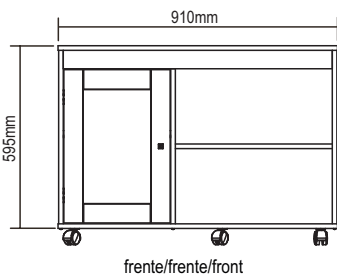
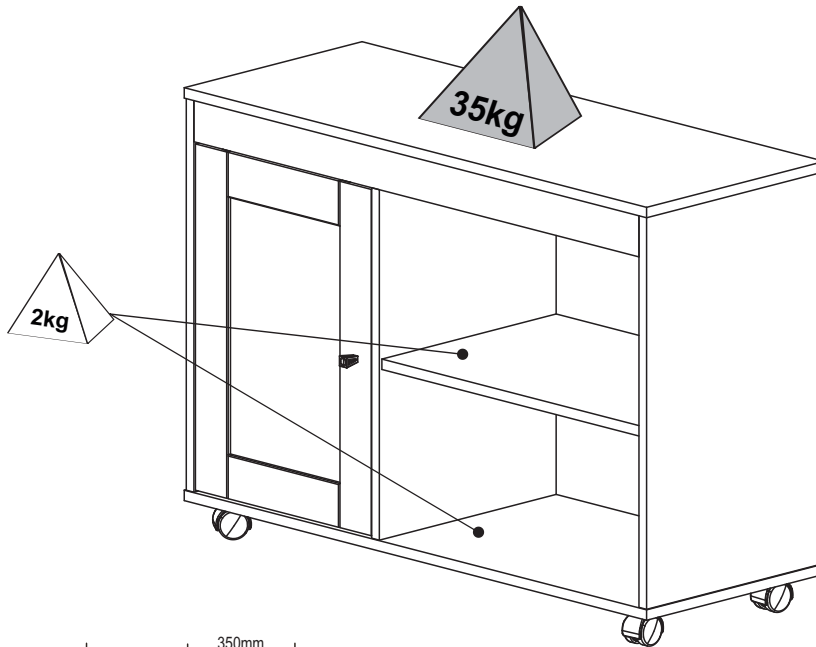

Conservação e Limpeza - Conservación y Limpieza - Conservation and Cleaning

Não expor o produto ao sol, altas temperaturas e umidade. Não arrastar objetos sobre a superfície do móvel (ex.: TV, equipamentos eletrônicos, objetos decorativos...). Manter em local seco e arejado. Para a limpeza, utilizar um pano seco e macio. Não é necessário o uso de materiais abrasivos ou álcool.

No exponga el producto a la luz solar, las altas temperaturas y la humedad. No arrastre los objetos en la superficie de la unidad (por ejemplo, TV, equipos electrónicos, objetos de decoración ...). Mantener en un lugar fresco y seco. Para la limpieza, utilizar un paño seco y suave. El uso de materiales abrasivos o del alcohol no es necesario.

Do not expose the product to sunlight, high temperatures and humidity. Do not drag objects across the surface of the unit (TV, electronic equipments, decorative objects ...). Keep it in a cool and dry place. For cleaning, use a dry and soft cloth. Do not use abrasive materials or alcohol.

Garantia

Este certificado de Garantia é uma vantagem adicional oferecida ao consumidor, porém para que o mesmo tenha validade é imprescindível que seja apresentada a NOTA FISCAL de compra do produto.

Com este produto, a Artely tem como objetivo atender plenamente o proprietário-consumidor, proporcionando a garantia na forma aqui estabelecida, pelo período de três meses a partir da data da nota fiscal de compra. A Artely restringe a sua responsabilidade à substituição gratuita das peças defeituosas, em caso de defeitos ou avarias devidamente constatados como sendo de fabricação, durante a vigência desta garantia.

A Artely declara a garantia nula e sem efeito se o produto for alterado, adulterado, molhado ou consertado e ainda pela prática de montagem inadequada ou mau uso. Também será considerada nula em casos de força maior, como aqueles causados por agentes da Natureza (chuvas, incêndios, excesso de umidade, cupins,...) e eventos externos como objetos arrastados sobre a superfície do móvel (ex.: TV, DVD, aparelho de som, objetos decorativos...).

Para exercer seus direitos de comprador é importante que antes de montar seu produto você leia com atenção as instruções de cada passo do manual de montagem que acompanha o móvel.

Caso o produto não esteja em conformidade, entre em contato com a loja onde efetuou a compra e faça sua reclamação, apontando os defeitos técnicos observados. Para agilizar o seu atendimento, tenha sempre em mãos o manual de montagem com os respectivos números das peças defeituosas, conforme descritas no manual.

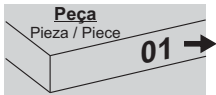

- O número na borda da peça corresponde ao manual.
- Para retirada do número usar Lustra-Móveis, Alcool em Gel ou Borracha.
- El número en el borde de la pieza coincide con el manual.
- Use una goma de borrar blanca, alcohol en gel o lustrador para muebles para eliminar los números.
- The number on the edge of the piece matches the manual.
- Use a White eraser, Alcohol Gel or Furniture Polish to remove the numbers.

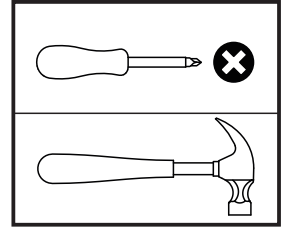

Ferramentas não fornecidas

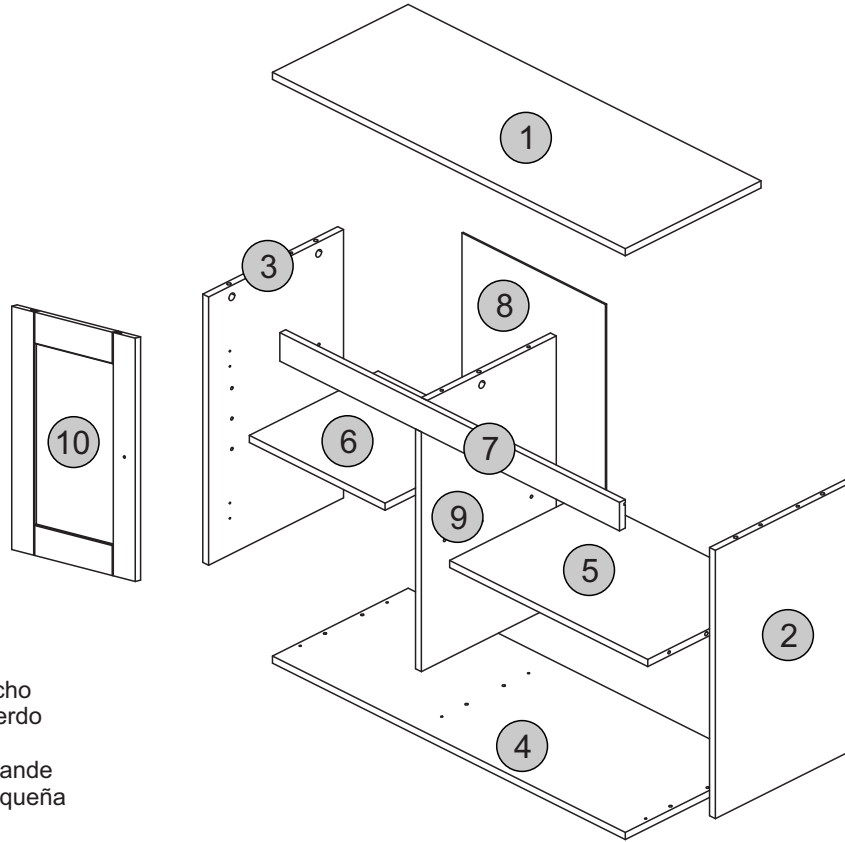

Description

Descripción









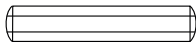

- 1-Top
- 2-Right side
- 3-Left side
- 4-Base
- 5-Large Shelf
- 6-Small Shelf
- 7-Platter
- 8-Rear
- 9-Division
- 10-Door

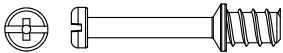
- 1-Tapa
- 2-Lado derecho
- 3-Lado izquierdo
- 4-Base
- 5-Estante Grande
- 6-Estante pequeña
- 7-Travesaño
- 8-Trasero
- 9-División
- 10-Puerta

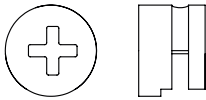
Descrição	Material	Código Carvalho	Código Menta	Código O ffWhite	Código Pinho	Código Off / Palha	Código Menta/ Palha	Qtd
1-Tampo (910x350x15mm)	MDP	079823			079824			1
2-Lateral Direita (565x348x15mm)	MDP	079623			079825			1
3-Lateral Esquerda (565x348x15mm)	MDP		079826	079827				1
4-Base (910x350x15mm)	MDP	079828		079829				1
5-Prateleira Maior (511x343x15mm)	MDP	079830		079831				1
6-Prateleira Menor (350x332x15mm)	MDP		079832	079833				1
7-Travessa (876x60x15mm)	MDP		079834	079835				1
8-Traseiro (590x370x3mm)	MDF	079836			079837			2
9-Divisão (565x348x15mm)	MDF	079838			079839			4
10-Porta (499x346x15mm)	-	0						
-	-	0						
-	-	0						
-	-							
-	-							
-	-	0						

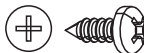
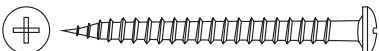
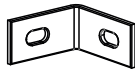
Lista de Materiais

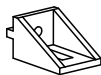
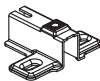
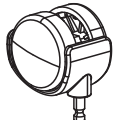
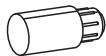
Lista de Materiales/ Hardware List

A		Cavilha / Tarugo / Dowel Ø6x30mm Madeira	16	J		Puxador / Arrancador / Puller	01
B		Minifix / Minifix / Minifix Ø7x30mm Metal	07	K		Prego / Clavo / Nail 8x8 Metal	14
C		Tambor / Tambor / Minifix Cam Ø15x12mm Metal	07	L		Parafuso / Tornillo / Screw / Ø3,5x25mm CP Metal - Cabeça Philips	01
D		Tapa furo adesivo / Adhesivo / Hole Cover Ø18mm Papel	05	M		Parafuso Ø4,0x14mm CC Metal - Cabeça Philips	18
E		Parafuso / Tornillo / Screw / Ø3,5x40mm CP Metal - Cabeça Philips	06	N		Cantoneira / Esquina / Corner	02
F		Dobradiça / Bisagra / Hinge / Metal - 26mm	02	O		Suporte Angular Soporte angular Angular Support	03
G		Calço / Cuña / Chock /	02	P		Rodizio Rotación Rotation	05
H		Pino / Alfiler / Pin Ø6x18	04	Q		Bucha / Cojinete / Bushing	05
				R		Produto Moldado / Silicona / Silicone 8mm	02

DICAS PARA FIXAR MINIFIX

TIP TO FASTEN THE MINIFIX
PISTA PARA ARREGLAR EL MINIFIX

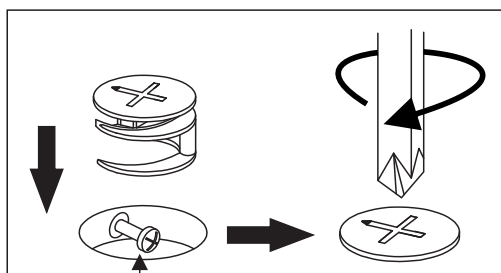

Cabeça do parafuso precisa estar no centro

La cabeza del tornillo debe estar en el centro

Screw head has to be in the center

Parafuso Minifix

Tornillo minifix/Minifix screw

Fixe o parafuso até o ressalto encostar na superfície da peça (veja o exemplo abaixo).

Tighten the screw until its overhang part lean on the piece surface (see the example below).

Fije el tornillo hasta que su parte sobresaliente toque la superficie de la pieza (vea el ejemplo abajo).

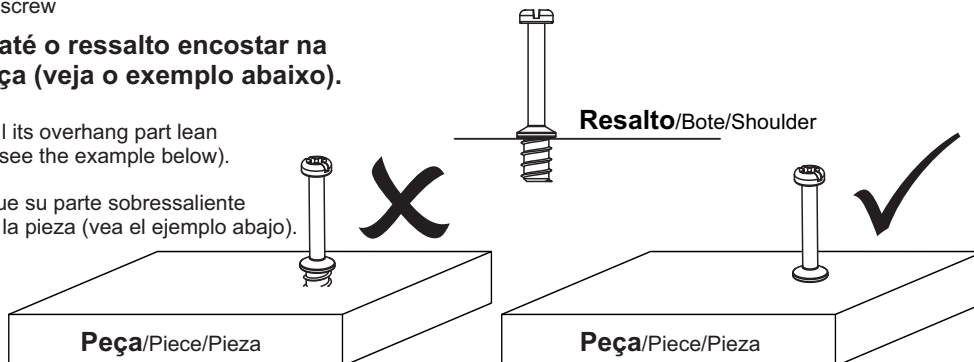

Lista de cores dos Materiais

Cor Produto	D	P
CAR/MEN	CAR/MEN	OFF
CAR/OFF	CAR/OFF	OFF
PIN/OFF	PIN/OFF	OFF
Qtd	16/4	20

Legenda de cores

OFF - Off White	MEN - Menta
CAR - Carvalho	PIN - Pinho
BR - Branco	PR - Preto

Passo 1

Paso/Step

PEÇA
Pieza/Piece

2 - LATERAL DIREITA x1

FERRAGEM
Herraje/Hardware

B  01

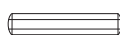
A  04

FERRAMENTA
Herramienta/Tool

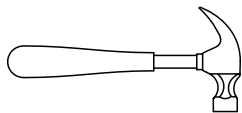
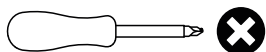

Detalhe 2

Detalhe 1

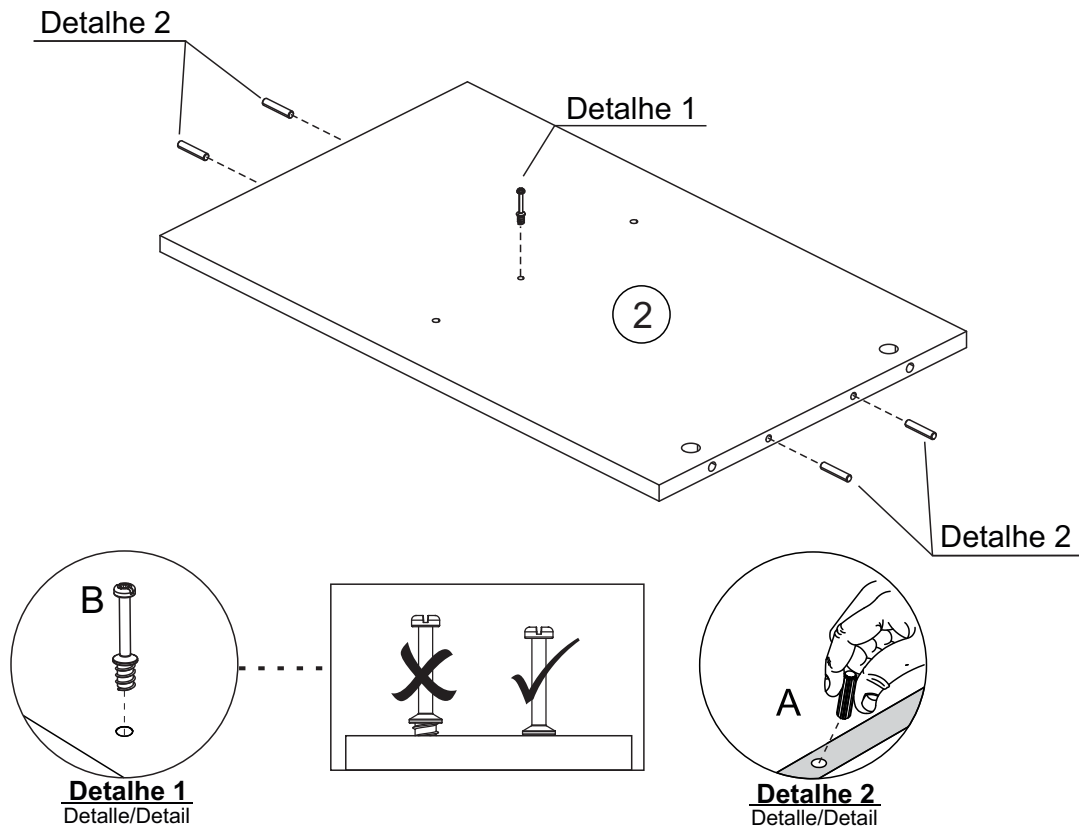

Detalhe 1
Detalle/Detail

Detalhe 2
Detalle/Detail

Passo 2

Paso/Step

PEÇA
Pieza/Piece

3 - LATERAL ESQUERDA x1

FERRAGEM
Herraje/Hardware

A  04

H  02

G  02

M  04

FERRAMENTA
Herramienta/Tool

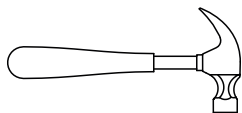
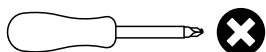

Detalhe 2

Detalhe 3

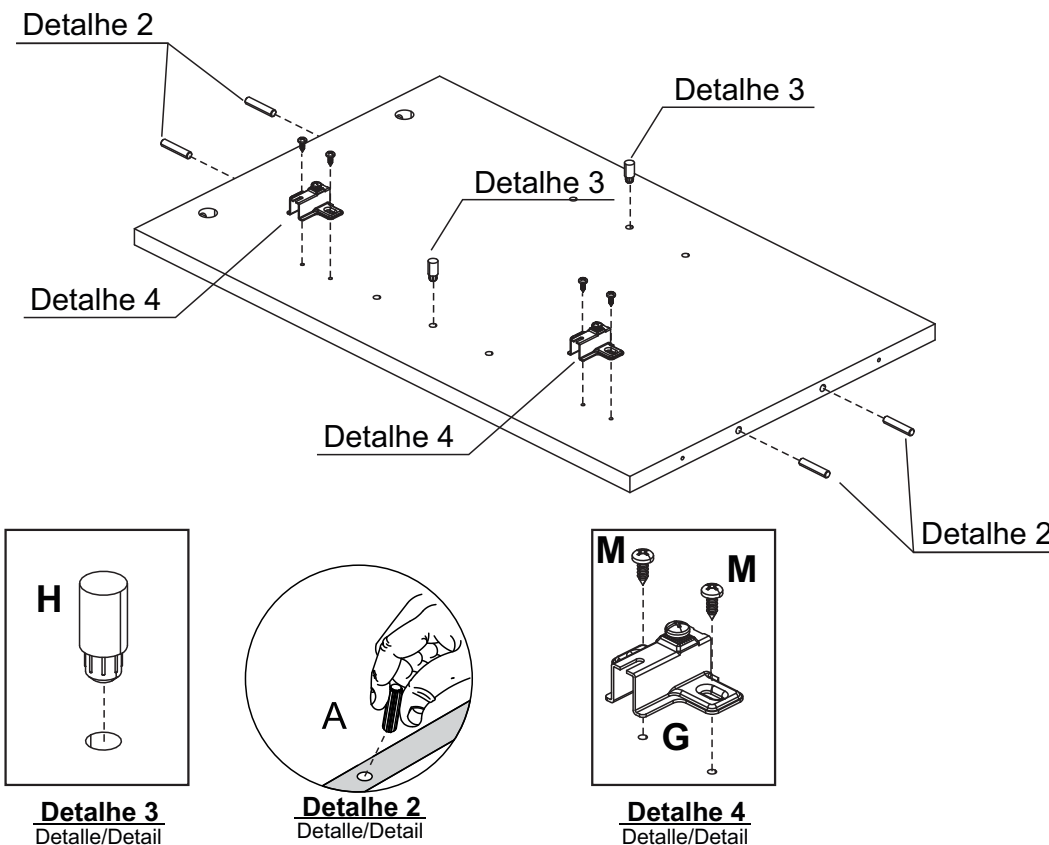

Detalhe 3
Detalle/Detail

Detalhe 2
Detalle/Detail

Detalhe 4
Detalle/Detail

Passo 3

Paso/Step

PEÇA
Pieza/Piece

9 - Divisão x1

FERRAGEM
Herraje/Hardware

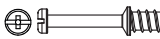
B  01

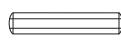
A  04

FERRAMENTA
Herramienta/Tool

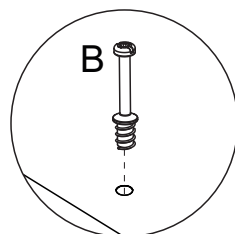
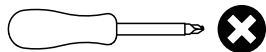

Detalhe 1
Detalle/Detail

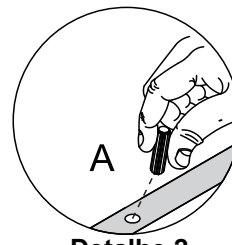
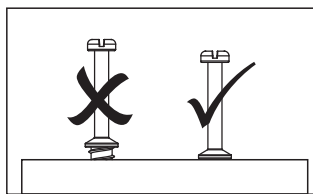

Detalhe 2
Detalle/Detail

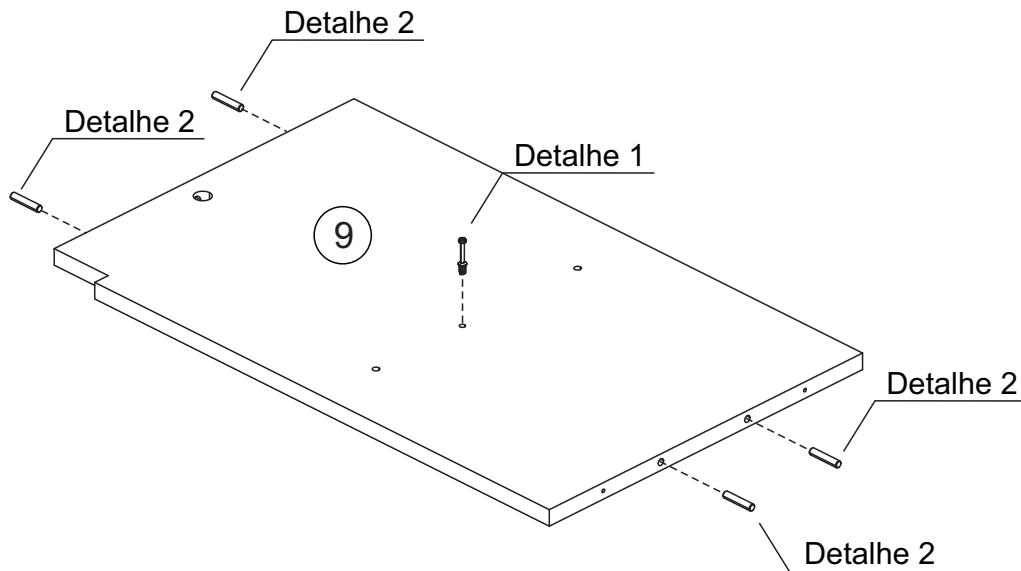

Passo 4

Paso/Step

PEÇA
Pieza/Piece

9 - Divisão x1

FERRAMENTA
Herramienta/Tool

H  02

FERRAMENTA
Herramienta/Tool

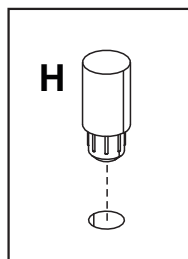
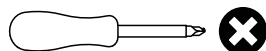

Detalhe 3
Detalle/Detail

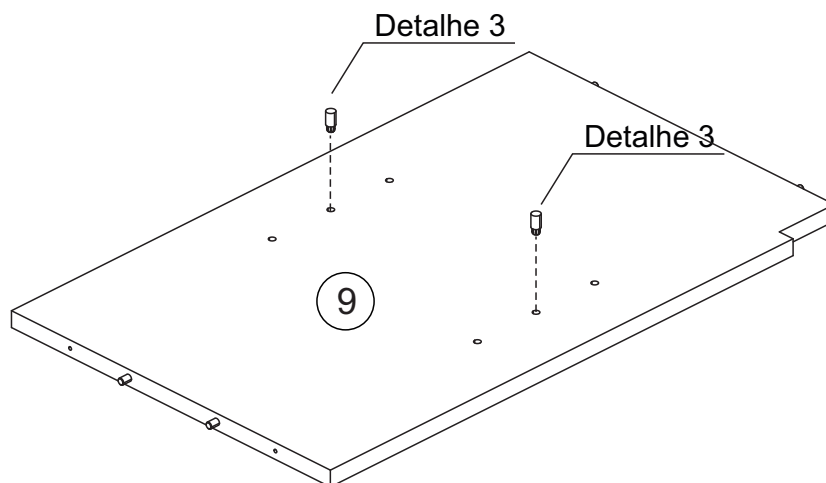

Passo 5

Paso/Step

PEÇA
Pieza/Piece

1 - TAMPO x1

FERRAGEM
Herraje/Hardware

B  05

FERRAMENTA
Herramienta/Tool

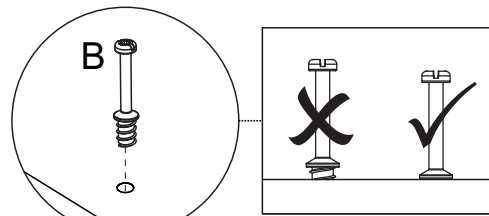
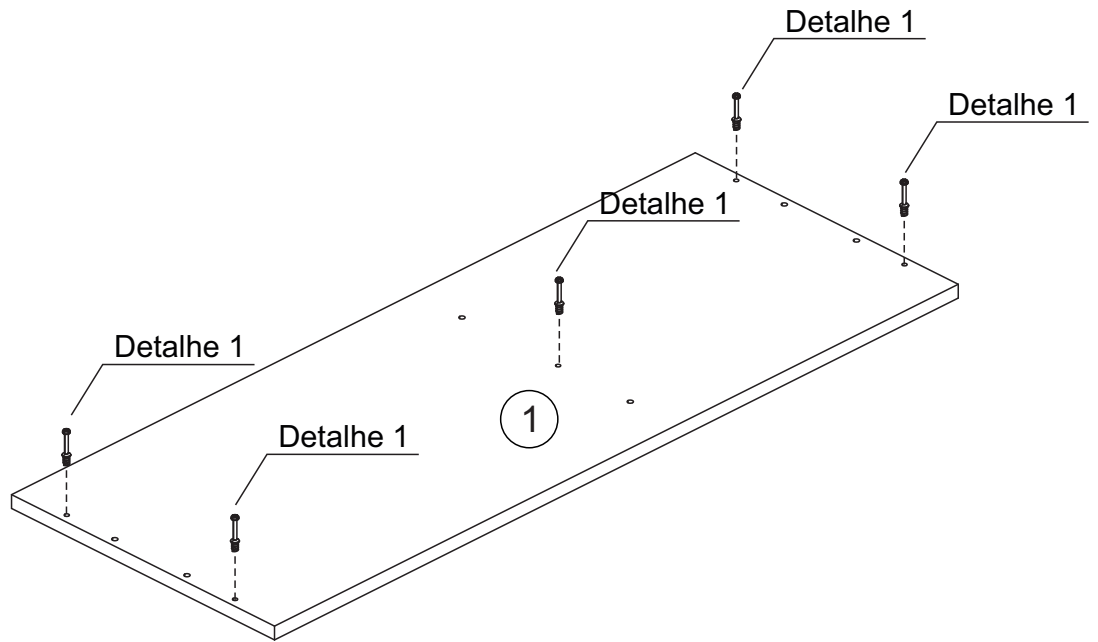
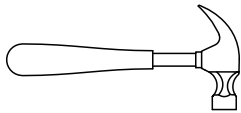
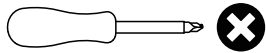

Detalhe 1
Detalle/Detail

Passo 6

Paso/Step

PEÇA
Pieza/Piece

9 - DIVISÃO x1

2 - LATERAL DIREITA x1

5 - PRATELEIRA GRANDE x1

FERRAGEM
Herraje/Hardware

C   02

D  x2

FERRAMENTA
Herramienta/Tool

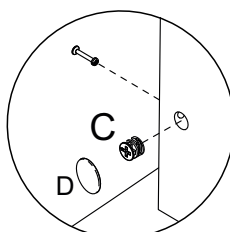
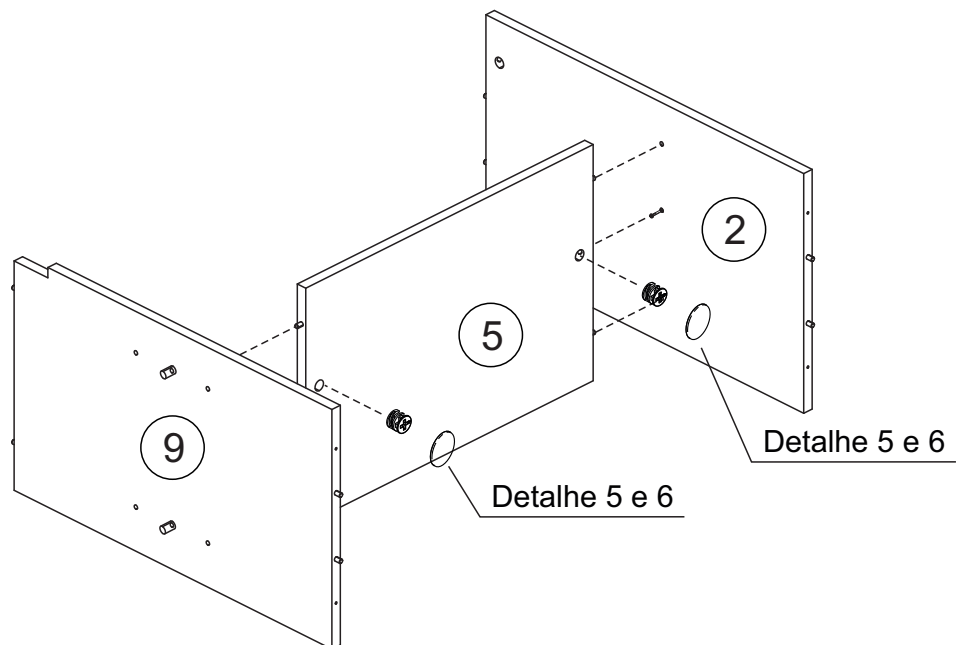
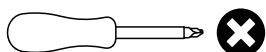

Detalhe 5
Detalle/Detail

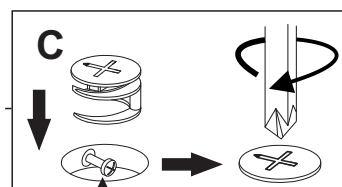

Cabeça do parafuso precisa estar no centro
La cabeza del tornillo debe estar en el centro
Screw head has to be in the center

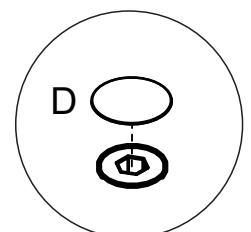

Detalhe 6
Detalle/Detalle

Passo 7

Paso/Step

PEÇA

Pieza/Piece

3 - LATERAL ESQUERDO x1

4 - BASE x1

FERRAGEM

Herraje/Hardware

E  06

FERRAMENTA

Herramienta/Tool

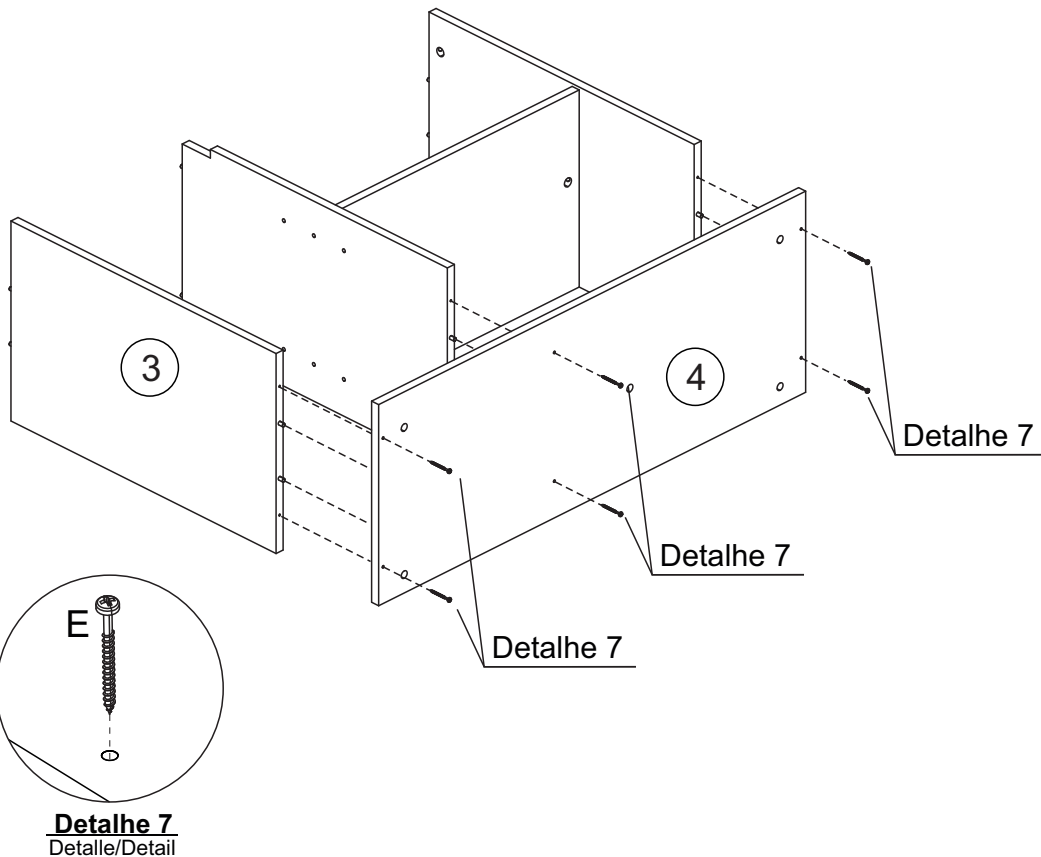
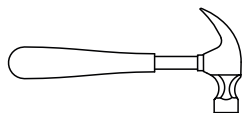
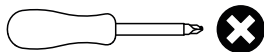

Passo 8

Paso/Step

PEÇA

Pieza/Piece

6 - PRATELEIRA x1

FERRAGEM

Herraje/Hardware

M  07

N  02

O  03

FERRAMENTA

Herramienta/Tool

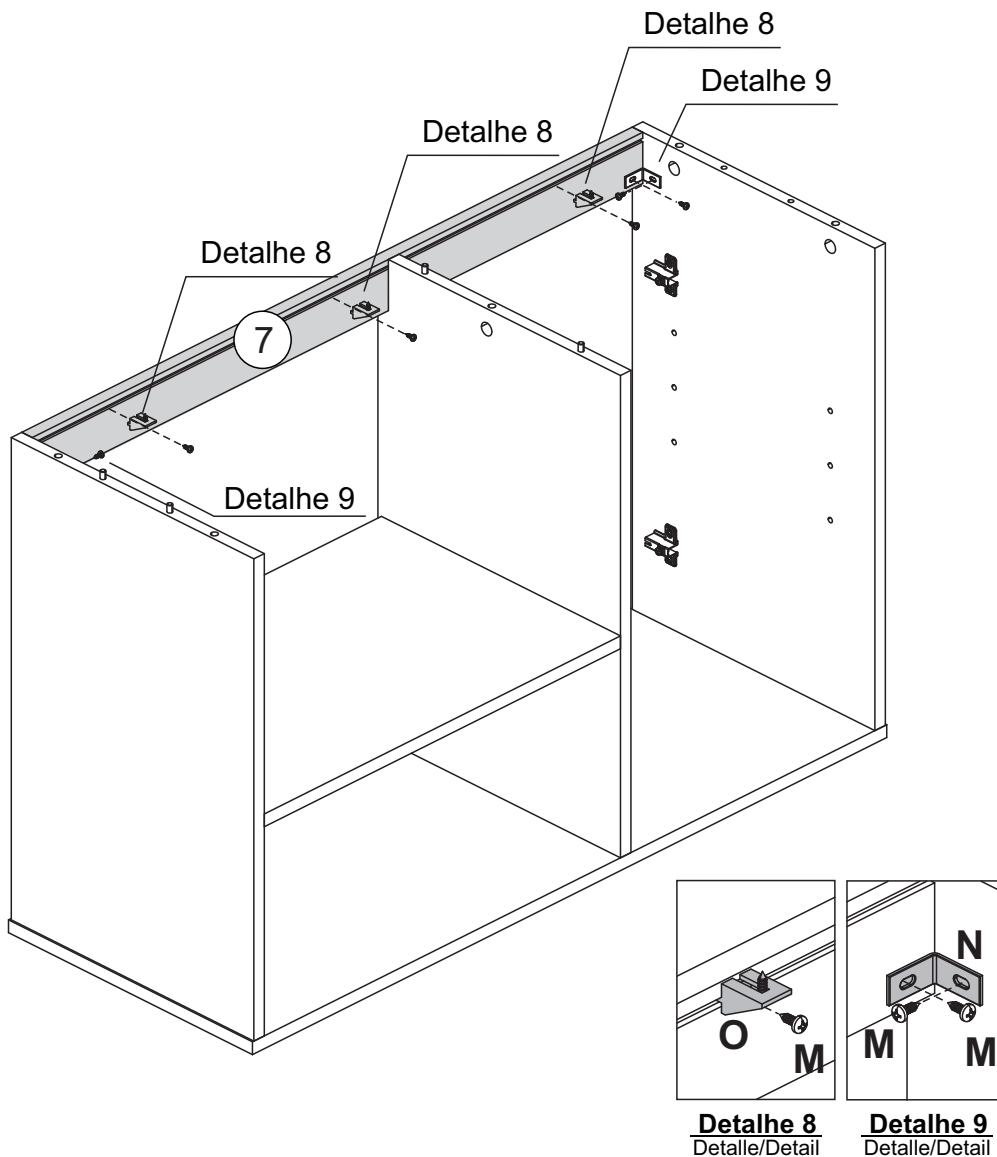
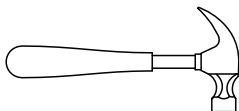

Passo 9



Paso/Step

PEÇA Pieza/Piece

1 - TAMPO x1

FERRAGEM Herraje/Hardware

M  03

C   05

D  x5

FERRAMENTA Herramienta/Tool

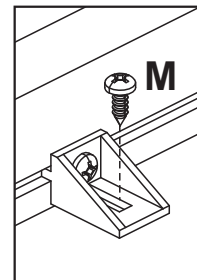
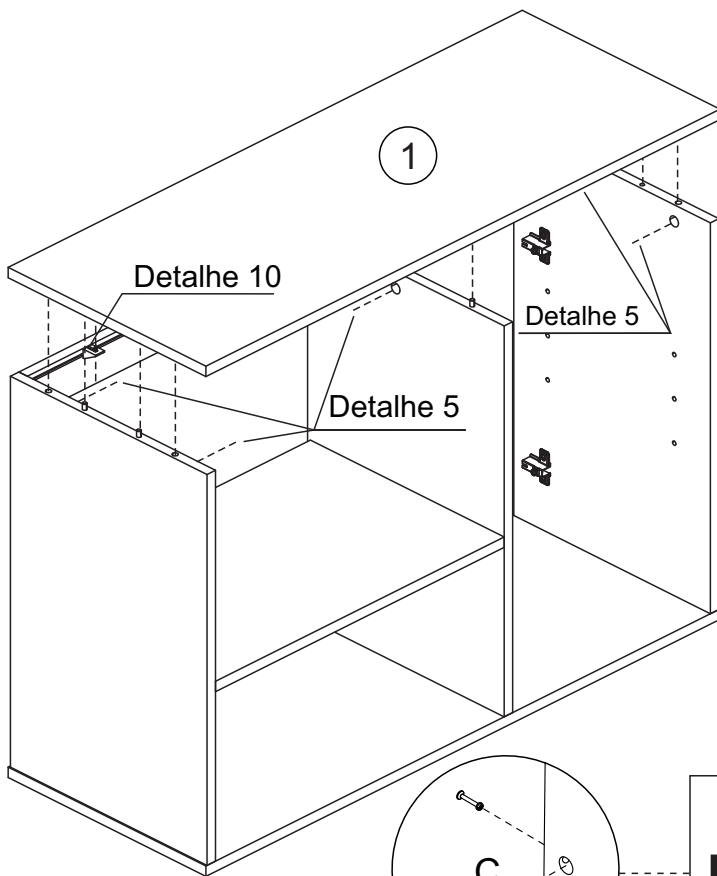
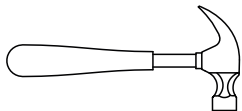
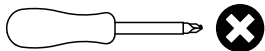

Detalhe 10
Detalle/Detail

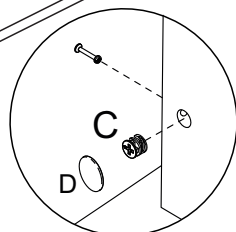

Detalhe 5
Detalle/Detail

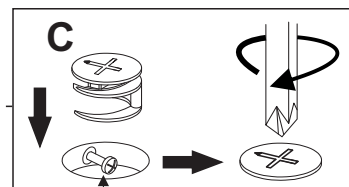

Cabeça do parafuso precisa estar no centro
La cabeza del tornillo debe estar en el centro
Screw head has to be in the center

Passo 10

Paso/Step

PEÇA Pieza/Piece

8 - TRASEIRO x1

FERRAGEM Herraje/Hardware

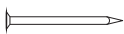
K  14

FERRAMENTA Tool/Herramienta

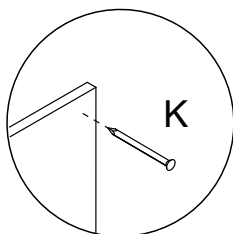
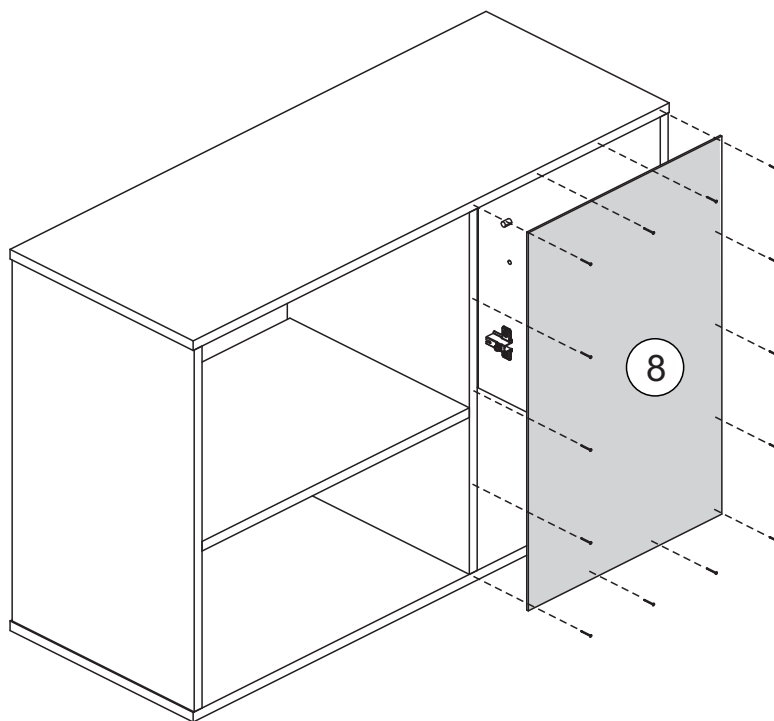
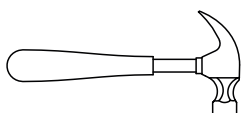

Detalhe 10
Detalle/Detail

Passo 11

Paso/Step

PEÇA

Pieza/Piece

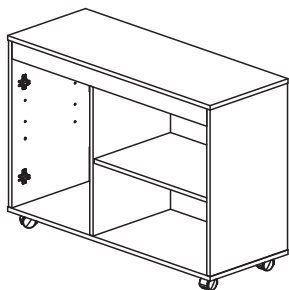

FERRAGEM

Herraje/Hardware

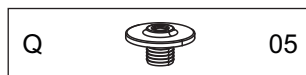
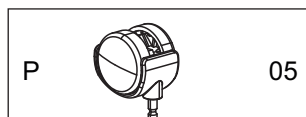

FERRAMENTA

Herramienta/Tool

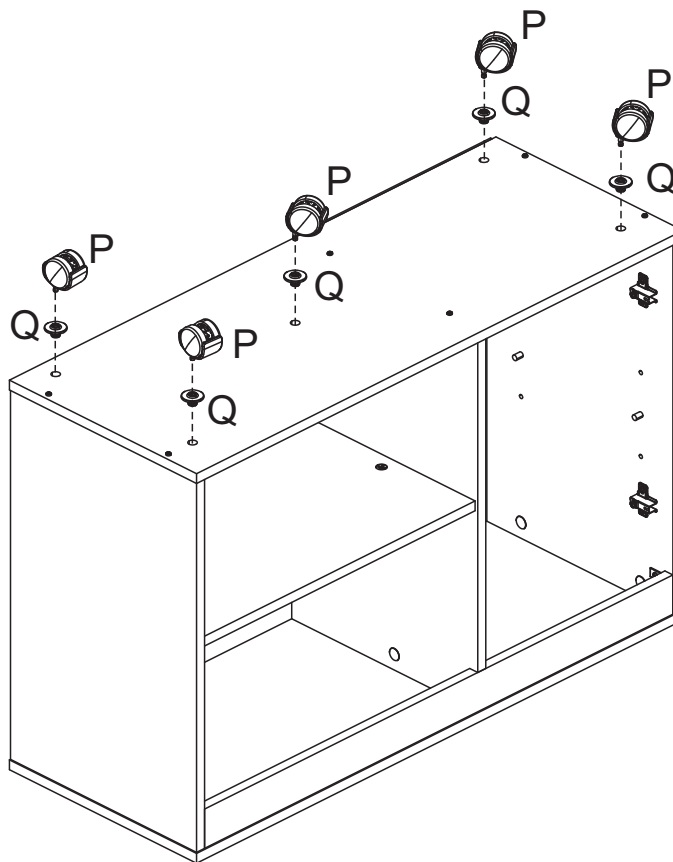
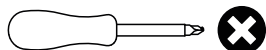

Passo 12

Paso/Step

PEÇA

Pieza/Piece

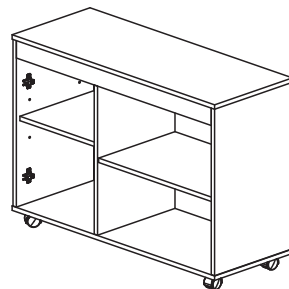

6 - PRATELEIRA x1

FERRAGEM
Herraje/Hardware

FERRAMENTA
Herramienta/Tool

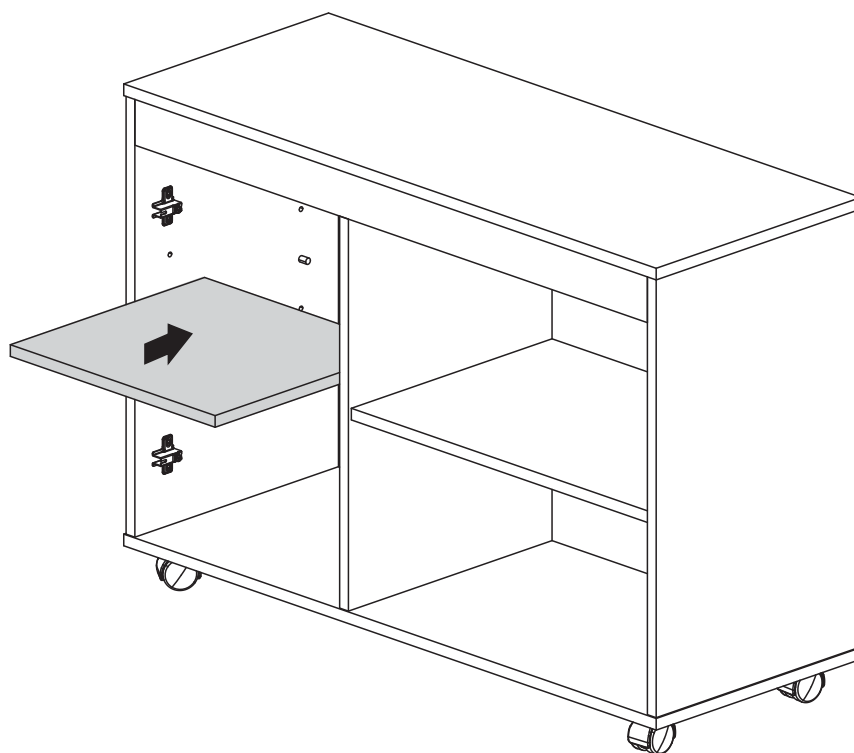
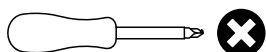

Passo 13

Paso/Step

PEÇA
Pieza/Piece

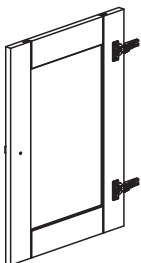

10 - PORTA x1

FERRAGEM
Herraje/Hardware

M  04

F  02

J  01

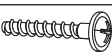
L  01

FERRAMENTA
Herramienta/Tool

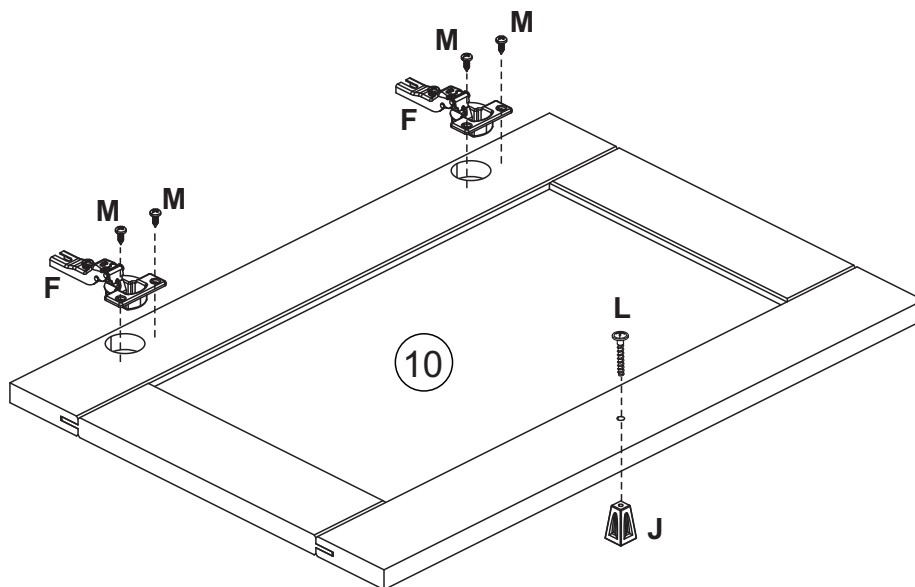
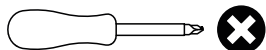

Passo 14

Paso/Step

PEÇA
Pieza/Piece

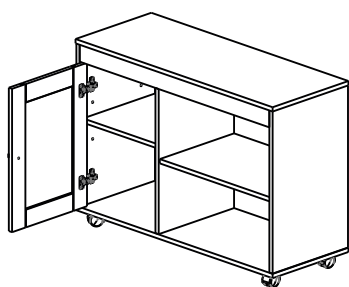

FERRAGEM
Herraje/Hardware

R  02

FERRAMENTA
Herramienta/Tool

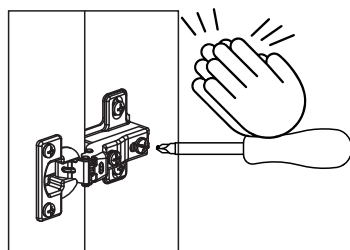
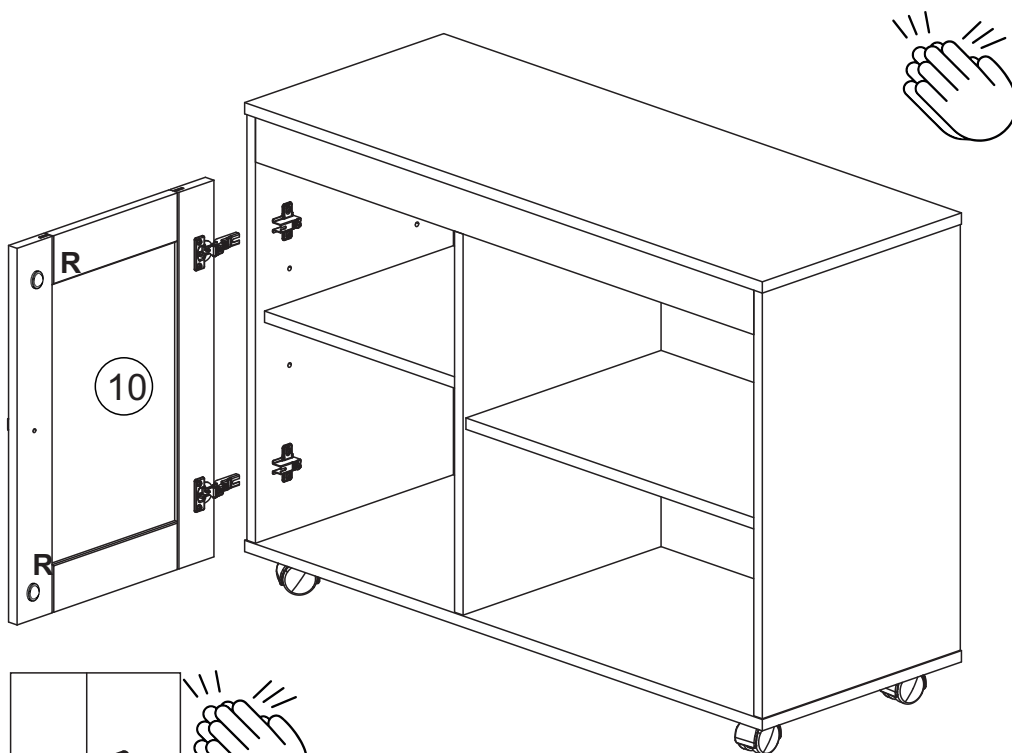
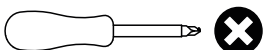

Detalhe 11
Detail/Detalle