

CÓDIGO DE PEÇAS | CODE OF PIECES | CÓDIGO DE PIEZAS

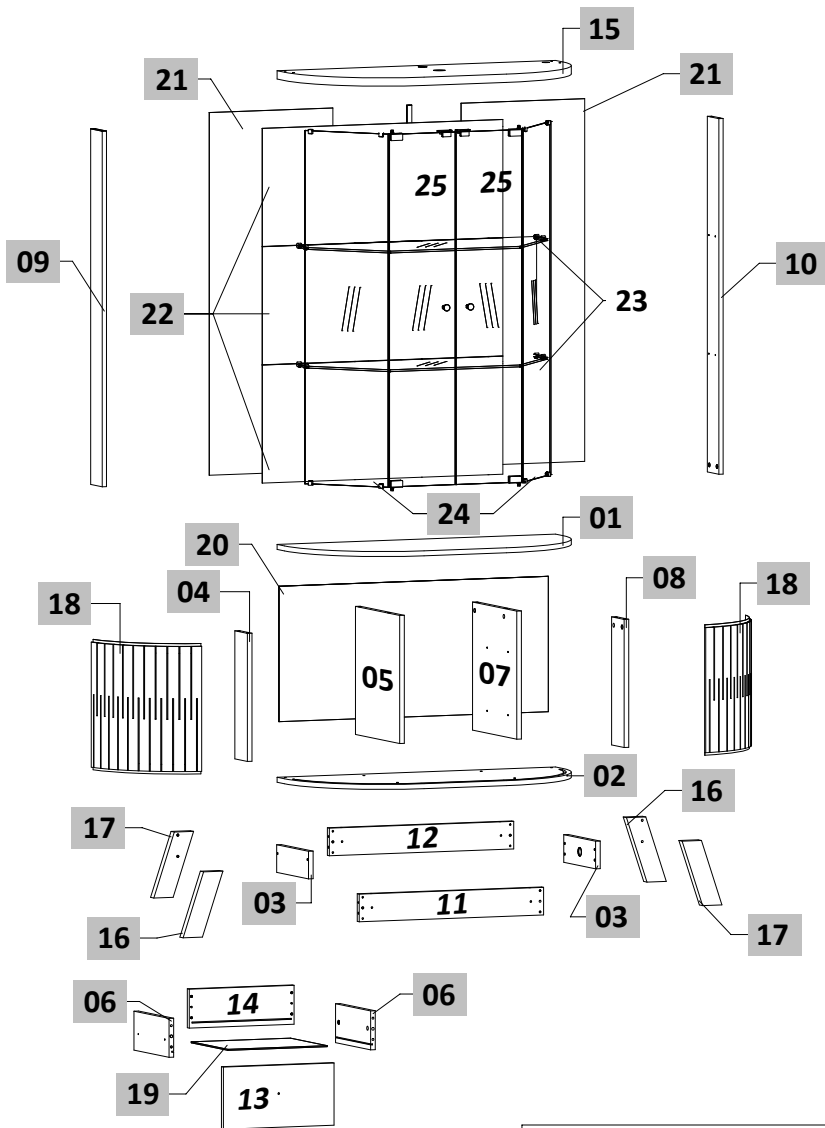

Edição: | Edition: | Edición: 18/06/2024

CUIDADOS ESPECIAIS | SPECIAL CARES | CUIDADOS ESPECIALES:

LIMPEZA: Pano limpo umedecido em água e sabão neutro - **BRILHO:** Flanela seca
CLEANING: Clean cloth humidified in water and neutral soap - **SHINE:** Dry flannel
LIMPIEZA: Tela limpia humedecida en la agua y el jabón neutro - **BRILLO:** Franela seca

INSTRUÇÕES DE MONTAGEM | ASSEMBLY INSTRUCTIONS | INSTRUCCIONES DE MONTAJE

- Prepare a montagem do móvel próximo ao local que ele ficará definitivamente e evite deslocá-lo depois de montado;
- Forre o chão com papelão ou similar e utilize a isomanta que vem entre as peças para evitar o contato entre elas durante a montagem;
- Monte o móvel obedecendo a ordem numérica da **seqüência de montagem (S.M.)**, identificando as peças pelo **código de peça (C.P.)** carimbado na mesma, de acordo com a tabela.

- Prepare the assembly of the close piece of furniture to the place that it will be definitively and avoid to move after done. Will be definitively and avoid to move after done;
- Cover the ground with cardboard or similar and use the isomanta that it comes among the pieces to avoid the contact among them during the assembly;
- Set up the piece of furniture obeying the numeric order of the **assembly sequence (S.M.)**, identifying the pieces by **code of piece (C.P.)** stamped in the same, in agreement with the table.

- Prepare la montaje del mobiliario proximo al lugar que estará definitivamente y evite mover después de hecho;
- Tape la suelo con cartón o similar y use la "isomanta" que viene entre las piezas para evitar el contacto entre ellos durante la montaje;
- Monte el mobiliario obedeciendo el orden numérico de la **sucesión de montaje (S.M.)**, identificando las piezas por el **código de piezas (C.P.)** de la misma estampado en esta, de acuerdo con la tabla.

Ferramentas necessárias para montagem (não fornecidas)



Parafusadeira / Screwdriver / Destornillador

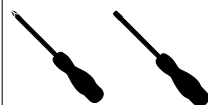

Chave de Fenda e Phillips



Martelo / Hammer / Martillo

Pessoas necessárias para montagem

People needed for assembly
Personas necesarias para el montaje



1 pessoa / people / persona



60 min

ASPECTO FINAL | FINAL ASPECT

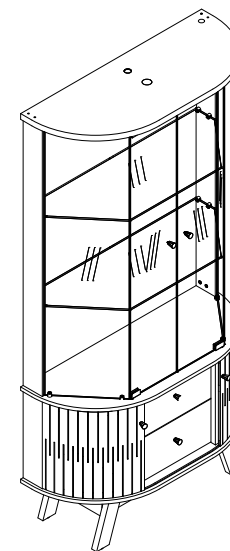

→ 0,675 m ↑ 1,800 m ↖ 0,358 m

Dimensão do Produto:

Product dimensions:

Dimensiones del producto:

REF.:	CÓDIGO DA PEÇA CODE PIECE CÓDIGO DE PIEZA			DESCRIÇÃO DA PEÇA PART DESCRIPTION DESCRIPCIÓN DE PIEZA	MATÉRIA PRIMA FEEDSTOCK	DIMENSÕES* DIMENSIONS DIMENSIONES	QUANT. AMOUNT CANTIDAD
	CALACATA OFF WHITE	CINAMOMO OFF WHITE	CUMARU OPALA				
01	204063.033	204063.037	204063.039	Tampo curvo Curved top Base izquierda curva	MDF	0,906 x 0,375 x 0,015	1
02	204064.033	204064.037	204064.039	Base curvo Curved base Base curva	MDP	0,906 x 0,375 x 0,015	1
03	204065.033	204065.037	204065.039	Rodapé lateral Side footer Pie de página lateral	MDP	0,244 x 0,083 x 0,015	2
04	204066.026	204066.037	204066.040	Lateral inferior esquerda Lower left side Lado inferior izquierdo	MDP	0,385 x 0,096 x 0,015	1
05	204067.026	204067.037	204067.040	Divisão inf. esquerda Lower left division División inf. izquierda	MDP	0,385 x 0,339 x 0,015	1
06	204068.026	204068.037	204068.040	Lateral de gaveta Drawer side Lado del cajón	MDP	0,269 x 0,117 x 0,015	4
07	204069.026	204069.037	204069.040	Divisão inf. direita Lower right division División inf. derecha	MDP	0,385 x 0,339 x 0,015	1
08	204070.026	204070.037	204070.040	Lateral inferior direita Lower right side Lado inferior derecho	MDP	0,385 x 0,096 x 0,015	1
09	204071.033	204071.037	204071.032	Lateral superior esquerda Upper left side Lado superior izquierdo	MDP	1,160 x 0,096 x 0,015	1
10	204072.026	204072.037	204072.034	Lateral superior direita Upper right side Lado superior derecho	MDP	1,160 x 0,096 x 0,015	1
11	204073.026	204073.037	204073.034	Rodapé frontal Front footer Pie de página frontal	MDP	0,600 x 0,083 x 0,015	1
12		204074.009		Rodapé traseiro Back footer Pie página posterior	MDP	0,600 x 0,083 x 0,015	1
13	204075.033	204075.037	204075.040	Frente de gaveta Drawer front Frente cajón	MDP	0,360 x 0,187 x 0,015	2
14	204076.033	204076.037	204076.040	Contra fundo de gaveta Drawer back Contra el fondo del cajón	MDP	0,341 x 0,117 x 0,015	2
15	204077.033	204077.037	204077.039	Chapéu curvo Curved hat Sombrero curvo	MDP	0,906 x 0,375 x 0,025	1
16	203968.033	203968.037	203968.039	Pés FRONTAL ESQUERDO Left FRONT FEET Pies FRONTALES IZQUIERDOS	MDP	0,207 x 0,060 x 0,025	2
17	203977.026	203977.037	203977.039	Pés FRONTAL DIREITO Right FRONT FEET Pies FRONTALES DERECHO	MDP	0,207 x 0,060 x 0,025	2
18	204078.026	204078.026	204078.040	Porta deslizante Sliding door Puerta deslizante	MDF	0,376 x 0,376 x 0,006	2
19	204079.026	204079.037	204079.040	Fundo de gaveta Drawer bottom Fondo del cajón	MDF	0,323 x 0,281 x 0,003	2
20	204080.026	204080.037	204080.040	Fundo inferior Lower bottom Fondo inferior	MDF	0,876 x 0,407 x 0,003	1
21	204081.026	204081.037	204081.039	Fundo superior Top bottom Fondo superior	MDF	1,183 x 0,437 x 0,003	2
22		105020090		Espelho Mirror Espejo	VIDRO	0,612 x 0,385 x 0,003	3
23		105020091		Prateleira de vidro Glass shelf Estante de vidrio	VIDRO	0,608 x 0,245 x 0,006	2
24		105020092		Lateral de vidro Glass side Lateral de vidrio	VIDRO	1,152 x 0,208 x 0,004	2
25		105020093		Porta de vidro Glass door Puerta de vidrio	VIDRO	1,149 x 0,212 x 0,004	2

LEGENDA DAS CORES | COLOR LEGEND | LEYENDA DE COLOR

009 - SEM PINTURA | UNPAINTED | SIN PINTAR

026 - OFF WHITE

033 - CALACATA

037 - CINAMOMO

039 - CUMARU

040 - OPALA

ACESSÓRIOS | ACCESSORIES | ACCESORIOS

PARAFUSOS | Screw | Tornillo

CÓDIGO | CODE

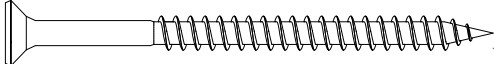
A   **1x 102100018**

Parafuso | Screw | Tornillo 5,0x70

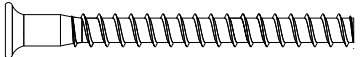
B   **16x 102100045**

Parafuso | Screw | Tornillo 5,0x50 (Estrutural)

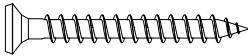
C   **12x 102100038**

Parafuso | Screw | Tornillo 4,0x35

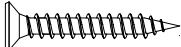
D   **6x 102100004**

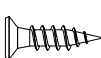

Parafuso | Screw | Tornillo 3,5x25









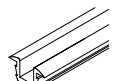
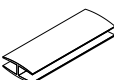









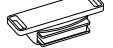

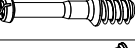

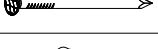
E   **60x 102100003**

Parafuso | Screw | Tornillo 3,5x14



RELAÇÃO DE COR DOS ACESSÓRIOS COLOR RATIO OF ACCESSORIES RELACIÓN DE COLOR DE ACCESORIOS

LETRA LETTER	DESCRIÇÃO DESCRIPTION DESCRIPCIÓN	MATÉRIA PRIMA FEEDSTOCK	COR COLOR	QUANTIDADE AMOUNT CANTIDAD			CÓDIGO CODE
				CALACATA OFF WHITE	CINAMOMO OFF WHITE	CUMARU OPALA	
c	 Tapa furo adesivo 18mm Adhesive hole cover 18mm Tapa agujero adhesivo 18mm	Plástico Plastic	Off White	20			102080216
			Calacata	4			102080259
			Cinamomo		24		102080286
			Opala			16	102080286
			Cumaru			8	102080289
d	 Giz p/ correção Touch-up chalk Tiza correctora	Cera Wax	Calacata Off White	1	1		102140008
			Cinamomo		1		102140023
			Opala			1	102140025
			Cumaru			1	102140026
e	 Trilho Flexível 4/8 1135mm Flexible rail 4/8 1135mm Carril flexible 4/8 1135mm	Plástico Plastic	Calacata Off White	1			102070640
			Cinamomo		1		102070647
			Cumaru			1	102070651
f	 Perfil I 1160mm	Plástico Plastic	Off White	1			102070670
			Cinamomo		1		102070671
			Cumaru			1	102070669

LETRA LETTER	DESCRIÇÃO DESCRIPTION DESCRIPCIÓN	MATÉRIA PRIMA FEEDSTOCK	QUANTIDADE AMOUNT CANTIDAD	CÓDIGO CODE
F	 Arruela Plastic washer Arruela	Plástico Plastic	2	102060001
G	 Bucha para parede 8mm Bushing for wall 8mm Buja para pared 8mm	Plástico Plastic	1	102060079
H	 Cantoneira 15x15mm Metal angle bracket 15x15mm Suporte angular 15x15mm	Metal	8	102050003
i	 Cantoneira 3 furos 3 hole angle bracket Cantoneira 3 furos	Metal	1	102050028
J	 Castanha girofix 12x10mm Girofix chestnut 12x10mm Castaña girofix 12x10mm	Metal	20	102050006
K	 Cavilha 6x30mm Dowel 6x30mm Clavija 6x30mm	Madeira Wood Madera	28	102050001
L	 Chapa fixador de fundo Bottom fixing plate Placa fijadora de fondo	Metal	7	102050002
M	 EVA espuma auto adesivo EVA self adhesive foam Espuma autoadhesiva EVA	Espuma Foam	2	102080283
N	 Fecho Magnético (R) Magnetic clasp Cierre magnético	Metal	2	102050046
O	 Fita dupla face 50mm x 20mm Double sided tape 50mm x 20mm Cinta de dos lados	Plástico Plastic	30	103050006
P	 Kit dobradiça para vidro lateral Side window hinge kit Kit de bisagras para ventana lateral	Metal	2	102010053
Q	 Pino girofix 5,0x30mm Girofix pin 5,0x30mm	Metal	12	102050007
R	 Pino girofix haste dupla 62x8mm Girofix double stem 62x8mm Giro-fijo asta doble 62x8mm	Metal	4	102050008
S	 Prego 10x10 Nail 10x10 Clavo 10x10	Metal	80	102100009
T	 Puxador diamante Diamond handle Tirador de diamante	Plástico Plastic	6	102020047
U	 Puxador U 25/5 p/porta vidro (CROMO) Glass door handle U (chrome) Manija de puerta de vidrio U	Metal	2	102020048
V	 Sapata 20x4mm (preto) Shoe 20x4mm (black) Sapata 20x4mm (negro)	Plástico Plastic	4	102110017
W	 Suporte prateleira de vidro Glass shelf support Soporte para estante de vidrio	Metal	16	102050033
X	 Kit Luminária LED e Interruptor LED light kit and Switch Juego de luces LED y Interruptor	Plástico Plastic	1	102010041
Y	 Corrediça telescópica 250mm Drawer slide Diapositivas del cajón	Metal	2	102010052
Z	 SACHE de cola 12g Sachet of glue 0,42oz Bolsita de pegamento 0,42oz	Cola Glue	1	102050020
a	 SACHE de Silicone 10g (transp.) Silicone sachet 0,42oz (transp.) Bolsita de silicone 0,42oz (transp.)	Silicone Silicona	1	102050047
b	 Etiqueta resinada Resin label Etiqueta de resina	Plástico Plastic	1	102060079

1º PASSO | PASS | PASO

PEÇAS
PIECES
PIEZAS

Montagem do rodapé frontal com os pés

Mounting the front skirting board with the feet

Montar el rodapié delantero con los pies

S.M.	C.P.
01	11
02	16
03	17

ATENÇÃO

Passar cola [Z] na peça 203968 e 203977 antes de fixa-la no rodapé

ATTENTION

Pass [Z] glue on the 203968 and 203977 piece before fixing it in the footer

ATENCIÓN

Pasar pegamento [Z] en la pieza 203968 y 203977 antes de fijarla en el pie de página

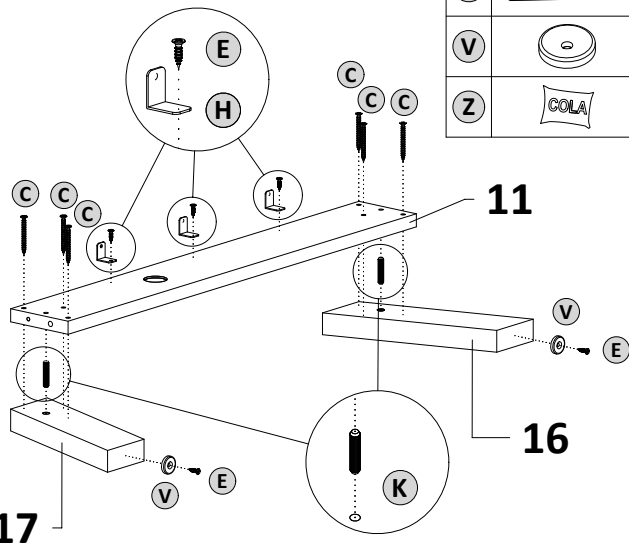
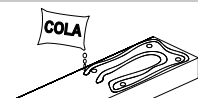

C		6
E		5
H		3
K		2
V		2
Z		1

2º PASSO | PASS | PASO

PEÇAS
PIECES
PIEZAS

Montagem do rodapé traseiro com os pés

Mounting the rear skirting board with the feet

Montar el rodapié trasero con los pies

S.M.	C.P.
01	12
02	16
03	17

ATENÇÃO

Passar cola [Z] na peça 203968 e 203977 antes de fixa-la no rodapé

ATTENTION

Pass [Z] glue on the 203968 and 203977 piece before fixing it in the footer

ATENCIÓN

Pasar pegamento [Z] en la pieza 203968 y 203977 antes de fijarla en el pie de página

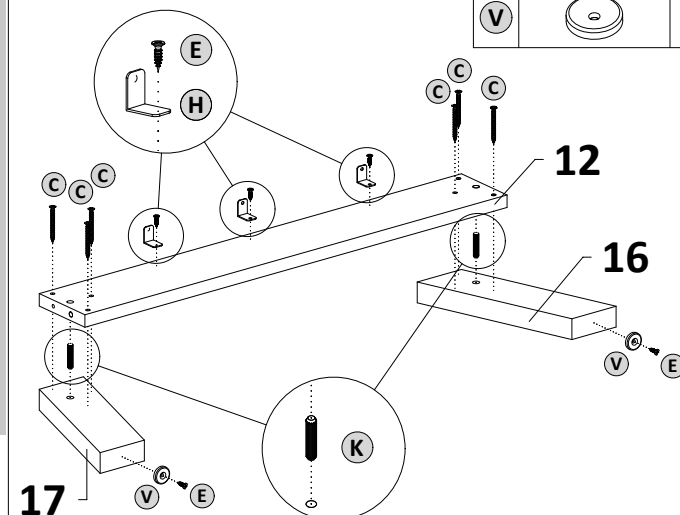
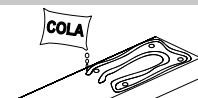

C		6
E		5
H		3
K		2
V		2

3º PASSO | PASS | PASO

PEÇAS
PIECES
PIEZAS

S.M.	C.P.
01	03
01	03

4º PASSO | PASS | PASO

E		2
H		2

03

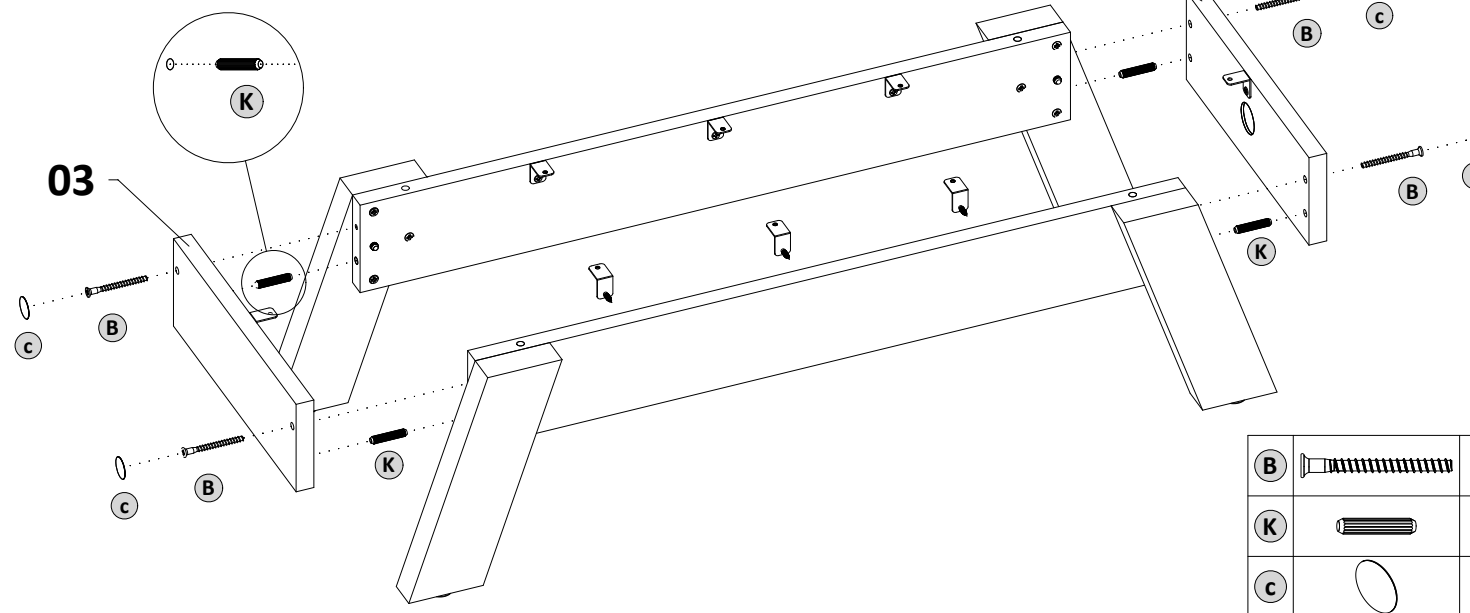
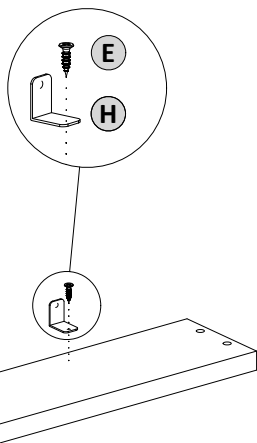





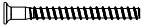
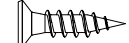

B		4
K		4
C		4

5º PASSO | PASS | PASO

PEÇAS
PIECES
PIEZAS

S.M.	C.P.
01	04
02	05
03	07
04	08
05	02
06	01



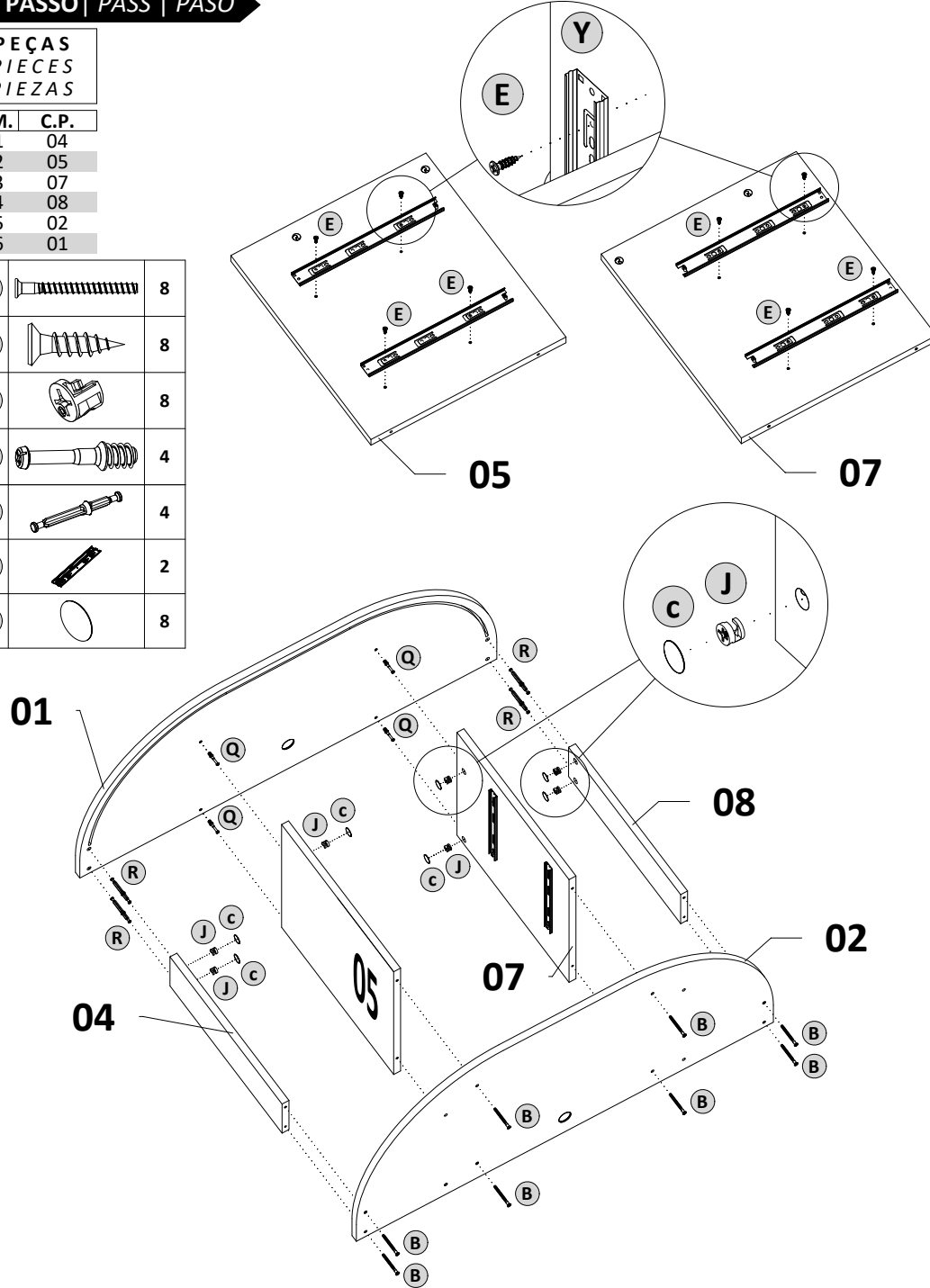



B		8
E		8
J		8
Q		4
R		4
Y		2
C		8

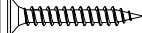
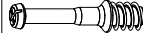
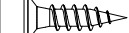

6º PASSO | PASS | PASO



PEÇAS
PIECES
PIEZAS

S.M.	C.P.
01	06
02	19
03	06
04	14
05	13

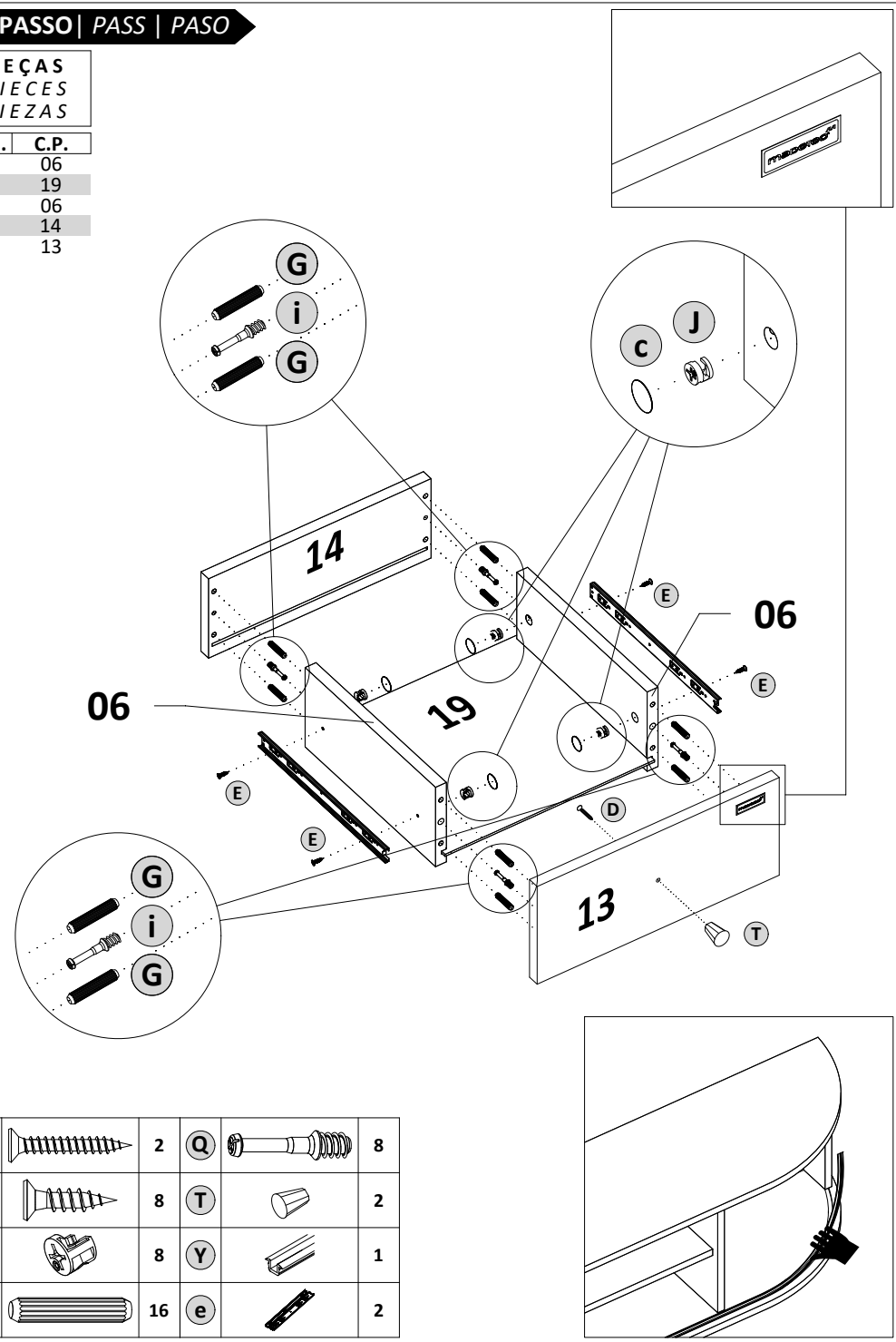
D		2	Q		8
E		8	T		2
J		8	Y		1
K		16	e		2



7º PASSO | PASS | PASO

PEÇAS		D		2
PIECES				
PIEZAS		T		2
S.M.	C.P.			
01	18			
02	18			

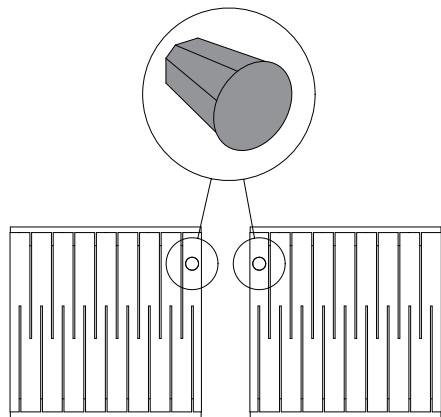

Porta esquerda.

Porta direita.

Left door.

Right door.

Puerta izquierda.

Puerta derecha.

Não deve ser montado a porta conforme imagem abaixo.

The door should not be mounted as shown in the image below.

No se debe montar la puerta como se muestra a continuación.

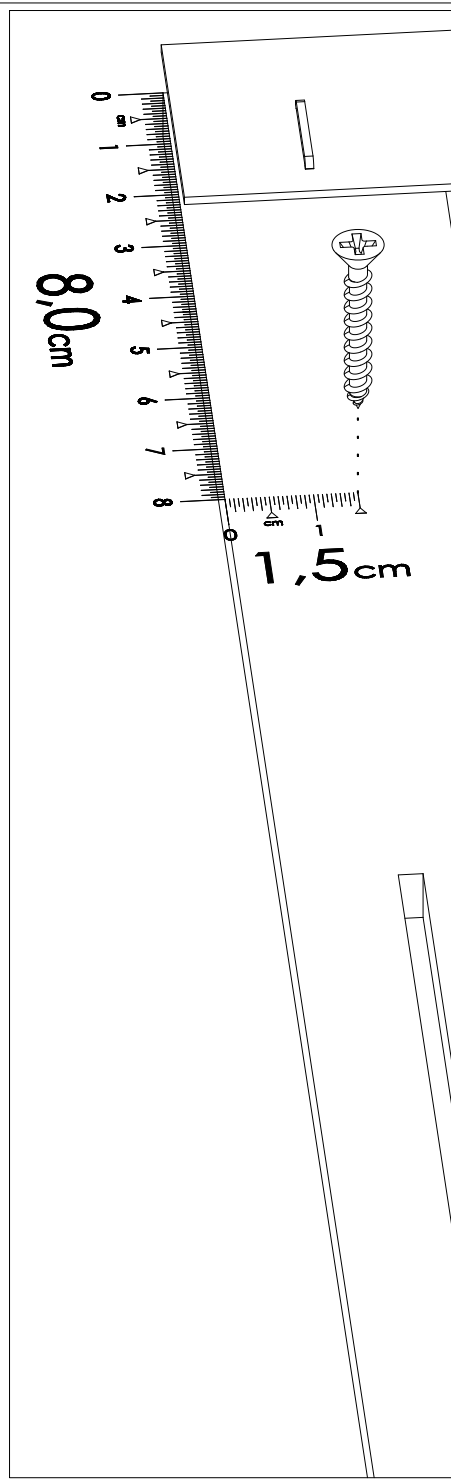
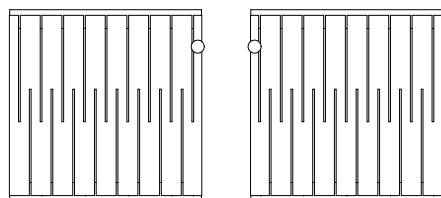
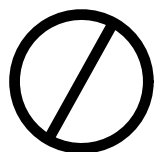

8º PASSO | PASS | PASO

Encaixando a parte superior da porta no canal superior.

Fitting the top of the door into the top channel.

Encajando la parte superior de la puerta en el canal superior.

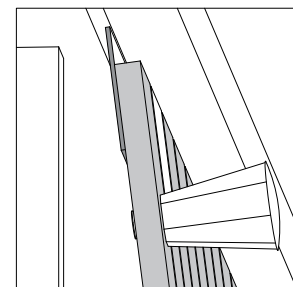

Soltar os pinos girofix para encaixar as portas conforme imagem.

Release the girofix pins to fit the doors as shown in the image.

Suelte los pines girofix para encajar los puertos según la imagen.

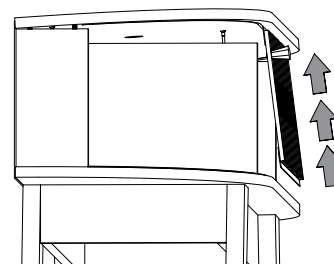

PORTA | DOOR | PUERTA

Encaixando a parte inferior da porta no canal do trilho.

Fitting the bottom of the door into the rail channel.

Encajando la parte inferior de la puerta en el canal del carril.

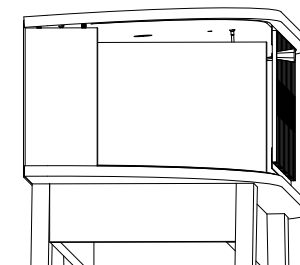

PORTA | DOOR | PUERTA



Encaixando a parte inferior da porta no canal do trilho e tampo.

Fitting the bottom of the door into the rail channel and top.

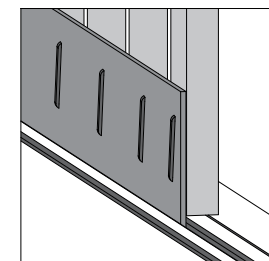
Encajando la parte inferior de la puerta en el canal del carril y la tapa.



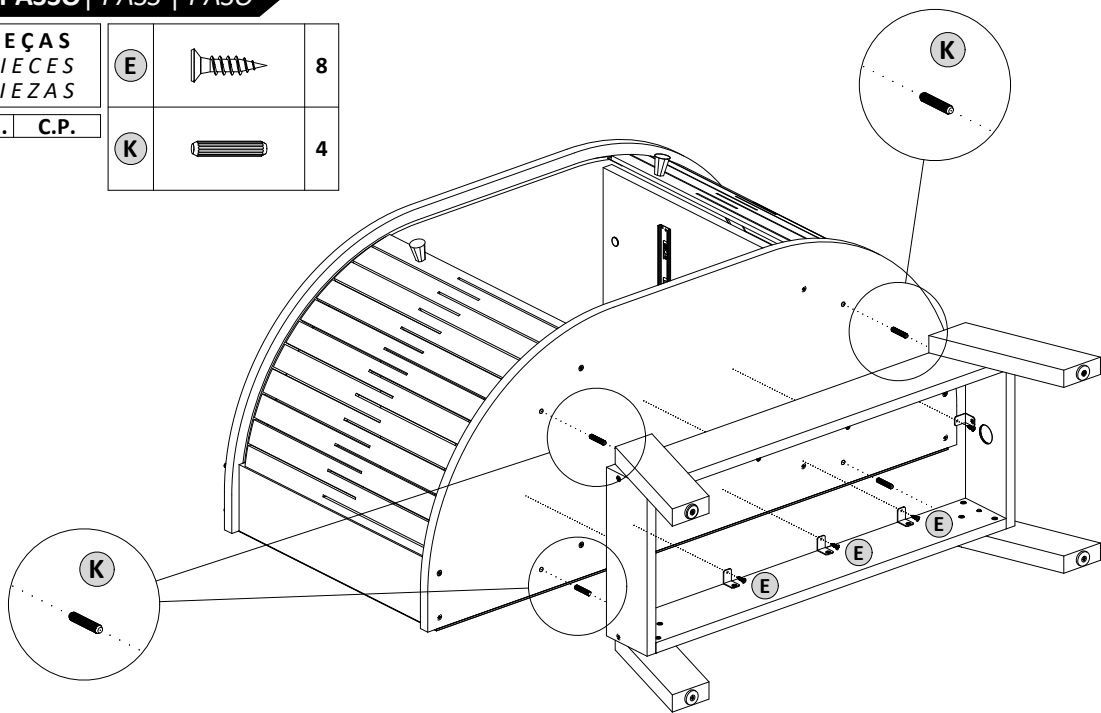

9º PASSO | PASS | PASO

PEÇAS PIECES PIEZAS		
S.M.	C.P.	
E		8
K		4



10º PASSO | PASS | PASO

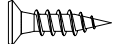

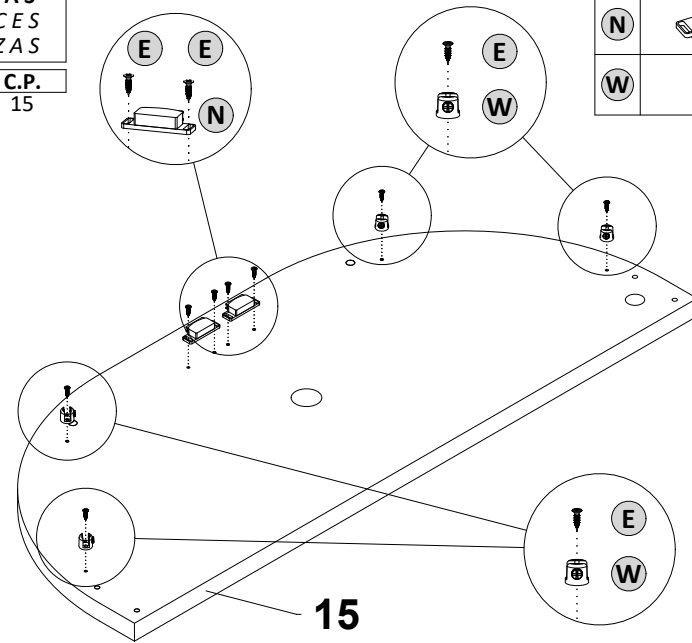

PEÇAS PIECES PIEZAS		
S.M.	C.P.	
01	15	

E		8
N		2
W		4

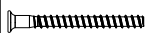
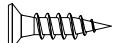

11º PASSO | PASS | PASO

PEÇAS PIECES PIEZAS		
S.M.	C.P.	
01	9	
02	10	
03	15	



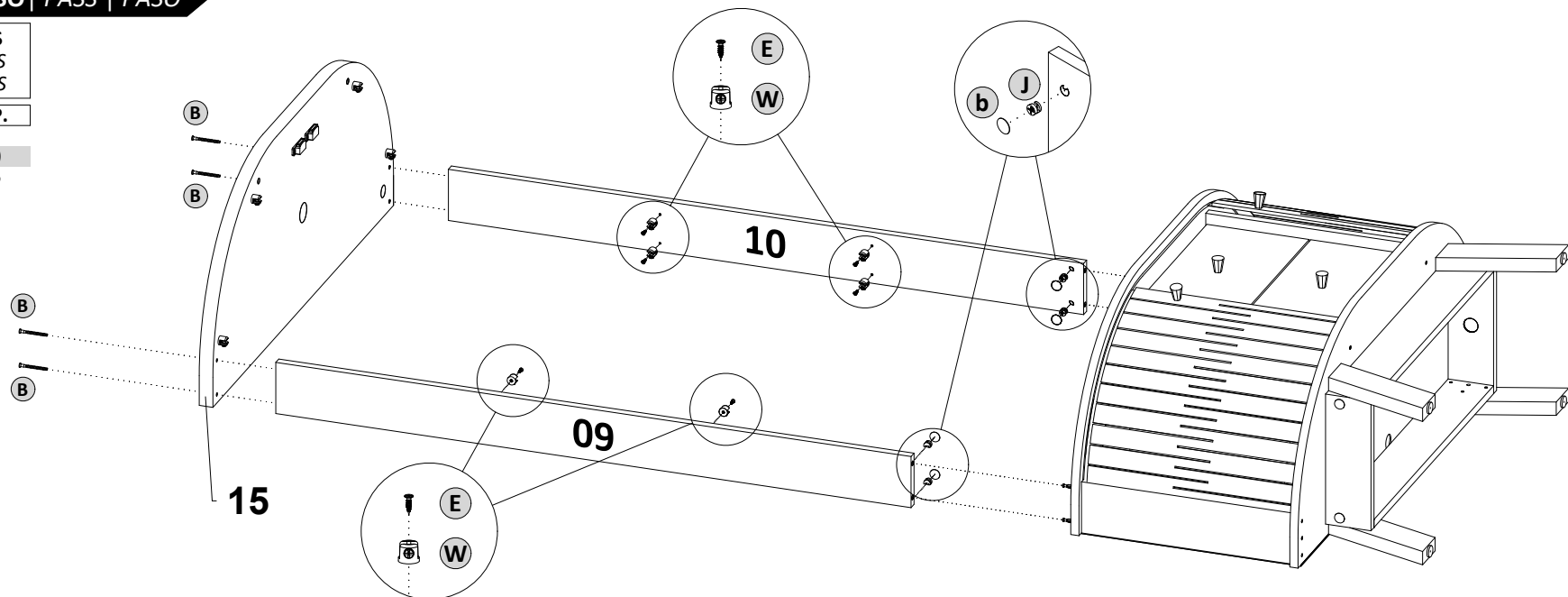

B		4
E		8
J		4
W		8
b		4

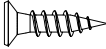

12º PASSO | PASS | PASO

PEÇAS
PIECES
PIEZAS

S.M.	C.P.
01	20
02	21
01	21

E		2
i		1
L		7
S		80
f		1

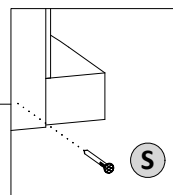
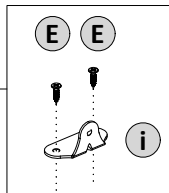
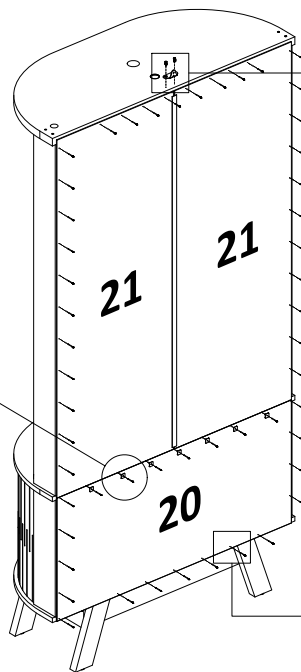
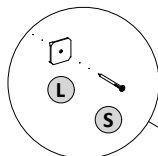

13º PASSO | PASS | PASO

PEÇAS
PIECES
PIEZAS

S.M.	C.P.
01	22
02	22
03	22

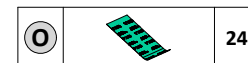
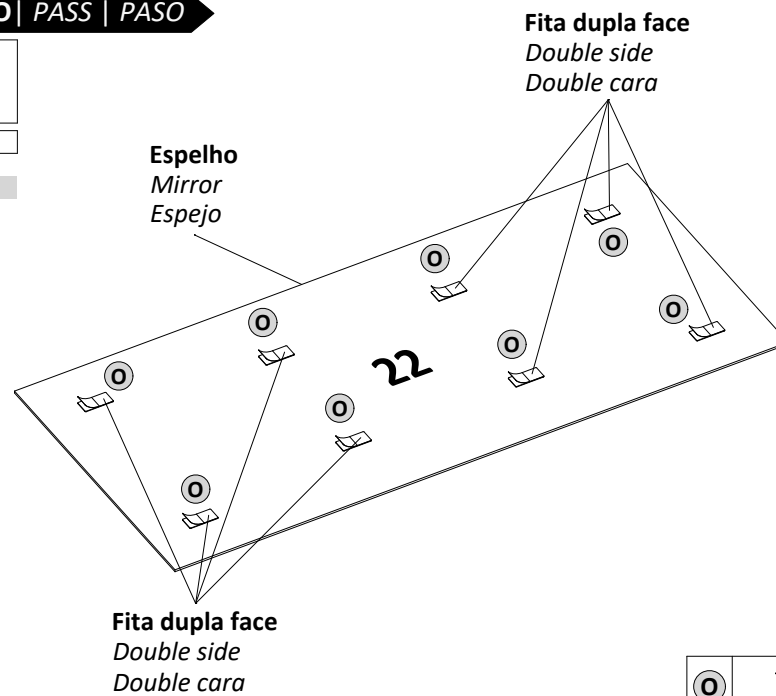

14º PASSO | PASS | PASO

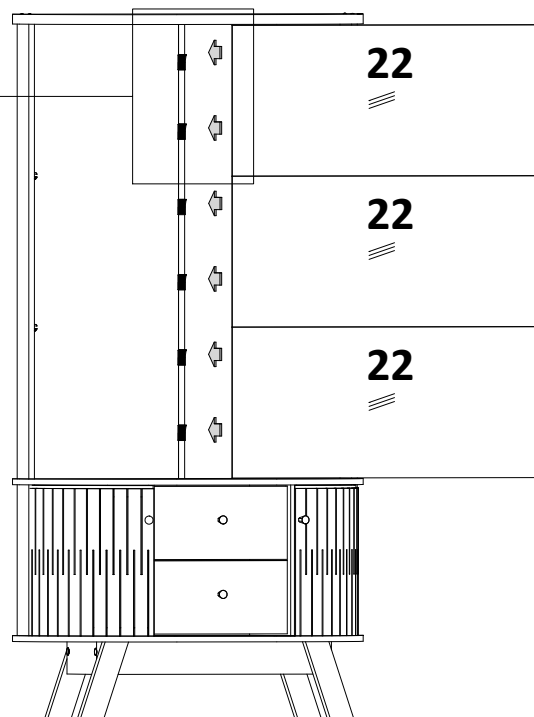
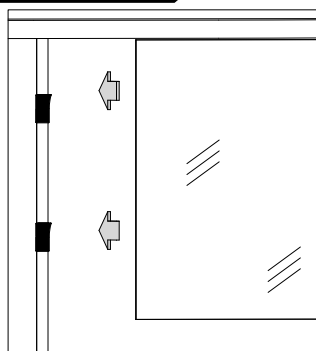

Colar espelhos com fita dupla face

Mirror necklace with double-sided tape

Collar espejo con cinta de doble cara



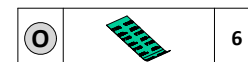

Colar 2 fitas dupla face no PERFIL por espelho conforme imagem

Glue two double-sided tapes on the PROFILE for mirror according to the image

Collar dos cintas de doble cara al PERFIL del espejo como se muestra en la imagen

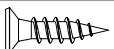

15º PASSO | PASS | PASO

PEÇAS PIECES PIEZAS			
	E		8
	P		1
S.M.	C.P.		
01	23		
02	23		
	W		5
	X		1

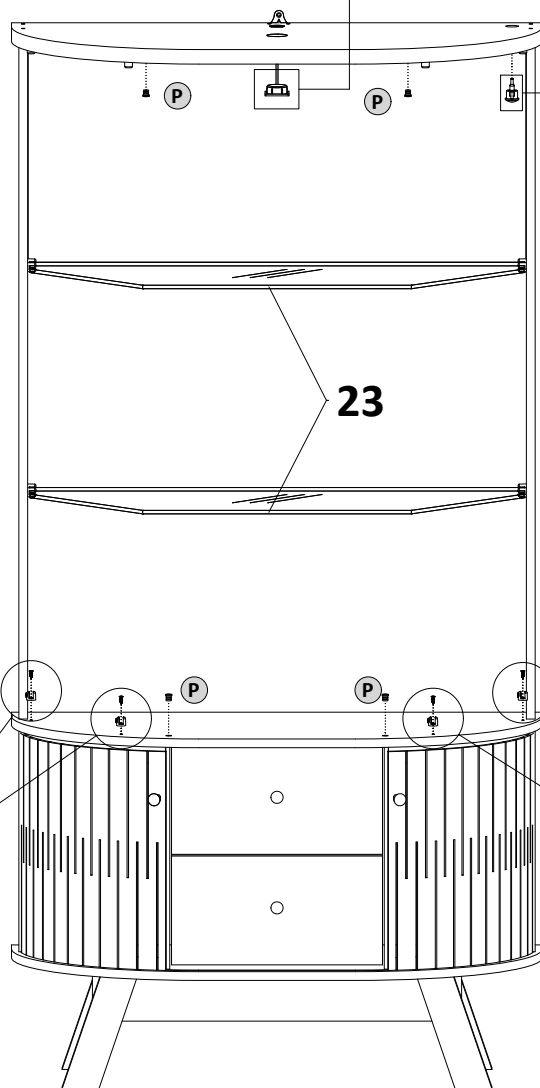
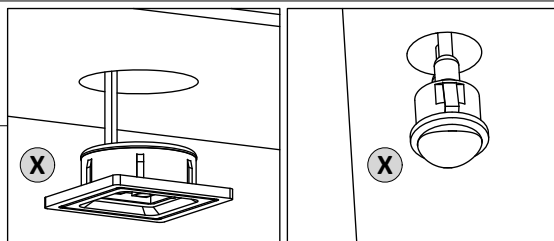

Encaixe as prateleiras de vidro e o kit luminária

Fit the glass shelves and the lamp kit

Colocar los estantes de cristal y el kit de lámpara

16º PASSO | PASS | PASO

PEÇAS PIECES PIEZAS	
S.M.	C.P.
01	24
02	24

Encaixe as laterais no suporte prateleiras de vidro (W)

Fit the sides into the glass shelf support (W)

Encaje los lados en el soporte del estante de vidrio (W)

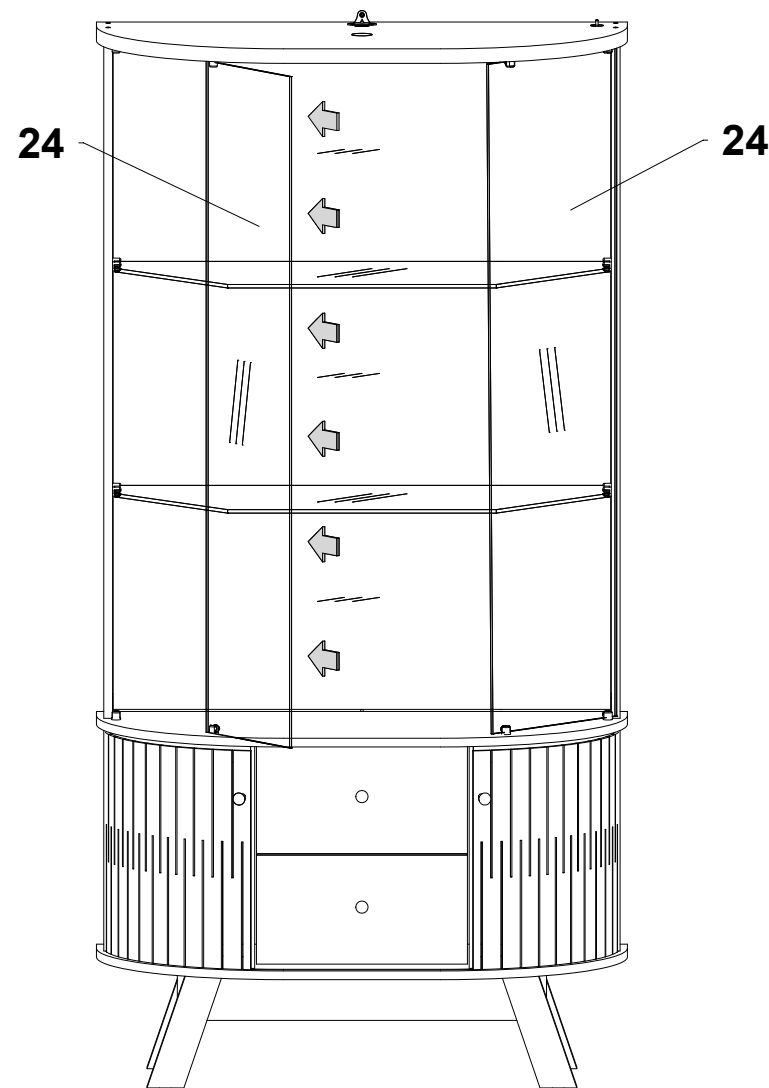

17º PASSO | PASS | PASO

PEÇAS
PIECES
PIEZAS

Encaixando os acessórios na porta de vidro

Fitting the accessories to the glass door

Montaje de los accesorios en la puerta de cristal

S.M.	C.P.
01	25
02	25

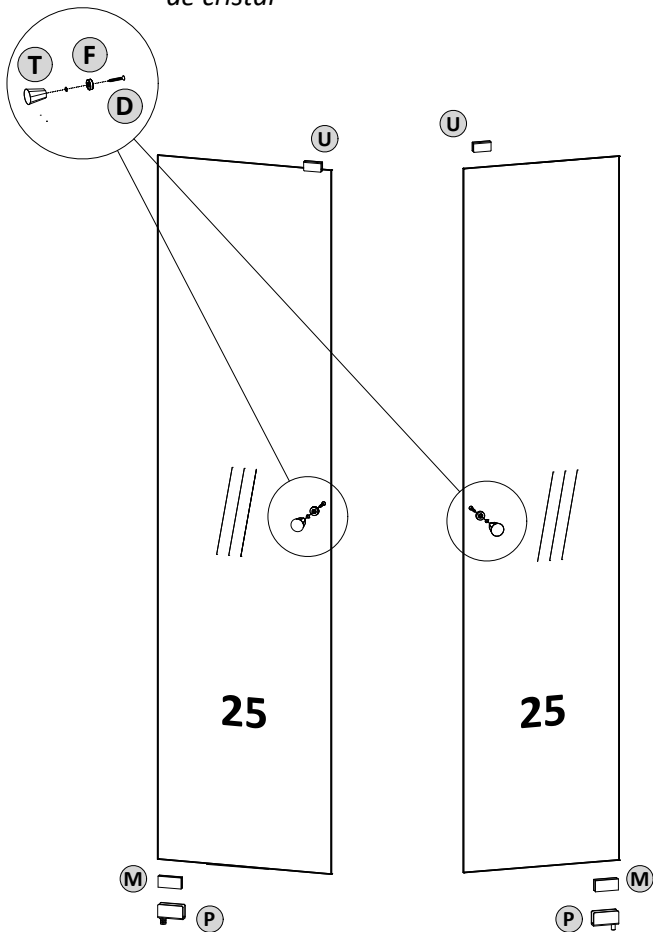

D		2	M		2	T		2
F		2	P		2	U		2

18º PASSO | PASS | PASO

Encaixando as portas de vidro na Cristaleira

Fitting the glass doors to the Glass cabinet

Encajando las puertas de vidrio en la cristalera

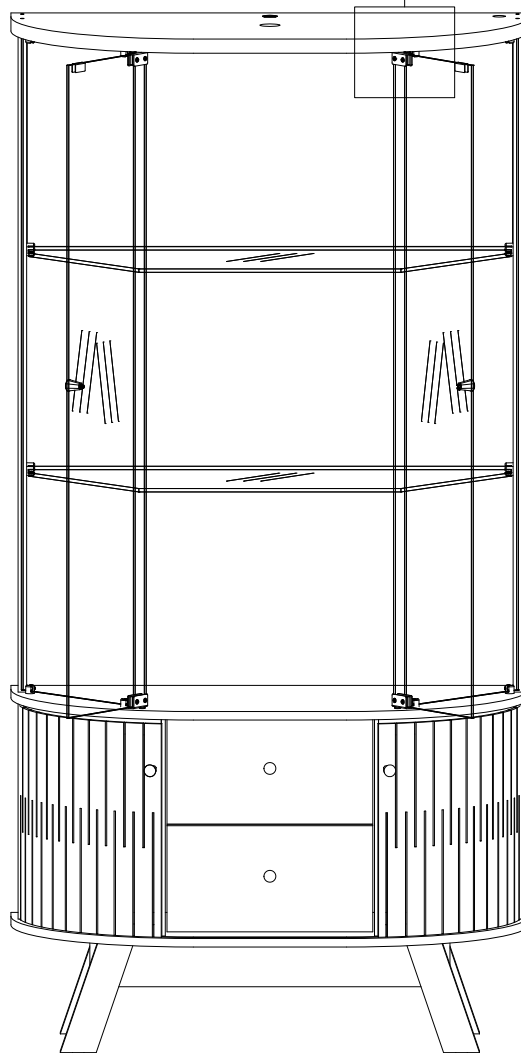
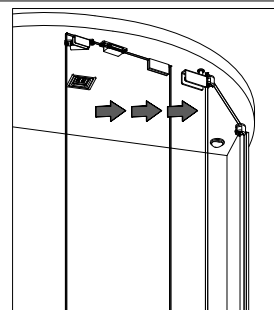

19º PASSO | PASS | PASO

PEÇAS
PIECES
PIEZAS

S.M. C.P.

Furar a parede, colocar a Bucha 0,8mm, encostar a Cristaleira na parede e apertar com Parafuso 5,0 x 70

Drill the wall, insert the 0.8mm anchor, place the Hutch against the wall and tighten with a 5.0 x 70 screw

Taladre la pared, inserte el enclaje de 08mm, coloque la conejera contra la pared y apriete con un tornillo de 5,0 x 70

A		1
G		1

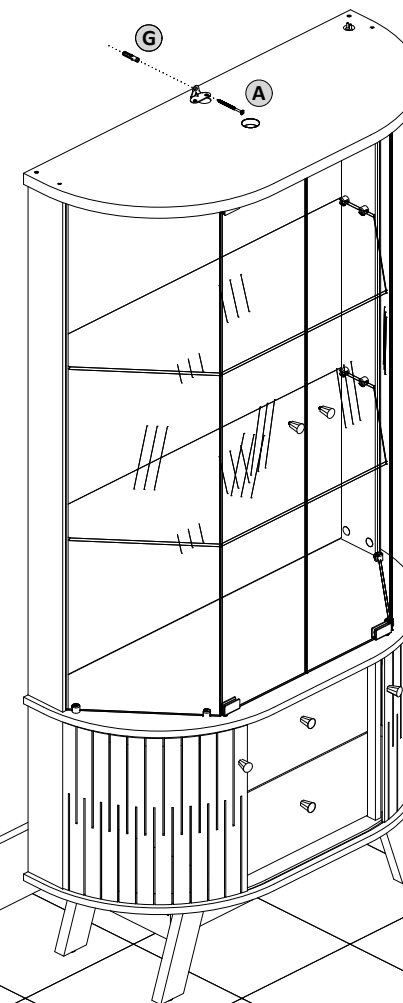



Atenção!!!
 Após finalizar a montagem, aplique uma pequena quantidade de silicone no trilho plástico. Em seguida limpe com pano seco.

Attention!!!
 After finishing the assembly, **apply** a small amount of **SILICONE** to the plastic rail. The clean the excess with a dry cloth.

Atención!!!
 Después de finalizar el montaje, **aplique** una pequeña cantidad de **SILICONA** en el carril plástico. Luego limpie el exceso con un paño seco.

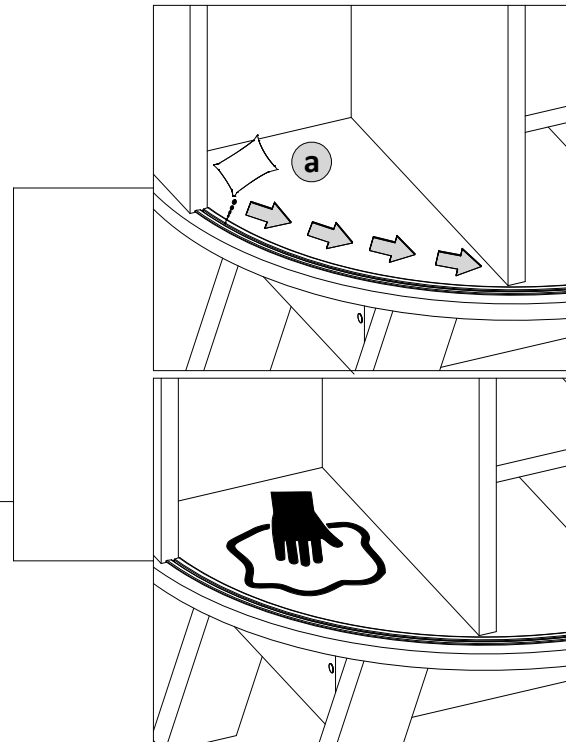
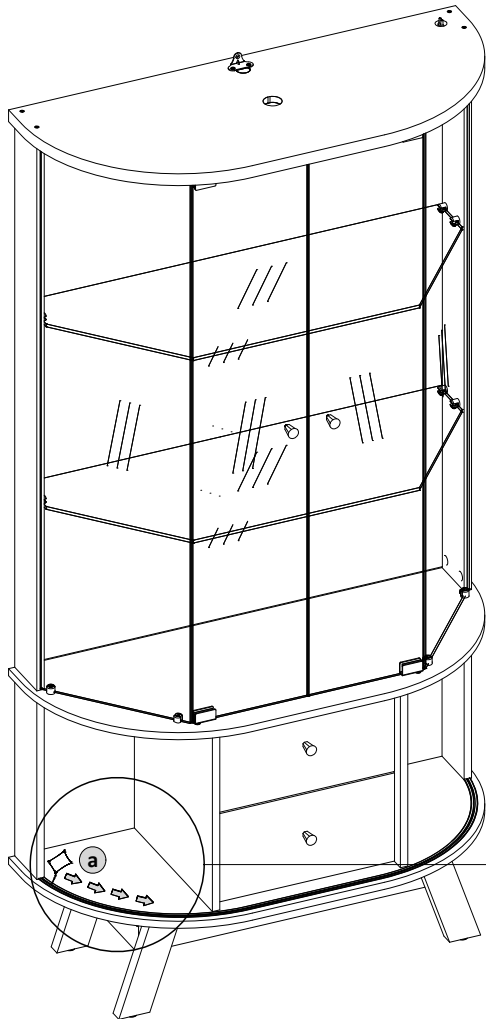

PESO SUPORTADO
WEIGHT SUPPORTED
PESO SOPORTADO

