













LISTA DE FERRAGENS / LISTA DE ACCESORIOS / HARDWARE LIST			LISTA DE PEÇAS / LISTA DE PIEZAS / PARTS LIST			
COD	DESCRIÇÃO / DESCRIPCIÓN / DESCRIPTION	QTD	COD	DESCRIÇÃO / DESCRIPCIÓN / DESCRIPTION	DIM / DIM / DIM	QTD
A	 CAVILHA Ø6X30 CLAVILIA Ø6X30 WOOD DOWEL Ø6X30	8	01	BASE/ BASE/ BASE	560 x 350 x 15	1
B	 PARAFUSO CC 3,5X14 REBAIXE TORNILLO CC 3,5X14 SCREW CC 3,5X14	50	02	LATERAL DIREITA/ LATERAL DERECHA/ RIGHT SIDE	550 x 350 x 15	1
C	 PARAFUSO CC 3,5X40 TORNILLO CC 3,5X40 SCREW CC 3,5X40	11	03	LATERAL ESQUERDA/ LATERAL IZQUIERDA/ LEFT SIDE	550 x 350 x 15	1
DB	 DOBRADIÇA Ø35 BAIXA COM AMORTECEDOR BISAGRA HINGE	4	04	FRENTE FALSA/ FRENTE FALSA/ FALSE FRONT	590 x 130 x 15	1
F	 PARAFUSO CC 5X50 TORNILLO CC 5X50 SCREW CC 5X50	4	05	TRAVESSA/ TRAVESAÑO/ CROSSBEAM	560 x 60 x 15	1
G	 SUPORTE FIXAÇÃO SOPORTE DE FIJACIÓN FIXING SUPPORT	2	06	TRAVESSA P/ PUXADOR/ TRAVESAÑO P/ TIRADOR/ CROSSBEAM FOR HANDLE	560 x 60 x 15	1
H	 PROTEÇÃO SUP. CANTONEIRA PROTECCIÓN ANGLE BRACKET	2	07	BASE PARA PUXADOR/ BASE P/ TIRADOR/ BASE FOR HANDLE	560 x 60 x 15	1
I	 BUCHA PLÁSTICA CASQUILLO BUSHING	4	08	PORTA/ PUERTA/ DOOR	290 x 375 x 15	2
L	 CANTONEIRA 18x18 ESQUINERO 18x18 CORNER	4	09	ESPELHO/ ESPEJO/ MIRROR	550 x 550 x 15	1
M	 PREGO 10X10 CLAVO 10X10 NAIL	30	10	FUNDO/ FONDO/ BACK PANEL	580 x 500 x 3	1
N	 ADESIVO TAPA FURRO STICKER ADHESIVE	8				
U	 OZINI MÓVEIS	1				
V	 COLA	1				
Z	 SUPORTE "Z" SOPORTE "Z" SUPPORT "Z"	2				

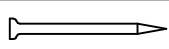

**"IMPORTANTE LER COM ATENÇÃO  
E GUARDAR PARA EVENTUAIS  
CONSULTAS".**

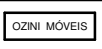
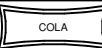
**"IMPORTANTE LEER CON ATENCIÓN Y GUARDAR PARA  
EVENTUALES CONSULTAS".**

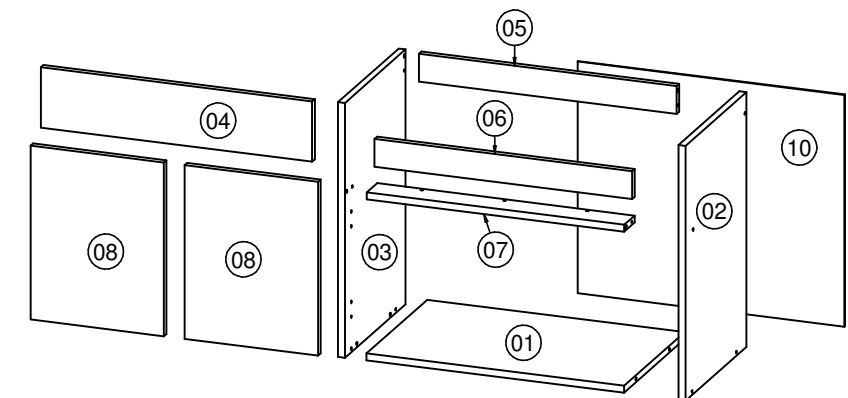
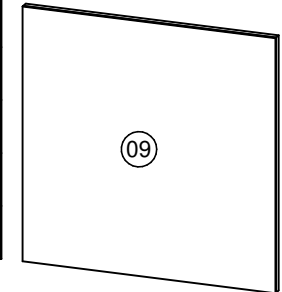
**"IMPORTANT TO READ CAREFULLY AND SAVE FOR ANY QUERIES".**

FERRAMENTAS NECESSÁRIAS:  
HERRAMIENTAS NECESARIAS:  
NECESSARY TOOLS:



