

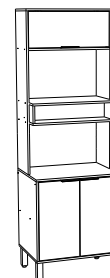

Rodovia SC-492 - Km 10 - B. Industrial
89905-000 - Bandeirante - SC
Fone: (49) 3622-4549
e-mail: mxmoveis@mxmoveis.com.br

Ref. TGL01

Torre quente 2 fornos
Cozinha/Cocina
GLORIA

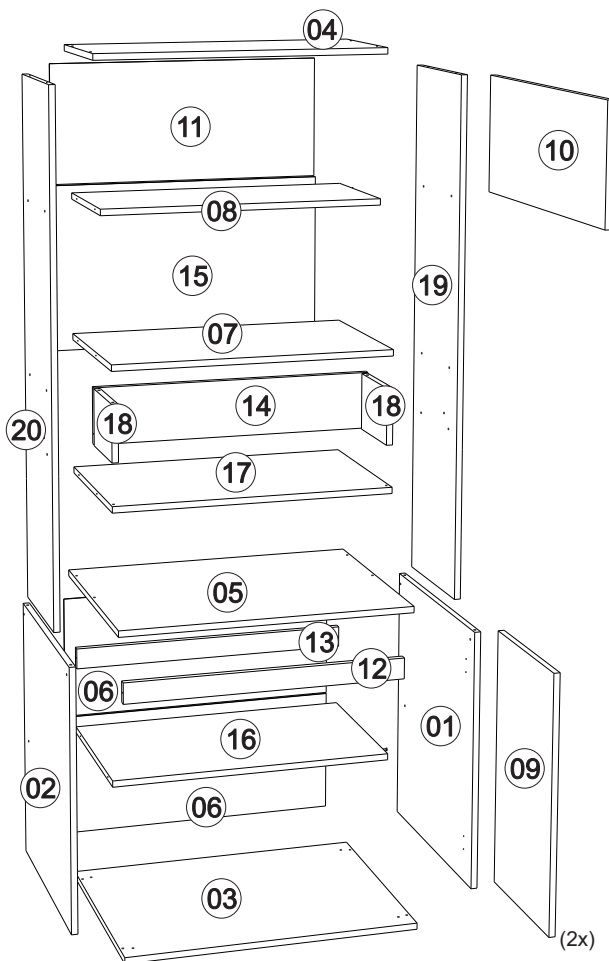

Nº	CÓDIGO ASSISTÊNCIA CODE ATTENDANCE	NOME DA PEÇA/DESCRIPCIÓN PIEZAS/DESCRIPTION PARTS	MEDIDAS (mm) MEASURES (mm)	QTD.	CASTANHO OFF WHITE	BRANCO NEVE BRANCO NEVE
01	TGL01.17.00	Lateral externa direita/Lateral derecha/Right side	625x516x15	01	263926	277580
02	TGL01.18.00	Lateral externa esquerda/Lateral izquierda/Left side	625x516x15	01	263928	277582
03	TGL01.01.00	Base Inferior/Base/Shelf	700x516x15	01	263920	277577
04	TGL01.05.00	Base superior/Base superior/Top base	700x300x15	01	263924	277579
05	TGL01.33.00	Tampo/Tapa/cover	700x516x15	01	263932	263932
06	TGL01.13.00	Forro/Revés/botton	686x300x2.5	02	260938	260938
07	TGL01.02.02	Base micro/Base	670x400x15	01	263923	263923
08	TGL01.01.01	Base inferior aéreo/Base inferior/Aerial lower base	670x300x15	01	263921	277578
09	TGL01.25.00	Porta balcão/Puerta/Balcony door	615x329x15	01	260953	277584
10	TGL01.25.01	Porta aéreo torre/Puerta/aerial door tower	662x277x15	01	264015	277585
11	TGL01.13.02	Forro aereo/Revés/Air lining	686x297x2.5	01	260940	260940
12	TGL01.28.00	Ripa sustentação frontal/Lama de soporte frontal/Front support slat	670x50x15	01	263930	277586
13	TGL01.28.01	Ripa sustentação tras/Listón de respaldo/Back support slat	670x50x15	01	260956	260956
14	TGL01.28.00	Ripa sustentação/listón de apoyo/Support slat	670x135x15	01	263931	277586
15	TGL01.13.01	Forro/Revés/botton	686x412x2.5	01	263918	277576
16	TGL01.02.00	Base interna/Base/Inner base	670x387x15	01	261612	261612
17	TGL01.02.01	Base interna/Base/Inner base	670x400x15	01	263922	263922
18	TGL01.38.00	Ripa de acabamento/Tabilla de acabado/Finishing clapboard	209x135x15	01	263925	263925
19	TGL01.17.01	Lateral externa direita/Lateral derecha/Right side	1265x300x15	01	263927	277581
20	TGL01.18.01	Lateral externa esquerda/Lateral izquierda/Left side	1265x300x15	01	263929	277583

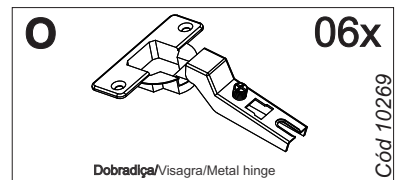
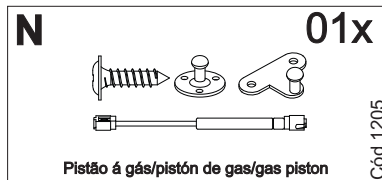
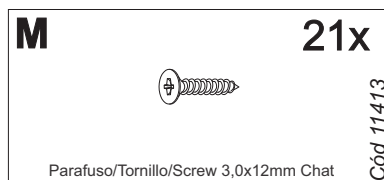
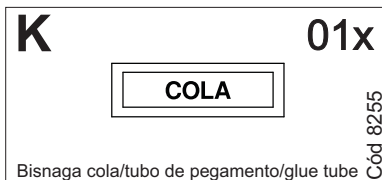
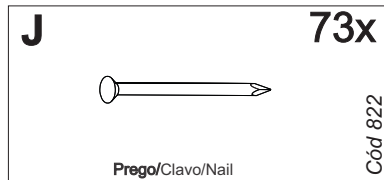
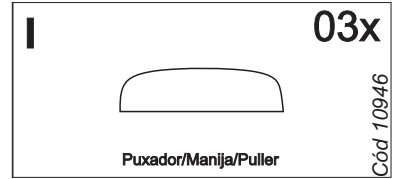
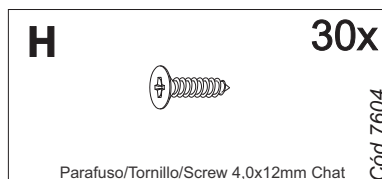
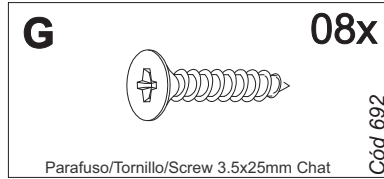
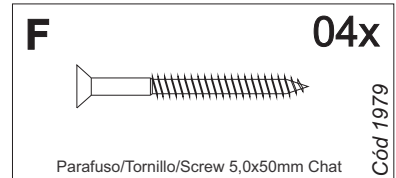
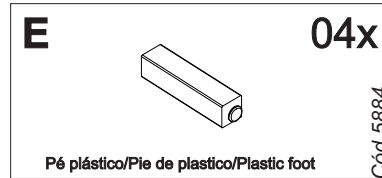
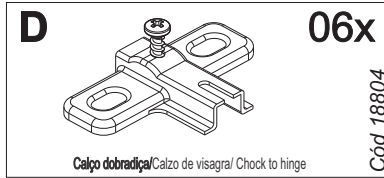
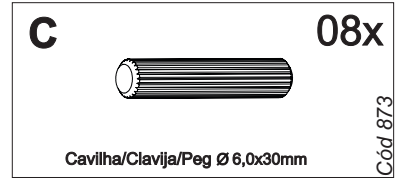
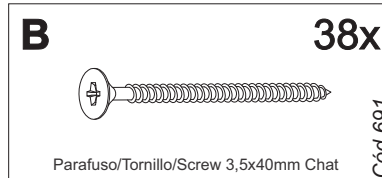

Ferragens/Herrajes/Hardware





Obs: a régua serve para medição da ferragem.
Nota: la regla se utiliza para medir el hardware.
Note: the ruler is used to measure the hardware.



Medidas em mm
Measures in mm
Meduras en mm

 *Usar os parafusos (G) para unir este módulo a outro.
Usar los tornillos (G) para unirse este módulo a otro. 
*Use the screws (G) to connect this module to another.

 Giz para madeira
Produto para ser aplicado em caso de riscos na superfície.

 Giz para madeira
Product to be applied in case of scratches on the surface.

 Giz para madeira
Producto para ser aplicado en caso de rayas en la superficie.

Limpeza/Limpieza

- ≠ Use um pano levemente umedecido com água, seguido de pano seco.
- ≠ Use solamente un paño húmedo con agua y después un paño seco.
- ≠ Nunca utilize produtos químicos ou abrasivos.
- ≠ No utilice productos químicos o abrasivos.

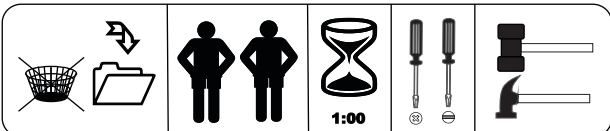

Pré-Montagem/Preparación Piezas

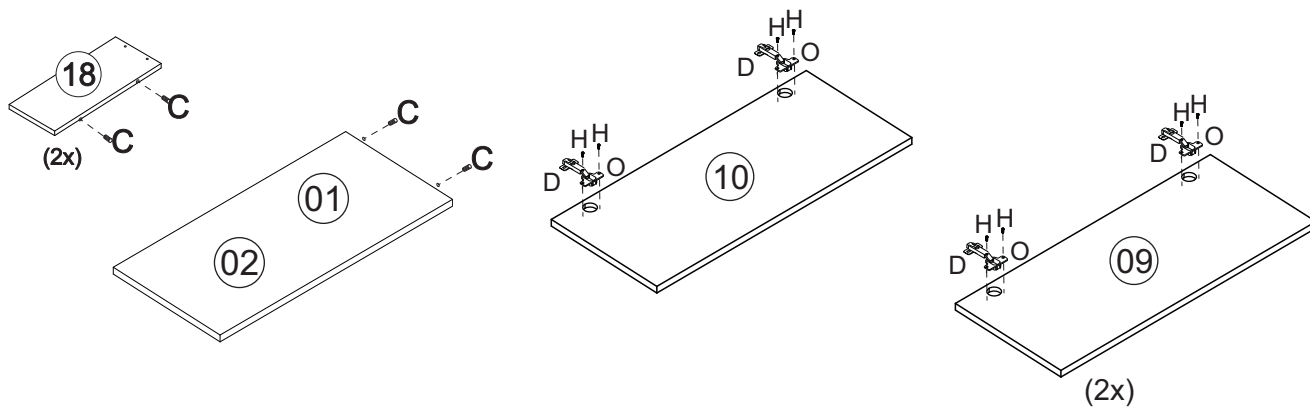

01 Montagem/Montaje

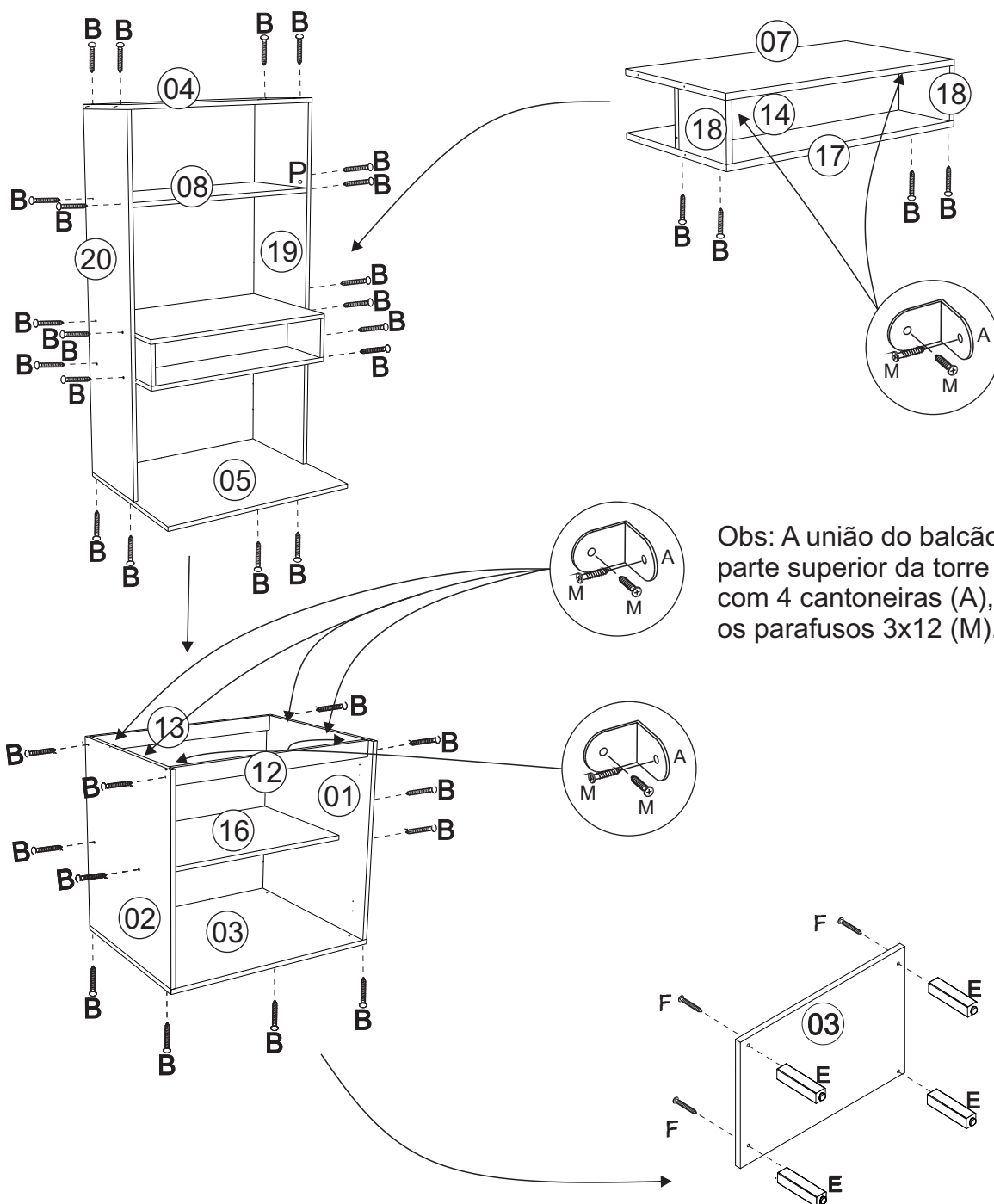

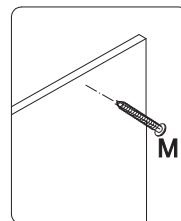
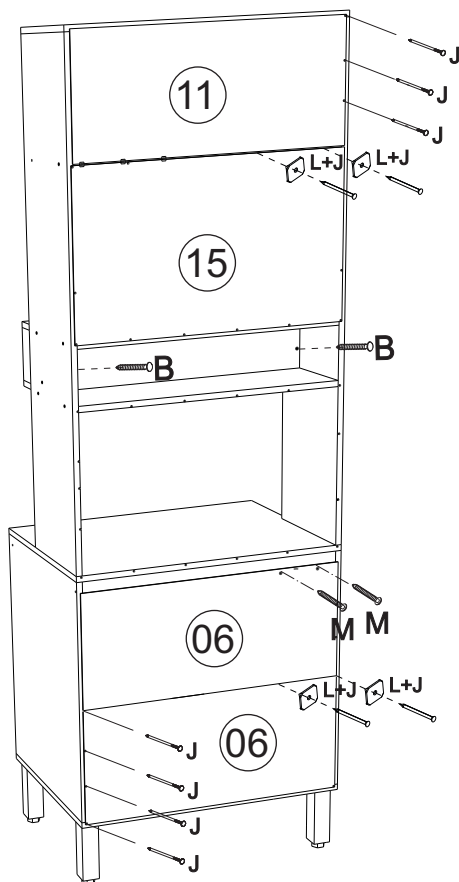
02**Montagem/Montaje**

*Colocar um parafuso (M) a cada 100mm
 *Colocar un tornillo (M) cada 100mm
 *Place a screw (M) every 100mm

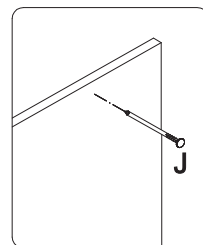

*Colocar um prego (J) a cada 100mm
 *Colocar un clavo (J) cada 100mm
 *Place a nail every (J) 100mm

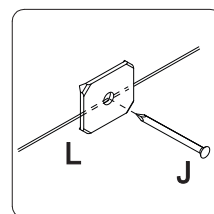

*Usar o prego (J) e a junção (L) a cada 100mm
 *Usar el clavo (J) y la junta (L) cada 100mm
 *Use the nail (J) and the joint (L) every 100mm

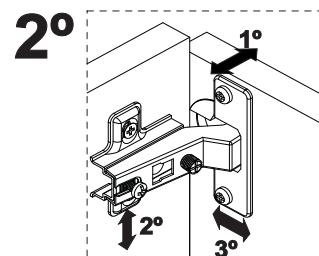
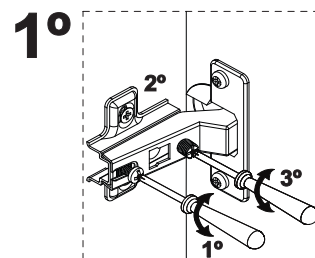
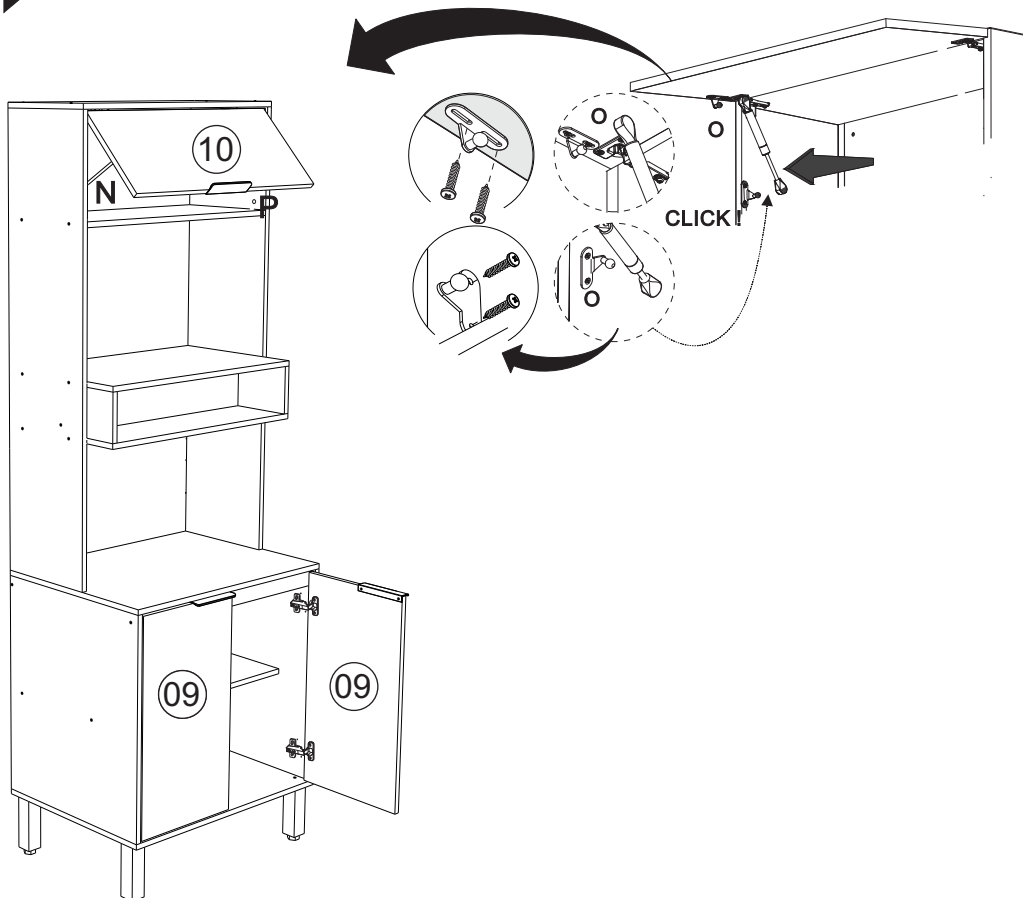
03**Montagem/Montaje**



Rodovia SC-492 - Km 10 - B. Industrial
89905-000 - Bandeirante - SC
Fone: (49) 3622-4549
e-mail: mxmoveis@mxmoveis.com.br

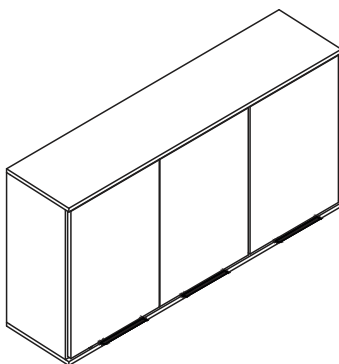

Ref. AGL04

Aéreo 1200
Armario 1200
Air 1200
Cozinha/Cocina
GLORIA

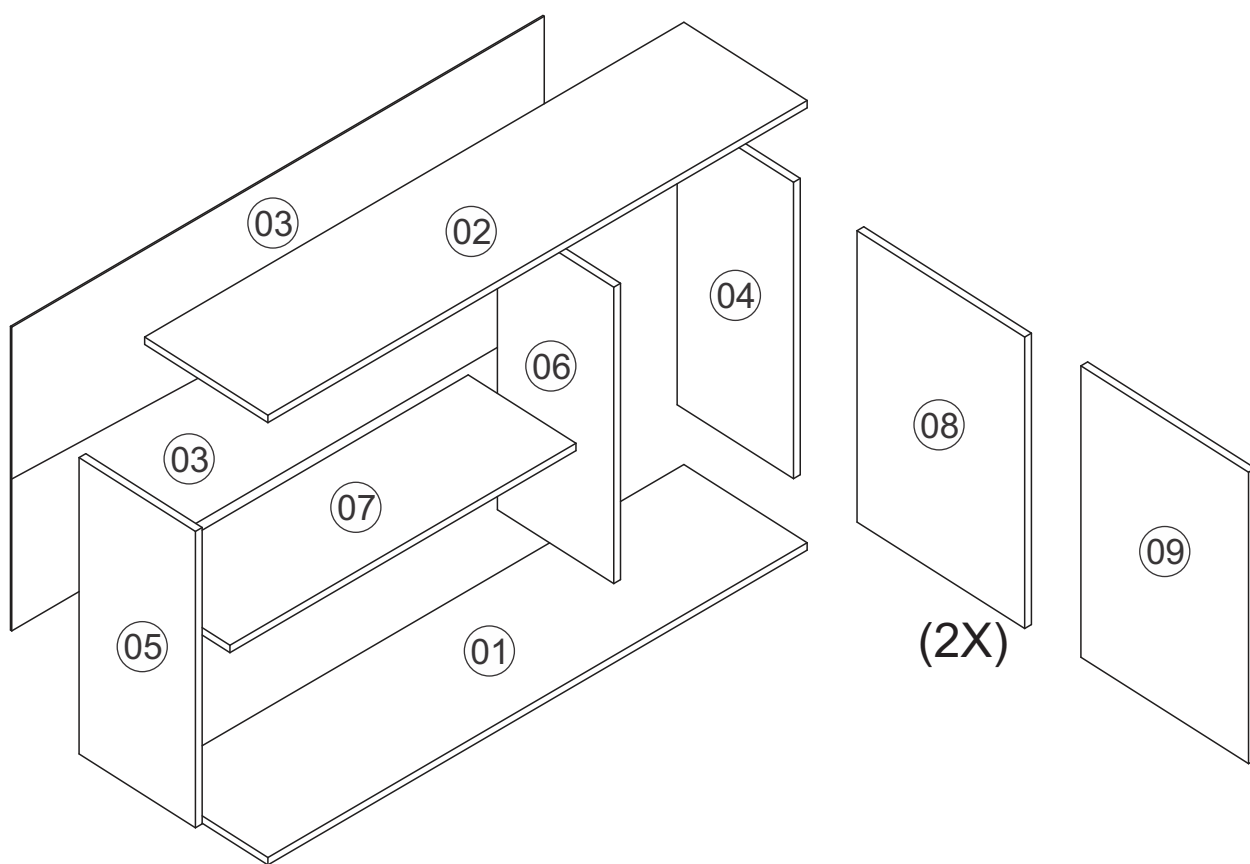

Nº	CÓDIGO CODE ASSISTÊNCIA ATTENDANCE	NOME DA PEÇA/DESCRIPCIÓN PIEZAS/DESCRIPTION PARTS	MEDIDAS (mm) MEASURES (mm)	QTD.	CASTANHO CASTANHO	BRANCO NEVE BRANCO NEVE
01	AGL04.01.00	Base Inferior/Base/Shelf	1200x300x15	01	269025	277420
02	AGL04.05.00	Base superior/Base superior/Shelf	1200x300x15	01	269027	277422
03	AGL04.13.00	Forro/Revés/botton	1186x310x2.5	02	269024	269024
04	AGL04.17.00	Lateral externa direita/Lateral derecha/Right side	600x300x15	01	269028	277423
05	AGL04.18.00	Lateral externa esquerda/Lateral izquierda/Left side	600x300x15	01	269029	277424
06	AGL04.19.00	Lateral interna/Lateral interna/Inner side	600x300x15	01	271054	277425
07	AGL04.02.00	Base interna/Base/Shelf	795x280x15	01	269026	277421
08	AGL04.25.00	Porta/Puerta/Door	592x392x15	02	269031	277426
09	AGL04.25.01	Porta/Puerta/Door	592x352x15	01	269032	277427

Ferragens/Herrajes/Hardware

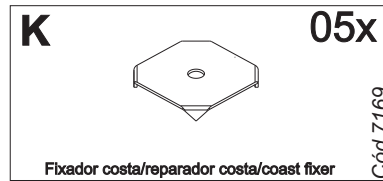
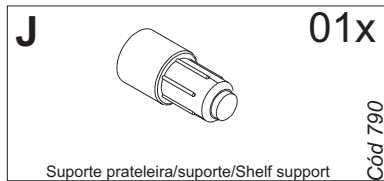
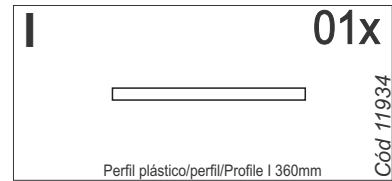
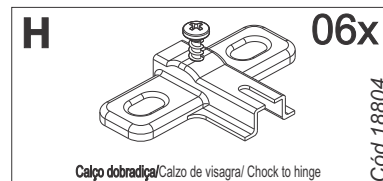
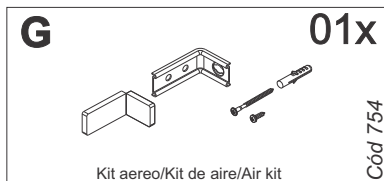
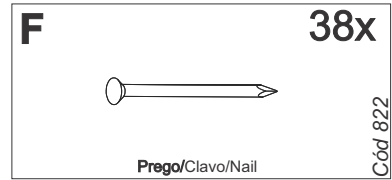
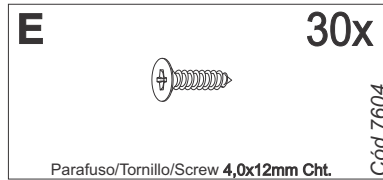
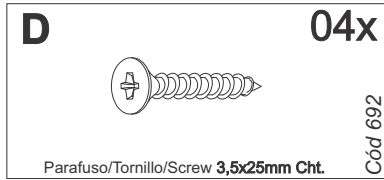
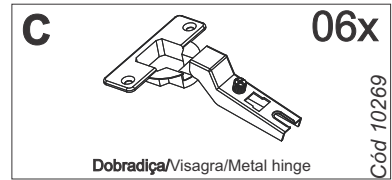
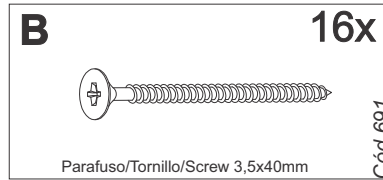
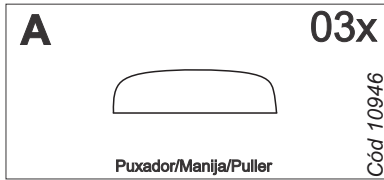

Obs: a régua serve para medição da ferragem.
Nota: la regla se utiliza para medir el hardware.
Note: the ruler is used to measure the hardware.



Medidas em mm
Measures in mm
Mesuras en mm



*Usar os parafusos (D) para unir este módulo a outro.
Usar los tornillos (D) para unirse este modulo a otro.
Use the screws (D) to join this module to another.



Pré-Montagem/Preparación Piezas/ Pre-assembly

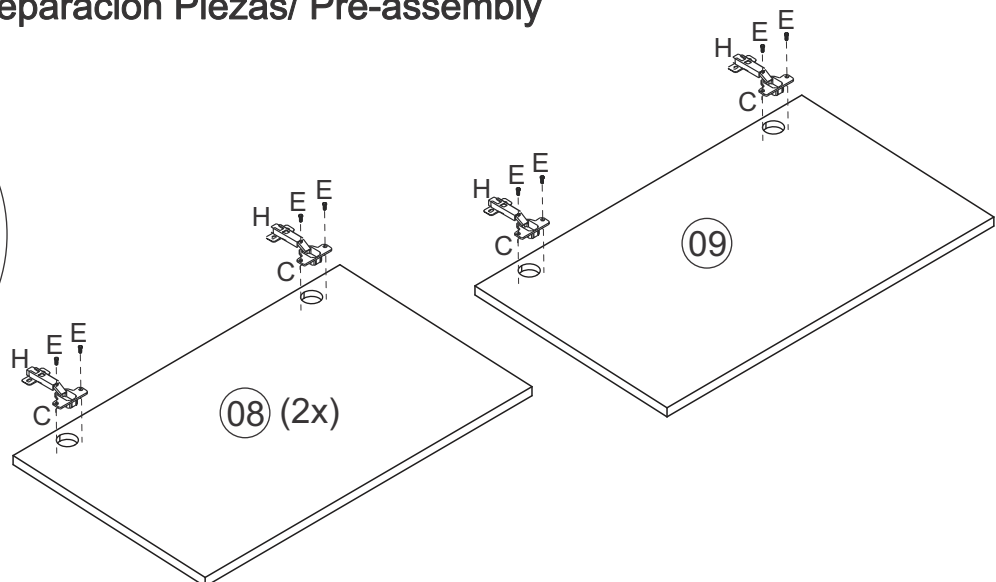
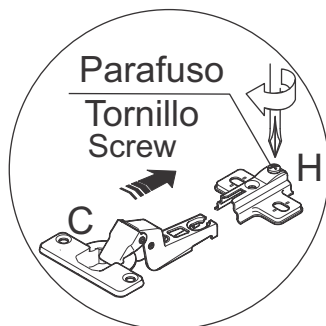

01 Montagem/Montaje/Assembly

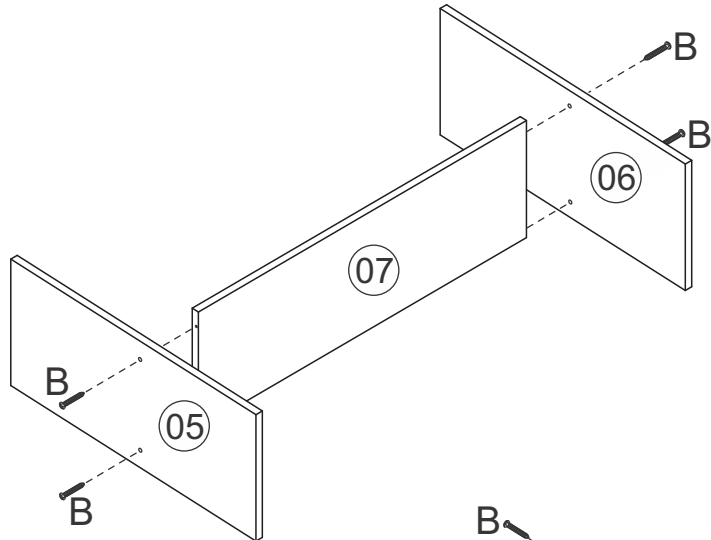

02

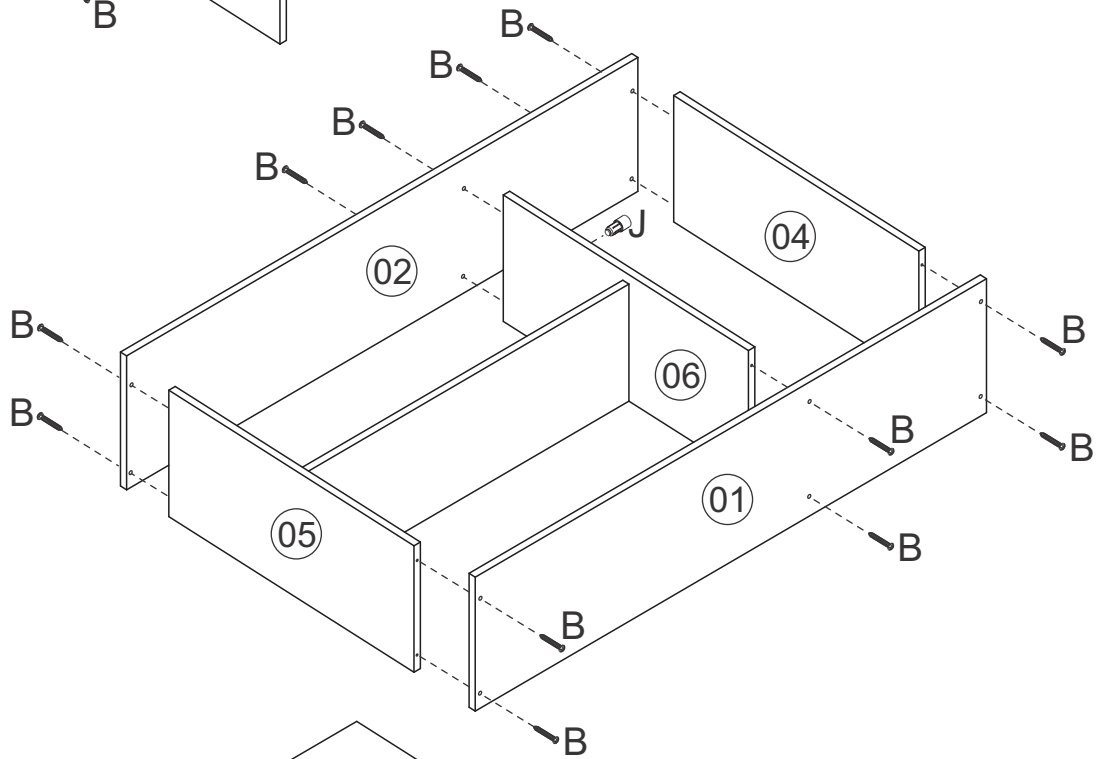

03

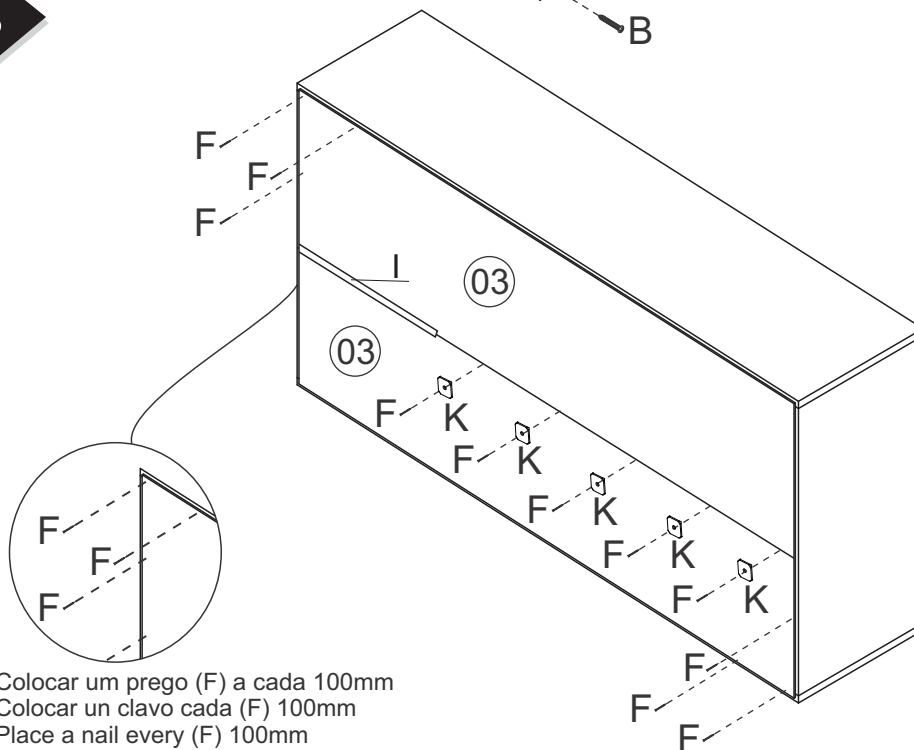

- *Colocar um prego (F) a cada 100mm
- *Colocar un clavo cada (F) 100mm
- *Place a nail every (F) 100mm

01 Montagem/Montaje/Assembly

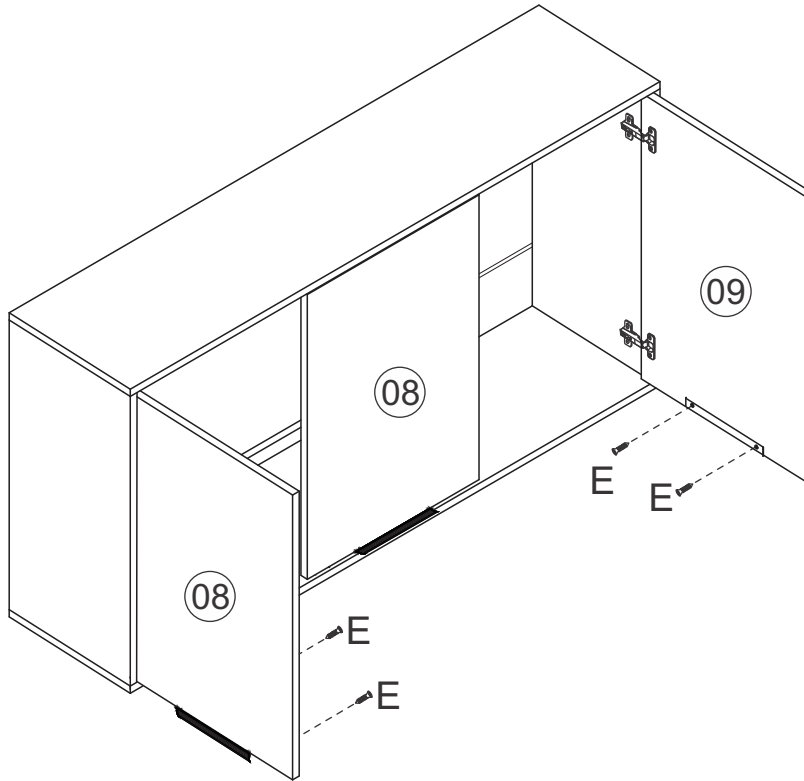

Fixação na parede
Fijación en la pared
Wall mounting

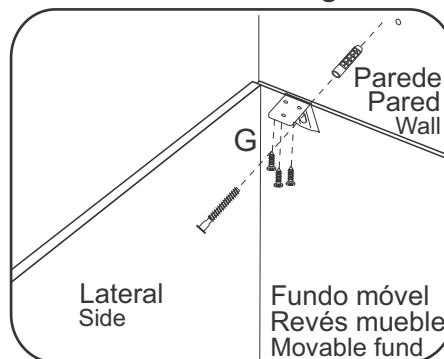

*Fixar a cantoneira na parte interna do móvel.
Fijar la pieza «G» en el interior del mueble.
Attach an angle bracket to the inside of the furniture.

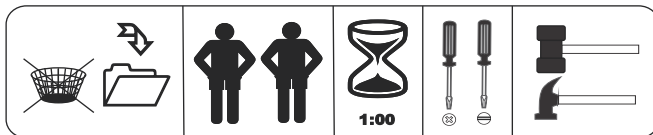

Limpeza/Limpieza

- ≠ Use um pano levemente umedecido com água, seguido de pano seco.
- ≠ Use solamente un paño húmedo con agua y después un paño seco.
- ≠ Use a cloth slightly dampened with water, followed by a dry cloth.
- ≠ Nunca utilize produtos químicos ou abrasivos.
- ≠ No utilize productos químicos o abrasivos.
- ≠ Never use chemical or abrasive products.

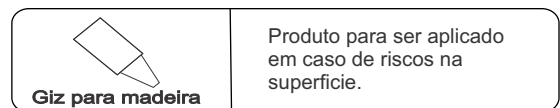

Produto para ser aplicado em caso de riscos na superfície.

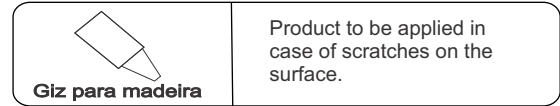

Product to be applied in case of scratches on the surface.

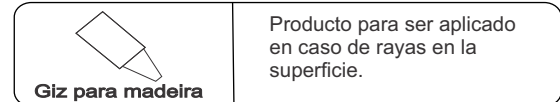

Producto para ser aplicado en caso de rayas en la superficie.



Rodovia SC-492 - Km 10 - B. Industrial
89905-000 - Bandeirante - SC
Fone: (49) 3622-4549
e-mail: mxmoveis@mxmoveis.com.br

Ref. BGL02

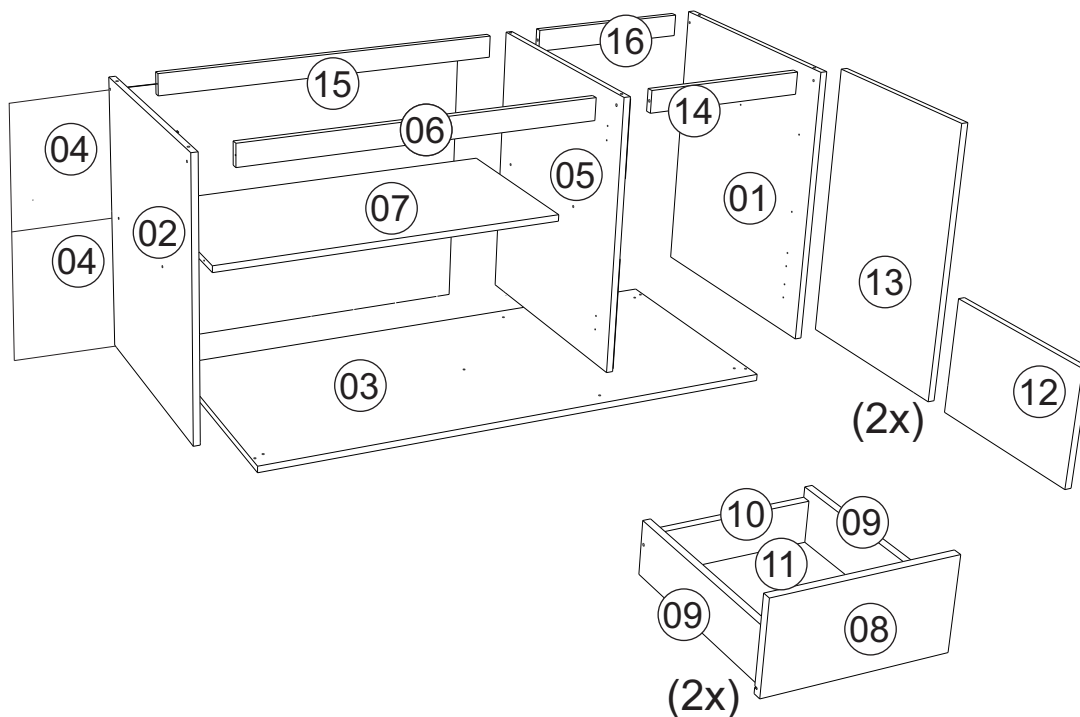
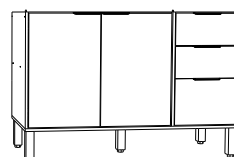

Balcão 1200 2P 3G
Balcón 1200
Counter 1200
Cozinha/Cocina
GLORIA



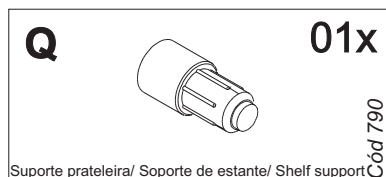
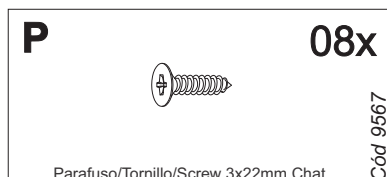
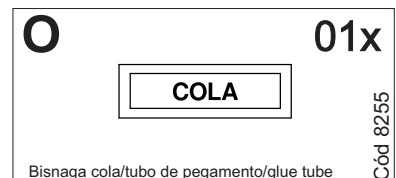
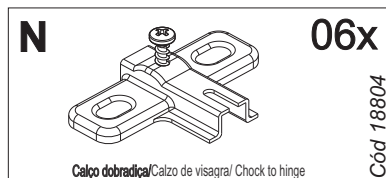
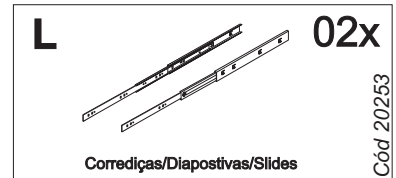
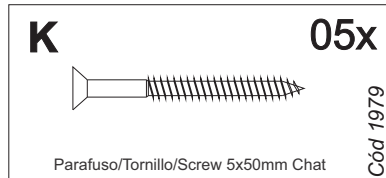
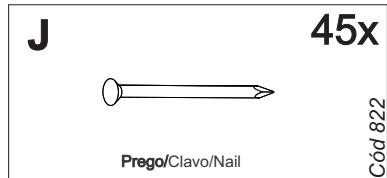
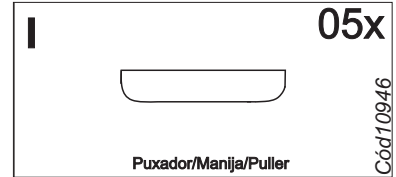
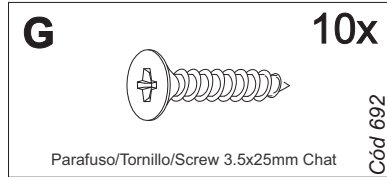
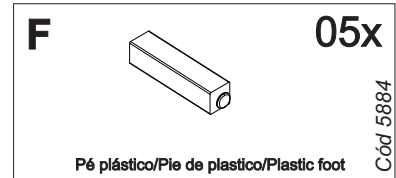
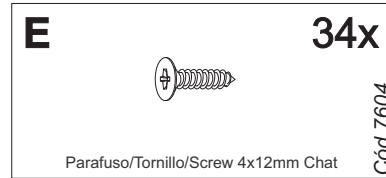
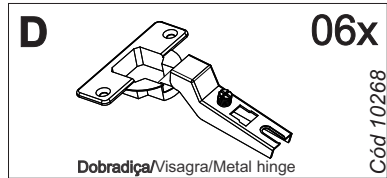
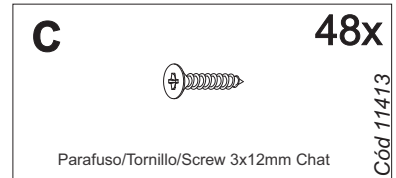
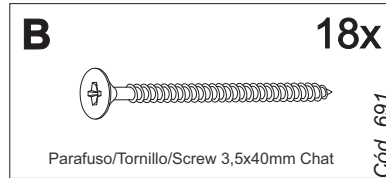
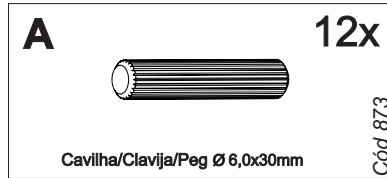

Nº	CÓDIGO CODE ASSISTÊNCIA ATTENDANCE	NOME DA PEÇA/DESCRIPCIÓN PIEZAS/DESCRIPTION PARTS	MEDIDAS (mm) MEASURES (mm)	QTD.	CASTANHO CASTANHO	BRANCO NEVE BRANCO NEVE
01	BGL02.17.00	Lateral externa direita/Lateral derecha/Right side	625x516x15	01	263565	277514
02	BGL02.18.00	Lateral externa esquerda/Lateral izquierda/Left side	625x516x15	01	263785	277515
03	BGL02.01.00	Base inferior/Base/Shelf	1200x516x15	01	263564	277512
04	BGL02.13.00	Forro/Revés/botton	1186x300x2.5	02	260772	260772
05	BGL02.19.00	Lateral interna/Lateral interna/Inner side	625x516x15	01	264561	277516
06	BGL02.28.00	Ripa sustentação frontal /Travesaño/front support slat	795x50x15	01	263568	277519
07	BGL02.02.00	Base interna/Base pequena/Shelf	795x387x15	01	261607	261607
08	BGL02.14.00	Frente gaveta/Frente cajón/Drawer front	352x175x15	02	260905	277513
09	BGL02.15.00	Lateral gaveta/Lateral cajón/ Drawer side	350x100x15	04	260777	260777
10	BGL02.29.00	Ripa Traseira de gaveta/Trasero cajón/Drawer back	306x80x15	02	260785	260785
11	BGL02.34.00	Forro gaveta/Revés cajón/Botton	355x336x15	02	260773	260773
12	BGL02.25.01	Porta/Puerta/Door	352x255x15	01	260910	277518
13	BGL02.25.00	Porta/Puerta/Door	615x392x15	02	260909	277517
14	BGL02.28.02	Ripa sustentação frontal /Travesaño/front support slat	360x50x15	01	263786	277520
15	BGL02.28.01	Ripa sustentação /Travesaño/Rear support slat	795x50x15	01	260784	260784
16	BGL02.28.03	Ripa sustentação /Travesaño/Rear support slat	360x50x15	01	263787	263787

Ferragens/Herrajes/Hardware



 *Usar os parafusos (G) para unir este módulo a outro. 
 Usar los tornillos (G) para unirse este módulo a otro.
 Use the screws (G) to join this module to another.

 *** Em caso de aquisição do tampo e roda tampo ***
 Este kit de ferragem possui 08 unidades a mais do parafuso (C) e 4 unidades do item (H). 



Medidas em mm
 Measures in mm
 Medidas en mm

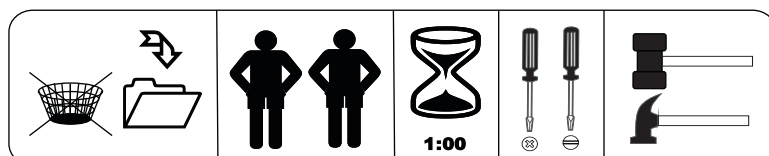

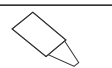
 **Giz para madeira** Produto para ser aplicado em caso de riscos na superfície.

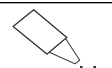
 **Giz para madeira** Product to be applied in case of scratches on the surface.

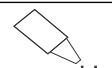
 **Giz para madeira** Producto para ser aplicado en caso de rayas en la superficie.

Pré-Montagem/Preparación Piezas/ Pre-assembly

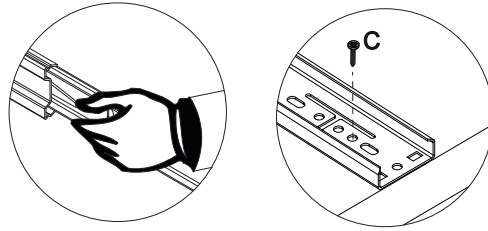

Soltar as partes da correição
 Afloje las piezas deslizantes
 Loosen the slide parts

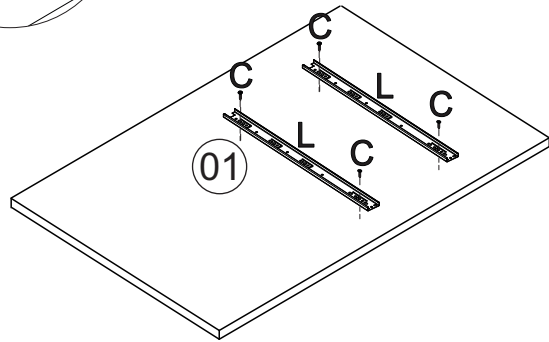

OBS: As correições telescópicas na lateral interna do balcão são fixadas, após a união da lateral interna com a base interna.

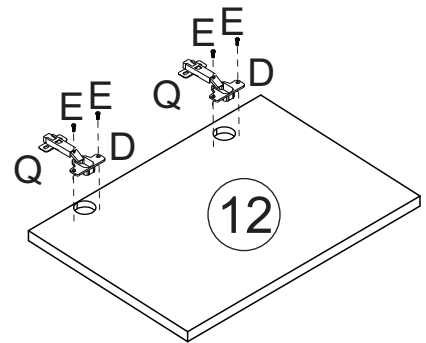
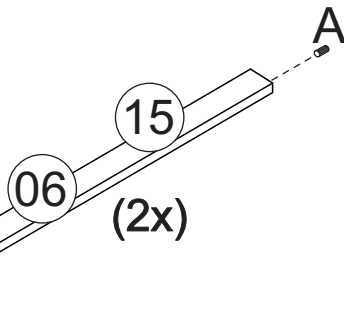
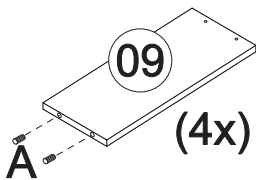
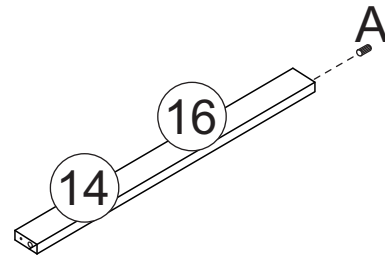

Utilizar cola nas cavilhas
 Usa pegamento en los tacos.
 Use glue on the dowels

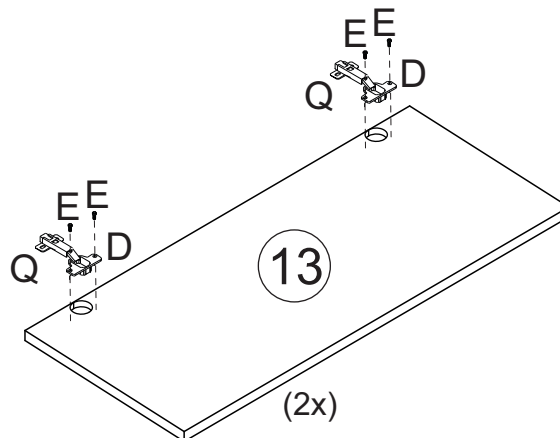

01 Montagem/Montaje/Assembly

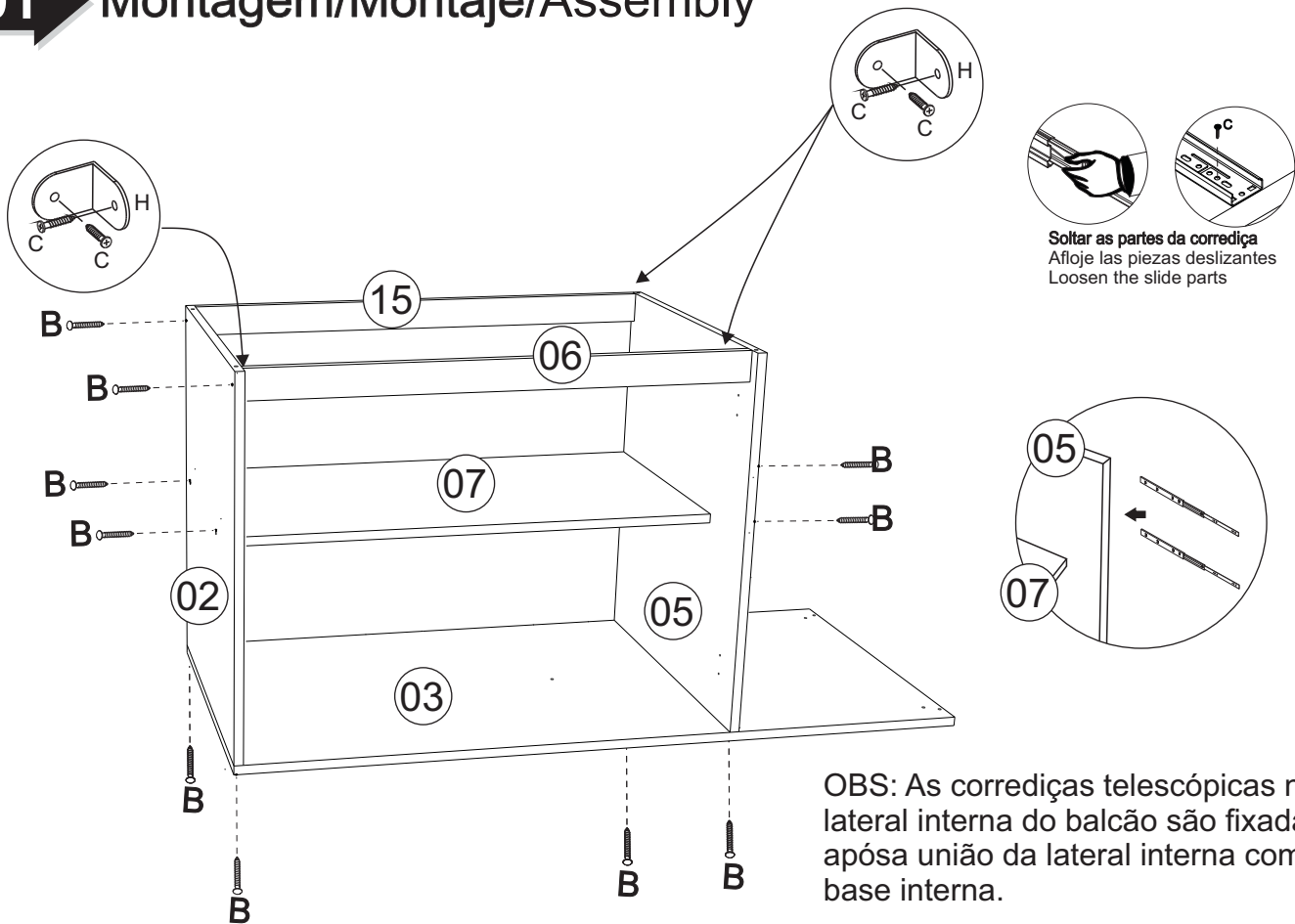

02 Montagem/Montaje/Assembly

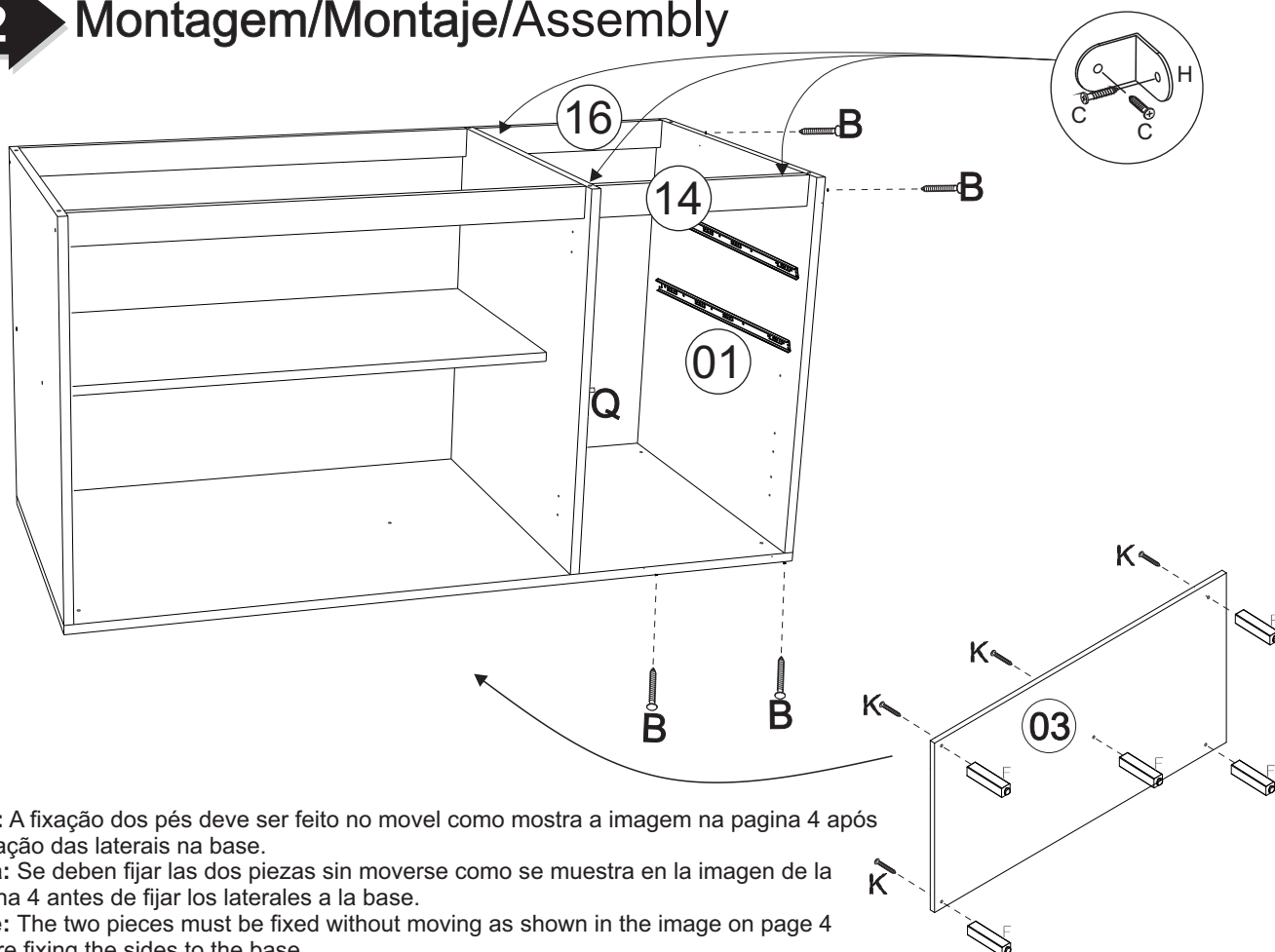

03 Montagem/Montaje/Assembly

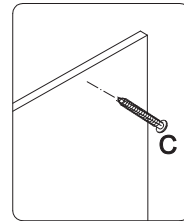
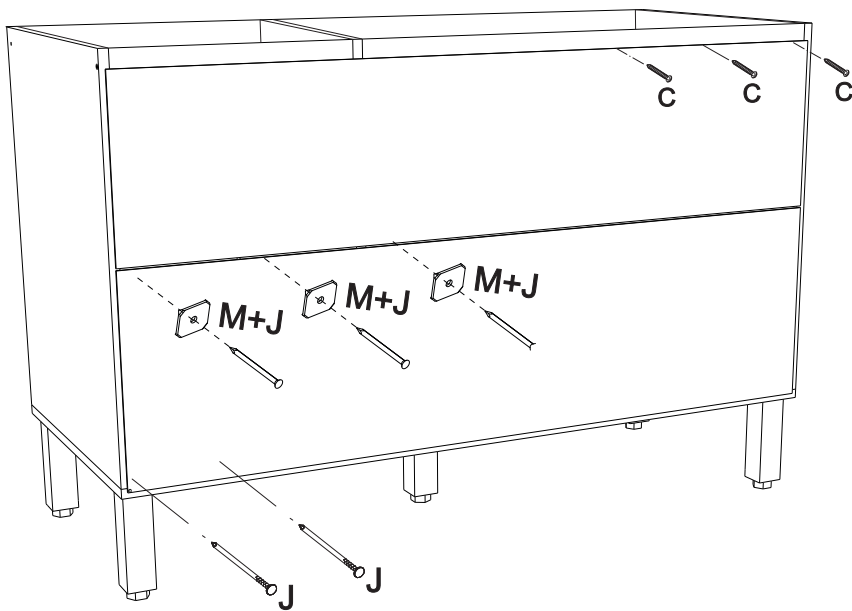

*Colocar um parafuso (C) a cada 100mm
*Colocar un tornillo (C) cada 100mm
*Place a screw (C) every 100mm

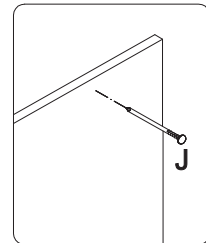

*Colocar um prego (J) a cada 100mm
*Colocar un clavo cada (J) 100mm
*Place a nail every (J) 100mm

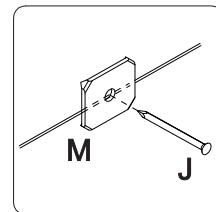

*Usar o prego (J) e a junção (M) a cada 100mm
*Usar el clavo (J) y la junta (M) cada 100mm
*Use the nail (J) and the joint (M) every 100mm

04 Montagem/Montaje/Assembly

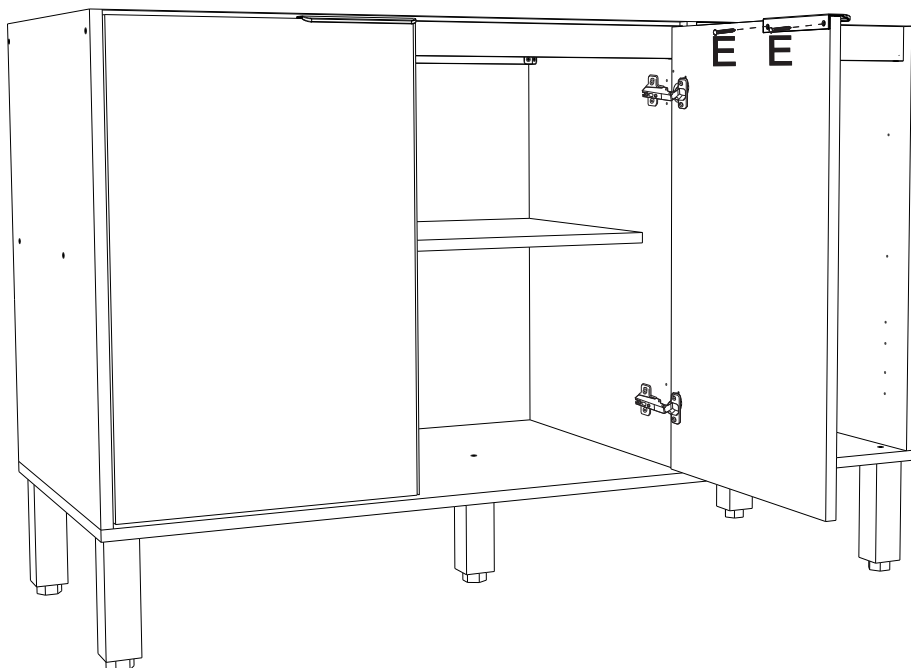

05 Montagem/Montaje/Assembly

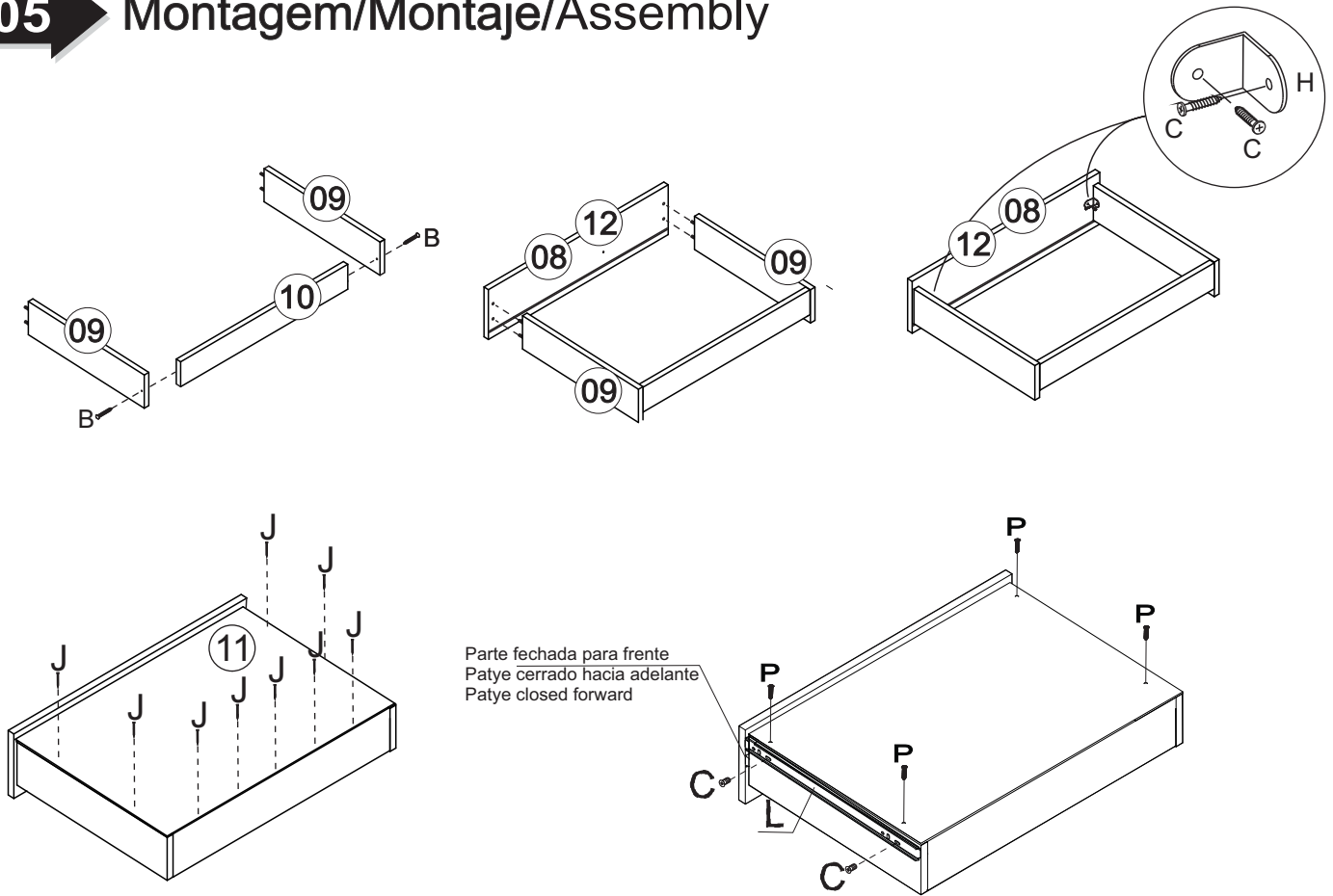

06 Montagem/Montaje/Assembly

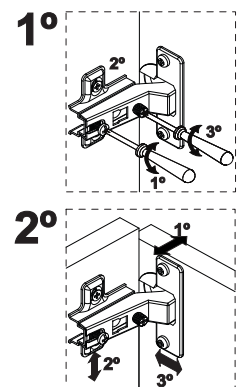
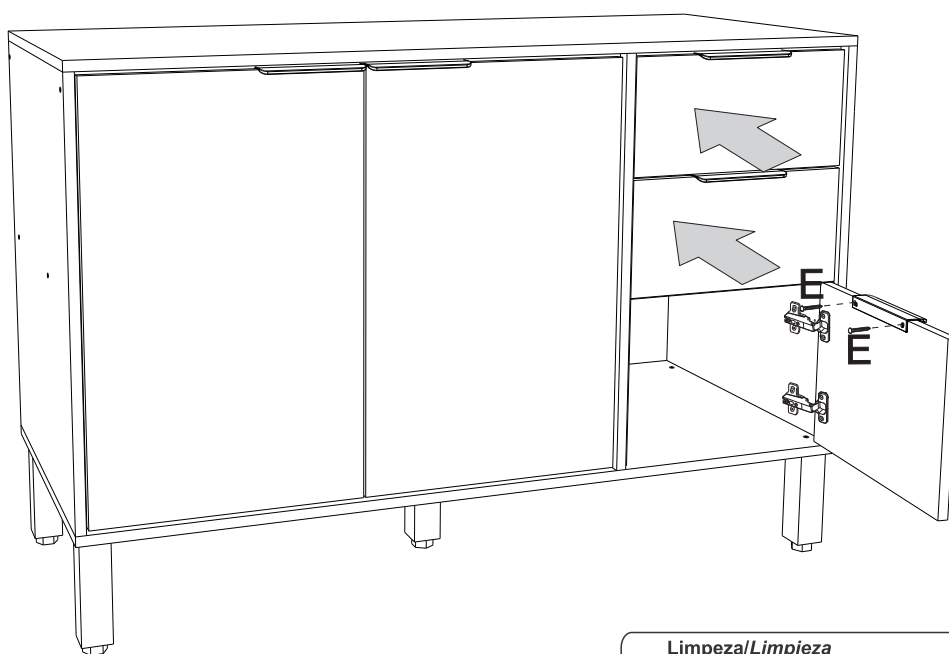

Limpeza/Limpieza

- ≠ Use um pano levemente umedecido com água, seguido de pano seco.
- ≠ Use solamente un paño húmedo con agua y después un paño seco.
- ≠ Use a cloth slightly dampened with water, followed by a dry cloth.
- ≠ Nunca utilize produtos químicos ou abrasivos.
- ≠ No utilice productos químicos o abrasivos.
- ≠ Never use chemical or abrasive products.



Rodovia SC-492 - Km 10 - B. Industrial
 89905-000 - Bandeirante - SC
 Fone: (49) 3622-4549
 e-mail: mxmoveis@mxmoveis.com.br

Ref. AGL01

Aéreo 800 Basic
Armario 800
Air 800
Cozinha/Cocina
GLORIA

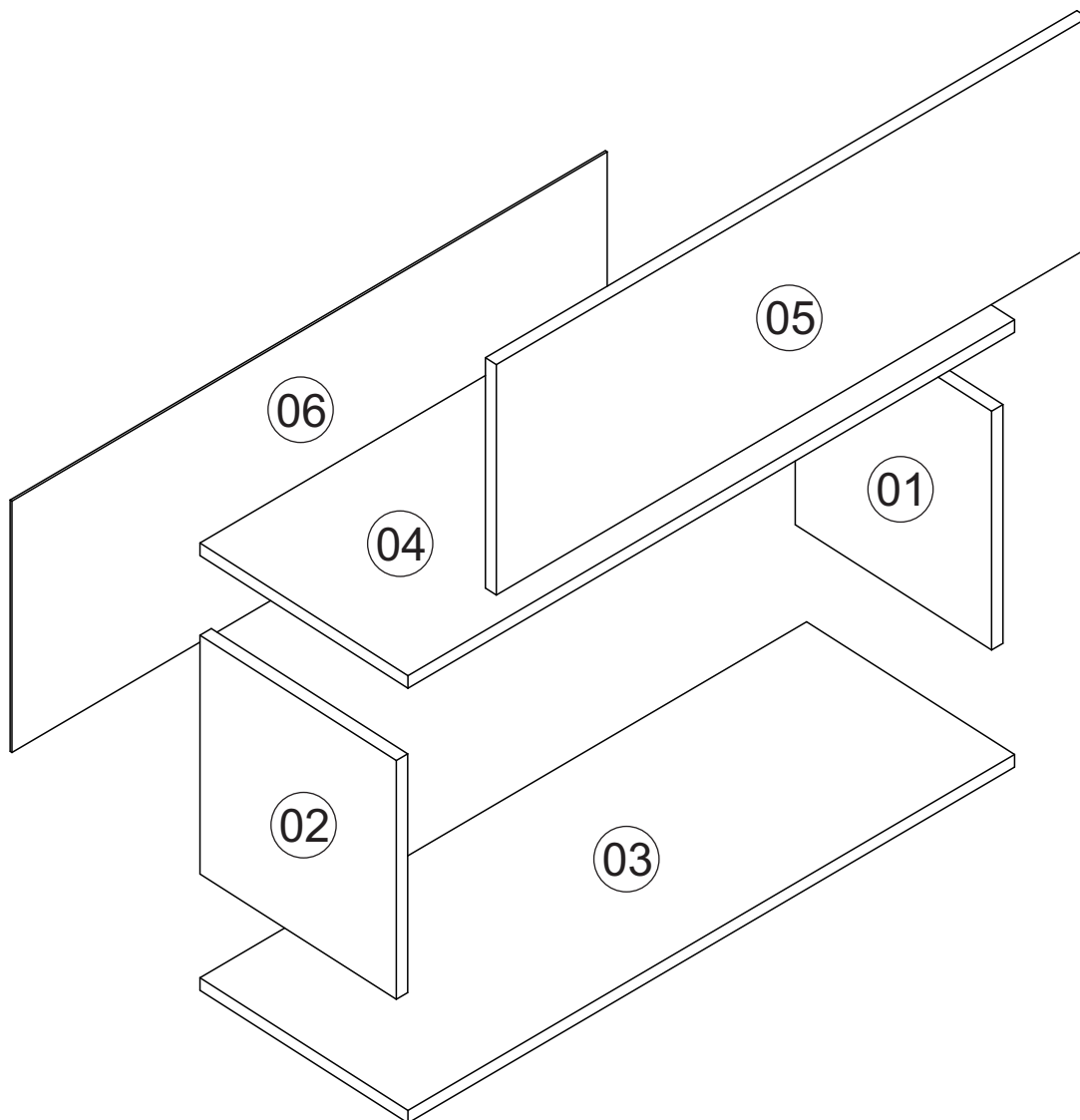
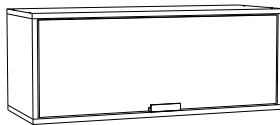

Nº	CÓDIGO ASSISTÊNCIA CODE ATTENDANCE	NOME DA PEÇA/DESCRIPCIÓN PIEZAS/DESCRIPTION PARTS	MEDIDAS (mm) MEASURES (mm)	QTD.	CASTANHO CASTANHO	BRANCO NEVE BRANCO NEVE
01	AGL01.17.00	Lateral externa direita/Lateral derecha/Right side	285x300x15	01	263410	277378
02	AGL01.18.00	Lateral externa esquerda/Lateral izquierda/Left side	285x300x15	01	263374	277379
03	AGL01.01.00	Base Inferior/Base/Shelf	800x300x15	01	263371	277376
04	AGL01.05.00	Base superior/Base superior/Shelf	800x300x15	01	263372	277377
05	AGL01.25.00	Porta/Puerta/Door	762x277x15	01	263375	277380
06	AGL01.13.00	Forro/Revés/botton	786x301x2.5	01	260547	260547

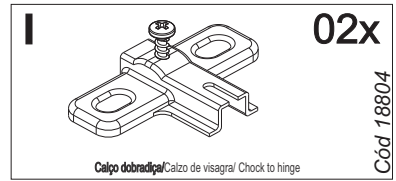
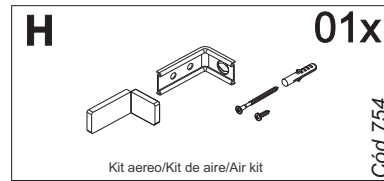
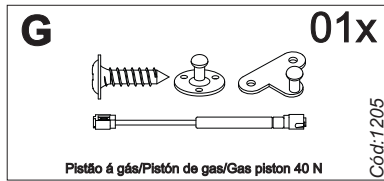
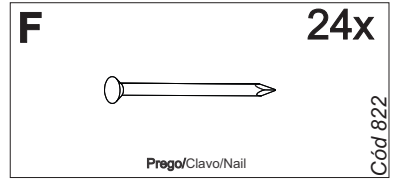
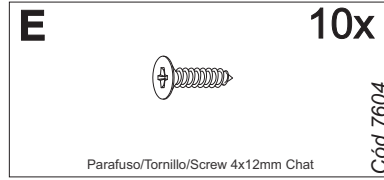
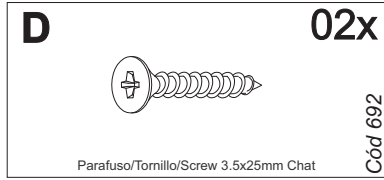
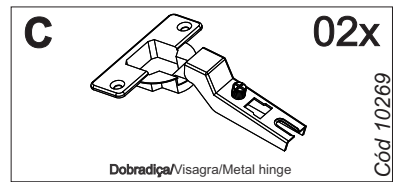
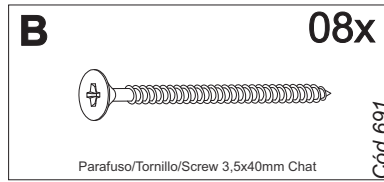
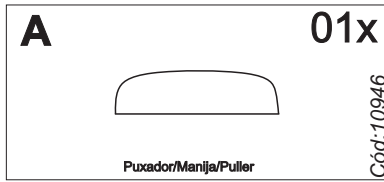

Ferragens/Herrajes/Hardware

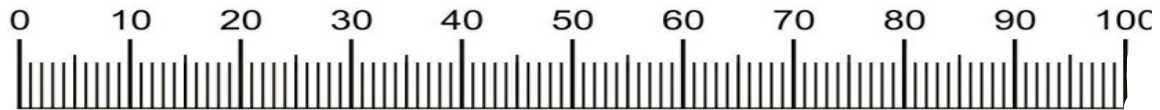

Obs: a régua serve para medição da ferragem.
Nota: la regla se utiliza para medir el hardware.
Note: the ruler is used to measure the hardware.



Medidas em mm
Measures in mm
Mesuras en mm

	Produto para ser aplicado em caso de riscos na superfície.
	Product to be applied in case of scratches on the surface.
	Producto para ser aplicado en caso de rayas en la superficie.

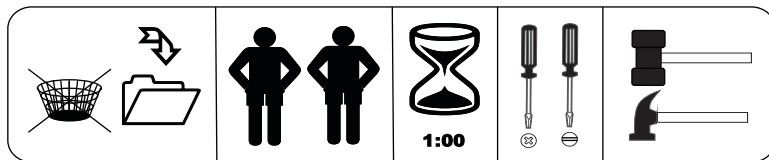

*Usar os parafusos (D) para unir este módulo a outro.
Usar los tornillos (D) para unirse este modulo a otro.
Use the screws (D) to join this module to another.



Pré-Montagem/Preparación Piezas/ Pre-assembly

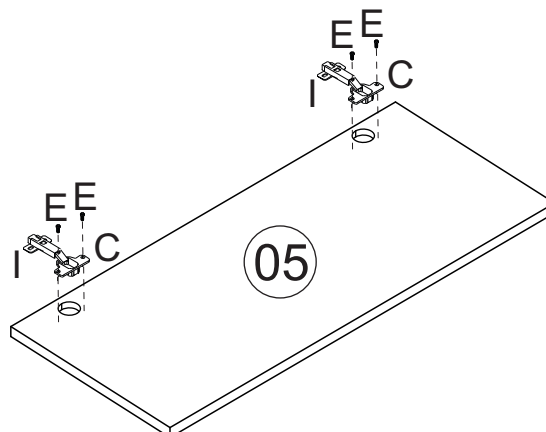

01 Montagem/Montaje/Assembly

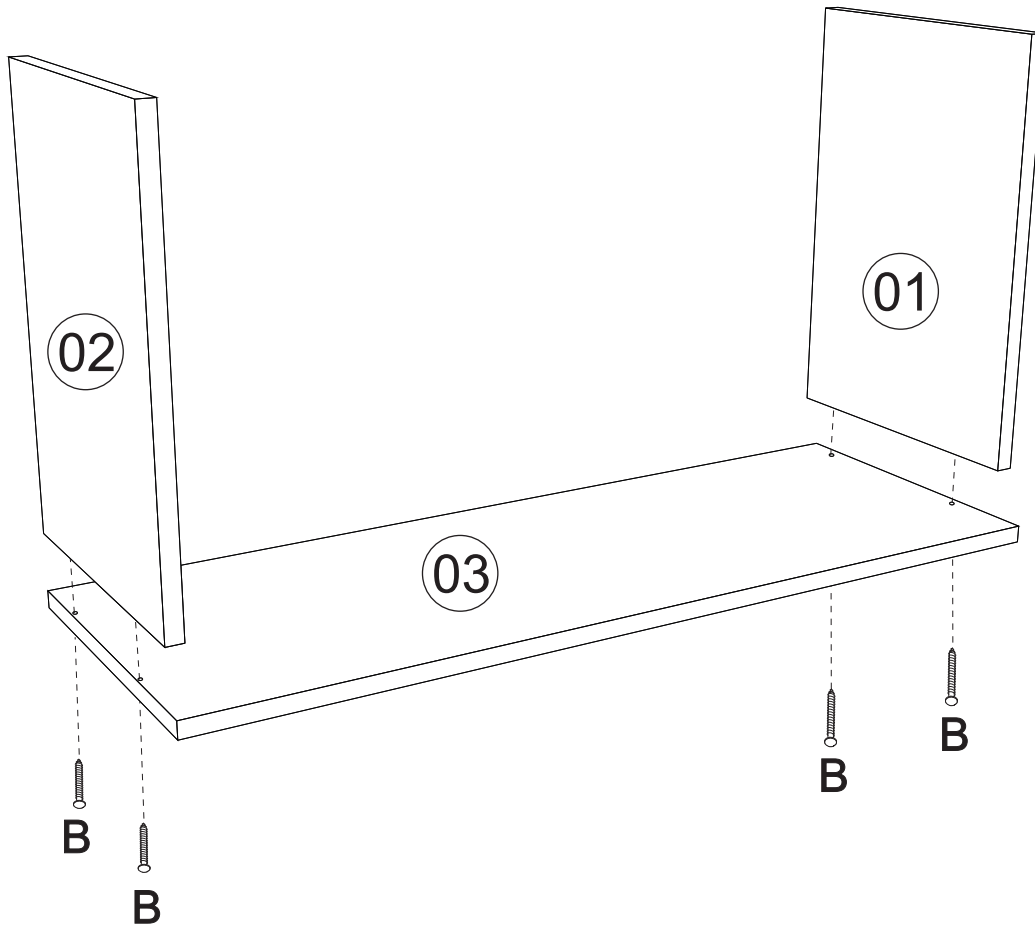

02 Montagem/Montaje/Assembly

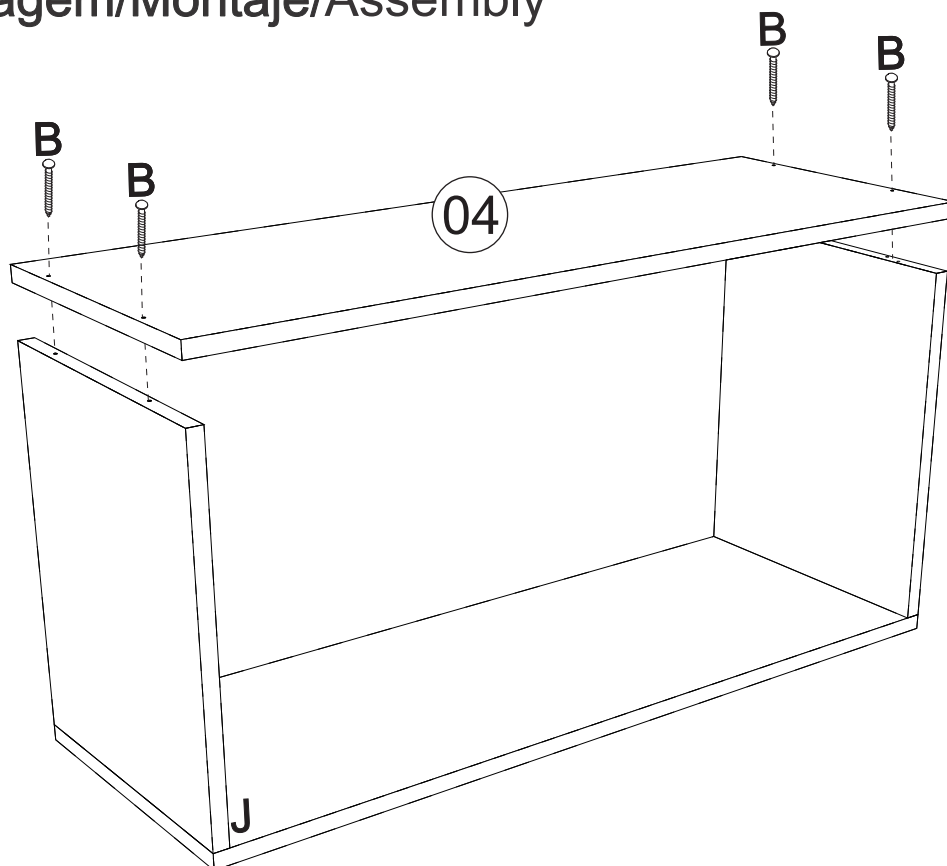

03 Montagem/Montaje/Assembly

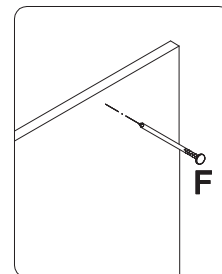
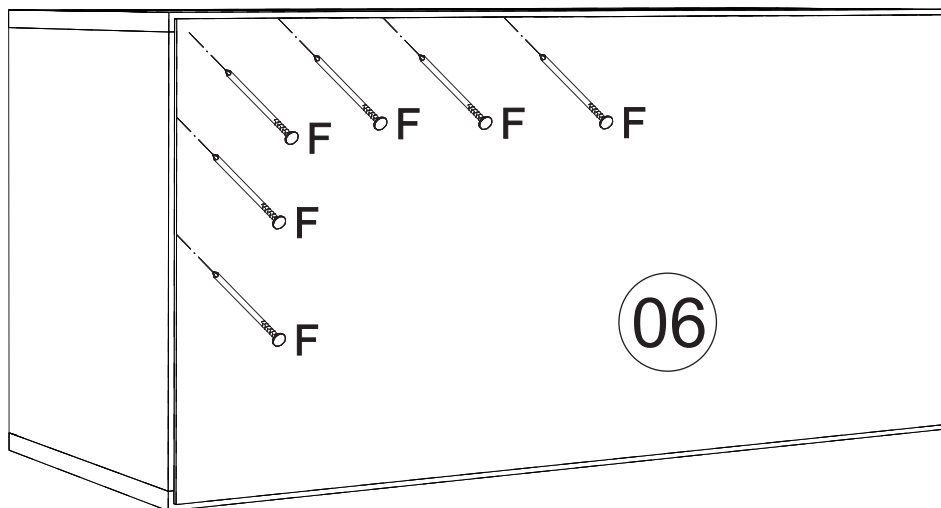

- *Colocar um prego (F) a cada 100mm
- *Colocar un clavo cada (F) 100mm
- *Place a nail every (F) 100mm

04 Montagem/Montaje/Assembly

Obs: Centralizar o puxador na porta.
 Nota: Centre la manija en la puerta.
 Note: Center the handle on the door.

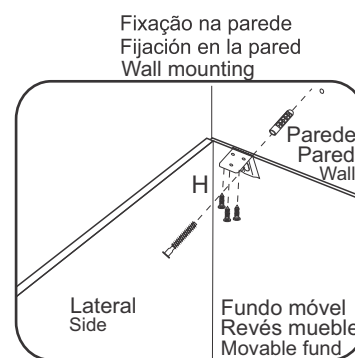
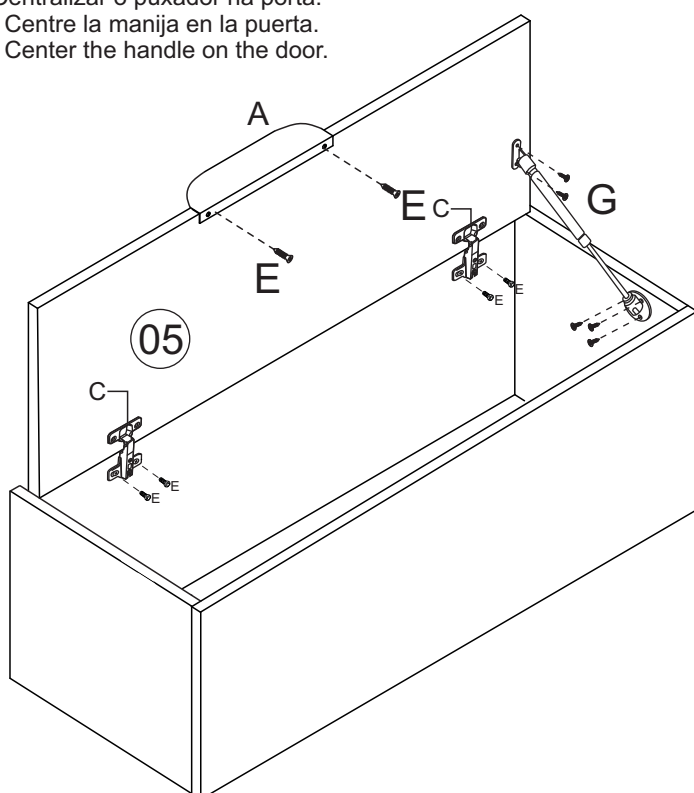

- *Fixar a cantoneira na parte interna do móvel.
- *Fijar la pieza «H» en el interior del mueble.
- *Attach the corner bracket to the inside of the furniture.

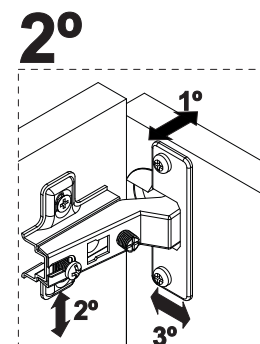
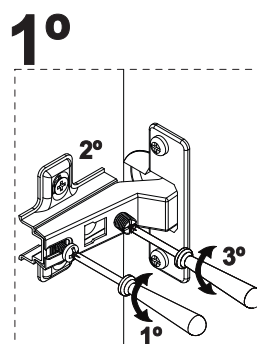

Agora que você já comprou o seu móvel, ele merece ser montado do jeito certo.

Erros de montagem causam mais de **60%** dos danos em móveis.

Por que contratar?

Tranquilidade do **início ao fim** da montagem



PROFISSIONAIS QUALIFICADOS

Especialistas certificados na **MadeiraMadeira Serviços**.



FERRAMENTAS PROFISSIONAIS

que **protegem** seus móveis.



AGENDAMENTO EM 24 HORAS

escolha a data e o turno **ideais para** você.



GARANTIA DE 3 MESES

de cobertura **completa**.

Mais de 1 MILHÃO DE MONTAGENS
★ com avaliação 4.7 ★

Mariana S., São Paulo

"Chegaram no horário e montaram tudo rapidamente. Serviço incrível!"



Carlos R., Belo Horizonte

"Tentei montar sozinho e foi um desastre. Com a **MadeiraMadeira Serviços** ficou perfeito."



Ana P., Rio de Janeiro

"Agendamento ágil e **montagem pontual e perfeita**. Recomendo demais!"



Agende agora pelo QR Code

Madeira**Madeira** Serviços · Atendimento em todo o Brasil



Escaneie o QRCode