

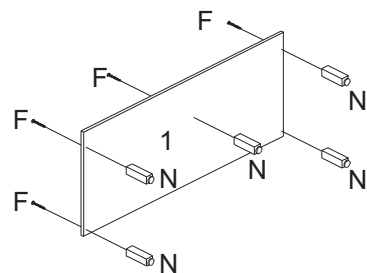











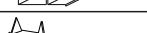

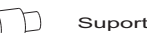

1° Passo



FERRAGENS

A		Parafuso 4 x 50
B		Prego 10 x 10
C		Puxador
D		Fixador de Fundo
E		Parafuso 3,5 x 25
F		Parafuso 4 x 40
G		Suporte Prateleira Movel
H		Parafuso 4,5 x 25
I		Dobradiça
J		Parafuso 3,5 x 14
K		Cantoneira
L		Cavilha
M		Corrediça telescópicas
N		Pés
O		Perfil h

2° Passo

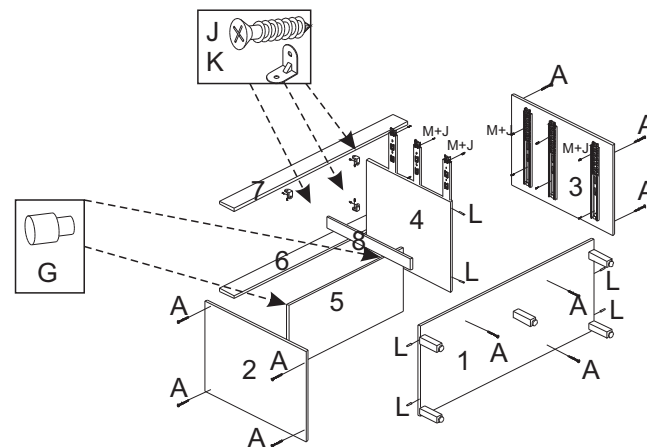

3° Passo

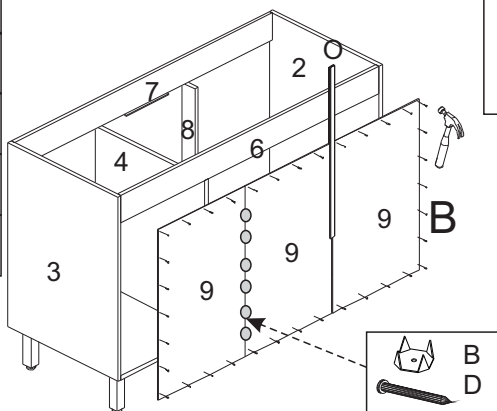

4° Passo

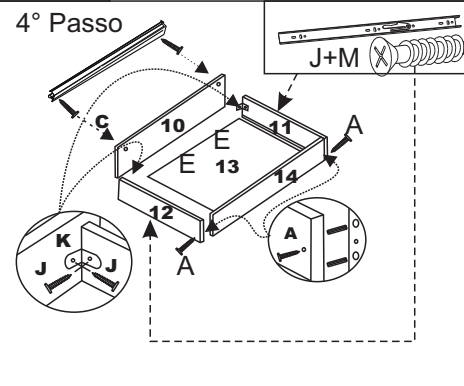

5° Passo

