

MANUAL DE MONTAGEM - GABINETE CP

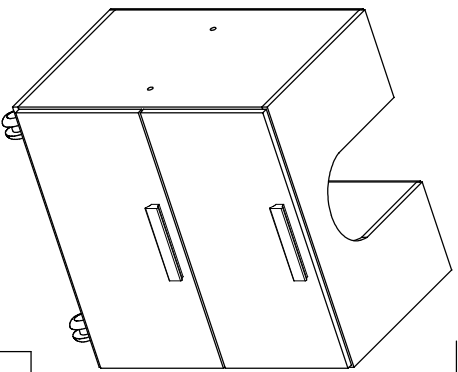

ATENÇÃO SR. MONTADOR: LEIA ATENTAMENTE ESTE MANUAL ANTES DE INICIAR A MONTAGEM. GUARDAR PARA EVENTUAIS CONSULTAS.

DIMENSÃO		
ALTURA	LARG.	PROF.
620 MM	540 MM	380 MM

LEGENDA

Nº	PEÇA	QTDE	COMPR.	LARG.	ESPESS.
01	TAMPO	01	540	350	12 MM
02	LATERAL ESQUERDA	01	537	350	12 MM
03	LATERAL DIREITA	01	537	350	12 MM
04	PRATELEIRA	01	515	350	12 MM
05	BASE	01	540	350	12 MM
06	FUNDO TRASEIRO	02	555	182	03 MM
07	PORTA	02	530	270	12 MM

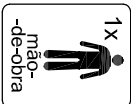
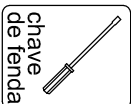
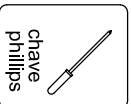
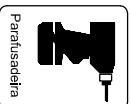

KIT ACESSÓRIOS

DESCRIÇÃO	APLICAÇÃO	ILUSTRAÇÃO
PARAFUSO 3,5 X 35 CH. PHS	BASE/ PRATELEIRA	
PARAFUSO 3,5 X 25 CH. PHS	PUXADOR	
PARAFUSO 3,5 X 12 CH. PHS	DOBRADIÇA E CALÇÓ/ CANTONEIRA	
PREGO	FUNDOS	
CAVILHA 6,0 X 30	LATERAL/ PRATELEIRA	
DOBRADIÇA PRESSÃO	PORTA	
CANTONEIRA METÁLICA 2 FUROS	TAMPO	
SACHÊ DE COLA	MONTAGEM (CAVILHA)	

NOTA IMPORTANTE

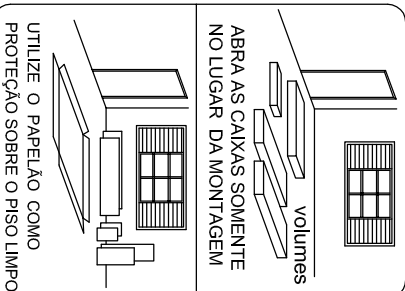

INÍCIO

1º PASSO

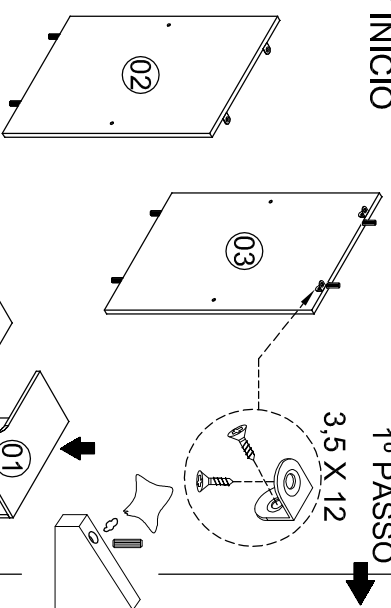

2º PASSO

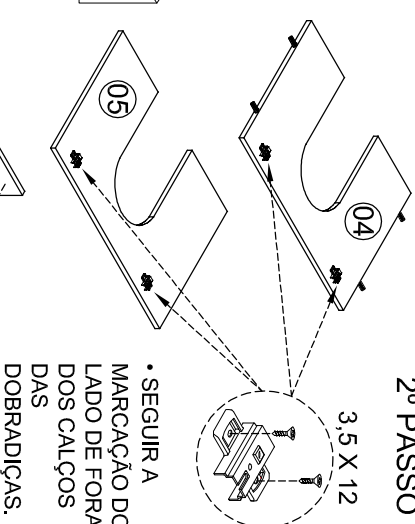

• FIXAR PRIMEIRAMENTE O TAMPO Nº01 NAS LATERAIS Nº02 E Nº03 COM CANTONEIRAS E CAVILHAS 6,0 X 30.

3º PASSO

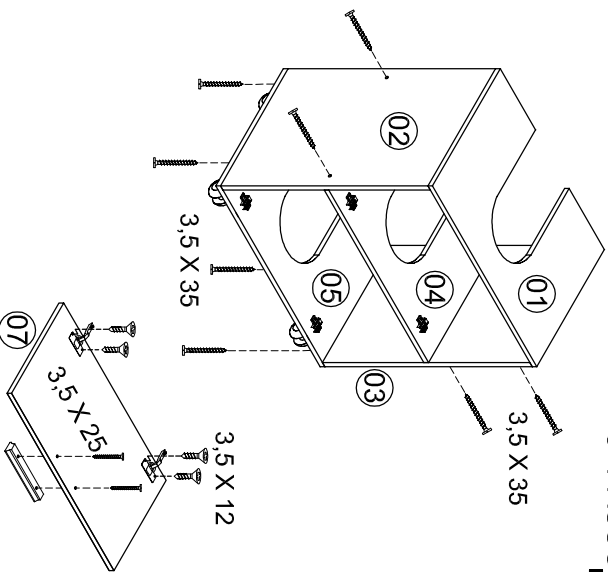

4º PASSO

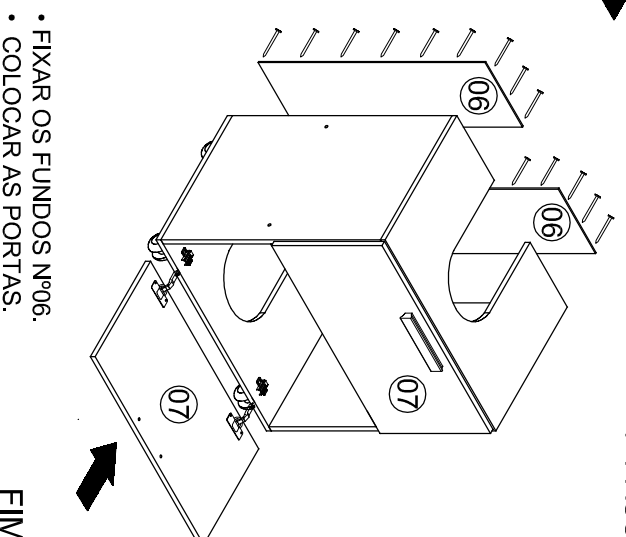

• FIXAR OS FUNDOS Nº06.
• COLOCAR AS PORTAS.

FIM