

Capacidade de Carga - Load Capacity - Capacidad de carga

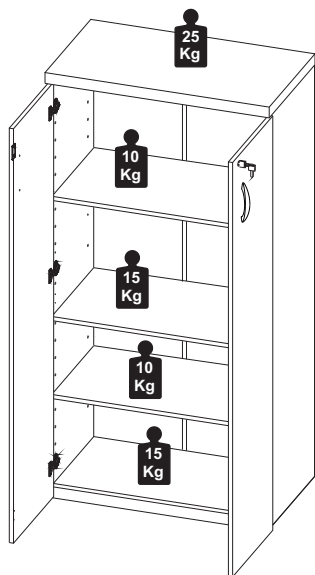

Manutenção e Limpeza

Vidros: pano levemente umedecido com álcool, seguido de pano seco.
Madeiras: pano levemente umedecido com água, seguido de pano seco.
*Nunca utilizar produtos químicos ou abrasivos.

Maintenance and Cleaning

Glasses: cloth lightly moistened with alcohol, followed by dry cloth.
Woods: cloth slightly moistened with water, followed by cloth seo.
*Never use chemicals or abrasives.

Mantenimiento y Limpieza

Vidrios: legeramente humedecido con alcohol, seguido de un paño seco.
Madera: ligeramente humedecido con agua, seguido de un paño seco.
*No utilice nunca productos químicos o abrasivos.

INSTRUÇÕES DE MONTAGEM ASSEMBLY INSTRUCTIONS INSTRUCCIONES DE MONTAJE

ARMÁRIO ALTO HIGT CABINET ARMARIO ALTO

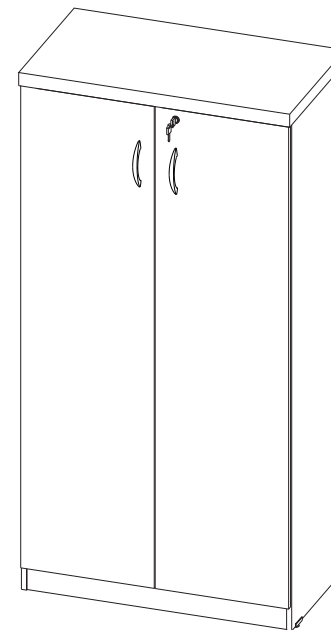

REF. #TEK-ATC8016



LISTA DE PEÇAS

- 01 - Lateral Esquerda
- 02 - Lateral Direita
- 03 - Tampo
- 04 - Base
- 05 - Prateleira
- 06 - Porta Esquerda
- 07 - Porta Direita
- 08 - Costa
- 09 - Rodapé

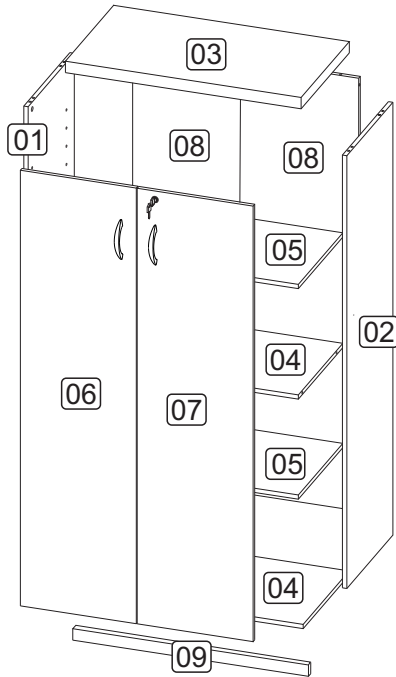

LISTA DE PIEZAS

- 01 - Lateral Izquierda
- 02 - Lateral Derecha
- 03 - Tapa
- 04 - Base
- 05 - Plataforma
- 06 - Puerta Izquierda
- 07 - Puerta Derecha
- 08 - Revés
- 09 - Pie

PARTS IDENTIFICATION

- 01 - Left Side
- 02 - Right Side
- 03 - Top
- 04 - Base
- 05 - Shelf
- 06 - Left Door
- 07 - Right Door
- 08 - Back
- 09 - Footer

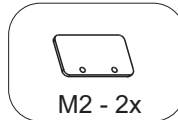
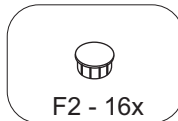
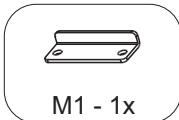
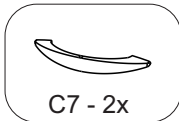
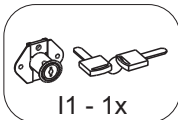
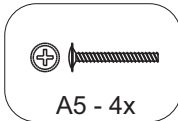
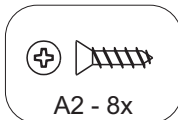
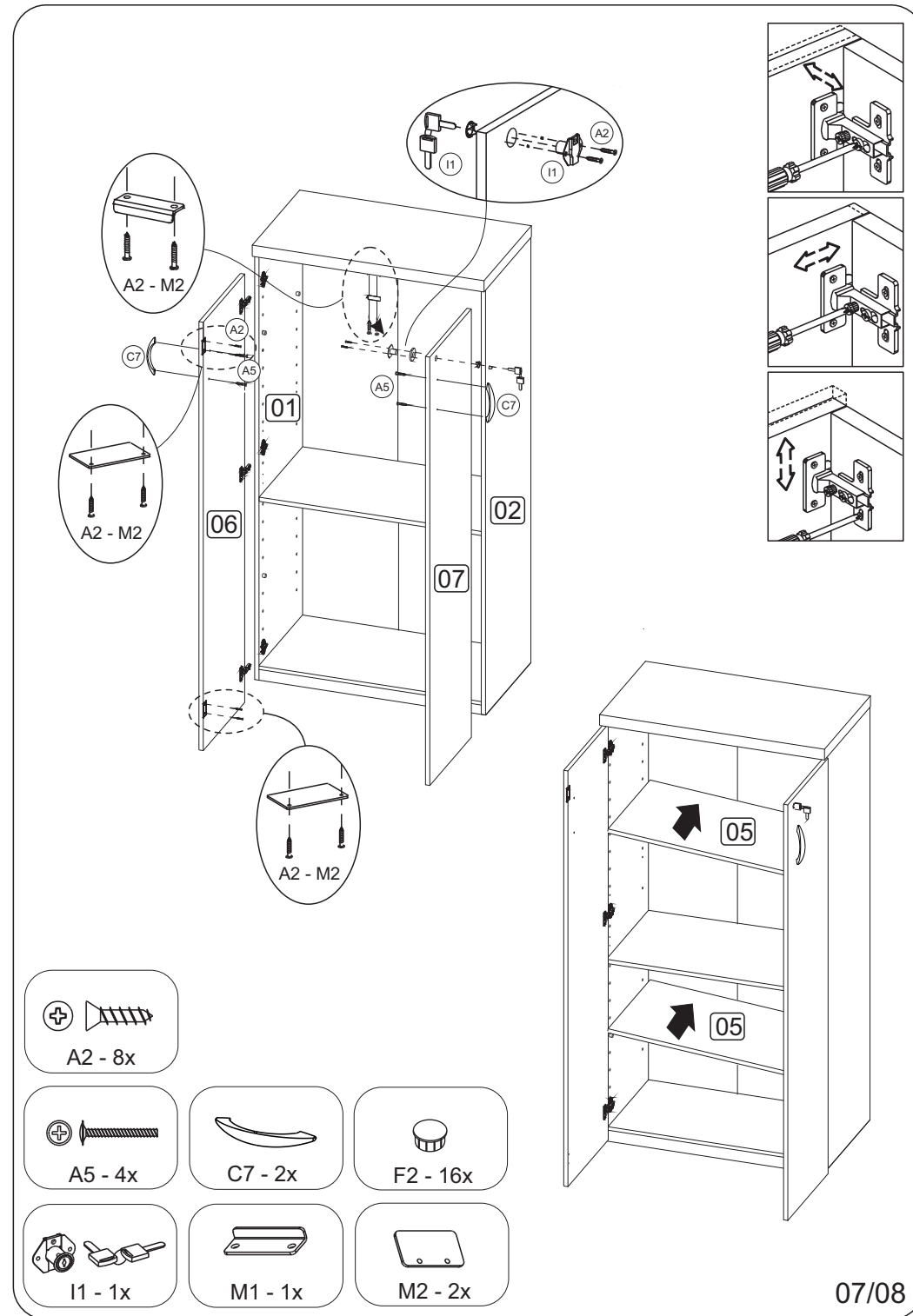

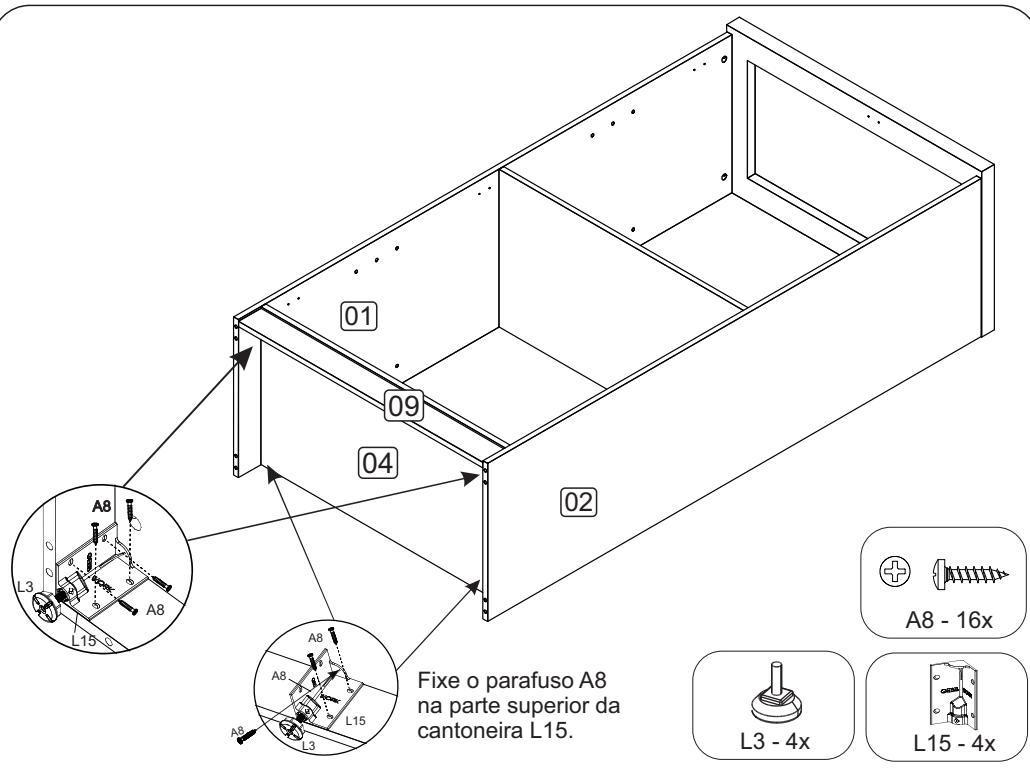

Fixe o parafuso A8 na parte superior da cantoneira L15.

L3 - 4x

L15 - 4x

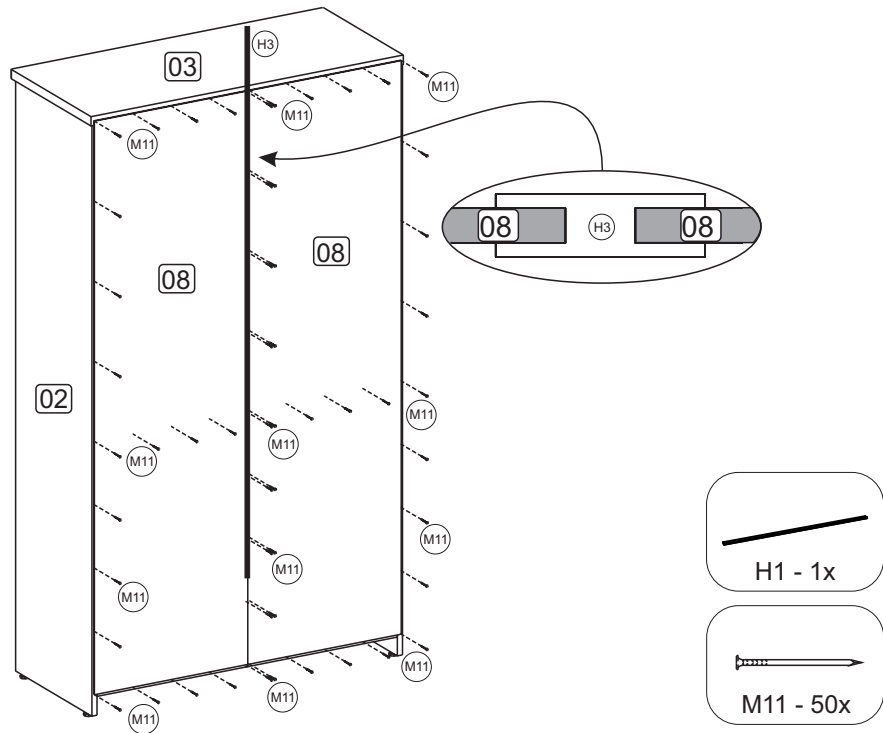

H1 - 1x

M11 - 50x

ACESSÓRIOS ACCESSORIES ACCESORIOS

A2 - PARAF. 3,5x14 CC
8x



A5 - PARAF. 3,5x25 CF
4x



A8 - PARAF. 4,0x14 CP
42x



A32 - PARAF. MINIFIX
12x

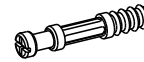

A35 - TAMBOR MINIFIX
12x



B2 - SUPORTE PRAT.
8x



C7 - PUXADOR
2x



D1 - CAVILHA 8x30
16x

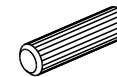

F1 - TAPA FURO ø18
4x



F2 - TAPA FURO ø8
16x



H1 - PERFIL PLÁST. H 1520MM
1x



I1 - FECHADURA P/GAV.
1x



G1 - DOBRADIÇA CANECO 35 BAIXO
6x

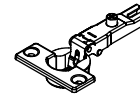

G2 - CALÇO ALTO P/ DOBRADIÇA
6x



L3 - SAPATA PLAST.1/4
4x



M1 - CHAPA L 2 FUROS OBL 42x17x0,9mm ZB
1x



M2 - BATENTE P/PORTA 2F 48x24x1,5mm ZB
2x



L15 - CANTONEIRA P/ SAPATA 70X40X40
4x



M9 - CANTONEIRA L 2 FUROS ZAMAK
1x



M11 - PREGO 10x10
50x



