

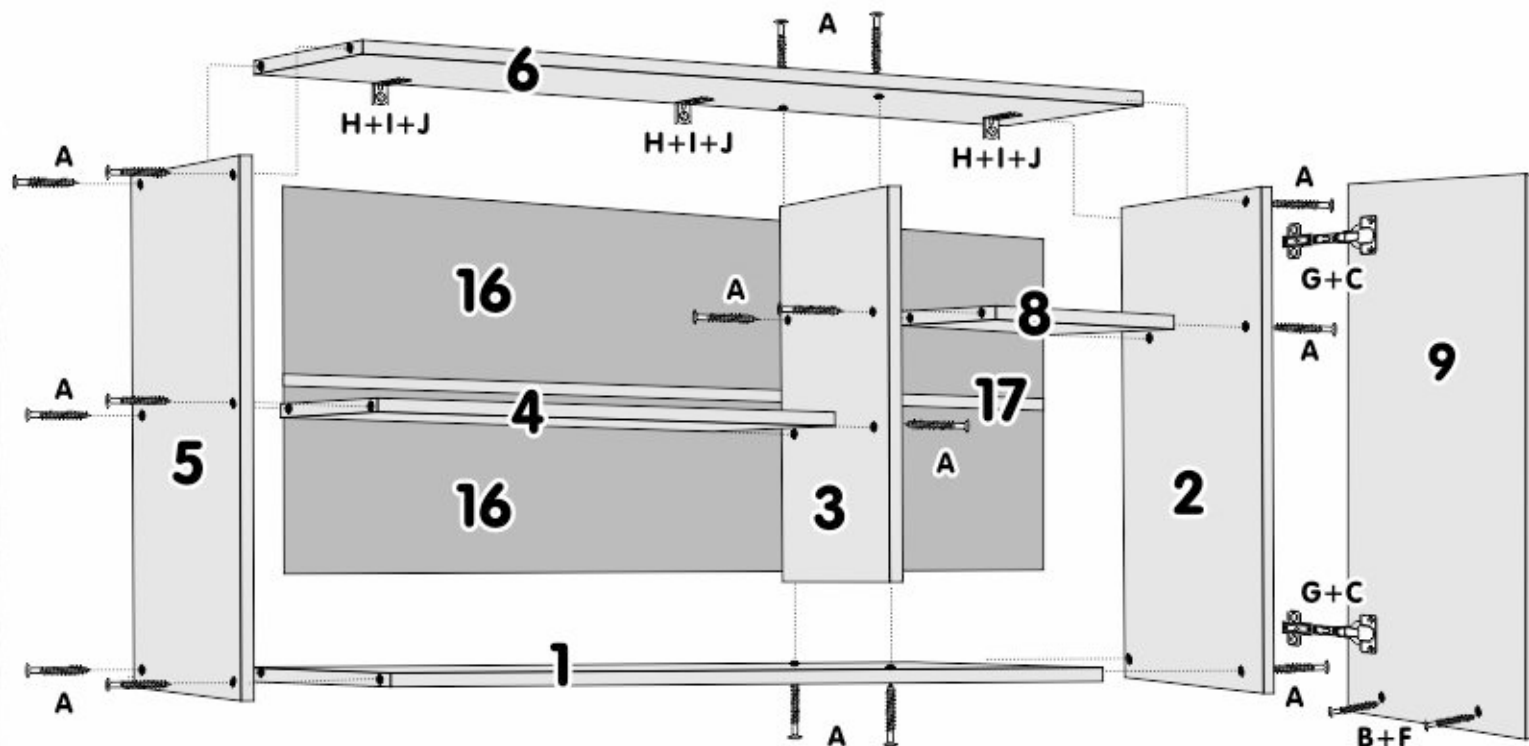

Armário Aéreo ETIOS - Ref.: 1285

COMPONENTES

1 - BASE	10 - COSTAS
2 - PÉ	11 - PERFIL H
3 - LATERAL ESQUERDA	12 - FRENTE GAVETA
4 - DIVISÃO PRATELEIRA	13 - LATERAL GAVETA
5 - PRATELEIRA	14 - TRASEIRO GAVETA
6 - LATERAL DIREITA	15 - FUNDO GAVETA
7 - TRAVESSA MAIOR	16 - COSTAS
8 - TAMPO	17 - PERFIL H
9 - PORTA	



ATENÇÃO:
AS COSTAS É FIXADA COM PREGOS 10x10.

SR. MONTADOR, CASO HAJA ASSISTÊNCIA, ANOTAR NÚMERO DA PEÇA, NOME E COR, PASSE PARA A PESSOA RESPONSÁVEL, PARA QUE POSSAMOS ATENDÊ-LO O MAIS RÁPIDO POSSÍVEL.



A - Paraf. 5x50 Sextavado



C - Paraf. 3,5x14



F - Puxador

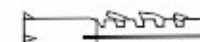

H - Bucha

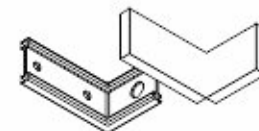

I - Cantoneira Parede

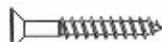

B - Paraf. 4x25



D - Prego 10x10



G - Dobradiça de Pressão

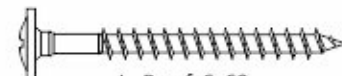

J - Paraf. 6x60

KAIKI

MÓVEIS

KAIKI MÓVEIS INDÚSTRIA E COMÉRCIO LTDA.

Av. Raul Alves Ferreira, 311 - Centro - Fone/Fax (32) 3577-1198
 CEP 36510-000 - Rodeiro - MG
 vendas@kaikimoveis.com.br



Balcão VIRTUS Ref.: 1284

Sr. Montador, caso haja assistência, anotar número da peça, nome e cor, passe para a pessoa responsável, para que possamos atendê-lo o mais rápido possível.

COMPONENTES

1 - BASE	10 - COSTAS
2 - PÉ	11 - PERFIL H
3 - LATERAL ESQUERDA	12 - FRENTE GAVETA
4 - DIVISÃO PRATELEIRA	13 - LATERAL GAVETA
5 - PRATELEIRA	14 - TRASEIRO GAVETA
6 - LATERAL DIREITA	15 - FUNDO GAVETA
7 - TRAVESSA MAIOR	16 - SUPORTE TRAV. MAIOR
8 - TAMPO	17 - COSTAS VERTICAL
9 - PORTA	18 - TRAVESSA MENOR

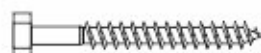

A - Paraf. 5x50 Sextavado

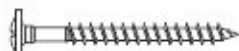

B - Paraf. 4x40 Flangeado



C - Paraf. 5x40

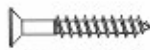

D - Paraf. 4x25



E - Paraf. 3,5x14



F - Prego 13x15

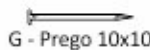

G - Prego 10x10

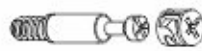

H - Minifix



I - Cavilha 6x30

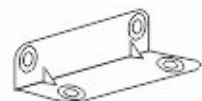

J - Cantoneira 4 Furos



L - Dobradiça de Pressão



M - Chave Allen



N - Corrediça Telescópica



O - Puxador



**PIA OPCIONAL
SÓ ENCAIXAR NO
LUGAR DO TAMPO**

VISTA TRASEIRA
PEÇA 7 MOSTRANDO
PEÇA 16
SUPORTE TRAV. MAIOR

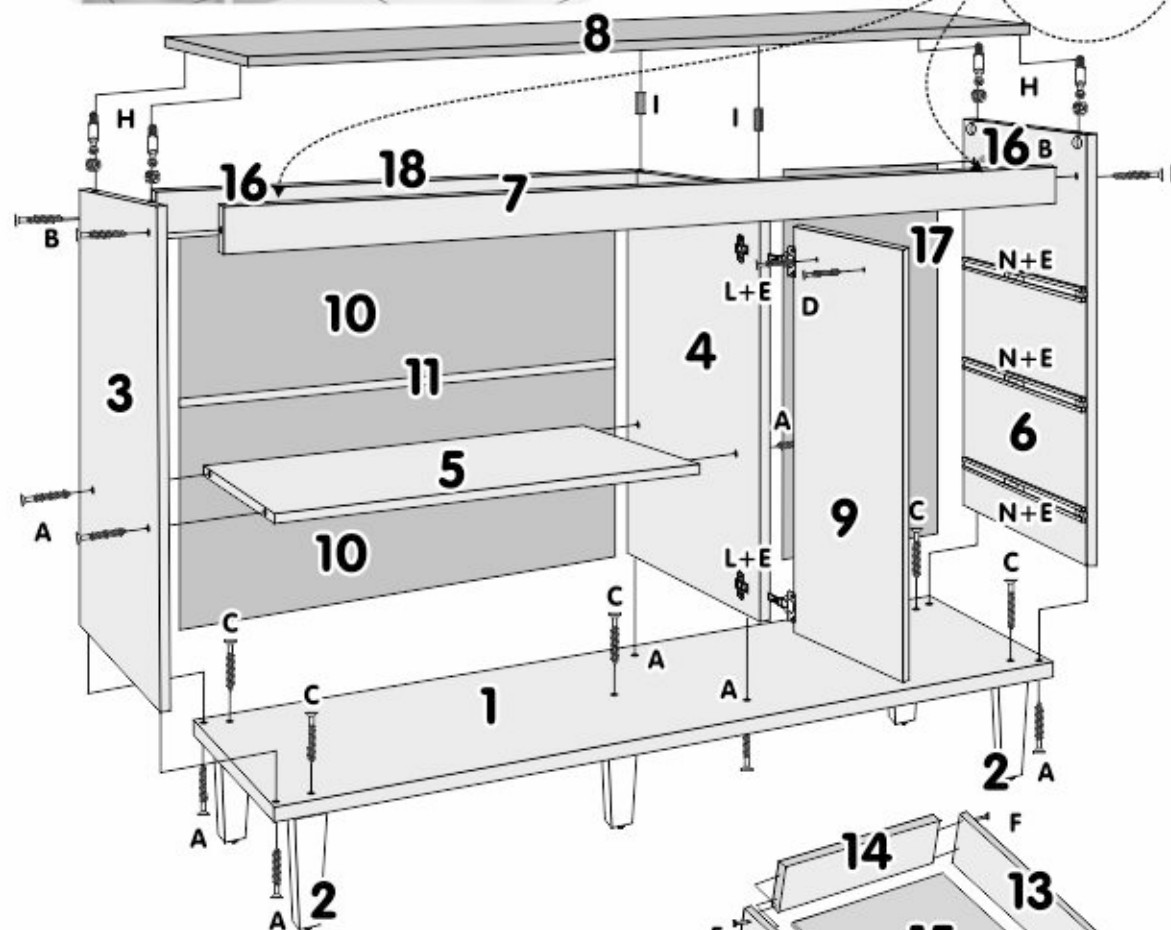
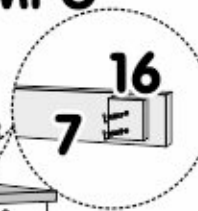

ATENÇÃO:
AS COSTAS E FUNDO DA GAVETA SÃO FIXADOS
COM PREGOS 10x10.

