

ASSEMBLY INSTRUCTIONS

Ref.: 200768 - ELB0083.01 | Review 01

INSTRUCTIONS DE MONTAGE | MANUAL DE ARMADO | ESQUEMA DE MONTAGEM

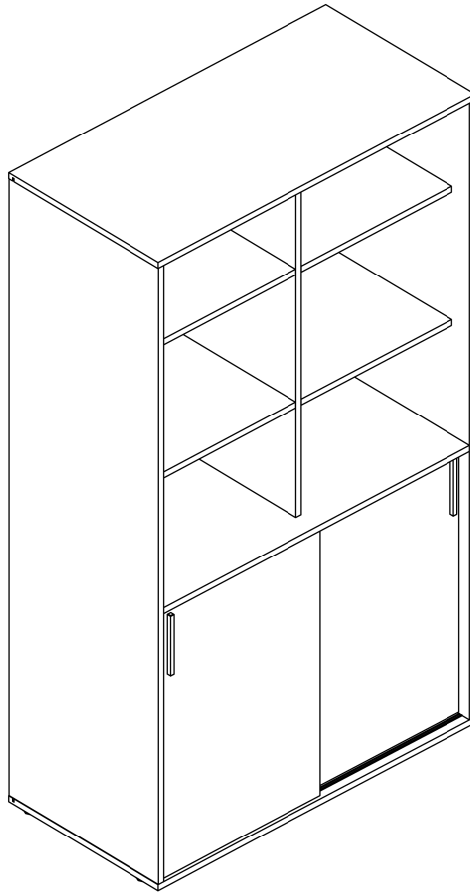

YOU WILL NEED

TU AURAS BESOIN DE | NECESITARÁ | VOCÊ VAI PRECISAR

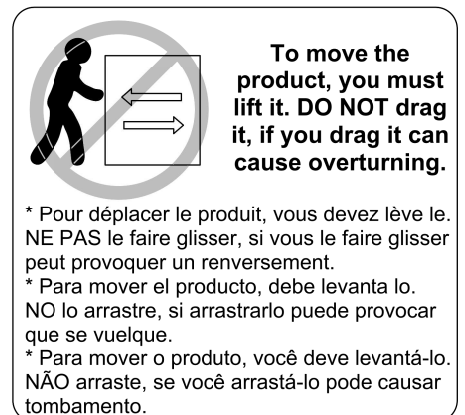
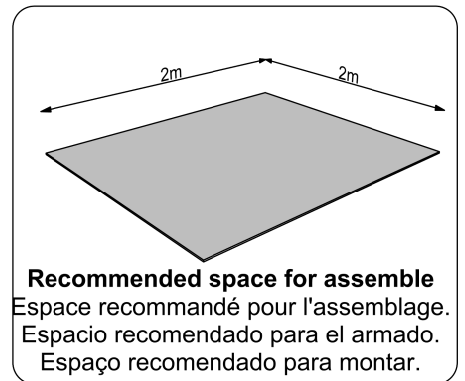
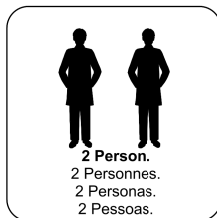
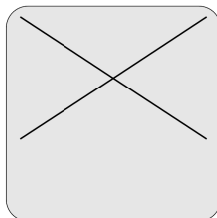
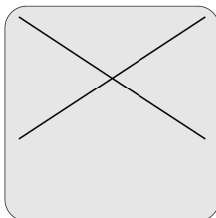
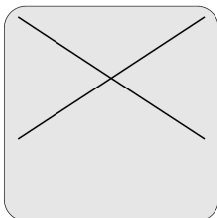
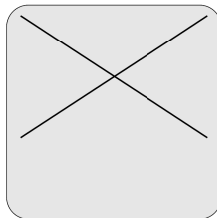
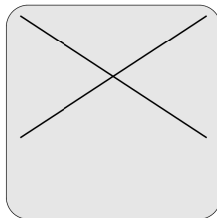
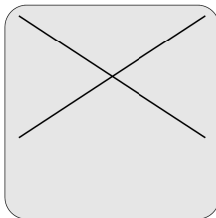
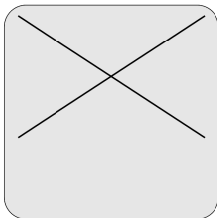
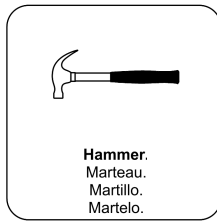
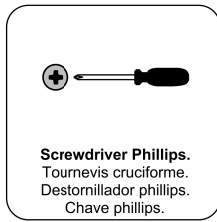
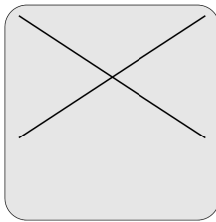
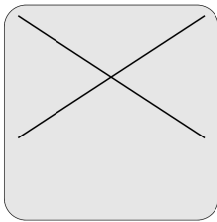

Tools not included

Outils non inclus | Herramientas no incluidas | Ferramentas não inclusas

ACCESSORIES IDENTIFICATION

IDENTIFICATION DES ACCESSOIRES | IDENTIFICACIÓN DE ACCESORIOS
IDENTIFICAÇÃO DOS ACESSÓRIOS

A		Qty./Qtd. 20
Wooden dowel / Chevilles en bois / Taquete / Cavilha		
AM		Qty./Qtd. 4
Wooden dowel / Chevilles en bois / Taquete / Cavilha		
AT		Qty./Qtd. 2
Minifix screw / Vis minifix / Tornillo minifix / Haste Minifix		
B		Qty./Qtd. 4
Structural screw / Vis à tête structurale / Tornillo estructural / Parafuso Estrutural		
BB		Qty./Qtd. 16
Shelf support / Support d'étagère / Soporte de estantería / Suporte prateleira		
BV		Qty./Qtd. 4
Plastic foot / Pied en Plastique / Pie plástico / Sapata Plástica		
D		Qty./Qtd. 4
Flanged head screw / Vis à tête bride / Tornillo de cabeza flangeada / Parafuso Flangeado		
G		Qty./Qtd. 4
Simple minifix screw / Vis minifix simple / Tornillo minifix simple / Haste Minifix Simples		
H		Qty./Qtd. 14
Drum lock / Verrouillage du tambour / Tambor minifix / Tambor de Minifix		
J		Qty./Qtd. 00
Nail / Ongle / Clavo / Prego		
N		Qty./Qtd. 20
Pan head screw / Vis à tête bombée / Tornillo de pan / Parafuso Panela		
Z		Qty./Qtd. 14
Metal claw / Pince de métal / Garra metal / Garra de Metal		

PARTS IDENTIFICATION

IDENTIFICATION DES PIÈCES | IDENTIFICACIÓN DE PIEZAS | IDENTIFICAÇÃO DAS PEÇAS

01	Top Plan de Travail Tapa Tampo	Qty./Qtd. 01
02	Side Shelf Étagère Latérale Repisa Lateral Prateleira Lateral	Qty./Qtd. 04
03	Intermediate Base Base Intermédiaire Base Intermedia Base Intermediária	Qty./Qtd. 01
04	Shelf Étagère Repisa Prateleira	Qty./Qtd. 01
05	Base Base Base Base	Qty./Qtd. 01
06	Left Side Côté Gauche Lateral Izquierdo Lateral Esquerda	Qty./Qtd. 01
07	Division Division División Divisória	Qty./Qtd. 01
08	Bottom Division Division Inférieur División Inferior Divisória Inferior	Qty./Qtd. 02
09	Right Side Côté Droite Lateral Derecho Lateral Direita	Qty./Qtd. 01
10	Left Door Porte Gauche Puerta Izquierdo Porta Esquerda	Qty./Qtd. 01
11	Right Door Porte Droite Porta Derecho Porta Direita	Qty./Qtd. 01
12	Backboard Panneau Fondo Trasero Costa	Qty./Qtd. 02

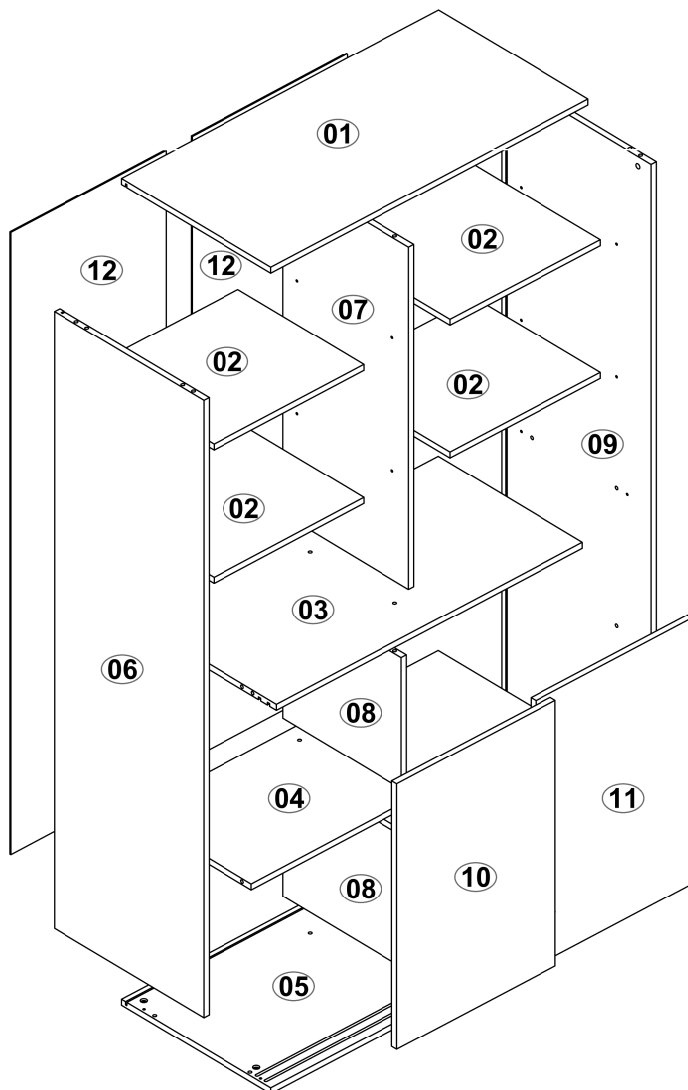

PRE-ASSEMBLY - PRÉ-ASSEMBLAGE - PRE-ARMADO
PRÉ-MONTAGEM

01 -

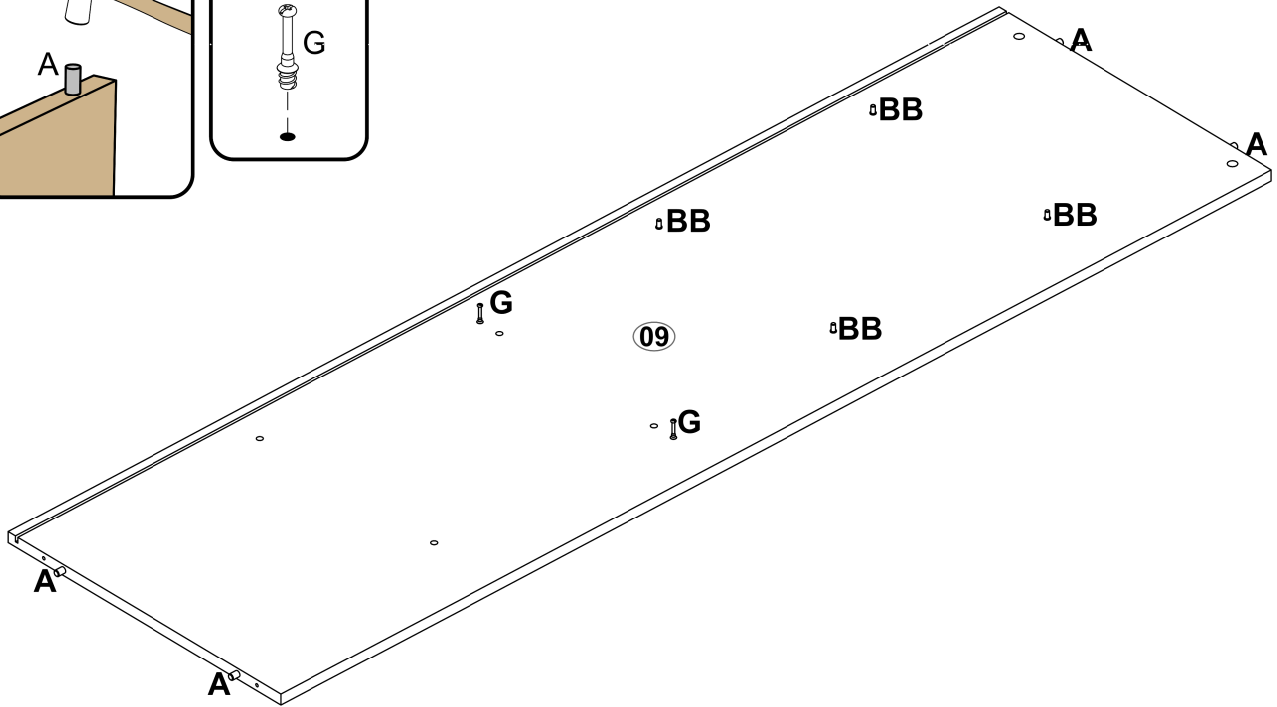
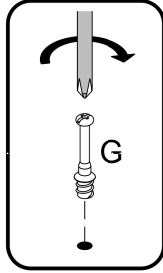
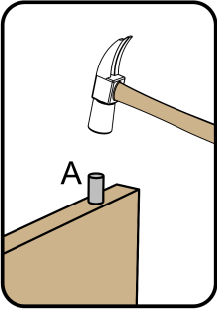

02 -

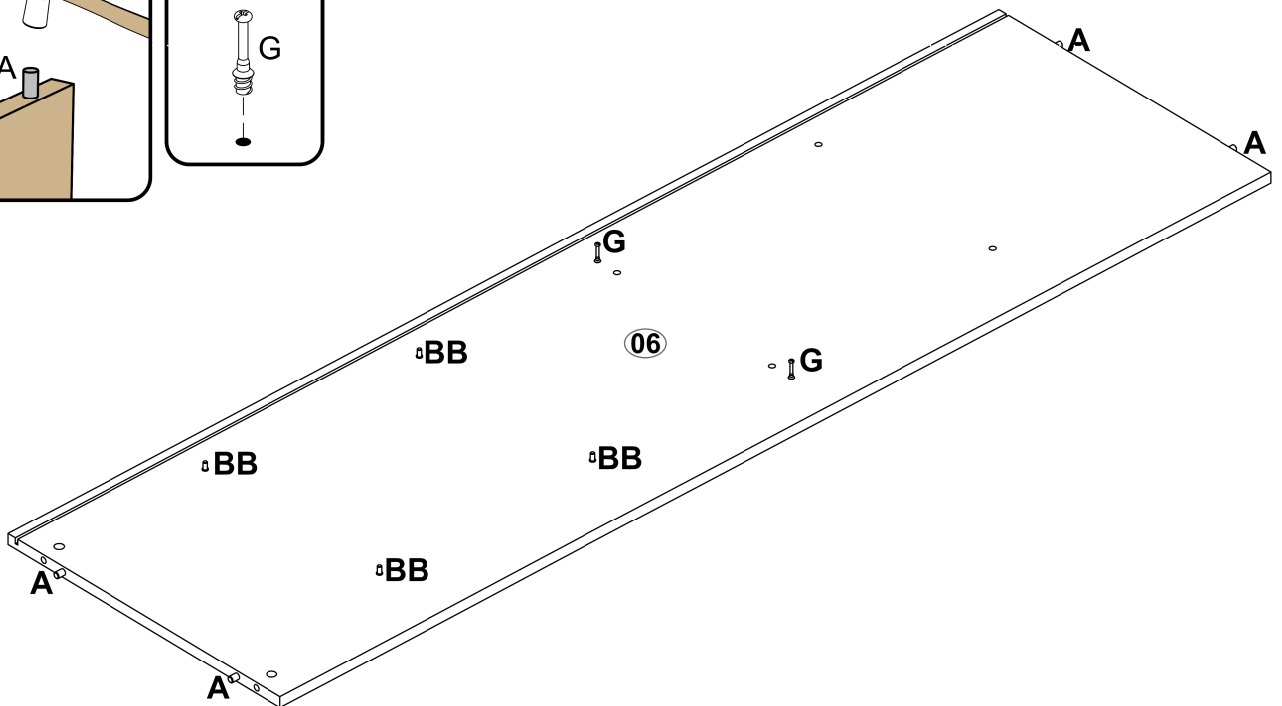
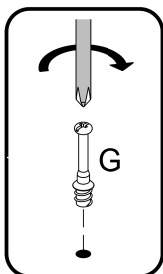
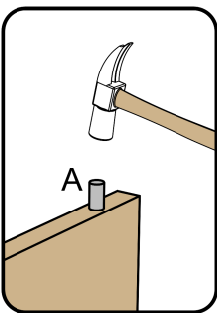

03 -

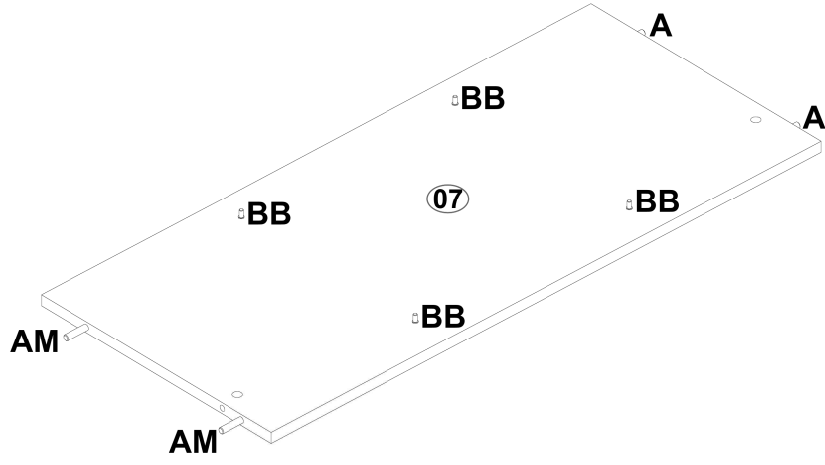
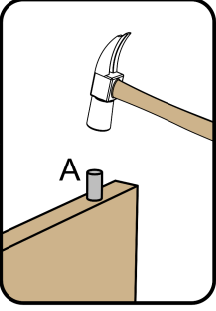

04 -

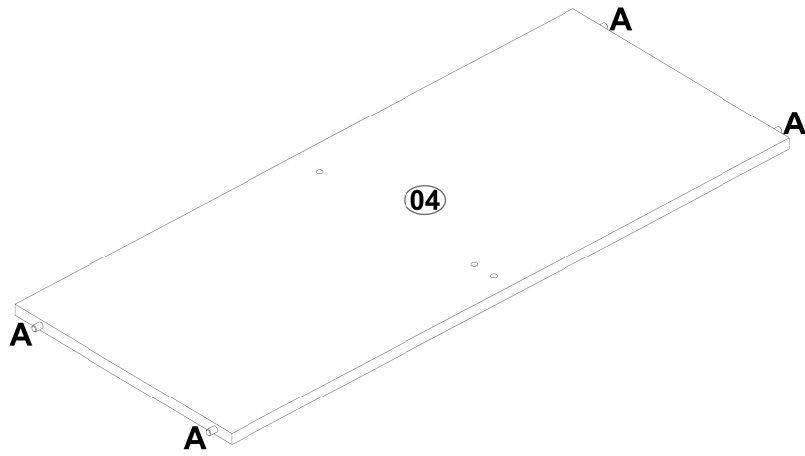
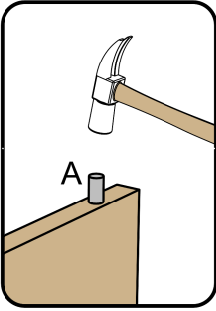

05 -

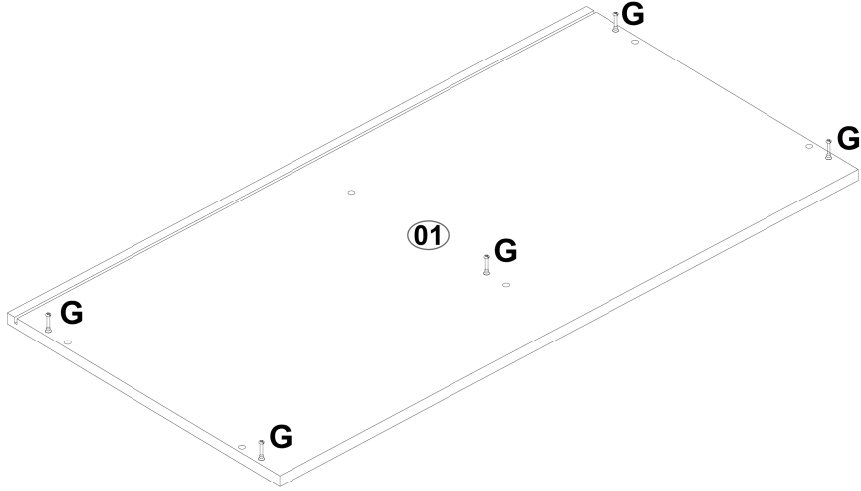
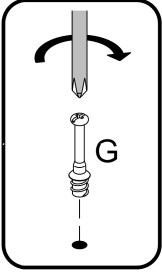

06 -

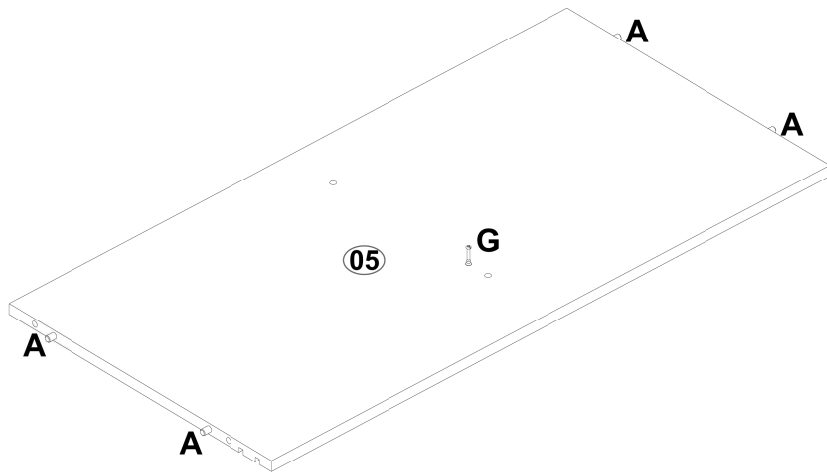
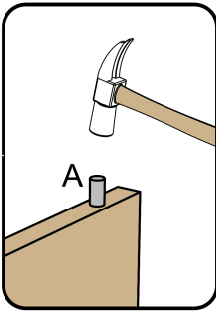

07 -

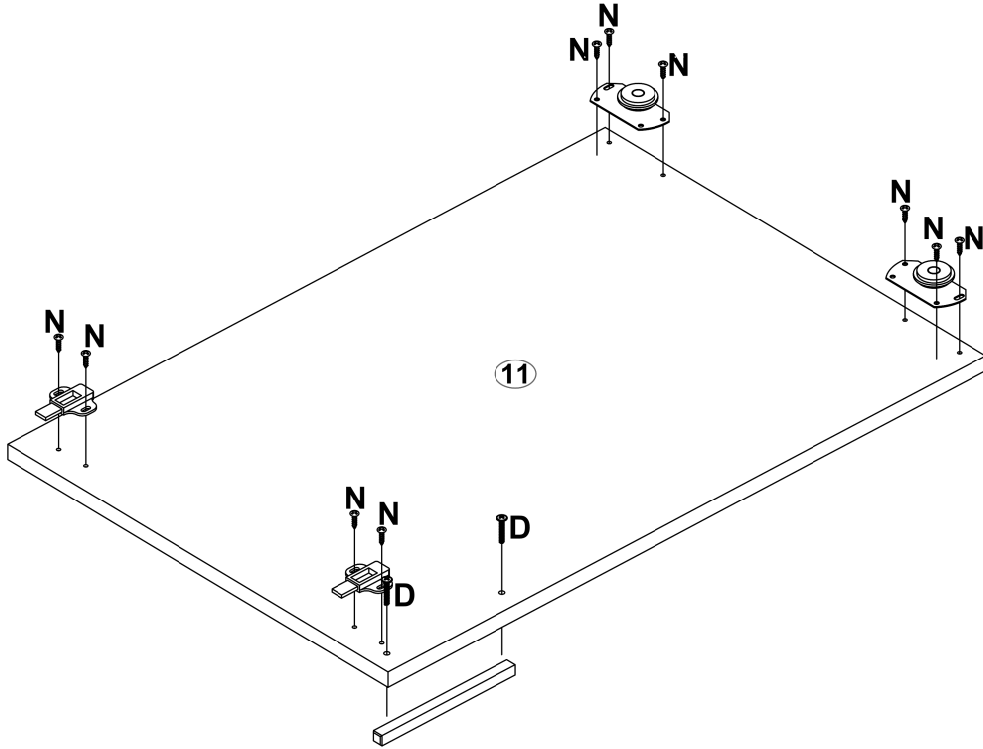

08 -

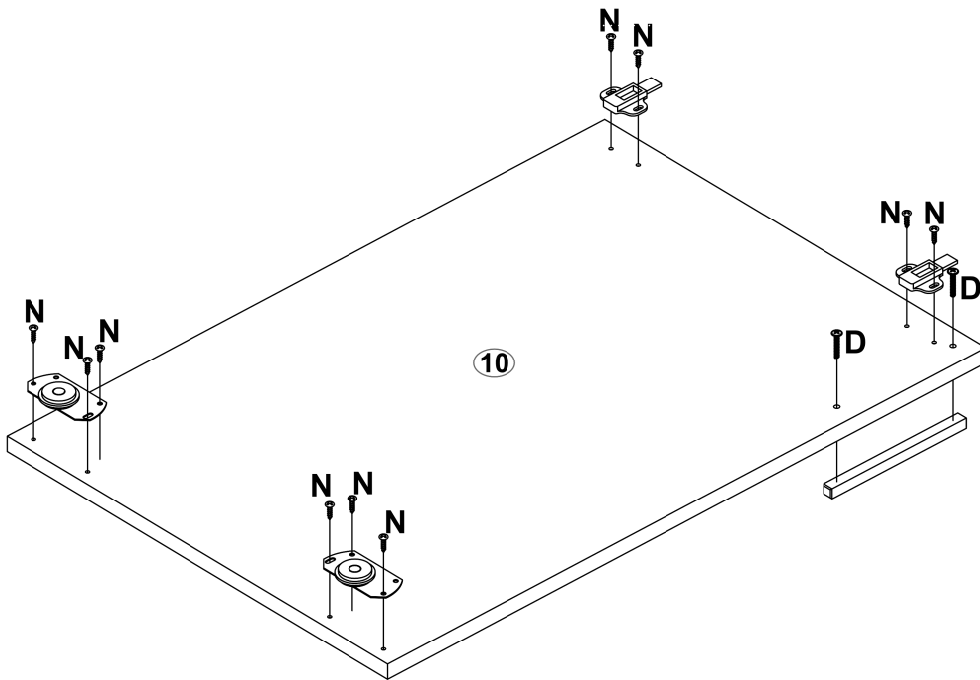

09 -

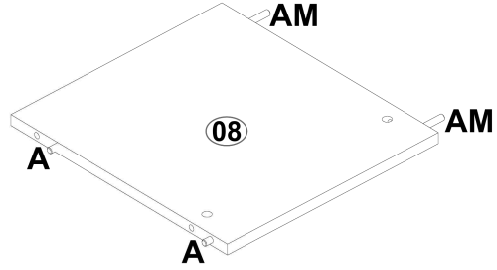
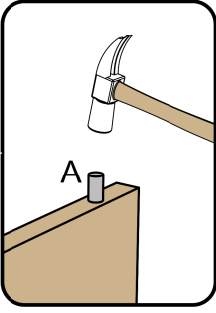

ASSEMBLY - MONTAGE - ARMADO - MONTAGEM

10 -

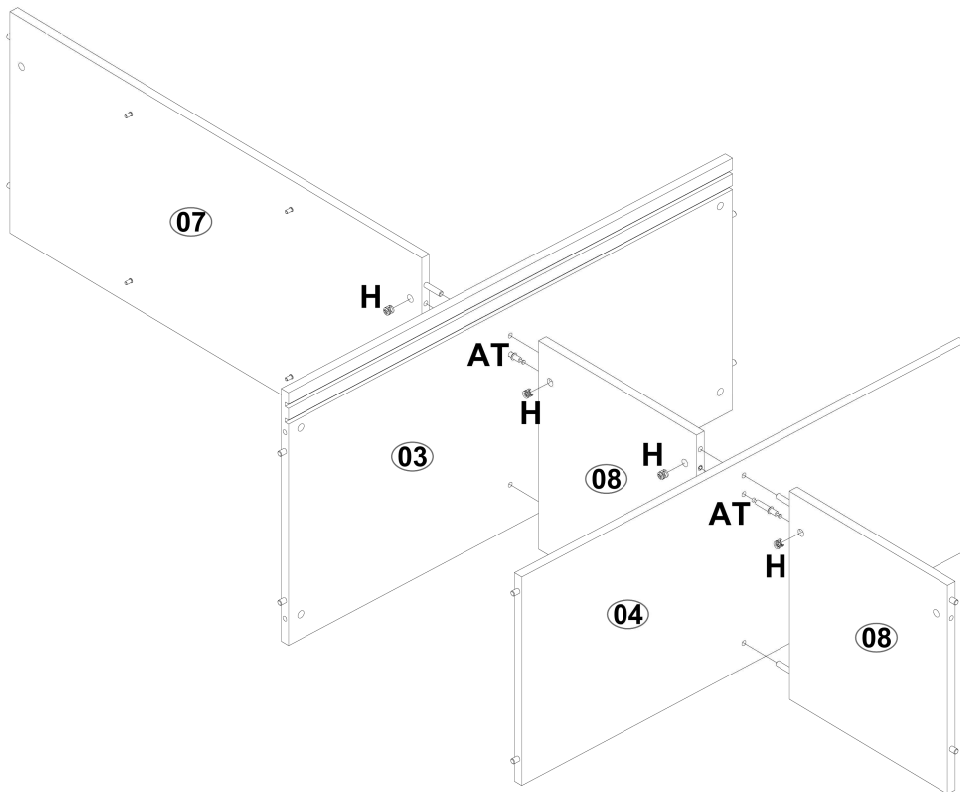

11 -

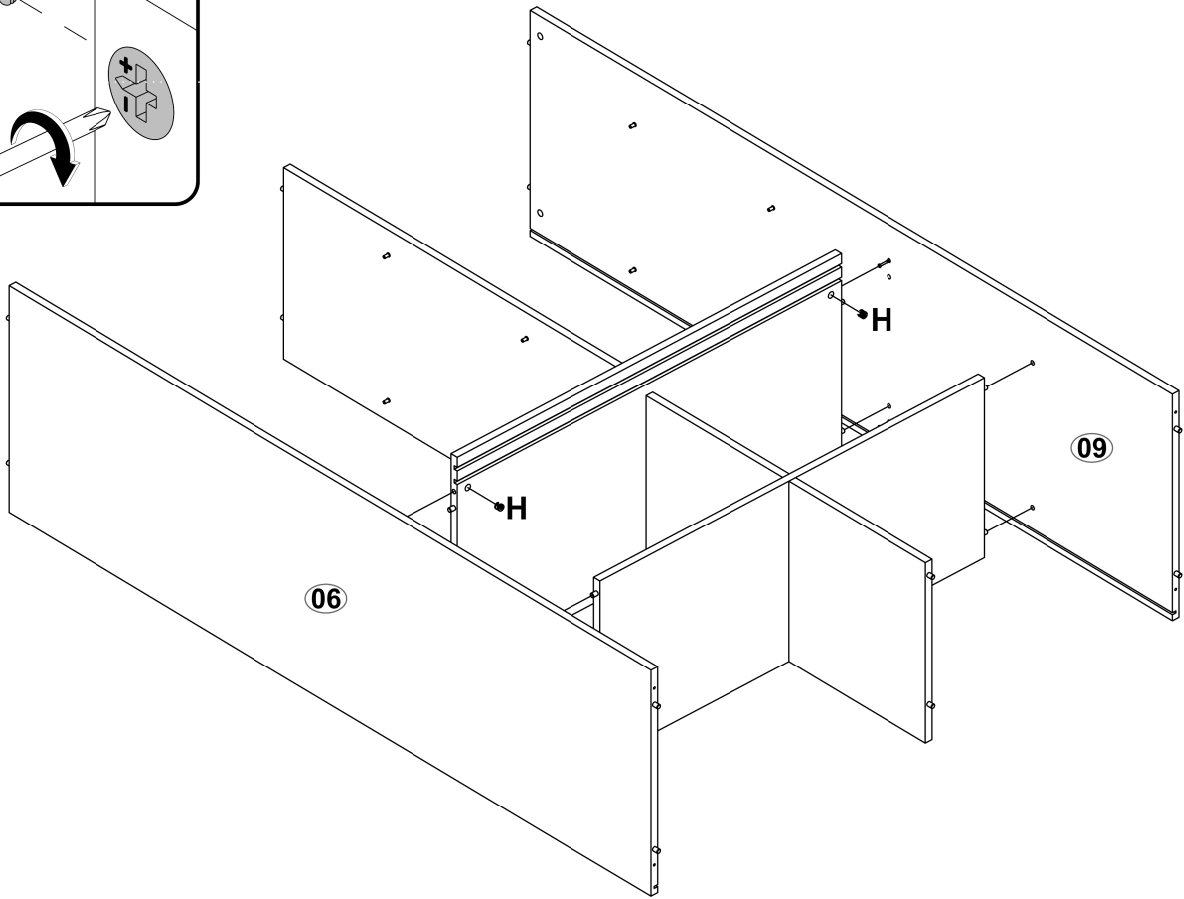
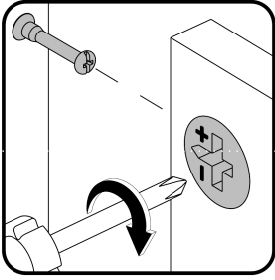

12 -

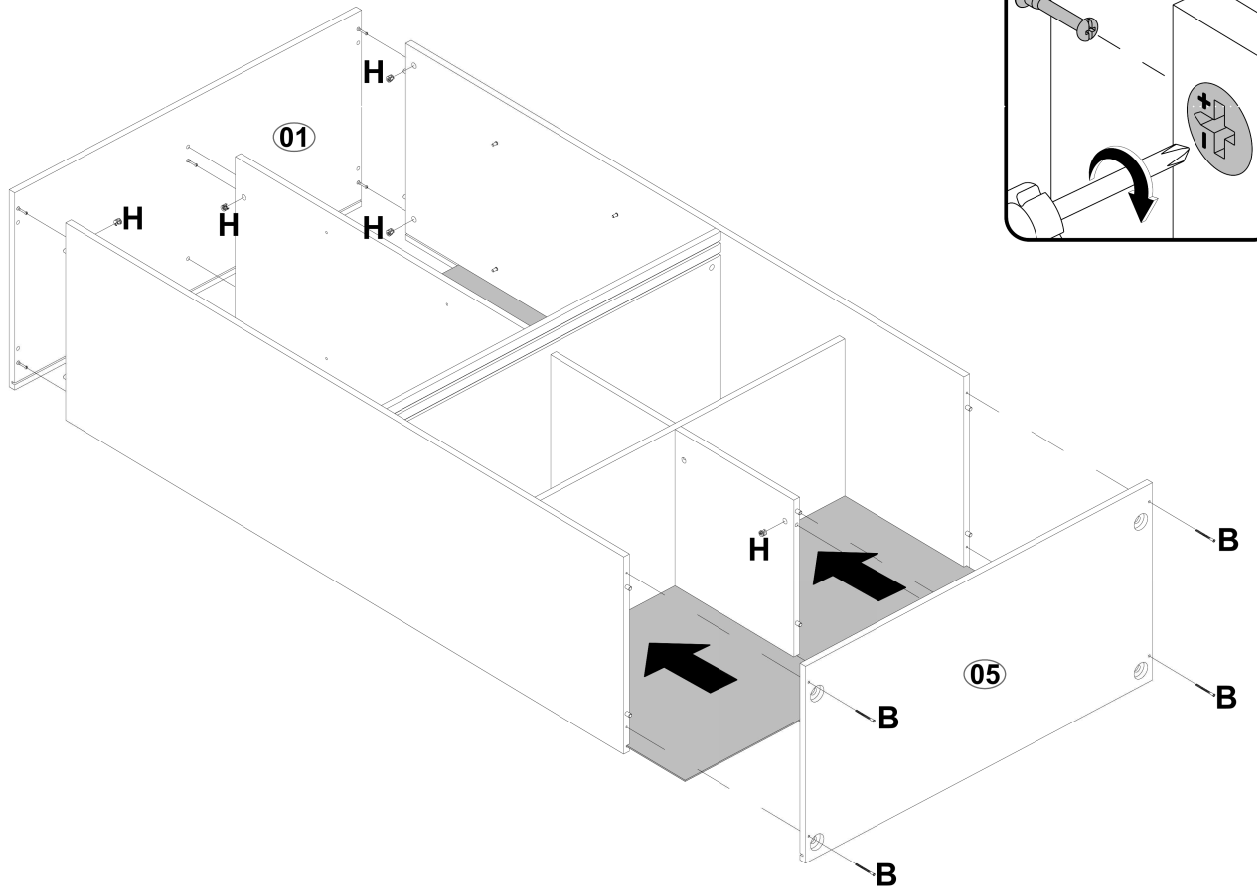
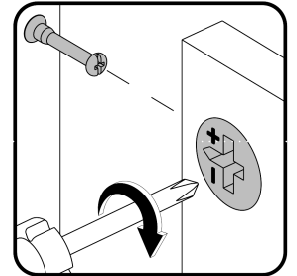

13 -

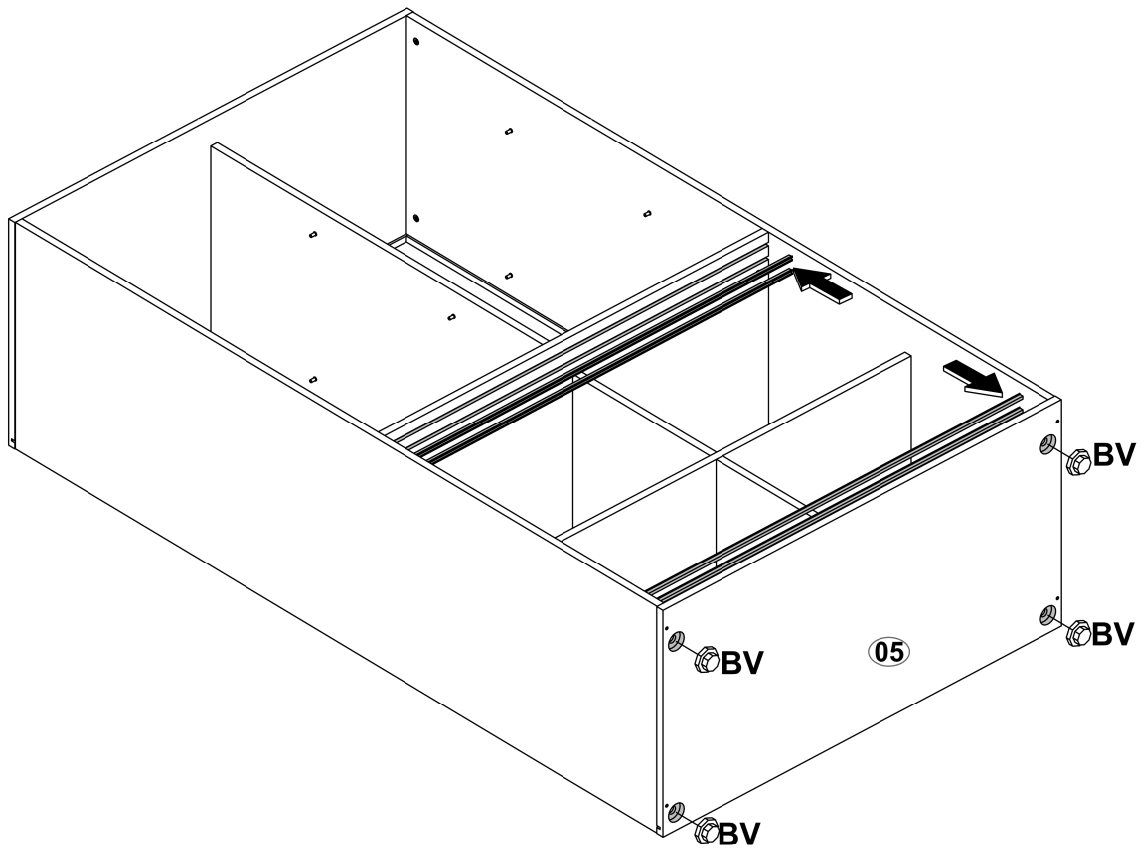

14 -

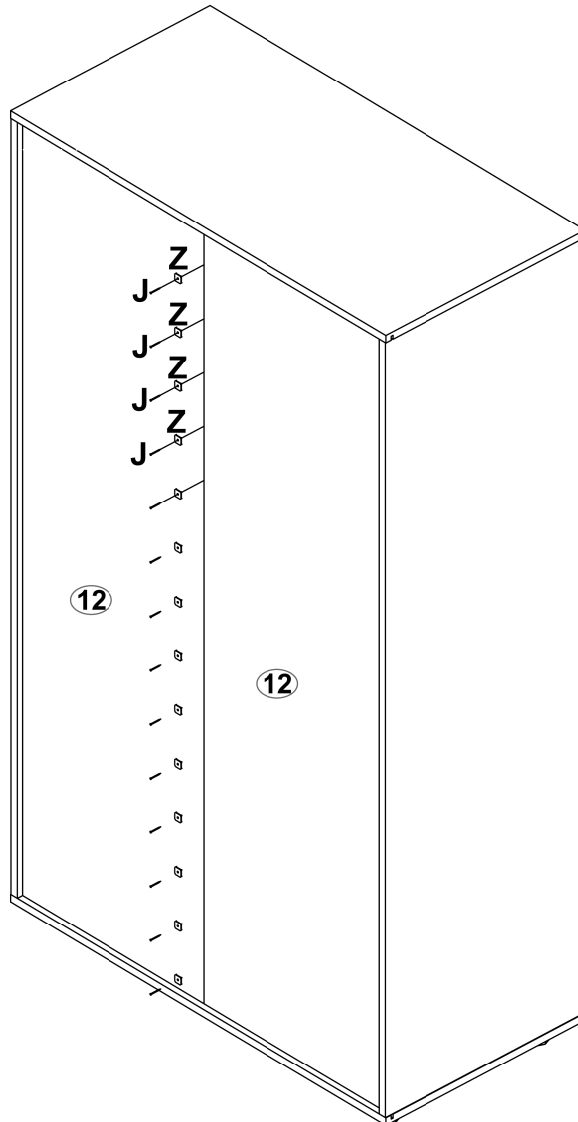

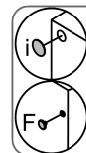
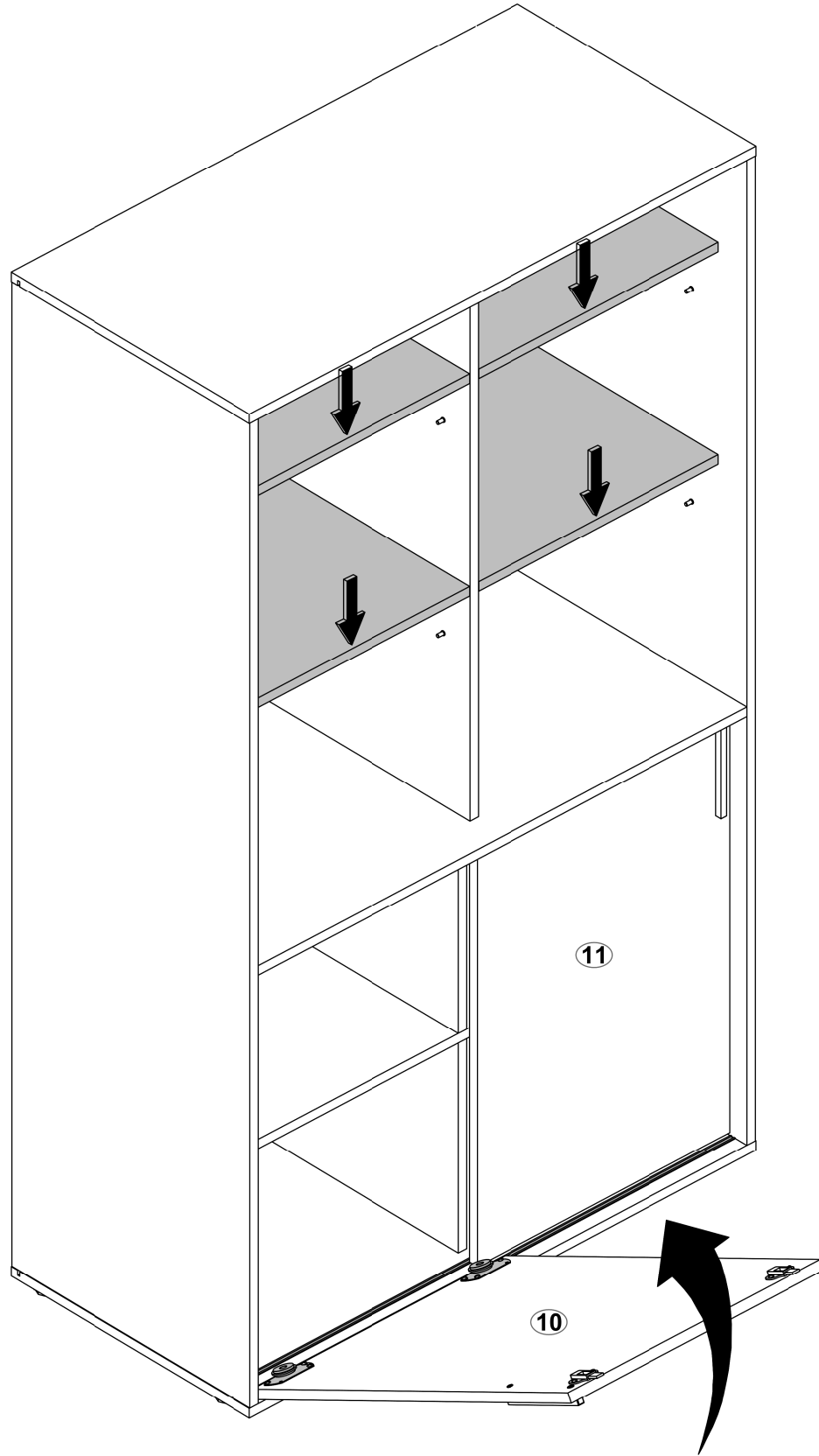

***Note:** Use the stickers and caps to finish.
***Remarque:** Utiliser les autocollants et les capuchons pour terminer la finition.
***Nota:** Utilice los adhesivos y tapas para finalizar el acabado.
***Nota:** Utilize os adesivos e tampas para finalizar o acabamento.