

Cozinha Modulada Agata 4 Peças

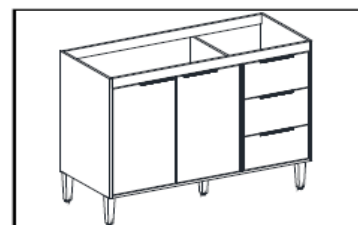

B **Balcão De Pia Ágata**
REF.: 501
MANUAL DE MONTAGEM

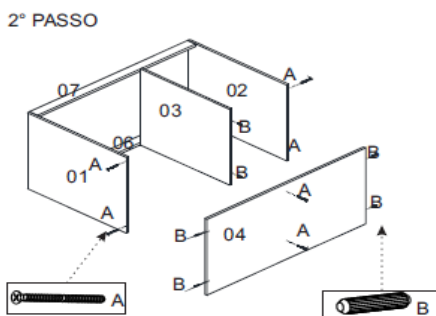
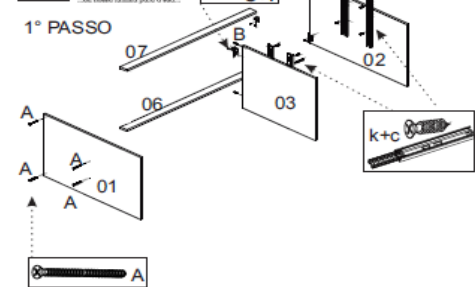

FERRAGENS

A	18	Parafuso 3,5 x 40	
B	20	Cavilha 6 X 30	
C	65	Parafuso 3,5 x 14	
D	06	Dobradiça Super Alta	
E	05	Puxador	
F	05	Sapata	
G	70	Prego 10 x 13	
I	04	Cantoneira	
J	01	Perfil H	
K	02	Corrediça	
L	05	Parafuso 4 x 50	
M	04	Suporte Prateleira	
N	03	Batente Plástico Porta	

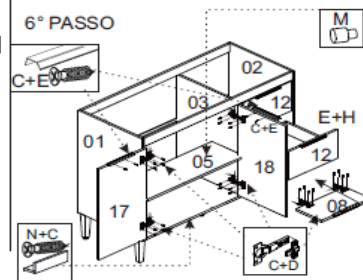
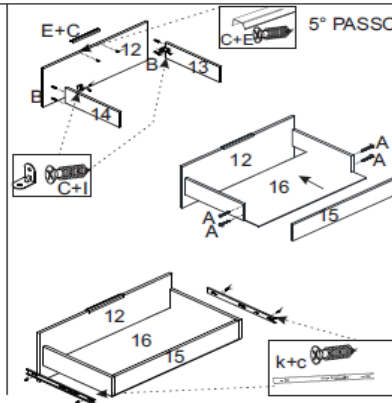
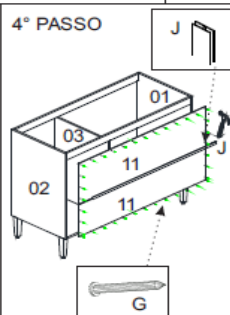
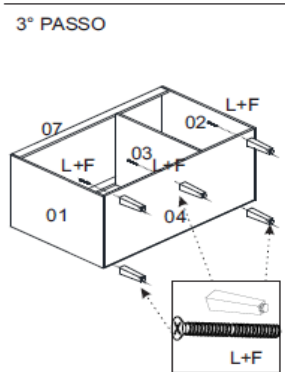



AÉREO 4PTS ÁGATA
REF.: 505
MANUAL DE MONTAGEM

deibe móveis

1º PASSO

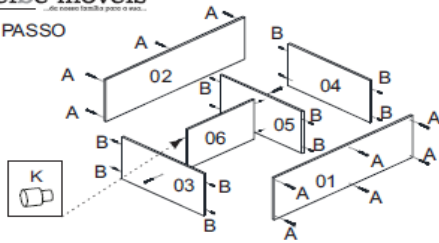

2º PASSO

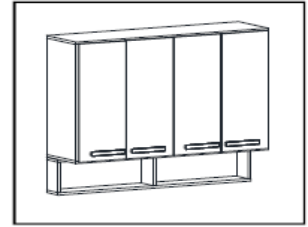
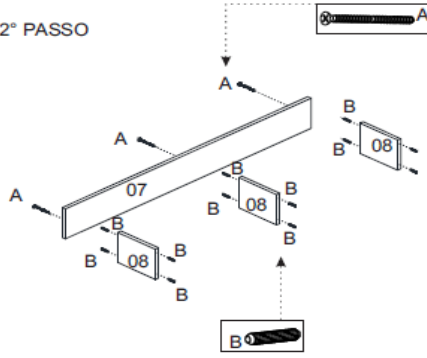

FERRAGENS

A	20	Parafuso 3,5 x 40	
B	28	Cavilha 6 X 30	
C	40	Parafuso 3,5 x 12	
D	03	Suporte Aéreo	
E	08	Dobradiça Com Calço Curva	
F	04	Puxador	
G	03	Bucha 8mm	
H	30	Prego 10 x 13	
I	06	Parafuso 3,5 x 25	
J	03	Parafuso 4,5 x 50	
K	04	Suporte Prateleira	

3º PASSO

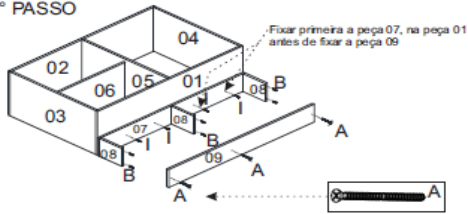

4º PASSO

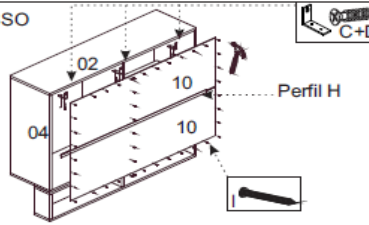

5º PASSO

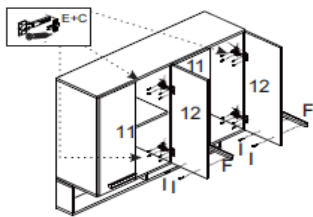

6º PASSO

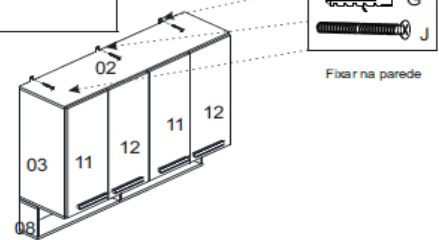

PANELEIRO ÁGATA
REF.: 205
MANUAL DE MONTAGEM

deibe móveis

MANUAL DE MONTAGEM

1º PASSO

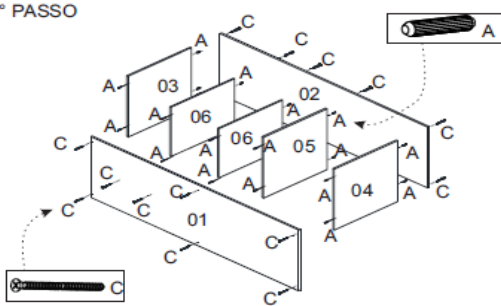

2º PASSO

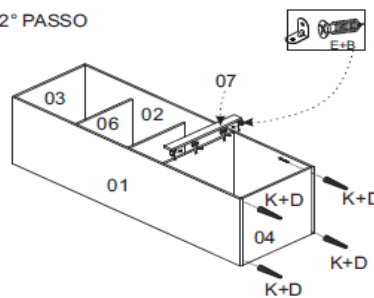

FERRAGENS

A	22	Cavilha 6 X 30	
B	50	Parafuso 3,5 x 14	
C	18	Parafuso 3,5 x 40	
D	04	Parafuso 4 x 50	
E	04	Cantoneira	
F	60	Prego 10 x 13	
G	08	Dobradiça 26mm alta	
H	04	Batente Plástico	
I	01	Perfil H	
J	04	Puxador	
K	04	Sapata	

3º PASSO

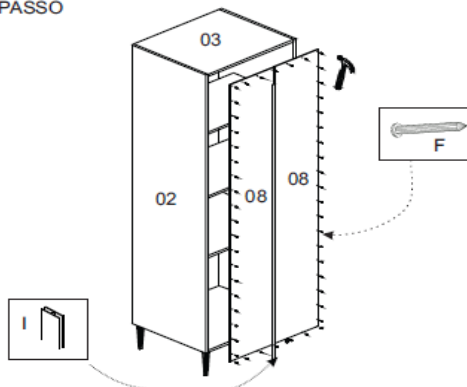

4º PASSO

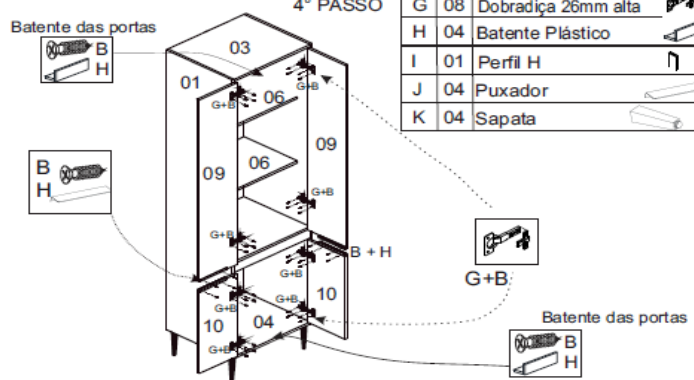



1° PASSO

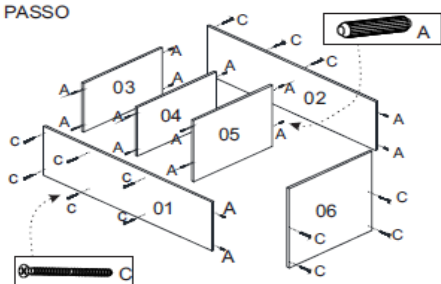

2° PASSO

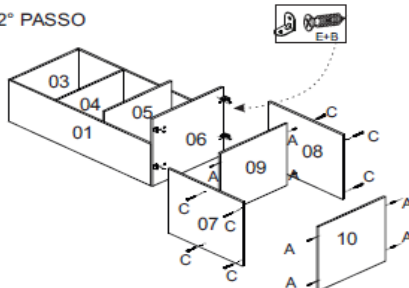

3° PASSO

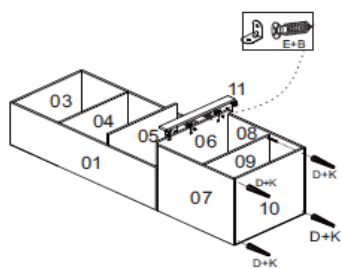



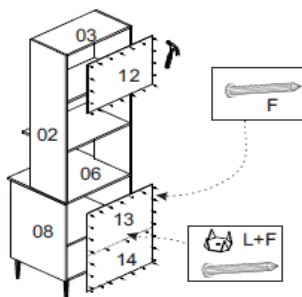



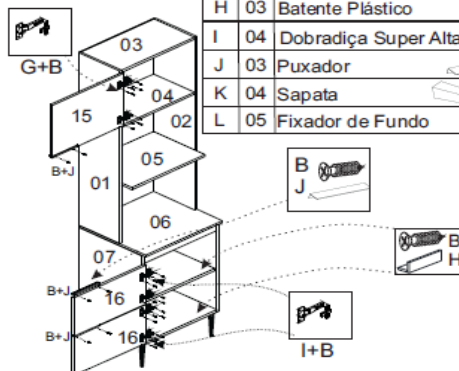

4° PASSO



5° PASSO



FERRAGENS

A	30	Cavilha 6 X 30	
B	60	Parafuso 3,5 x 14	
C	24	Parafuso 3,5 x 40	
D	04	Parafuso 4 x 50	
E	08	Cantoneira	
F	40	Prego 10 x 13	
G	02	Dobradiça 26mm alta	
H	03	Batente Plástico	
I	04	Dobradiça Super Alta	
J	03	Puxador	
K	04	Sapata	
L	05	Fixador de Fundo	