

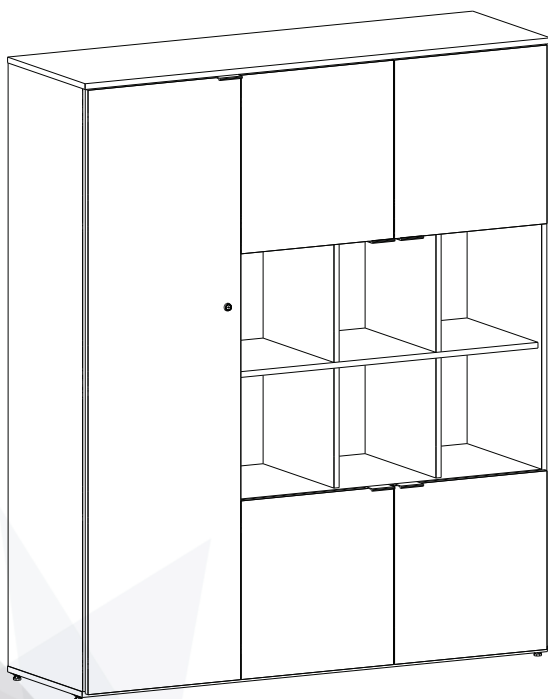

Manual de montagem

Manual del producto/ User's guide



Armário Kuadra Alto com Nicho 135

KUAN135



A Compace agradece pela confiança em
nossos produtos!
Tenha uma boa montagem...

La Compace le agradece su confianza en
¡nuestros productos!
Buen montaje ...

The Compace thanks you for your confidence in
our products!
Have a good montage...



+ de 15 anos
de mercado



+ de 500
despachos por dia



+ de 400
pedidos por dia

Como devolver ou trocar seu produto se chegou avariado:

1

Tenha em mãos: as fotos das peças com defeito; nome; código e quantidade de peças.

Have at hand: the photos of the defective parts; Name; code and quantity of parts.

Tenga a mano: las fotos de las piezas defectuosas; Nombre; código y cantidad de piezas.

2

Acesse o chat da plataforma em que realizou sua devida compra.

Access the chat of the platform where you performed your due purchase.

Accede al chat de la plataforma donde realizaste tu debido compra.

3

Faça o envio e informe se deseja a devolução ou reposição do item danificado.

Send it and let us know if you want a return or replacement of the damaged item.

Envíalo y avísanos si quieres una devolución o Reemplazo del artículo dañado.

4

Pronto! Agora é só aguardar o contato da nossa equipe de suporte, que irá lhe passar os próximos passos.

Ready! Now just wait for our contact. support team, who will give you the next steps.

¡Listo! Ahora solo espera nuestro contacto. equipo de soporte, que le dará el siguiente pasos.

Prepare-se para a montagem

- ✓ Antes de iniciar a montagem, leia atentamente todas as instruções deste manual.

Antes de comenzar el montaje, lea atentamente todas las instrucciones de este manual.
Before starting assembly, carefully read all instructions in this manual.

- ✓ Monte seu produto em uma superfície limpa e plana. Para não danificar, aconselhamos utilizar a embalagem ou um tapete para forrar o chão.

Monte su producto sobre una superficie limpia y plana. Para no dañar, le recomendamos que utilice el embalaje o una alfombrilla.

Mount your product on a clean, flat surface. In order not to damage your product, we advise you to use the packaging or a floor mat.

- ✓ Evite batidas e contato com objetos cortantes.

Evitar golpes y contacto con objetos afilados.
Avoid knocking and contact with sharp objects.

Você vai precisar:



2 PESSOAS



30 MINUTOS

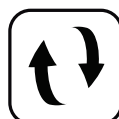

ROSQUEAR









MARTELO



PARAFUSADEIRA
CHAVE PHILIPS

ACESSÓRIOS

ITEM <small>Artículo/ Article</small>	DESCRIÇÃO <small>Descripción/ Description</small>	CÓDIGO <small>Translator/ Traductor</small>	QUANT. <small>Cantidad/ Amount</small>
A	 SAPATA NIVELADORA 1/4"	4691	6
B	 CHAPA RETA 15X45MM ROSCA 1/4	1060	6
C	 CAVILHA MADEIRA 8X30	7071	52
D	 DOBRADIÇA 35MM ALTA	1016	11
E	 PARAFUSO CAB. CHATA 3.5X14	1215	70
F	 BATENTE P/ FECHADURA 30X15MM	15394	1
G	 PARAFUSO CAB. CHATA 3.5X40	1222	10
H	 PINO MINIFIX	7067	26
I	 TAMBOR MINIFIX	7068	26
J	 PREGO COM CABEÇA 10X10	1143	65
K	 PUXADOR ALUMINIO 65X32X15MM	5334	5
L	 FECHADURA 22X17MM	1081	1
M	 CHAPA DE UNIÃO 13X13MM	22552	18
N	 TAMPA MINIFIX	-	26

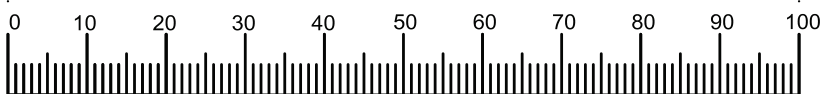

Utilize esta régua para medir as ferragens (medidas em mm)

PEÇAS

ITEM Artículo/ Article	DESCRIÇÃO Descripción/ Description	QUANT. Cantidad/ Amount	DIMENSÕES Dimensiones/ Dimensions	PESO (KG)
1	Divisória	1	1570mmx404mmx15mm	6,02 KG
2	Divisória Nicho	4	384mmx312mmx15mm	1,16 KG
3	Lateral Direita	1	1570mmx404mmx15mm	6,02 KG
4	Lateral Esquerda	1	1570mmx404mmx15mm	6,02 KG
5	Porta Esquerda	1	1573mmx443,5mmx15mm	6,73 KG
6	Porta Menor	4	465mmx442,5mmx15mm	2,02 KG
7	Prateleira	3	429mmx384mmx15mm	1,59 KG
8	Prateleira Central	1	873mmx384mmx15mm	3,27 KG
9	Prateleira Inferior	1	873mmx404mmx15mm	3,38 KG
10	Prateleira Superior	1	873mmx404mmx15mm	3,38 KG
11	Tampo inferior	1	1350mmx404mmx15mm	5,27 KG
12	Tampo Superior	1	1350mmx420mmx15mm	5,45 KG
13	Fundo menor	2	893,5mmx327mmx3mm	0,83 KG
14	Fundo nicho maior	1	475,5mmx893,5mmx3mm	1,19 KG
15	Fundo nicho menor	1	466,5mmx893,5mmx3mm	1,18 KG
16	Fundo maior	1	1596mmx449,5mmx3mm	2,06 KG

4X

1 Passo
Paso
Step

FERRAMENTAS
HERRAMIENTAS/ TOOLS

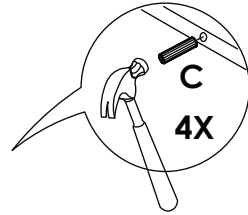
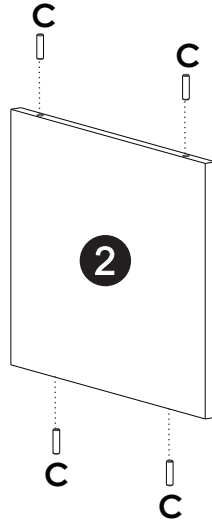
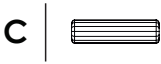

2 Passo
Paso
Step

FERRAMENTAS
HERRAMIENTAS/ TOOLS

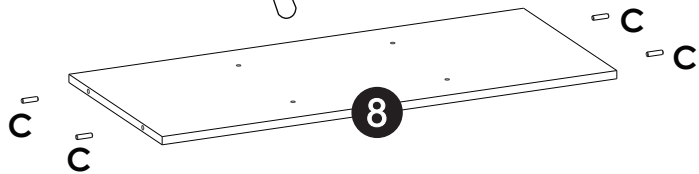
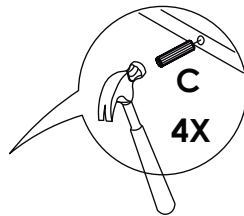
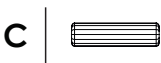

3 Passo Paso Step

FERRAMENTAS
HERRAMIENTAS/ TOOLS

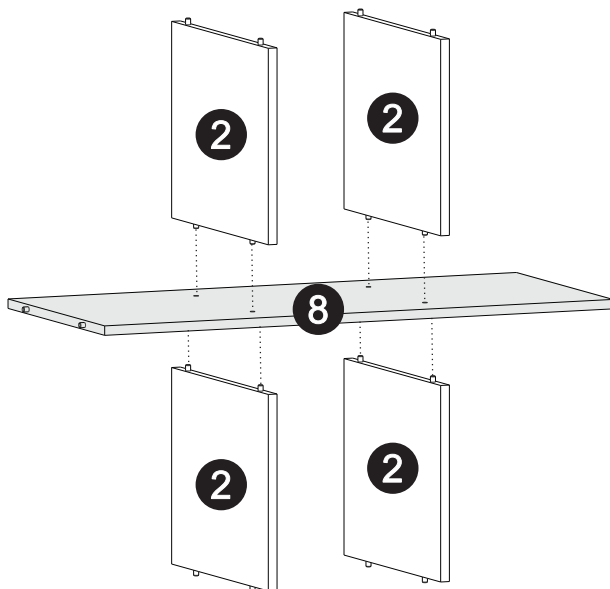

4 Passo Paso Step

FERRAMENTAS
HERRAMIENTAS/ TOOLS

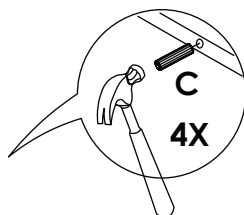

C



C

C

i

i

10

i

i

C

C

i



Depois de inserir as ferragens na peça,
vire ela novamente para o passo seguinte!

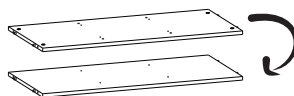

5

Passo
Paso
Step

FERRAMENTAS
HERRAMIENTAS/ TOOLS

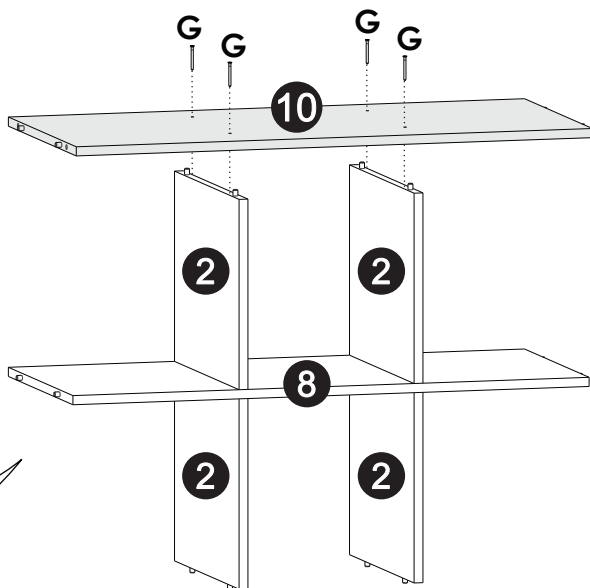
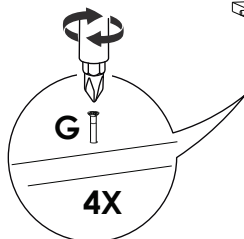

6

Passo
Paso
Step

FERRAMENTAS
HERRAMIENTAS/ TOOLS

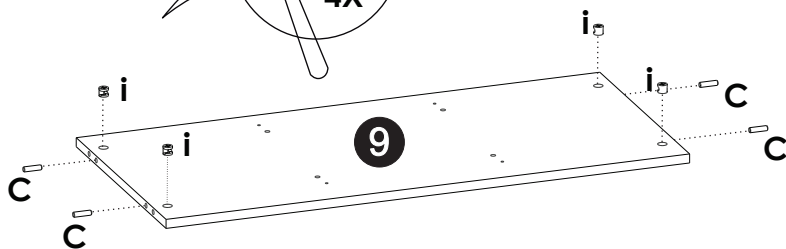
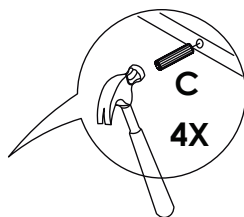
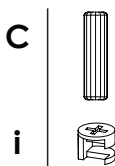

Depois de inserir as ferragens na peça,
vire ela novamente para o passo seguinte!



7

Passo
Paso
Step

FERRAMENTAS
HERRAMIENTAS/ TOOLS

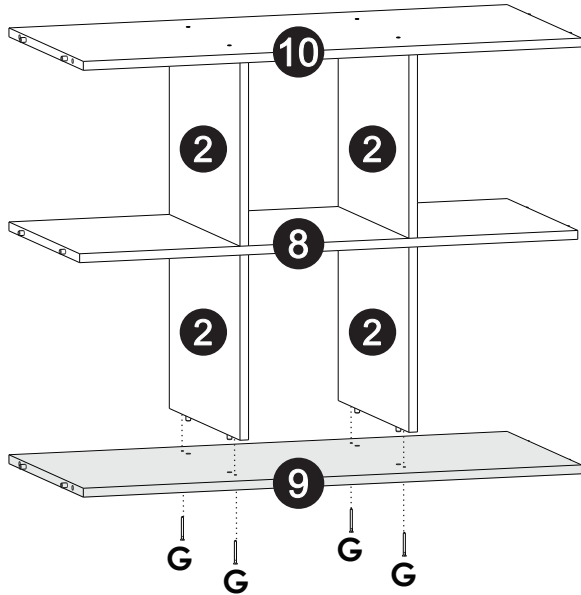
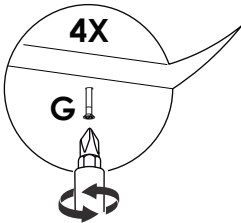

8

Passo
Paso
Step

FERRAMENTAS
HERRAMIENTAS/ TOOLS

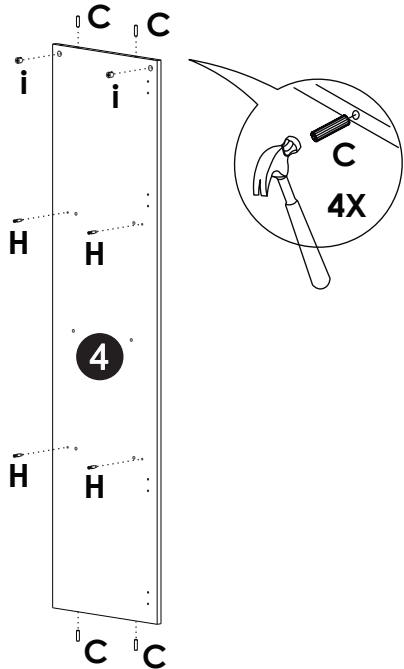
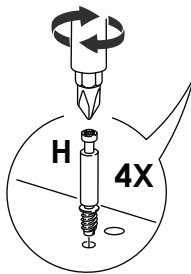
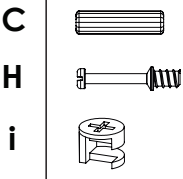

9

Passo
Paso
Step

FERRAMENTAS
HERRAMIENTAS/ TOOLS

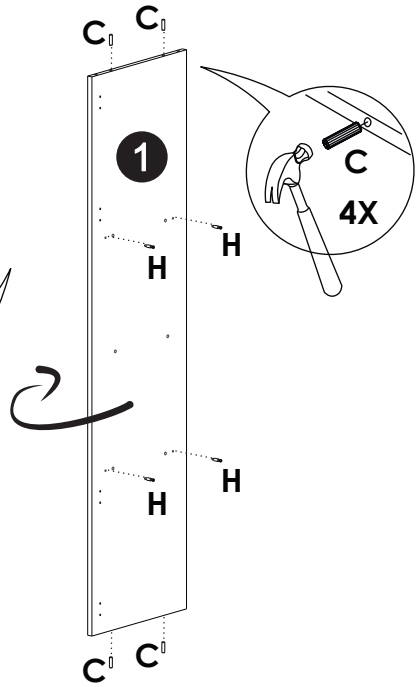
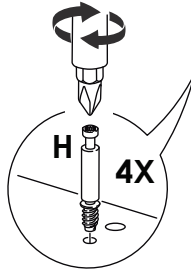
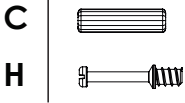

Gire a peça depois de pronta,
na outra face também tem ferragens!

10

Passo
Paso
Step

FERRAMENTAS
HERRAMIENTAS/ TOOLS

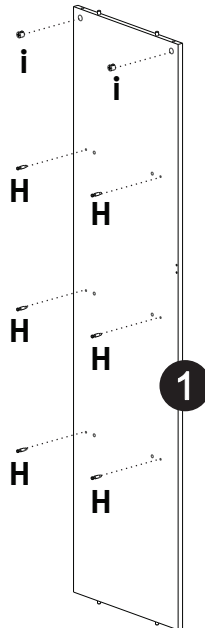
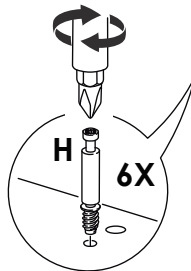
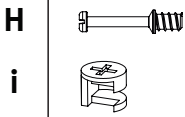

11

Passo
Paso
Step

FERRAMENTAS
HERRAMIENTAS/ TOOLS

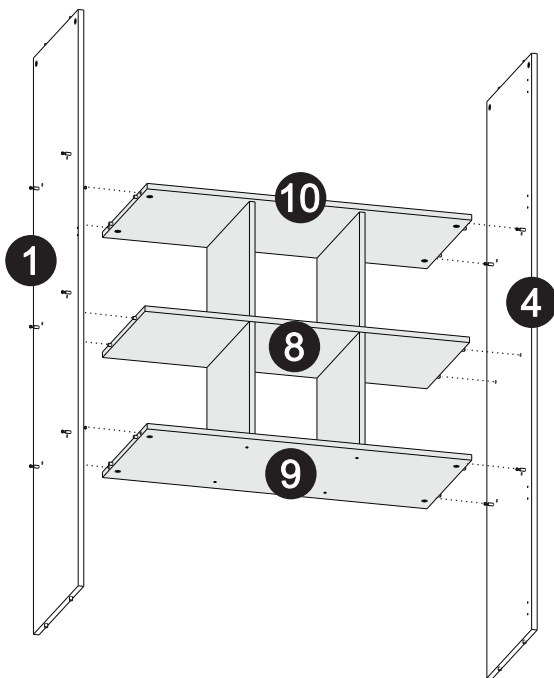
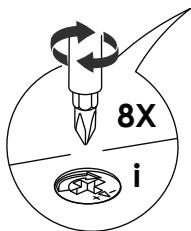

12

Passo
Paso
Step

FERRAMENTAS
HERRAMIENTAS/ TOOLS

3X

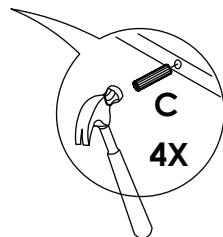
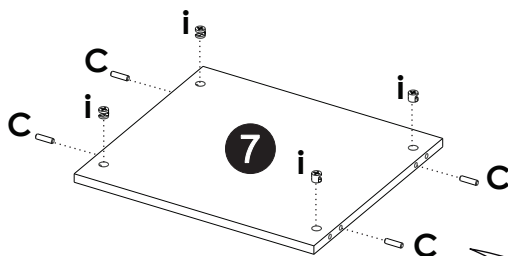
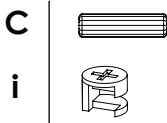

13

Passo
Paso
Step

FERRAMENTAS
HERRAMIENTAS/ TOOLS

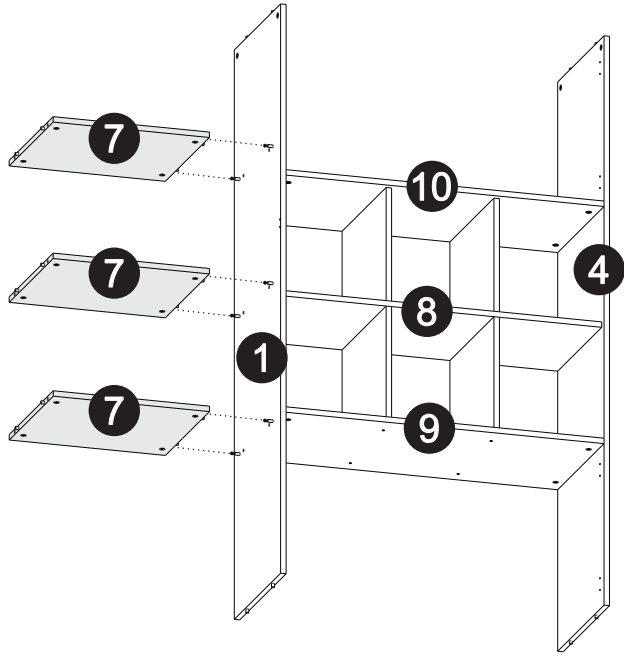
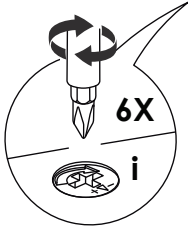

14

Passo
Paso
Step

FERRAMENTAS
HERRAMIENTAS/ TOOLS

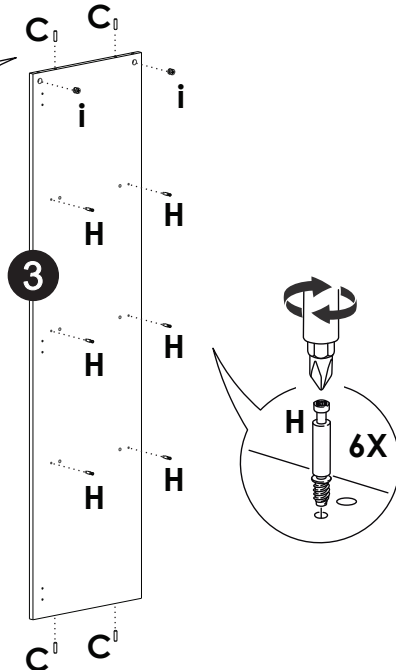
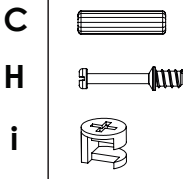
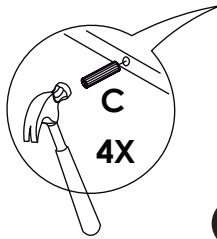

15

Passo
Paso
Step

FERRAMENTAS
HERRAMIENTAS/ TOOLS

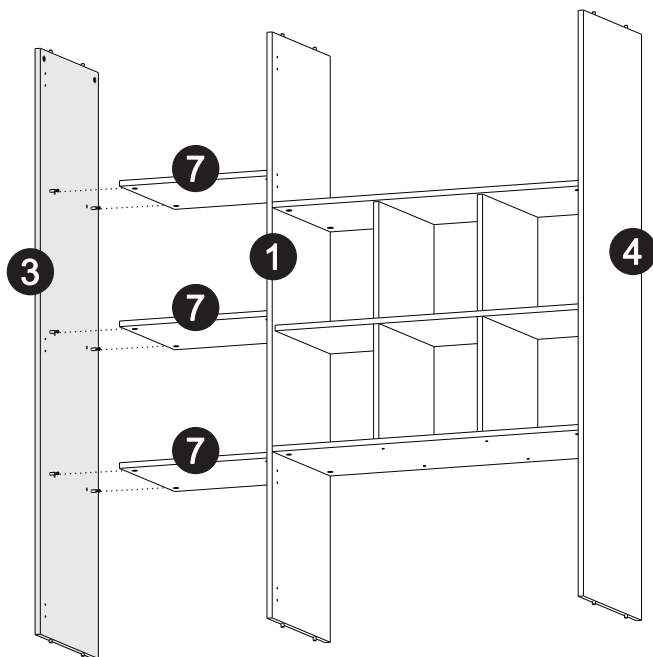
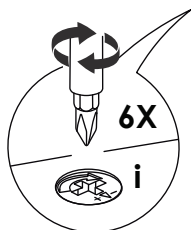

16

Passo
Paso
Step

FERRAMENTAS
HERRAMIENTAS/ TOOLS

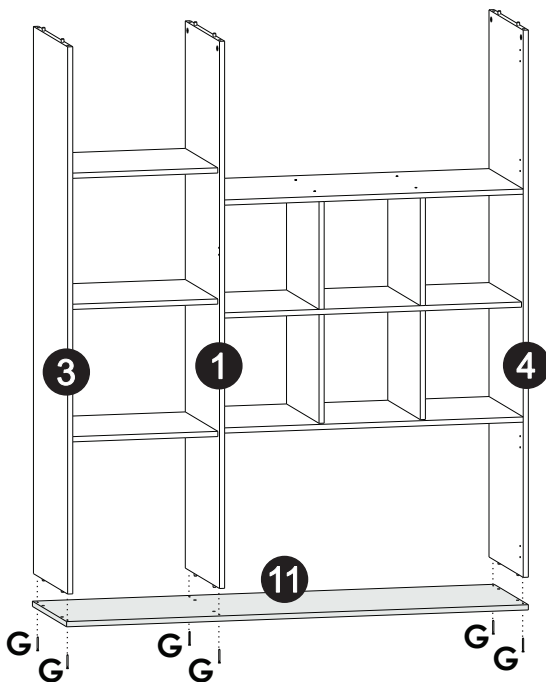
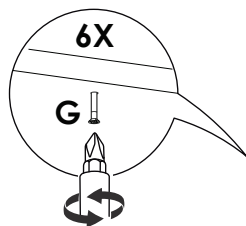

17

Passo
Paso
Step

FERRAMENTAS
HERRAMIENTAS/ TOOLS

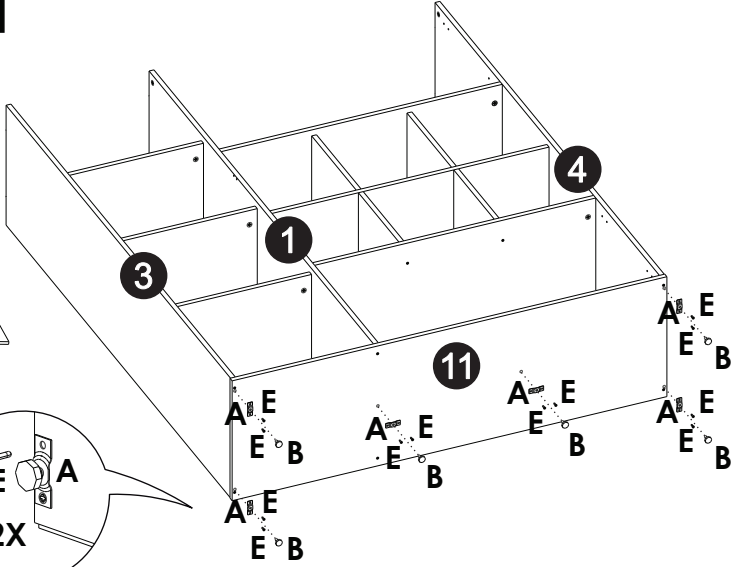
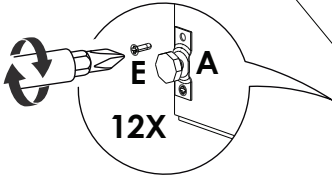
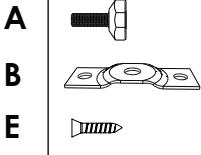

18

Passo
Paso
Step

FERRAMENTAS
HERRAMIENTAS/ TOOLS

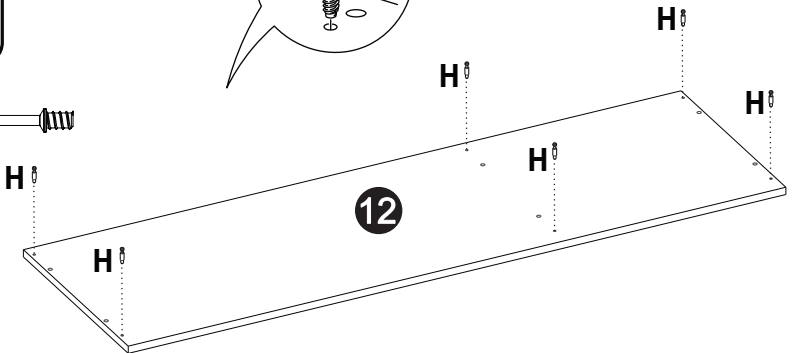
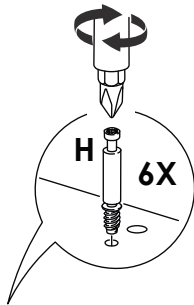
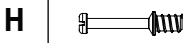

19

Passo
Paso
Step

FERRAMENTAS
HERRAMIENTAS/ TOOLS

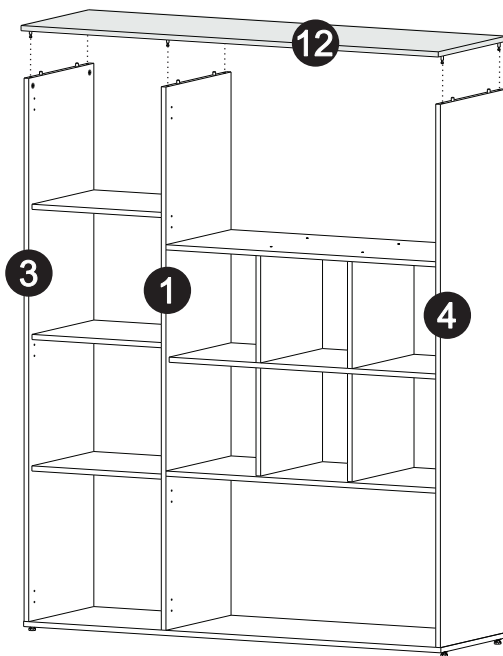
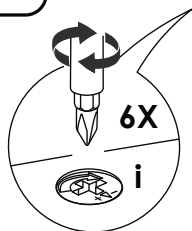

20

Passo
Paso
Step

FERRAMENTAS
HERRAMIENTAS/ TOOLS



J



M

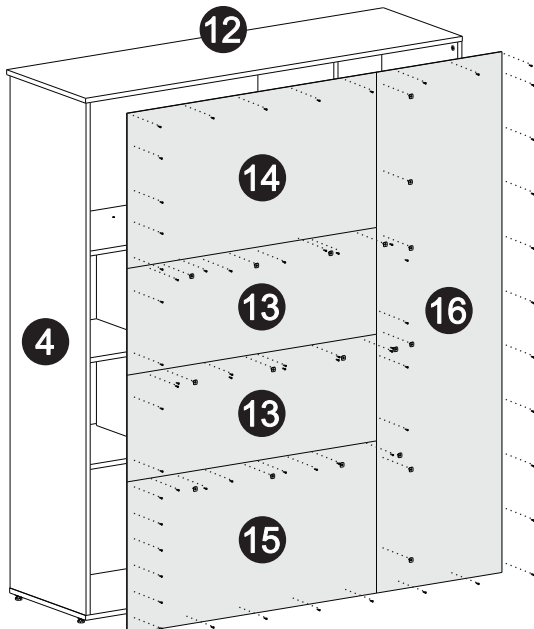
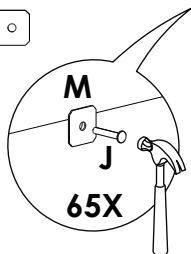

21

Passo
Paso
Step

4X

FERRAMENTAS
HERRAMIENTAS/ TOOLS

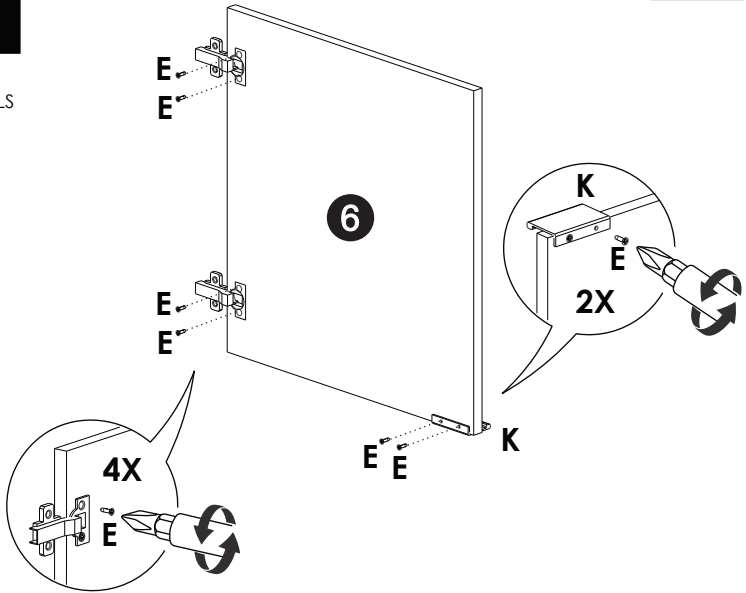
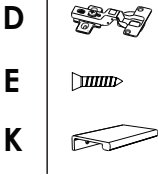

22

Passo
Paso
Step

FERRAMENTAS
HERRAMIENTAS/ TOOLS

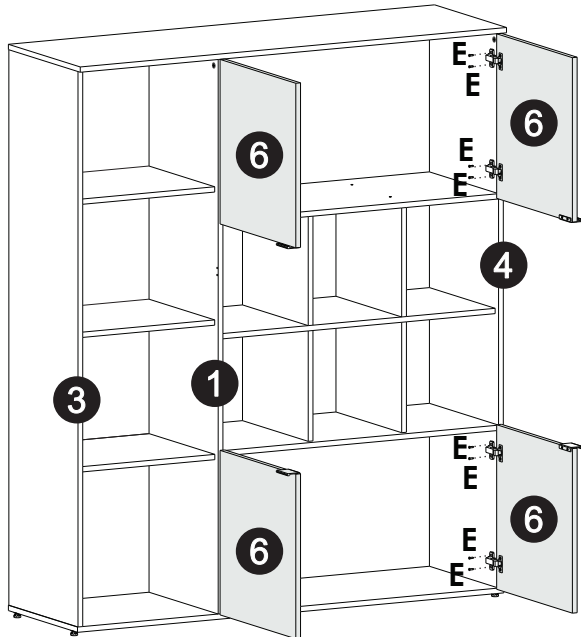
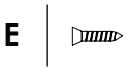

23

Passo
Paso
Step

FERRAMENTAS
HERRAMIENTAS/ TOOLS

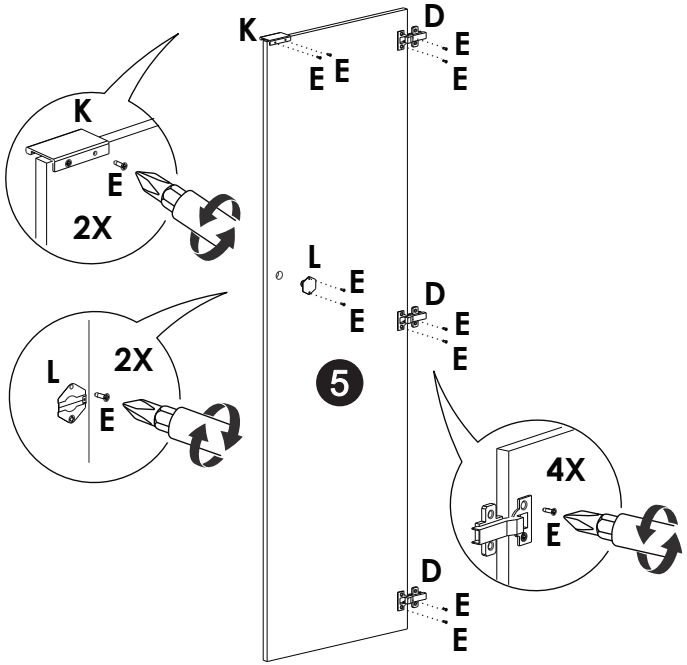
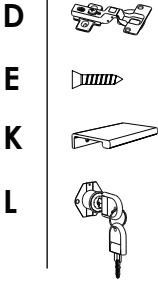

24

Passo
Paso
Step

FERRAMENTAS
HERRAMIENTAS/ TOOLS

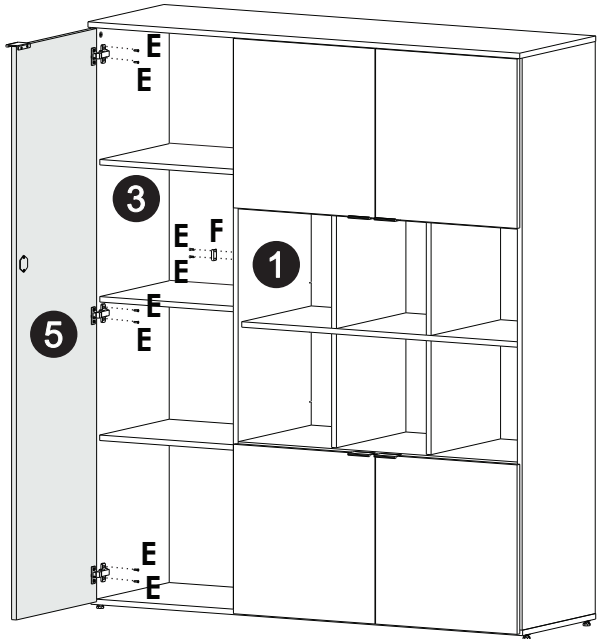
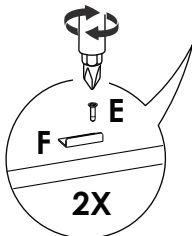
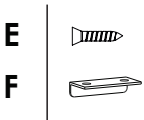

Garantia

- 1 - Nossos produtos possuem um prazo de garantia de 6 meses.
- 2 - A garantia referente as peças de acabamento sujeitas ao desgaste natural, ficarão restritas ao prazo legal de 90 dias.
- 3 - A empresa somente fará a reposição de partes e componentes dos produtos nos termos descritos abaixo e que comprovarem a existência do alegado defeito de material ou fabricação.
- 4 - A garantia é válida para defeitos de fabricação detectados após o recebimento dos produtos e torna-se nula quando:
 - Danos ocorridos durante o transporte ou montagem do produto, quando estes não tiverem sido executados pela empresa;
 - Problemas ocorridos por montagem em desacordo com o manual de instruções ou relacionados a adaptações e/ou alterações realizadas no produto;
 - Defeitos e desgastes no acabamento, partes e/ou peças ocorridos por uso intenso ou exposição a condições adversas e não previstos, tais como umidade excessiva, intempéries, maresia, frio e calor intensos, cupim e pragas de madeira em geral, sinistros, acidentes, quedas ou agentes da natureza.
 - Problemas ocorridos devido a condições inadequadas do local de instalação do produto, tais como pisos desnivelados, paredes pouco resistentes e fora do prumo, etc;
 - Danos causados por serviços ou consertos contratados pelo consumidor, descuido, maus tratos, limpeza e/ou manutenção em desacordo com as instruções contidas no manual;
- 5 - Todas as reclamações e defeitos observados durante o prazo da garantia serão atendidas mediante a apresentação da nota fiscal de compra e entrando em contato com nossa central de atendimento.
- 6 - A empresa reserva-se o direito de alterar as características gerais, técnicas e estéticas, introduzir melhoramentos a sua linha de produtos em qualquer momento, sem incorrer na obrigação de efetuar o mesmo nos produtos em estoque ou já vendidos.
- 7 - Em caso de troca total do produto completo ou de peças, a empresa efetuará o envio do mesmo em um prazo de 30 dias. Em caso de dúvidas, entre em contato através do nosso e-mail sac@compace.com.br ou pelo telefone (45) 3565-1450.

- 1 - Nuestros productos tienen un período de garantía de 6 meses.
- 2 - La garantía con respecto a las piezas de acabado sujetas a desgaste natural se limitará al plazo legal de 90 días.
- 3 - La compañía solo reemplazará partes y componentes de los productos como se describe a continuación y que demuestren la existencia del supuestodefecto en material o mano de obra.
- 4 - La garantía es válida para defectos de fabricación detectados al recibir los productos y se anula cuando:
 - Daños ocurridos durante el transporte o montaje del producto, cuando la empresa no los realizó;
 - Problemas causados por el ensamble en desacuerdo con el manual de instrucciones o relacionados con adaptaciones y / o cambios realizados al producto;
 - Defectos de acabado y desgaste, partes y / o partes que se han producido debido al uso intensivo o la exposición a condiciones adversas e imprevistas, como la humedad, clima excesivo, clima inclemente, aire salado, frío y calor, termitas y plagas de madera en general, accidentes, accidentes, caídas o agentes de la naturaleza.
 - Problemas debidos a condiciones inadecuadas en la ubicación de instalación del producto, como pisos irregulares, paredes poco resistentes y exteriores plomada, etc.
 - Daños causados por el servicio o reparación contratada por el consumidor, descuido, maltrato, limpieza y / o mantenimiento no conforme a las instrucciones contenido en el manual;
- 5 - Todos los reclamos y defectos observados durante el período de garantía se cumplirán presentando la factura de compra e ingresando contacte nuestro centro de servicio.
- 6 - La empresa se reserva el derecho de modificar las características generales, técnicas y estéticas, realizar mejoras en su línea de productos en cualquier momento sin incurrir en la obligación de hacer lo mismo para productos en stock o ya vendidos.
- 7 - En caso de intercambio completo del producto completo o partes, la compañía lo enviará dentro de los 30 días. Si tiene alguna pregunta, contáctenos por correo electrónico sac@compace.com.br o por teléfono al (45) 3565-1450.

- 1 - Our products have a warranty period of 6 months.
- 2 - The warranty regarding finishing parts subject to natural wear and tear will be restricted to the legal term of 90 days.
- 3 - The company will only replace parts and components of the products as described below and that prove the existence of the alleged defect in material or workmanship.
- 4 - The warranty is valid for manufacturing defects detected upon receipt of the products and becomes void when:
 - Damages occurred during the transportation or assembly of the product, when these were not performed by the company;
 - Problems caused by assembly in disagreement with the instruction manual or related to adaptations and / or changes made to the product;
 - Defects and wear on finish, parts and / or parts that have occurred due to heavy use or exposure to adverse and unforeseen conditions such as moisture, excessive weather, inclement weather, salty air, cold and heat, termite and wood pests in general, accidents, accidents, falls or nature agents.
 - Problems due to improper conditions in the product installation location, such as uneven floors, poorly resilient walls and outside plumb, etc;
 - Damage caused by service or repair contracted by the consumer, carelessness, mistreatment, cleaning and / or maintenance not in accordance with the instructions contained in the manual;
- 5 - All claims and defects observed during the warranty period will be met by presenting the purchase invoice and entering contact our service center.
- 6 - The company reserves the right to change the general, technical and aesthetic characteristics, make improvements to its product line in any without incurring the obligation to do the same for products in stock or already sold.
- 7 - In case of complete exchange of the complete product or parts, the company will send it within 30 days. If you have any questions, please contact us by e-mail sac@compace.com.br or by phone at (45) 3565-1450.

Dicas para prolongar a vida útil do seu móvel:

- ☑ **Limpeza** - use um pano macio, levemente umedecido com água. É possível o uso de detergente neutro, ou sabão neutro.

Limpeza: use un paño suave, ligeramente humedecido con Agua. Es posible utilizar detergente neutro, o jabón neutro

Cleaning - use a soft cloth, slightly dampened with Water. It is possible to use neutral detergent, or neutral soap.

- ☑ **Manutenção** - para garantir estabilidade e durabilidade, é recomendado reapertar os parafusos de tempos em tempos.

Mantenimiento: para garantizar la estabilidad y la durabilidad, es recomienda volver a apretar los tornillos de vez en cuando.

Maintenance - to ensure stability and durability, it is recommended to retighten the screws from time to time.

- ☑ **Temperatura** - a falta de ventilação e excesso de calor podem prejudicar a durabilidade e acabamento do produto.

Temperatura: la falta de ventilación y el exceso de calor pueden perjudicar la durabilidad y el acabado del producto.

Temperature - lack of ventilation and excess heat can impair the durability and finish of the product.