

ASSEMBLY INSTRUCTIONS

Ref.: 200706 - ELB0076.01 | Review 01

INSTRUCTIONS DE MONTAGE | MANUAL DE ARMADO | ESQUEMA DE MONTAGEM

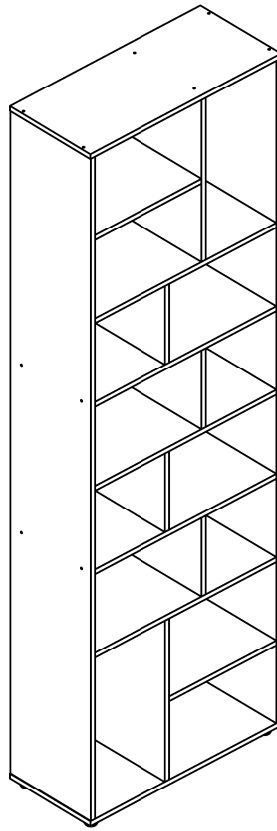

YOU WILL NEED

TU AURAS BESOIN DE | NECESITARÁ | VOCÊ VAI PRECISAR

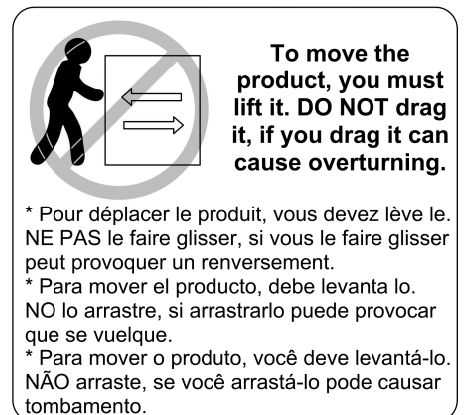
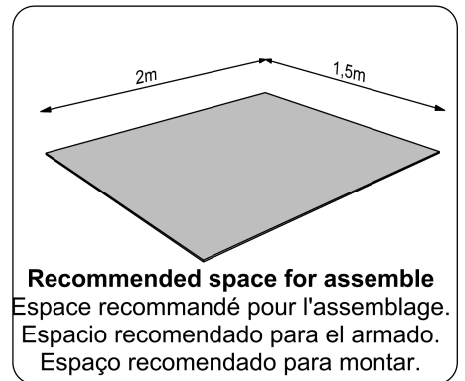
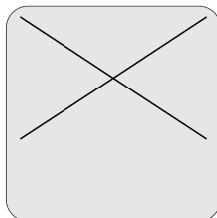
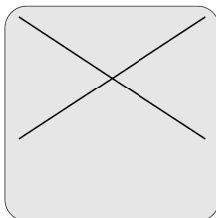
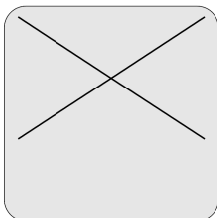
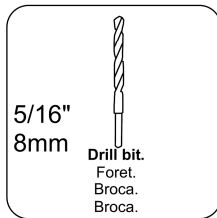
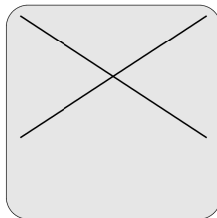
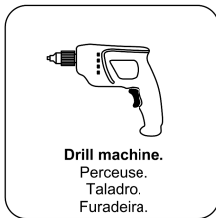
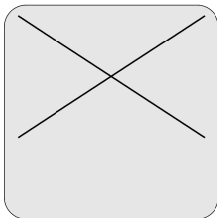
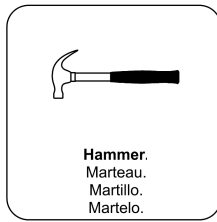
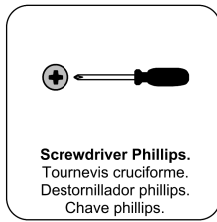
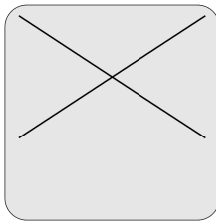
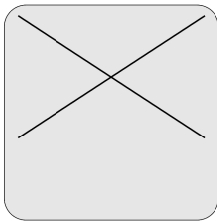







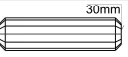

Tools not included

Outils non inclus | Herramientas no incluidas | Ferramentas não inclusas

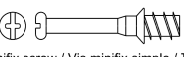
ACCESSORIES IDENTIFICATION

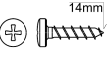
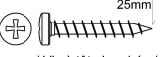
IDENTIFICATION DES ACCESSOIRES | IDENTIFICACIÓN DE ACCESORIOS
IDENTIFICAÇÃO DOS ACESSÓRIOS

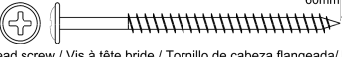
A		Qty./Qtd. 60
Wooden dowel / Chevilles en bois / Taquete / Cavilha		
B		Qty./Qtd. 8
Structural screw / Vis à tête structurelle / Tornillo estructural / Parafuso Estrutural		
BC		Qty./Qtd. 4
Plastic foot / Pied en Plastique / Pie plástico / Sapata Plástica		
C		Qty./Qtd. 17
Structural screw / Vis à tête structurelle / Tornillo estructural / Parafuso Estrutural		
G		Qty./Qtd. 5
Simple minifix screw / Vis minifix simple / Tornillo minifix simple / Haste Minifix Simples		
H		Qty./Qtd. 5
Drum lock / Verrouillage du tambour / Tambor minifix / Tambor de Minifix		
J		Qty./Qtd. 56
Nail / Ongle / Clavo / Prego		
N		Qty./Qtd. 2
Pan head screw / Vis à tête bombée / Tornillo de pan / Parafuso Panela		
O		Qty./Qtd. 4
Pan head screw / Vis à tête bombée / Tornillo de pan / Parafuso Panela		
R		Qty./Qtd. 1
Metalic bracket / Support métallique / Soporte de metal / Suporte de Metal		
S		Qty./Qtd. 1
Bushing / Douille expansive / Tapón / Bucha Plástica		
T		Qty./Qtd. 1
Flanged head screw / Vis à tête bride / Tornillo de cabeza flangeada / Parafuso flangeado		

PARTS IDENTIFICATION

IDENTIFICATION DES PIÈCES | IDENTIFICACIÓN DE PIEZAS | IDENTIFICAÇÃO DAS PEÇAS

01	Top Plan de Travail Tapa Tampo	Qty./Qtd. 01
02	Shelf Étagère Repisa Prateleira	Qty./Qtd. 02
03	Center Base Base Centrale Base Central Base Central	Qty./Qtd. 03
04	Intermediate Base Base Intermédiaire Base Intermedia Base Intermediária	Qty./Qtd. 02
05	Top Division Division Supérieur División Superior Divisória Superior	Qty./Qtd. 01
06	Division Division División Divisória	Qty./Qtd. 04
07	Bottom Division Division Inférieur División Inferior Divisória Inferior	Qty./Qtd. 01
08	Bottom Base Base Inférieure Base Inferior Base Inferior	Qty./Qtd. 01
09	Side Côté Lateral Lateral	Qty./Qtd. 02
11	Center Backboard Panneau Centrale Fondo Central Costa Central	Qty./Qtd. 04
12	Backboard Panneau Trasero Fondo Trasero Costa	Qty./Qtd. 02

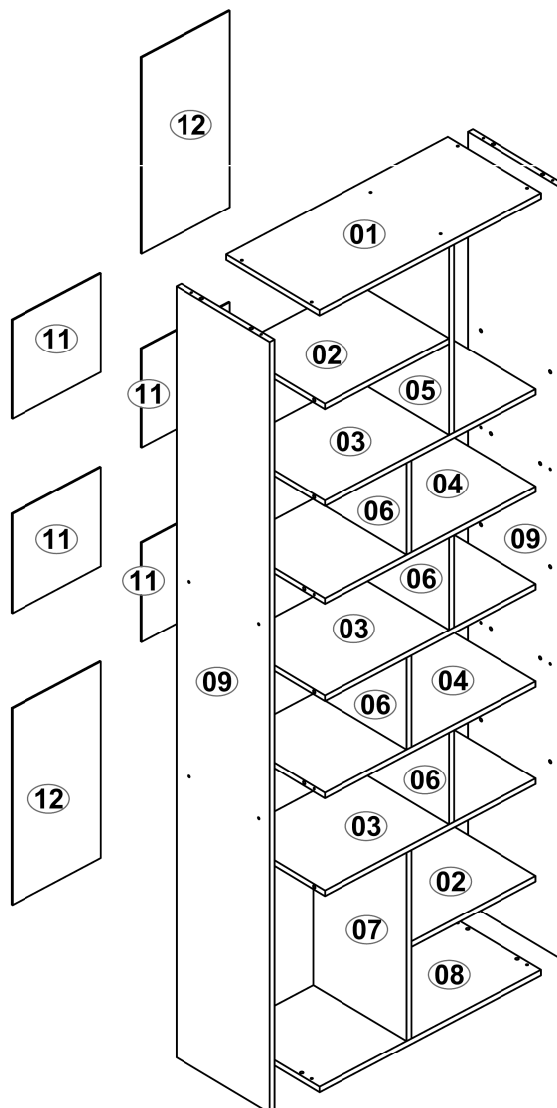

PRE-ASSEMBLY - PRÉ-ASSEMBLAGE - PRE-ARMADO
PRÉ-MONTAGEM

01 -

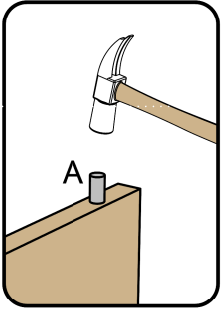

2x

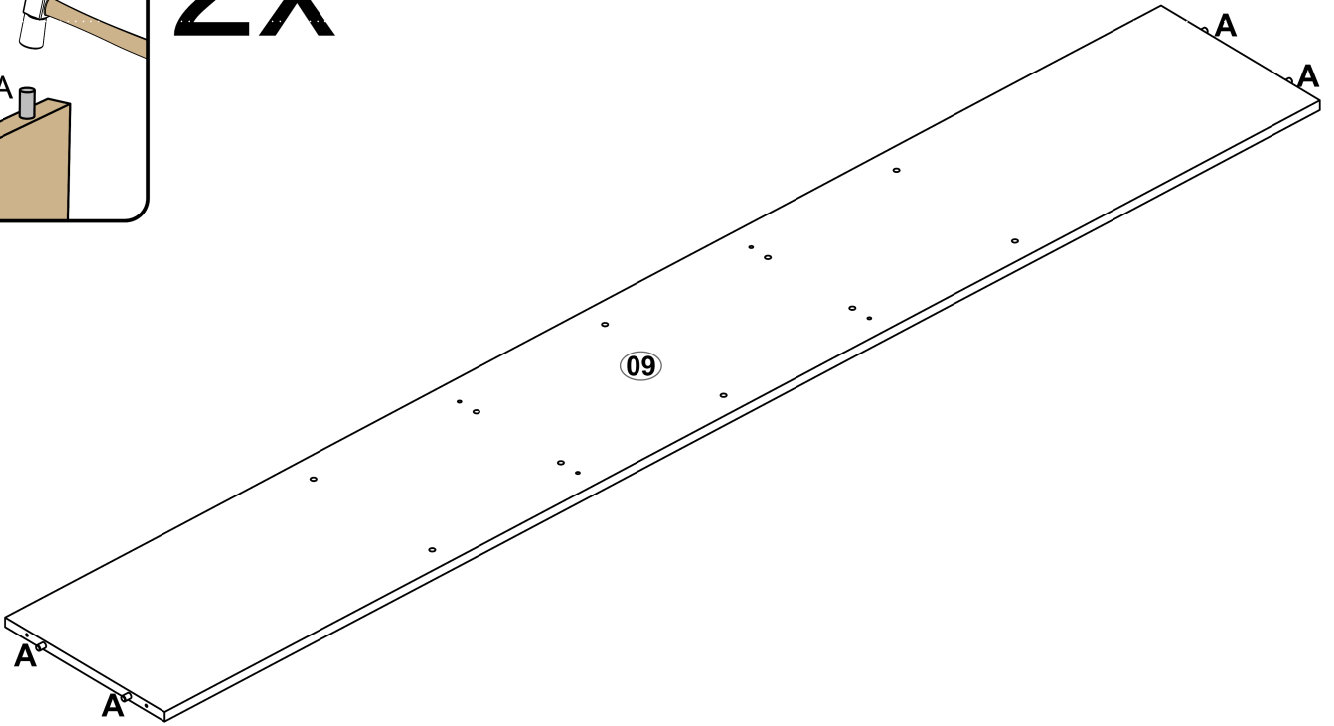

02 -

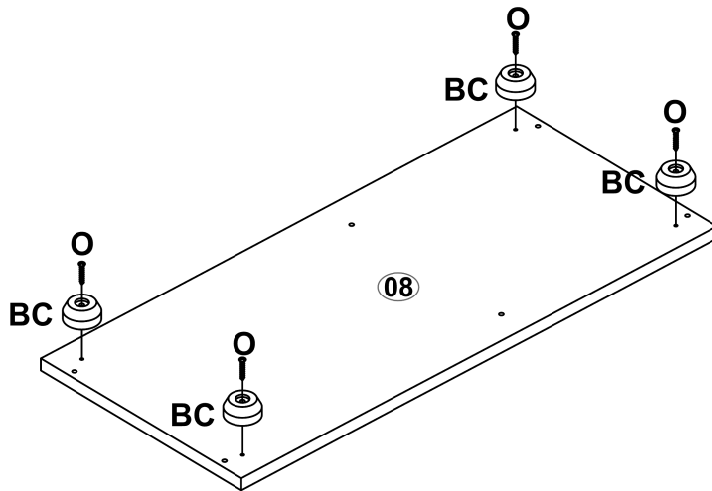

03 -

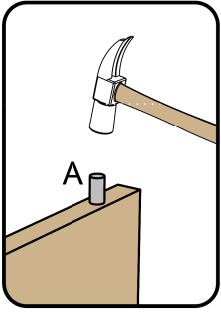

4x

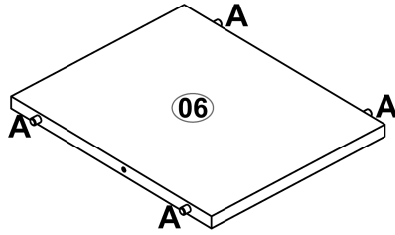

04 -

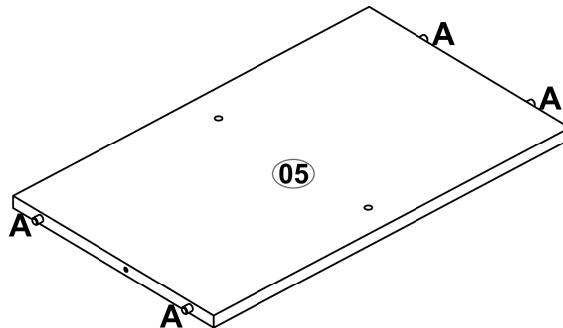
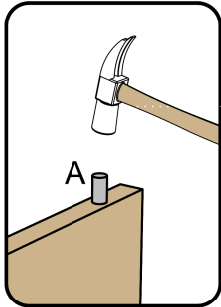

05 -

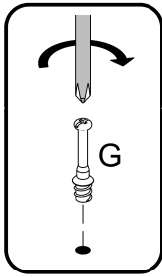
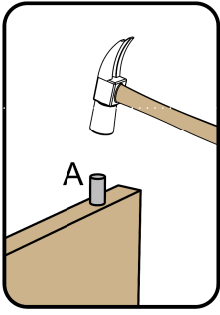

3x

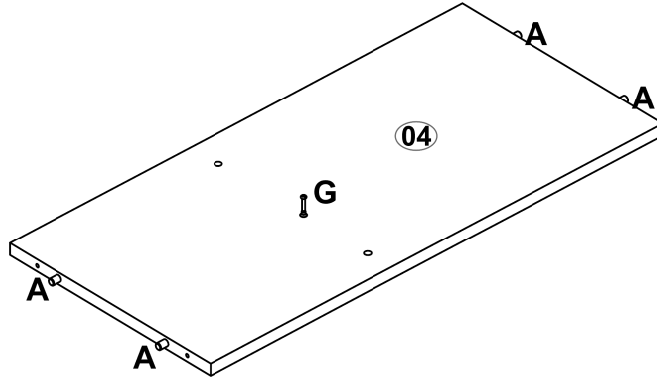

06 -

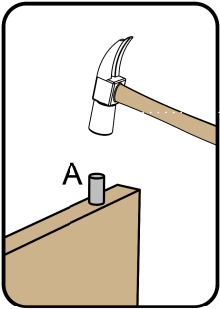

2x

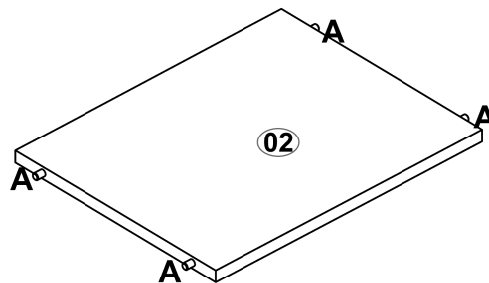

07 -

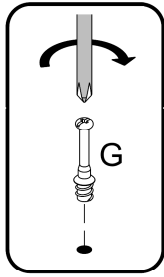
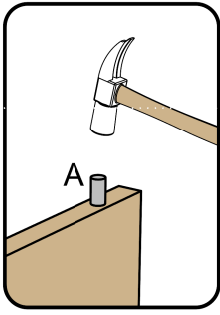

2x

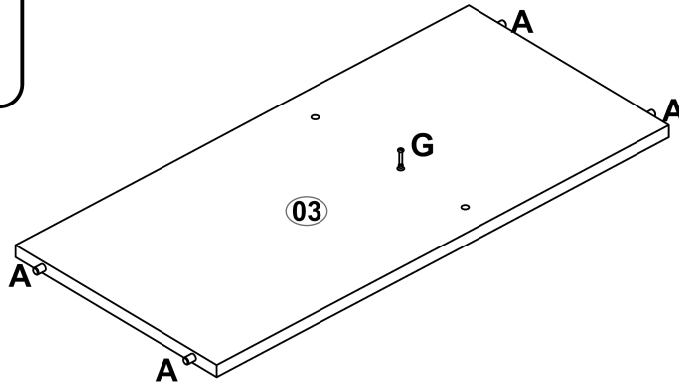

ASSEMBLY - MONTAGE - ARMADO - MONTAGEM

08 -

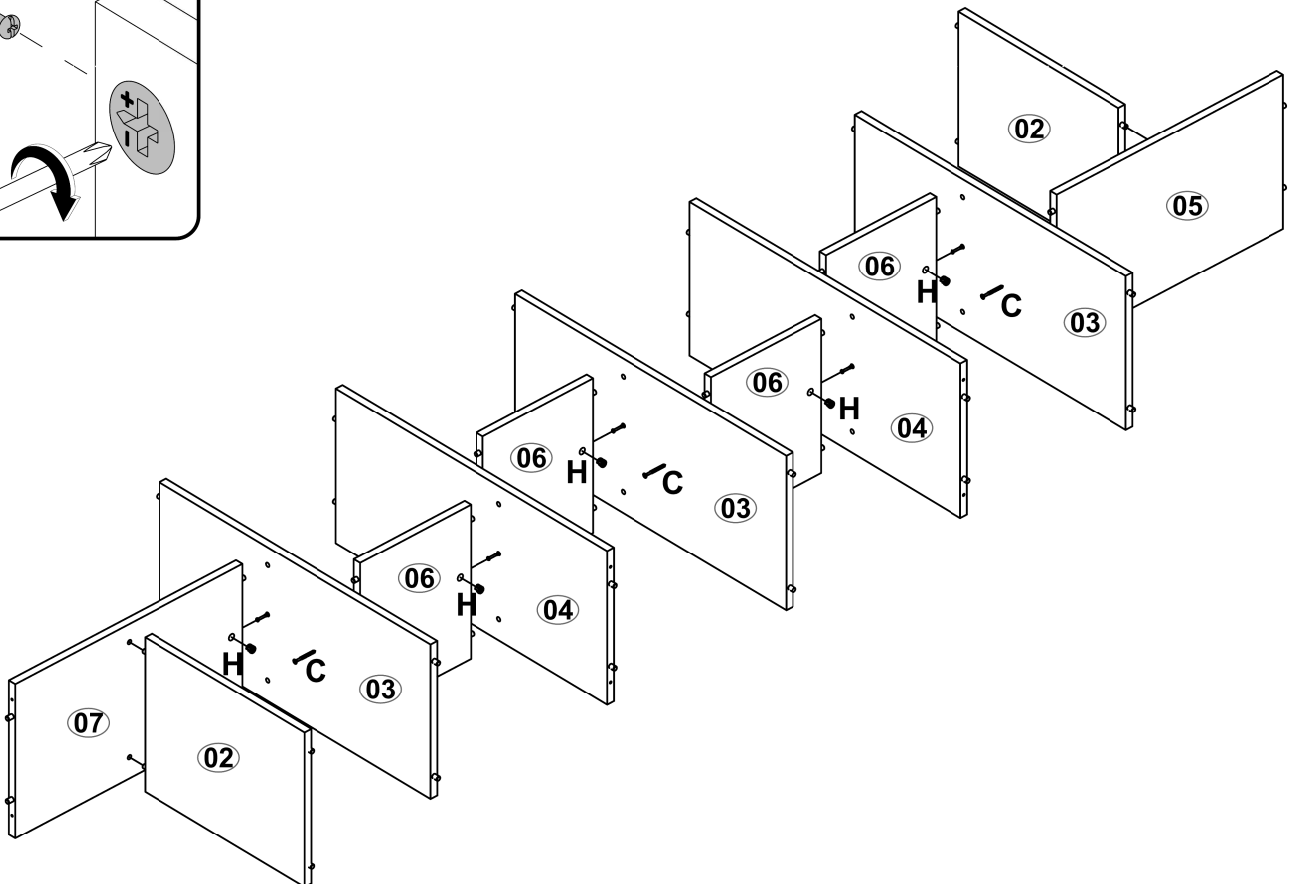
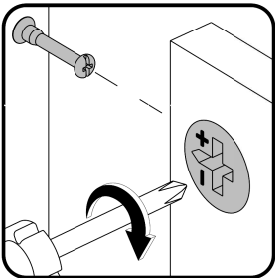

09 -

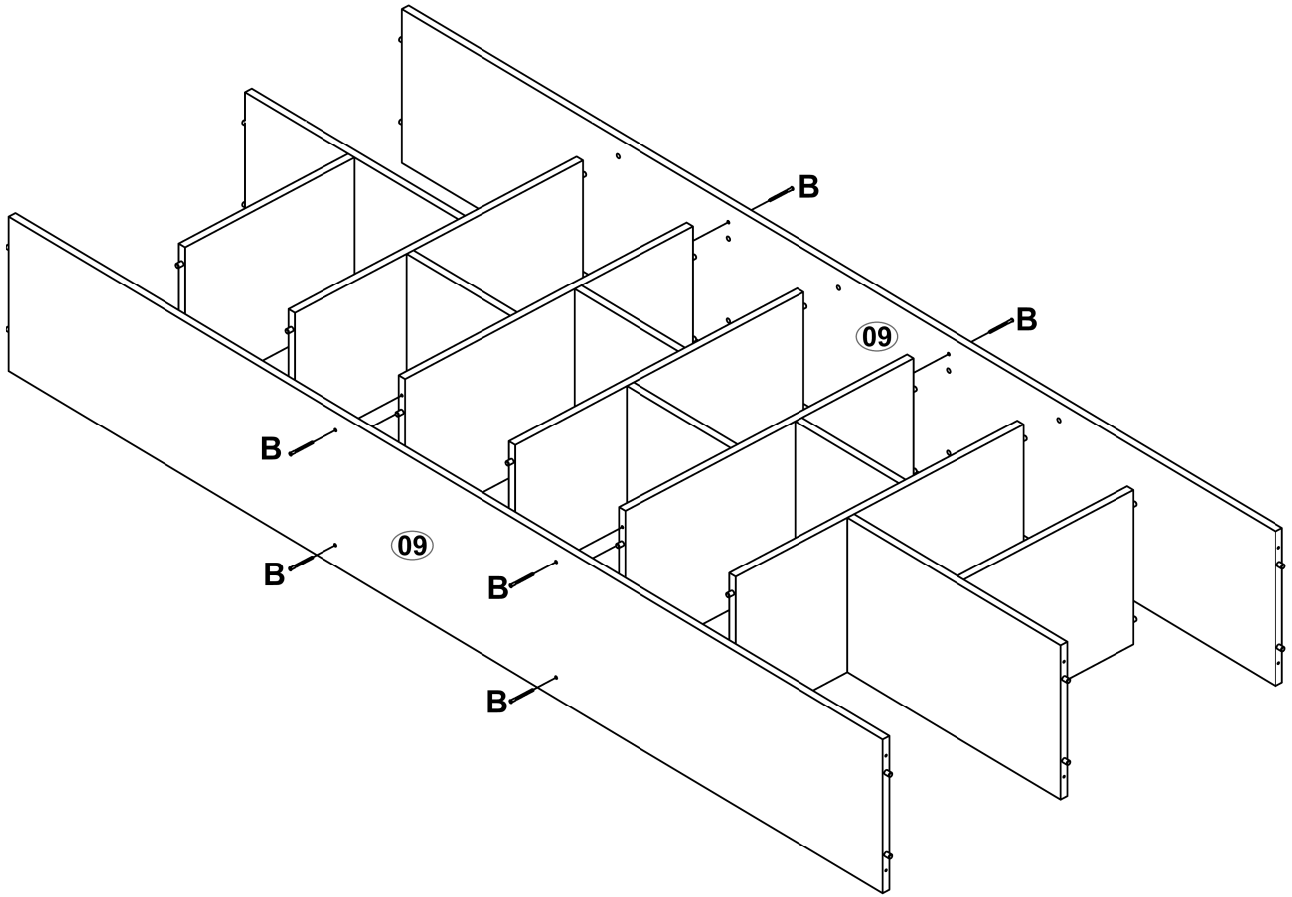

10 -

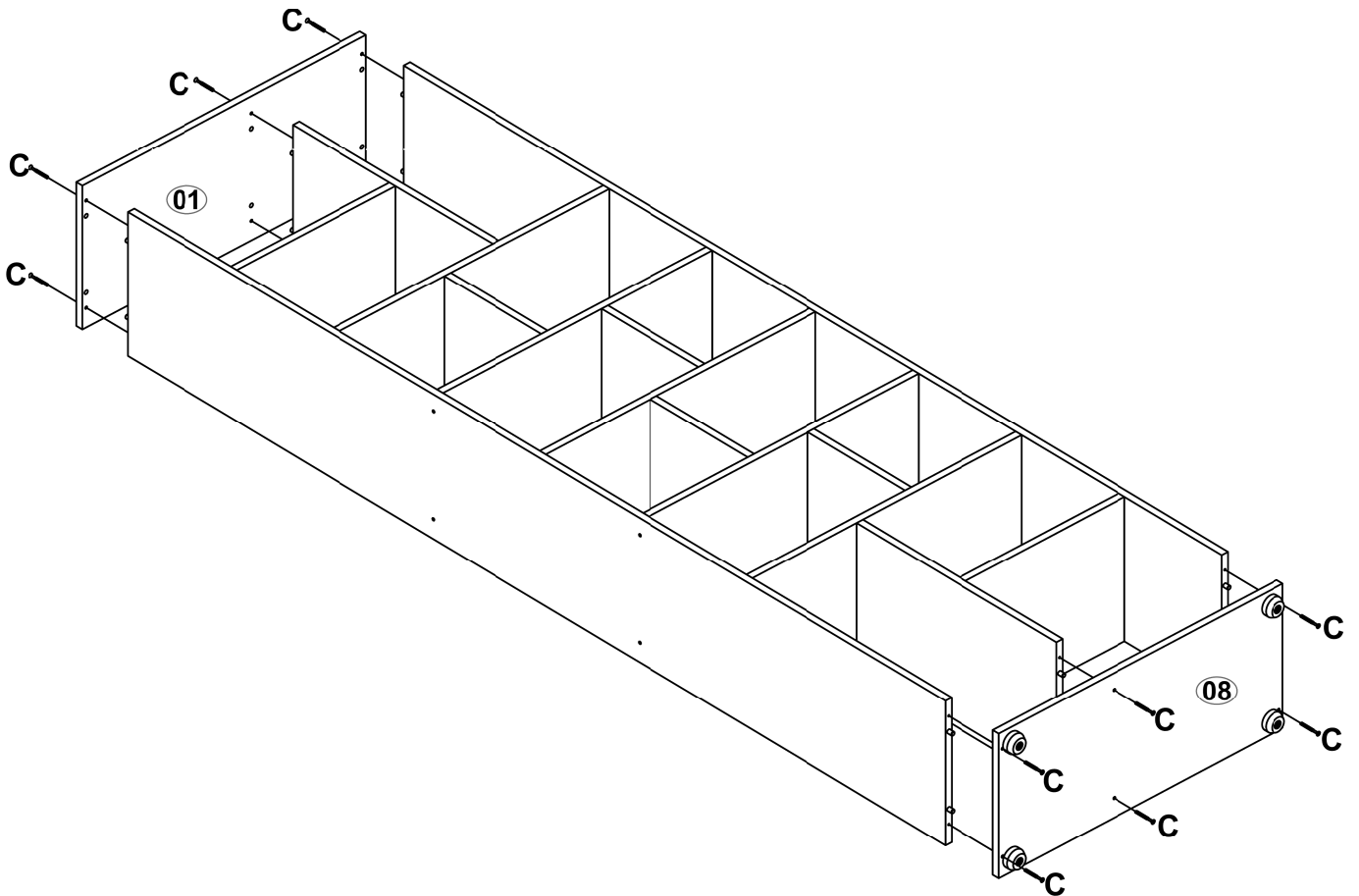

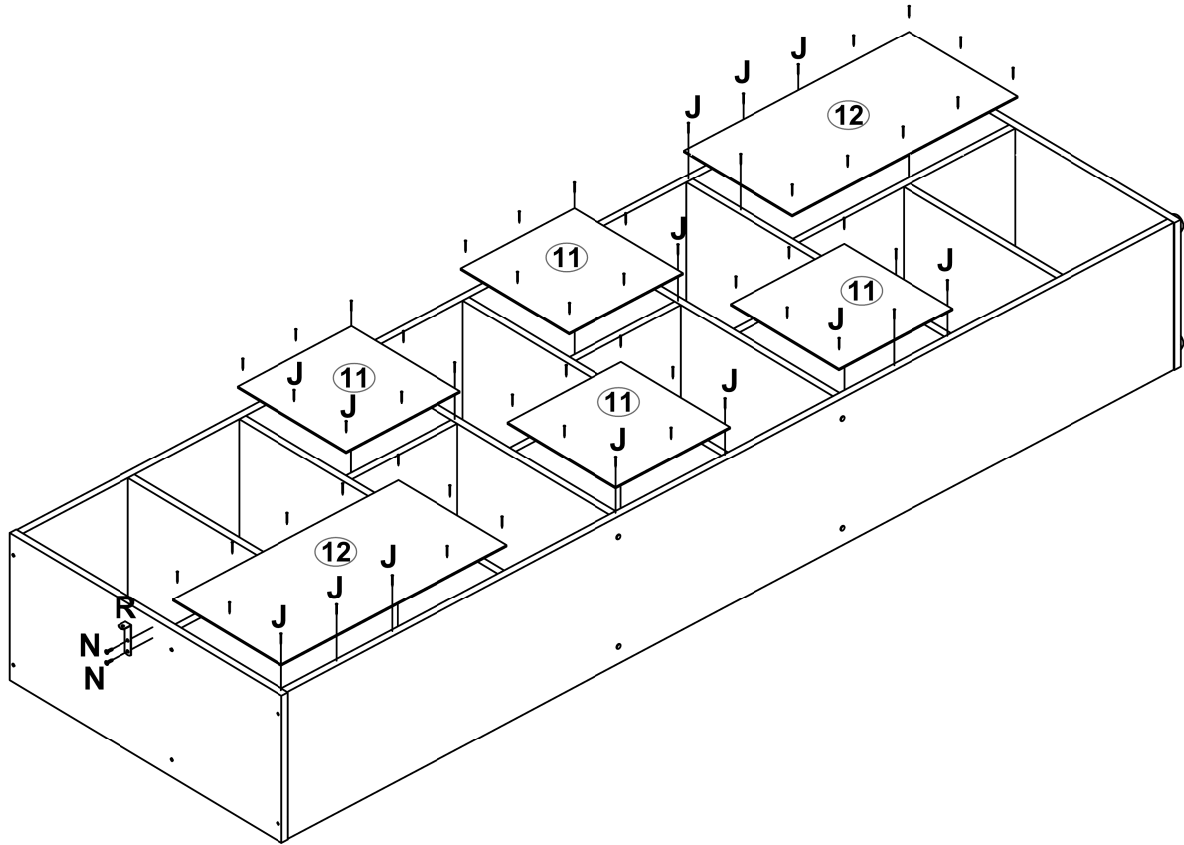

11 -

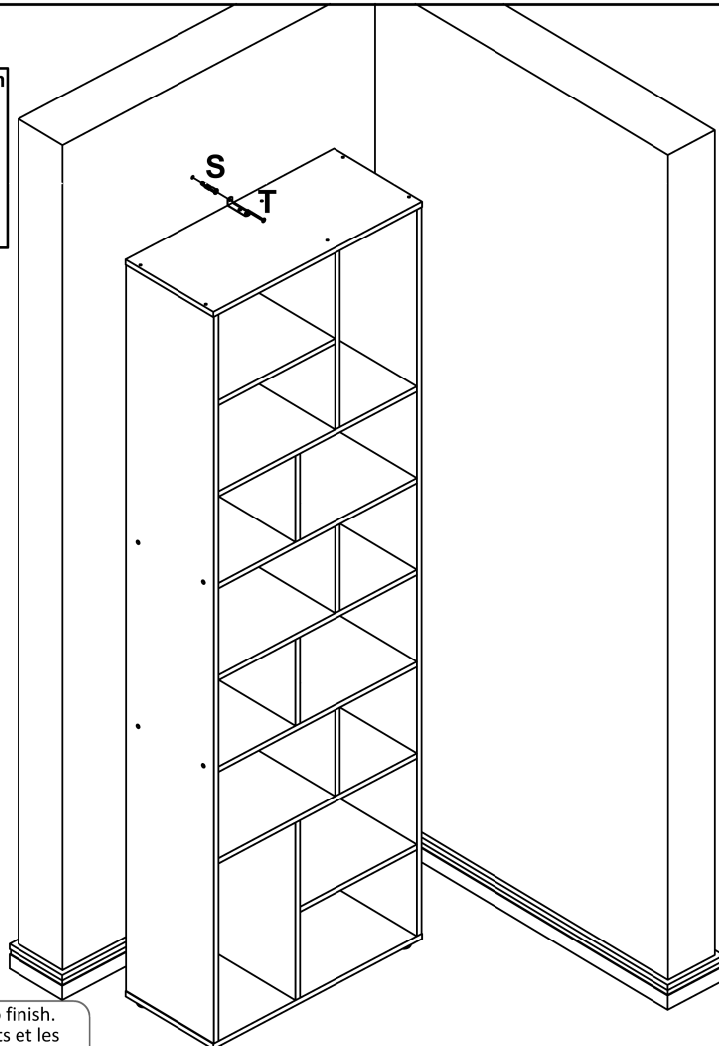
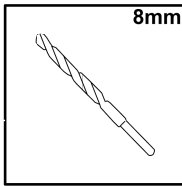
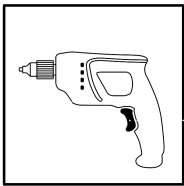

12 -



 ***Note:** Use the stickers and caps to finish.
***Remarque:** Utiliser les autocollants et les capuchons pour terminer la finition.
***Nota:** Utilice los adhesivos y tapas para finalizar el acabado.
 ***Nota:** Utilize os adesivos e tampas para finalizar o acabamento.