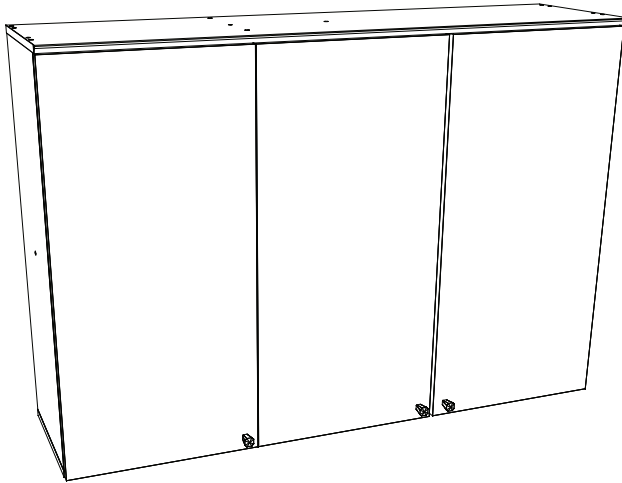
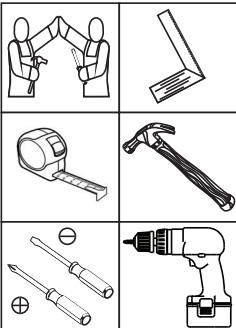

HENNInd. e Com. de Móveis Henn
Mondai - SC - Brasil

☎ +55 49 3674.3500

📷 📱 @moveishenn
www.henn.com.br**INSTRUÇÕES DE
MONTAGEM**INSTRUCCIONES DE MONTAJE
ASSEMBLY INSTRUCTIONS**Aereo 03 Portas 1200mm Requite |**
Aire 03 Puertas 1200mm Requite | Air 03 Doors 1200mm Requite**C636-128 Nature**
C636-217 Nature/Areia**Requisitos para montagem**
Requisitos para la montaje
Assembly Requirements

Imagens meramente ilustrativas,
não acompanha o produto.
Imágenes ilustrativas, no incluidas
con el producto.
Illustrative images, not included
with the product.

AVISO

Para limpeza de seu móvel, use uma franela seca ou umedecida, e não utilize produtos químicos que possam danificar seu produto.

SISTEMA DE MONTAGEM

O sistema de montagem dos produtos, funciona de acordo com a ordem crescente dos números indicados no desenho. Ex: 01, 02, 03, 04... até a conclusão da montagem.

ASSISTÊNCIA TÉCNICA

Para solicitação de Assistência Técnica você consumidor deverá entrar em contato com o Lojista o qual você realizou a compra deste produto e solicitar a assistência técnica das peças avariadas. A garantia abrange todas as peças, partes e componentes que eventualmente venham apresentar defeito de fabricação no prazo de 03 (três) meses, contando a partir da entrega do produto ao consumidor, mediante nota fiscal de compra. Se houver qualquer alteração na estrutura do produto ou ocorrer defeito por negligência do montador/consumidor em relação a instrução de montagem e manuseio, não será fornecido assistência técnica gratuita.

ADVERTENCIA

Para limpieza de su móvil, use una franela seca o húmeda, y no utilice productos químicos que puedan dañar su producto.

SISTEMA DE MONTAJE

El sistema de montaje de los productos funciona de acuerdo con el orden creciente de los números indicados en el dibujo. Ej.: 01, 02, 03, 04... hasta la conclusión del montaje.

ASISTENCIA TÉCNICA

Para solicitar Asistencia Técnica, el consumidor debe comunicarse con el Comercio que usted realizó la compra de este producto y solicita asistencia técnica para las partes dañadas. La garantía cubre todas las partes, piezas y componentes que eventualmente puedan presentar defecto de fabricación en el plazo de 03 (tres) meses, contados a partir de la entrega del producto al consumidor, mediante factura de compra. Si se produce algún cambio en la estructura del producto o se produce un defecto por negligencia del montador/consumidor en relación con las instrucciones de montaje y manipulación, no se prestará asistencia técnica gratuita.

NOTICE

To clean your furniture, use a dry or wet cloth, and do not use chemicals that may damage your product.

ASSEMBLY SYSTEM

The products' assembly system works according to the increasing order of the indicated numbers. For example: 01, 02, 03, 04 ... to the end of the assembly.

TECHNICAL ASSISTANCE

To request Technical Assistance, the consumer must contact the retailer from whom you purchased this product and request technical assistance for the damaged parts. The warranty covers all parts, parts and components that may eventually present a manufacturing defect within a period of 03 (three) months, counting from the delivery of the product to the consumer, by means of a purchase invoice. If there is any change in the structure of the product or defect occurs due to negligence of the assembler/consumer in relation to the assembly and handling instruction, free technical assistance will not be provided.

ACESSÓRIOS | ACCESORIOS | ACCESSORIES

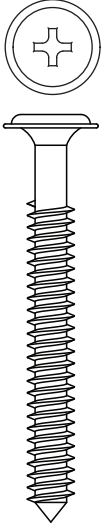
A  **x3**

B  **x16**

C  **x3**

D  **x4**

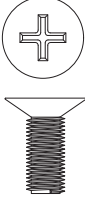
E  **x4**

F  **x42**

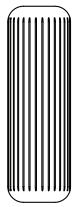
G  **x24**

H  **x66**

I  **x21**

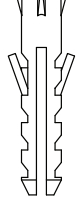
J  **x3**

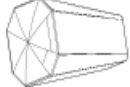
K  **x3**

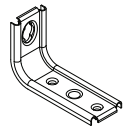
L  **x3**

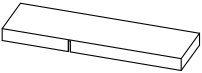
M  **x3**

N  **x18**

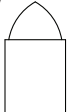
O  **x2**

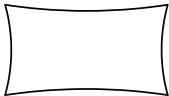
P  **x2**

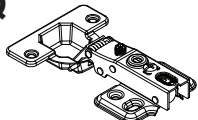
Q  **x6**

R  **x1**

Parafusos em escala
Tornillos escalados
Scaled screws **1:1**

 Os parafusos (D/E) devem ser usados somente quando este módulo for acoplado a outro módulo componível Henn.

 Los tornillos (D/E) se debe utilizar sólo cuando el módulo está conectado a otro módulo componible Henn.

 Screws (D/E) are to be used only when this module is mated to another Henn buildable module.

LISTA DE PEÇAS | LISTA DE PIEZAS | LIST OF PIECES

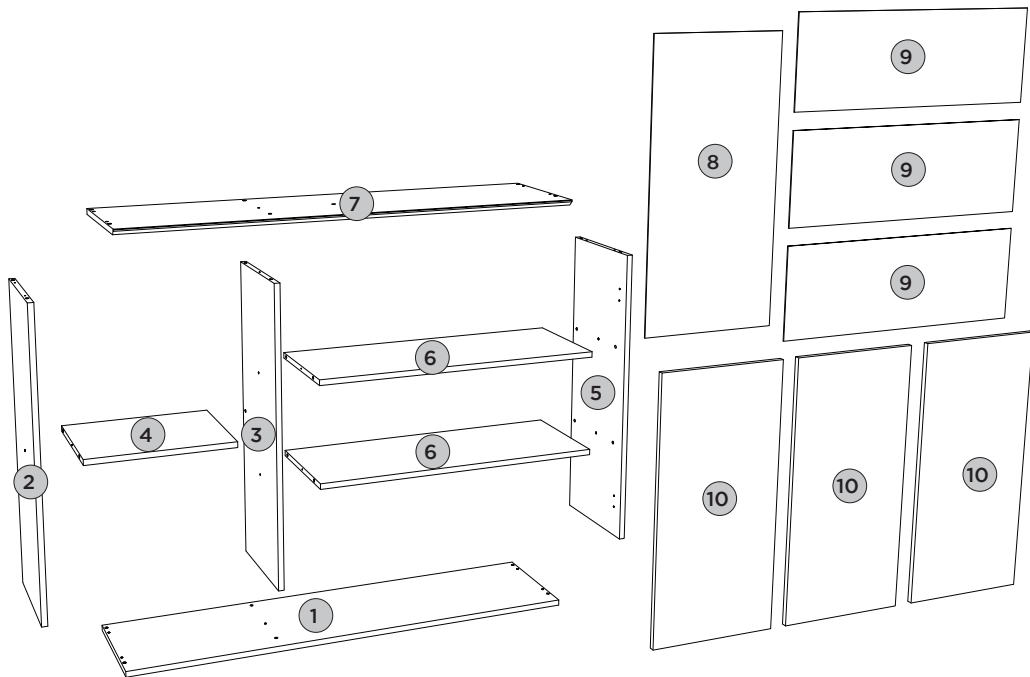

Item	Caixa Caja Box	Qty Ctd Qty	Descrição Descripción Description	Dimensões (mm) Dimensiones (mm) Dimensions (mm)		
				Comprimento Largo Length	Largura Ancho Width	Espessura Grosor Thickness
1	1/1	1	BASE BASE BASE	1200	295	15
2	1/1	1	LATERAL ESQUERDA LATERAL IZQUIERDA LEFT SIDE	800	295	15
3	1/1	1	DIVISÃO DIVISIÓN DIVISION	800	295	15
4	1/1	1	PRATELEIRA MENOR ESTANTE MÁS PEQUEÑO SMALLER SHELF	382	295	15
5	1/1	1	LATERAL DIREITA LATERAL DERECHA RIGHT SIDE	800	295	15
6	1/1	2	PRATELEIRA ESTANTE SHELF	772	295	15
7	1/1	1	TAMPO CUBRIR COVER	1200	322	15
8	1/1	1	FUNDO LATERAL FONDO LATERAL SIDE BACKGROUND	824	401	3
9	1/1	3	FUNDO FONDO BACKGROUND	791	274	3
10	1/1	3	PORTA PUERTA DOOR	813	396	15



PASSO 1

ITM/C636-

PEÇAS REQUERIDAS

2	LATERAL ESQUERDA	x1
3	DIVISÃO	x1
4	PRATELEIRA MENOR	x1
5	LATERAL DIREITA	x1
6	PRATELEIRA	x2

ACESSÓRIOS REQUERIDOS

G		24
P		

FERRAMENTAS NECESSÁRIAS

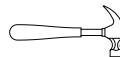

Utilizar o sachê de cola (P) em todas as cavilhas (G) do produto.

Con el pegamento sobre (P) en todos los pernos (G) producto.

Use the glue sachet (P) on all the pegs (G) of the product.

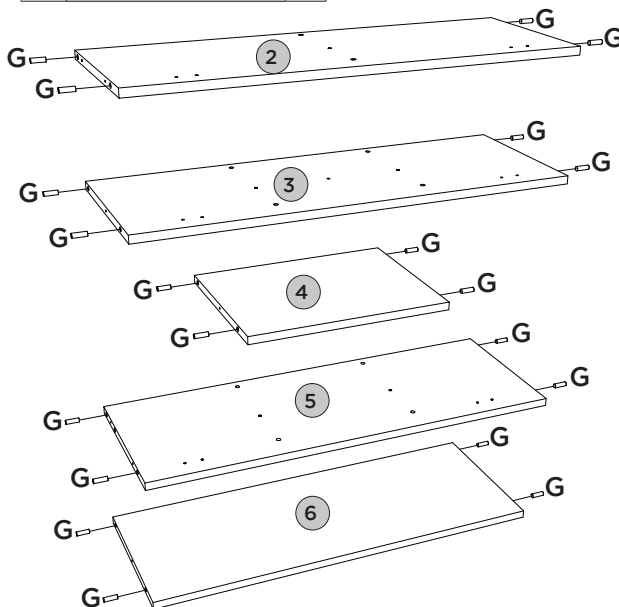



PASSO 2

PEÇAS REQUERIDAS

1	BASE	x1
2	LATERAL ESQUERDA	x1
3	DIVISÃO	x1
4	PRATELEIRA MENOR	x1

ACESSÓRIOS REQUERIDOS

B		05
P		

FERRAMENTAS NECESSÁRIAS

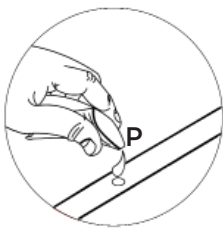
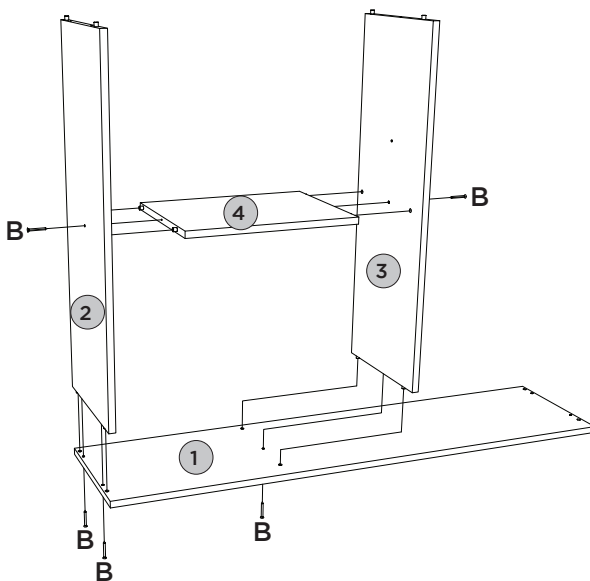
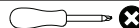





PASSO 3

ITM/C636-

PEÇAS REQUERIDAS

5	LATERAL DIREITA	x1
6	PRATELEIRA	x2
7	TAMPO	x1

ACESSÓRIOS REQUERIDOS

B			11
P			

FERRAMENTAS NECESSÁRIAS

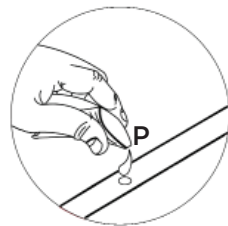
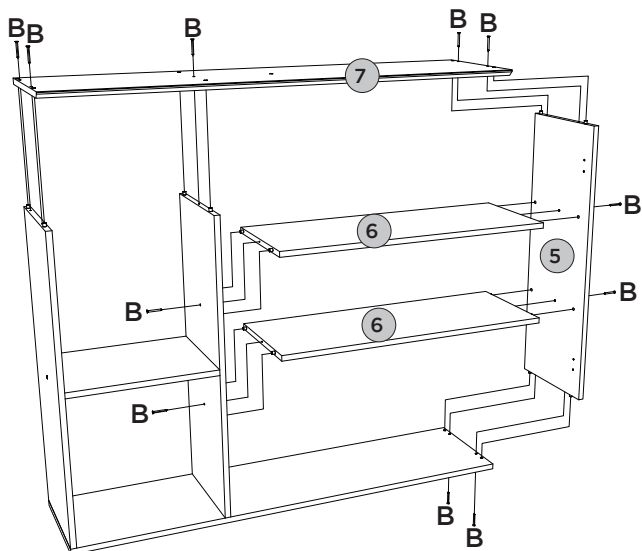
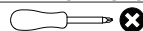



PASSO 4

PEÇAS REQUERIDAS

8	FUNDO LATERAL	x1
9	FUNDO	x3

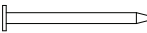
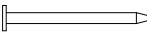
ACESSÓRIOS REQUERIDOS

H			66
I			21

FERRAMENTAS NECESSÁRIAS

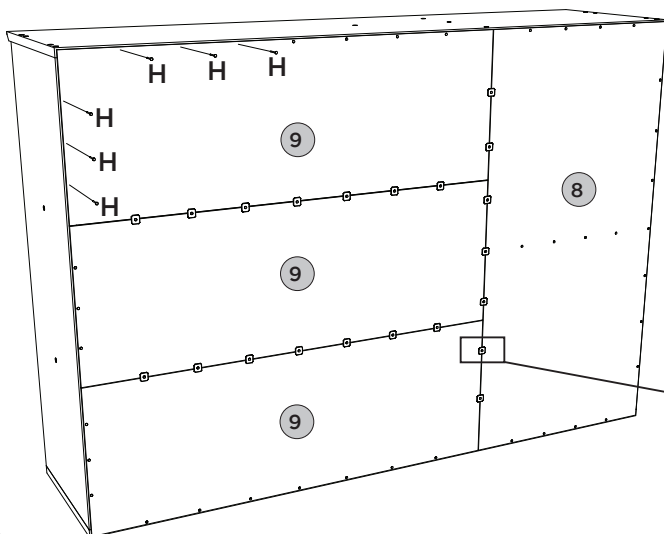
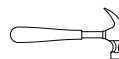

Fixar os pregos a uma distância de 100mm de um para outro.

Fijar las uñas a un distancia de 100 mm uno a otro.

Fix the nails at a distance of 100mm from one to the other

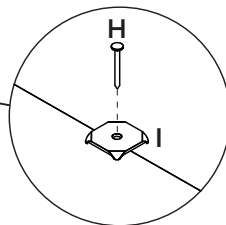



PASSO 5

ITM/C636-

PEÇAS REQUERIDAS

10	PORTA	x3
----	-------	----

ACESSÓRIOS REQUERIDOS

F		12
Q		06

FERRAMENTAS NECESSÁRIAS

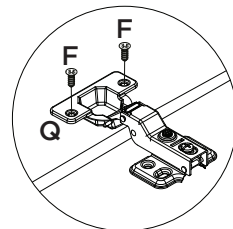
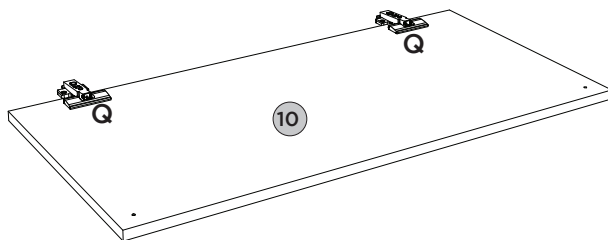
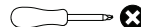



PASSO 6

PEÇAS REQUERIDAS

10	PORTA	x3
----	-------	----

ACESSÓRIOS REQUERIDOS

C		03
F		24
K		03

FERRAMENTAS NECESSÁRIAS



Para portas (10): Defina para o modo de perfuração.

Faça a furação passante para fixar os puxadores (K).

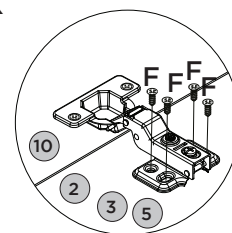
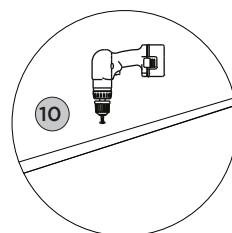
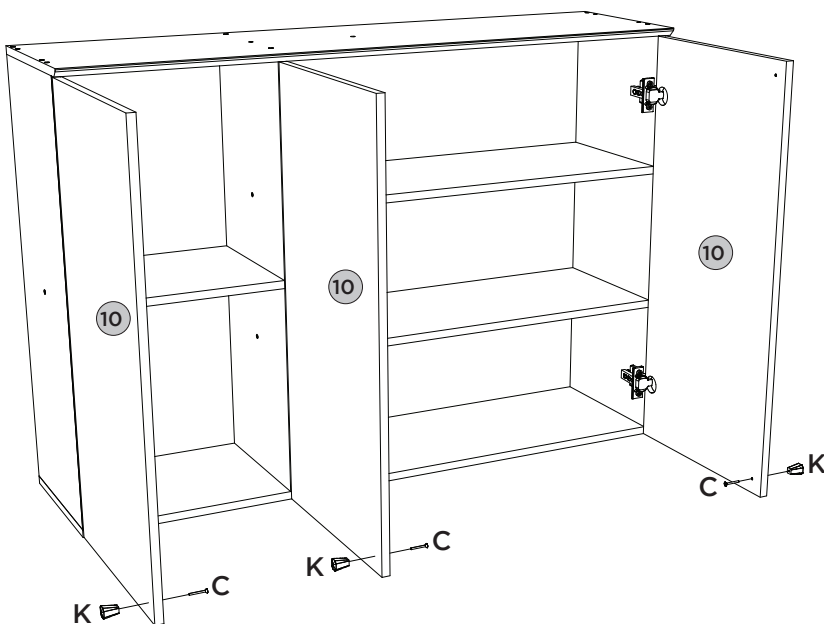

ACESSÓRIOS REQUERIDOS

FERRAMENTAS NECESSÁRIAS

A		03
F		06
J		03
L		03

M		03
N		18
O		02
R	HENN	01

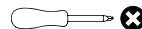

Pesos máximos recomendados com carga distribuída
 Peso máximo recomendado con la carga distribuida
 Recommended maximum weight with distributed load.

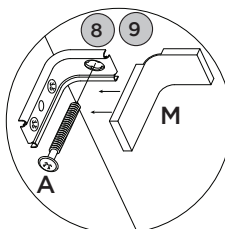
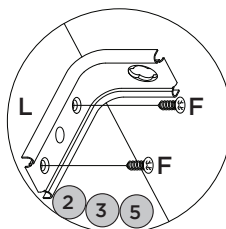
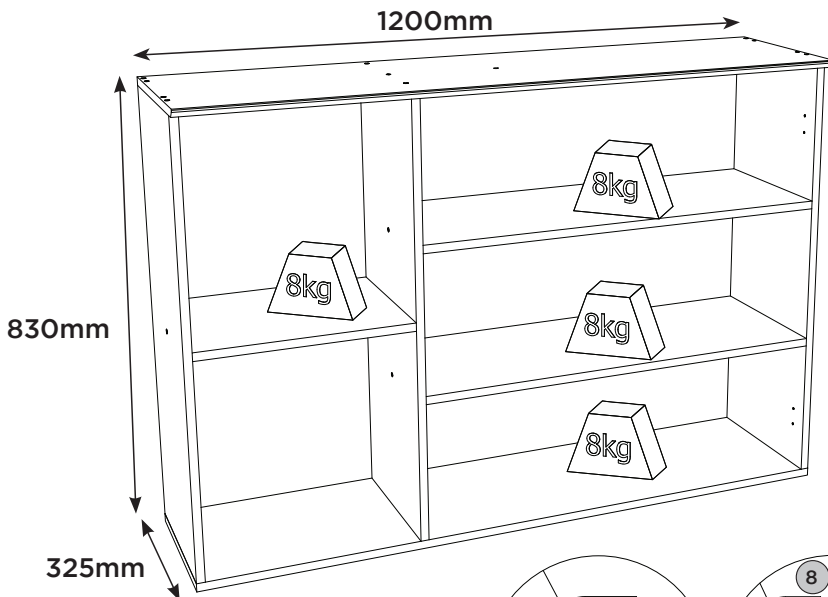

PERFECT CORRECTION
 CORRECCIÓN PERFECTA

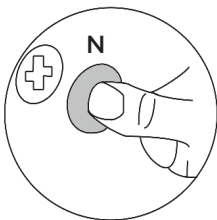
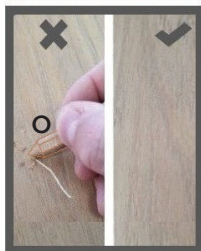

RECOMENDAÇÃO

Para fixar o móvel na parede usar o suporte de fixação (L), o parafuso 4,0x14mm CHT (F), a Bucha 8mm (J) e o parafuso 5,0x50mm FLA (A).

RECOMENDACIÓN

Para conectar el móvil a la pared con el soporte (L), tornillo 4,0x14mm CHT (F), el casquillo de 8mm (J) y el 5,0 x50mm tornillo FLA (A).

RECOMMENDATION

To fix the furniture to the wall use the fixing bracket (L), the 4.0x14mm CHT (F) screw, the 8mm bushing (J) and the 5.0x50mm FLA screw (A).

Producto Concluído
Producto terminado
Finished Product

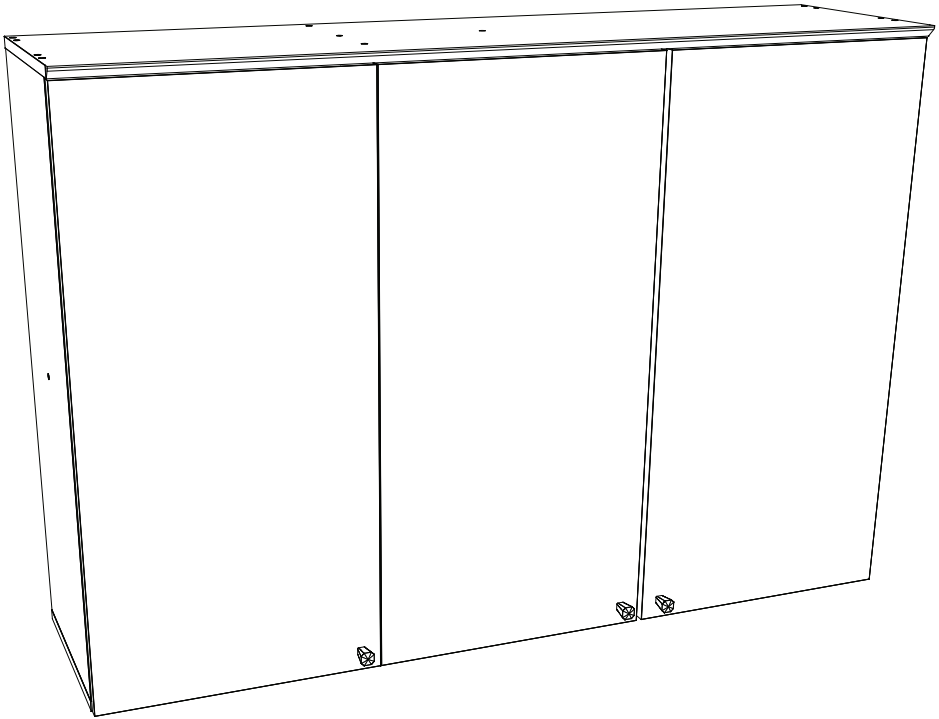

HENNInd. e Com. de Móveis Henn
Mondai - SC - Brasil

☎ +55 49 3674.3500

📧 @moveishenn
www.henn.com.br**INSTRUÇÕES DE
MONTAGEM**INSTRUCCIONES DE MONTAJE
ASSEMBLY INSTRUCTIONS**Aéreo 01 Porta Basculante 800mm Requite | Aéreo 01
Puerta Abatible 800mm Requite |
Aerial 01 Tipper Door 800mm Requite**

C633-128 Nature

C633-217 Nature/Areia HP

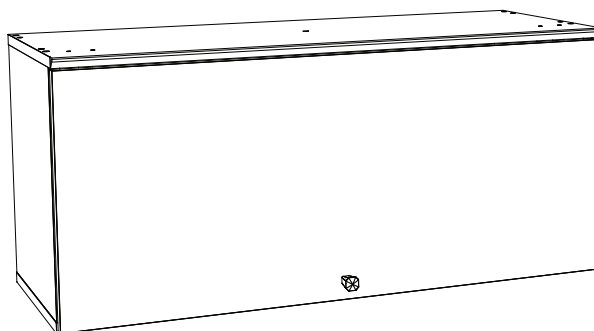
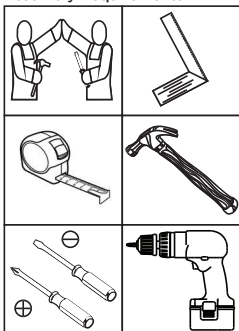
**Requisitos para montagem
Requisitos para la montaje
Assembly Requirements**

Imagens meramente ilustrativas,
não acompanha o produto.
Imágenes ilustrativas, no incluidas
con el producto.
Illustrative images, not included
with the product.

AVISO

Para limpeza de seu móvel, use uma flanela seca ou umedecida, e não utilize produtos químicos que possam danificar seu produto.

SISTEMA DE MONTAGEM

O sistema de montagem dos produtos, funciona de acordo com a ordem crescente dos números indicados no desenho. Ex: 01, 02, 03, 04... até a conclusão da montagem.

ASSISTÊNCIA TÉCNICA

Para solicitação de Assistência Técnica você consumidor deverá entrar em contato com o Lojista o qual você realizou a compra deste produto e solicitar a assistência técnica das peças avariadas. A garantia abrange todas as peças, partes e componentes que eventualmente venham apresentar defeito de fabricação no prazo de 03 (três) meses, contando a partir da entrega do produto ao consumidor, mediante nota fiscal de compra. Se houver qualquer alteração na estrutura do produto ou ocorrer defeito por negligência do montador/consumidor em relação a instrução de montagem e manuseio, não será fornecido assistência técnica gratuita.

ADVERTENCIA

Para limpeza de su móvil, use una franela seca o húmeda, y no utilice productos químicos que puedan dañar su producto.

SISTEMA DE MONTAJE

El sistema de montaje de los productos funciona de acuerdo con el orden creciente de los números indicados en el dibujo. Ej.: 01, 02, 03, 04... hasta la conclusión del montaje.

ASISTENCIA TÉCNICA

Para solicitar Asistencia Técnica, el consumidor debe comunicarse con el Comercio que usted realizó la compra de este producto y solicita asistencia técnica para las partes dañadas. La garantía cubre todas las partes, piezas y componentes que eventualmente puedan presentar defecto de fabricación en el plazo de 03 (tres) meses, contados a partir de la entrega del producto al consumidor, mediante factura de compra. Si se produce algún cambio en la estructura del producto o se produce un defecto por negligencia del montador/consumidor en relación con las instrucciones de montaje y manipulación, no se prestará asistencia técnica gratuita.

NOTICE

To clean your furniture, use a dry or wet cloth, and do not use chemicals that may damage your product.

ASSEMBLY SYSTEM

The products' assembly system works according to the increasing order of the indicated numbers. For example: 01, 02, 03, 04 ... to the end of the assembly.

TECHNICAL ASSISTANCE

To request Technical Assistance, the consumer must contact the retailer from whom you purchased this product and request technical assistance for the damaged parts. The warranty covers all parts, parts and components that may eventually present a manufacturing defect within a period of 03 (three) months, counting from the delivery of the product to the consumer, by means of a purchase invoice. If there is any change in the structure of the product or defect occurs due to negligence of the assembler/consumer in relation to the assembly and handling instruction, free technical assistance will not be provided.

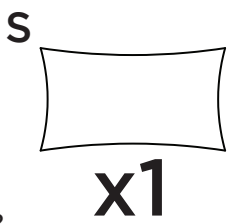
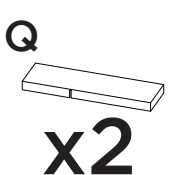
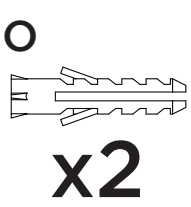
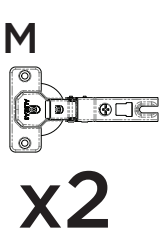
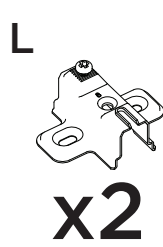
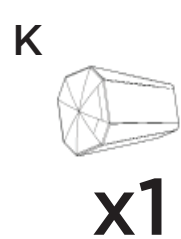
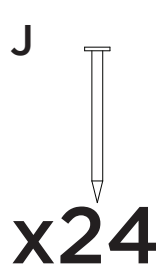
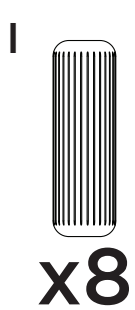
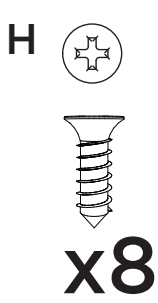
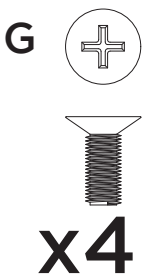
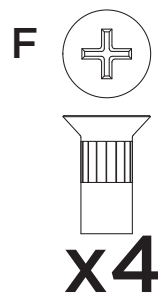
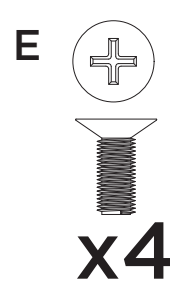
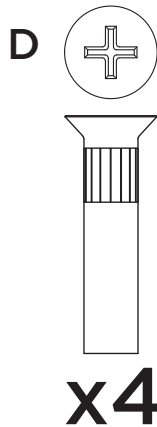
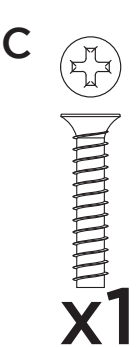
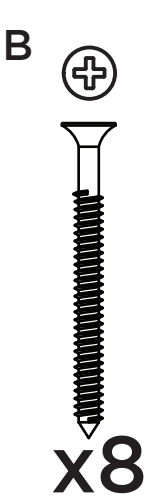
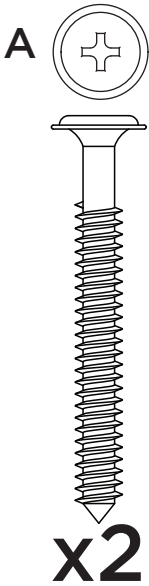

Parafusos em escala
Tornillos escalados
Scaled screws **1:1**

Os parafusos (D/E) devem ser usados somente quando este módulo for acoplado a outro módulo componível Henn.

Los tornillos (D/E) se debe utilizar sólo cuando el módulo está conectado a otro módulo componible Henn.

Screws (D/E) are to be used only when this module is mated to another Henn buildable module.

LISTA DE PEÇAS | LISTA DE PIEZAS | LIST OF PIECES

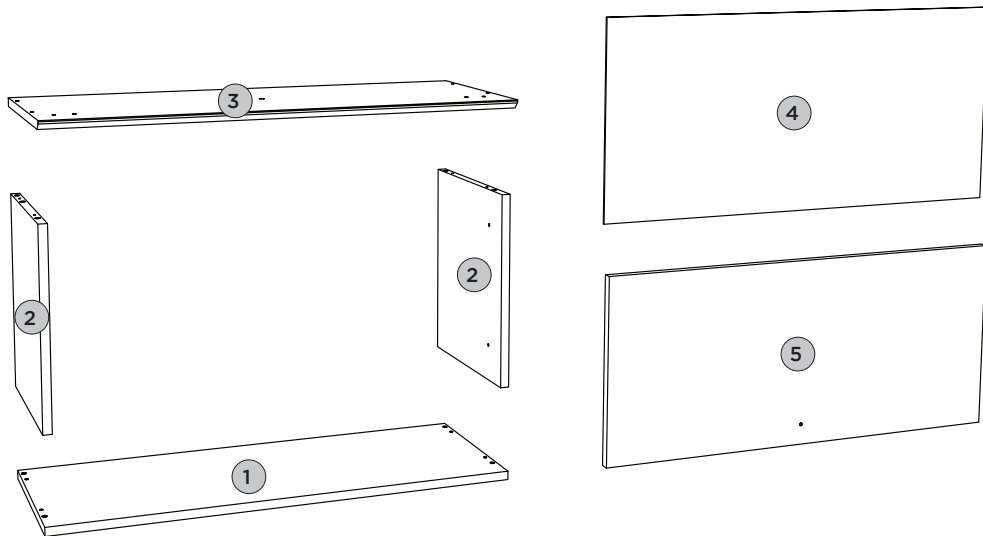





Item	Caixa Caja Box	Qtd Ctd Qty	Descrição Descripción Description	Dimensões (mm) Dimensiones (mm) Dimensions (mm)		
				Comprimento Largo Length	Largura Ancho Width	Espessura Grosor Thickness
1	1/1	01	BASE BASE BASE	800	295	15
2	1/1	02	LATERAL DIREITA ESQUERDA LATERAL DERECHA IZQUIERDA RIGHT LEFT SIDE	337	295	15
3	1/1	01	TAMPO TAPA TOP	800	322	15
4	1/1	01	FUNDO FONDO BACKGROUND	793	361	3
5	1/1	01	PORTA BASCULANTE PUERTA BASCULANTE BASCULATING DOOR	796	345	15

PASSO 1**PEÇAS REQUERIDAS**

2	LATERAL DIREITA ESQUERDA	x2
3	TAMPO	x1

ACESSÓRIOS REQUERIDOS

F		04
G		04
I		08
L		02
S		

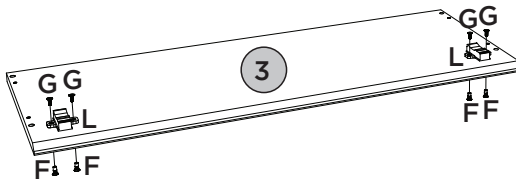
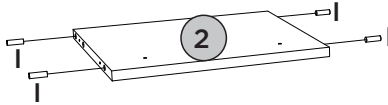
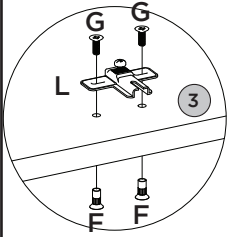
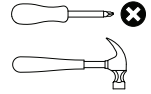
FERRAMENTAS NECESSÁRIAS

Utilizar o sachê de cola (S) em todas as cavilhas (I) do produto.



Con el pegamento sobre (S) en todos los pernos (I) producto.

Use the glue sachet (S) on all the pegs (I) of the product.

PASSO 2**PEÇAS REQUERIDAS**

1	BASE	x1
2	LATERAL DIREITA ESQUERDA	x2
3	TAMPO	x1

ACESSÓRIOS REQUERIDOS

B		08
S		

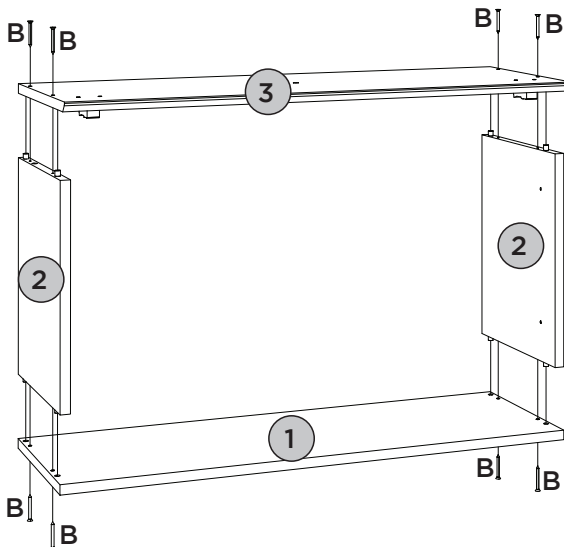
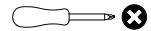
FERRAMENTAS NECESSÁRIAS

PASSO 3

ITM/C633-

PEÇAS REQUERIDAS

4	FUNDO	x1
---	-------	----

ACESSÓRIOS REQUERIDOS

J		24
---	---	----

FERRAMENTAS NECESSÁRIAS

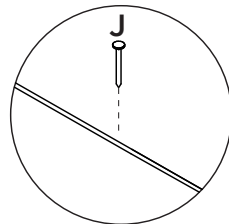
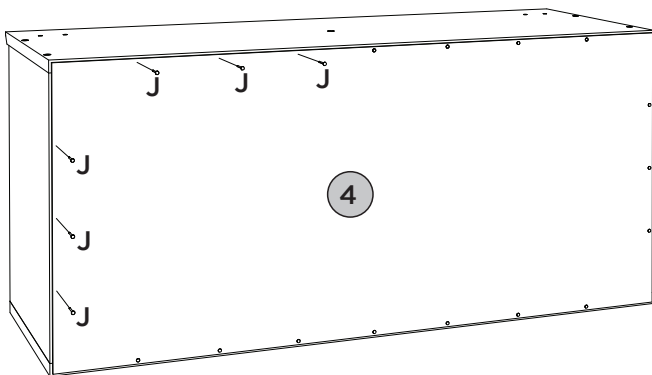
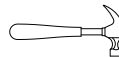

Fixar os pregos a uma distância de 100mm de um para outro.

Fijar las uñas a un distancia de 100mm uno a otro.







Fix the nails at a distance of 100mm from one to the other

PASSO 4

PEÇAS REQUERIDAS

5	PORTA BASCULANTE	x1
---	------------------	----

ACESSÓRIOS REQUERIDOS

C	 	01
H	 	04
K		01
M		02

FERRAMENTAS NECESSÁRIAS

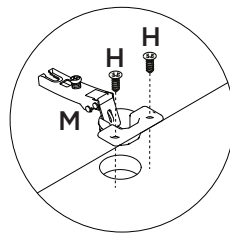
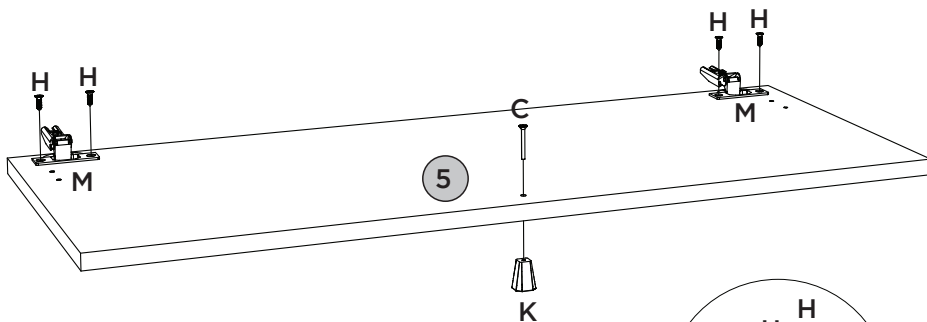
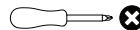

PEÇAS REQUERIDAS

5	PORTA BASCULANTE	x1
---	------------------	----

ACESSÓRIOS REQUERIDOS

N		01
---	--	----

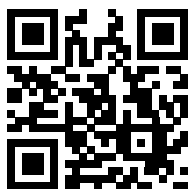
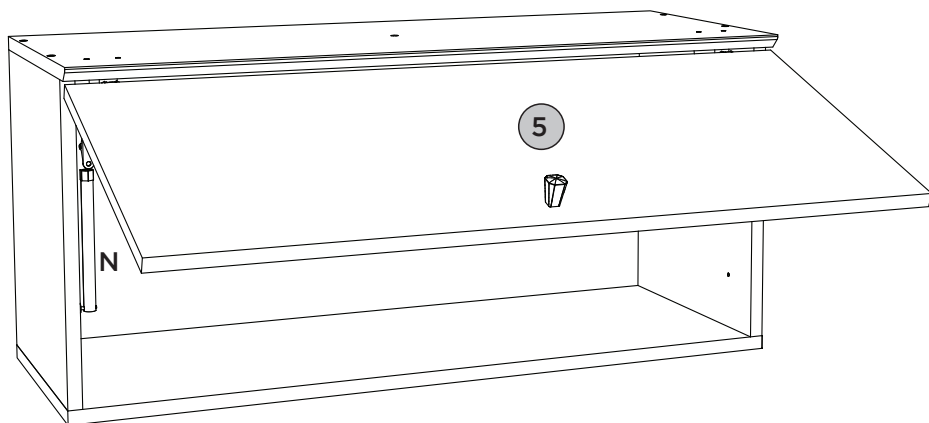
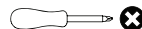
FERRAMENTAS NECESSÁRIAS

Vídeo: Dicas para instalar o
Kit Pistão à Gás

Vídeo: Consejos para instalar el
kit de pistón de gas

Vídeo: Tips for installing
the Gas Piston Kit

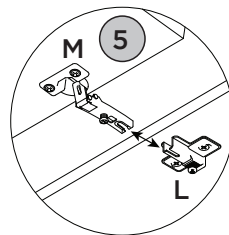
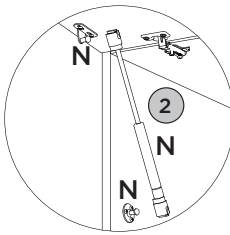
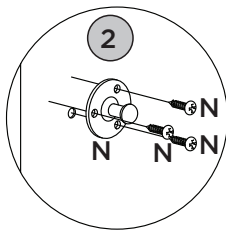
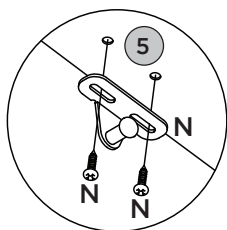

ACESSÓRIOS REQUERIDOS

A		02
H		04
O		02
P		02
Q		02
R		10

FERRAMENTAS NECESSÁRIAS



OU

Para parede: Ajustar no modo perfuração
Para peça (O2): Usar torque 5

Pesos máximos recomendados com carga distribuída
Peso máximo recomendado con la carga distribuida
Recommended maximum weight with distributed load.

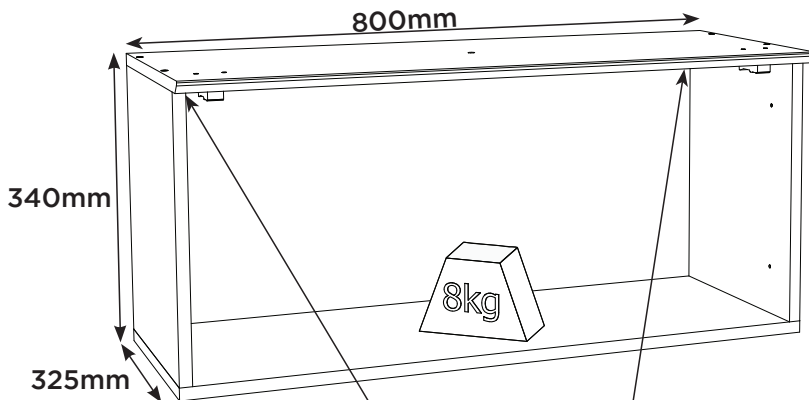

RECOMENDAÇÃO

Para fixar o móvel na parede usar o suporte de fixação (P), o parafuso 4,0x14mm CHT (H), a Bucha 8mm (O) e o parafuso 5,0x50mm FLA (A).

RECOMENDACIÓN

Para conectar el móvil a la pared con el soporte (P), tornillo 4,0 x14mm CHT (H), el casquillo de 8 mm (O) y el 5,0 x50mm tornillo FLA (A).

RECOMMENDATION

To fix the furniture to the wall use the fixing bracket (P), the 4,0x14mm CHT (H) screw, the 8mm bushing (O) and the 5,0x50mm FLA screw (A).

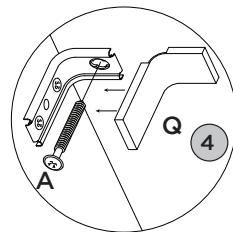
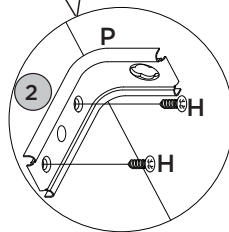
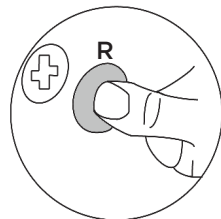

Produto Concluído
Producto terminado
Finished Product

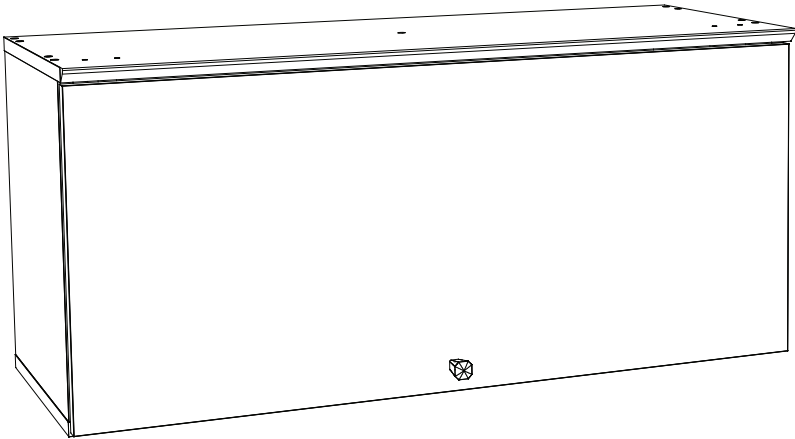

HENNInd. e Com. de Móveis Henn
Mondai - SC - Brasil

☎ +55 49 3674.3500

📧 @moveishenn
www.henn.com.br**INSTRUÇÕES DE
MONTAGEM**INSTRUCCIONES DE MONTAJE
ASSEMBLY INSTRUCTIONS**Balcão Pia 02 Gavetas 03 Portas Requinte |**
Pia Contador 02 Cajones 03 Puertas Requinte |
Balcony Pia 02 Drawers 03 Doors Requinte

C640-217 Nature/Areia

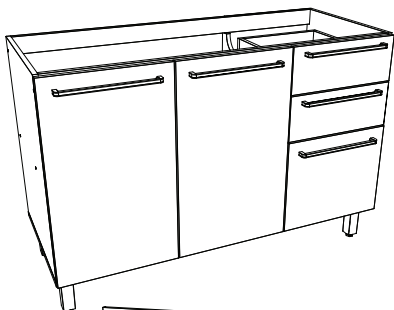
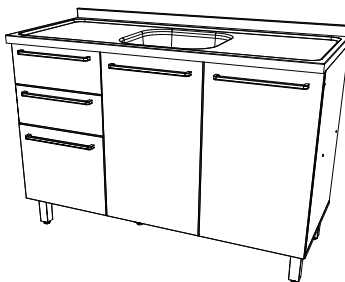
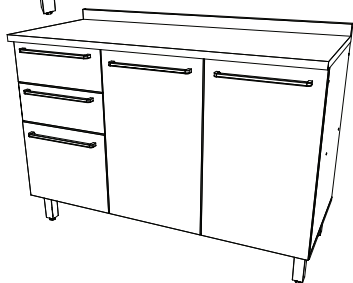
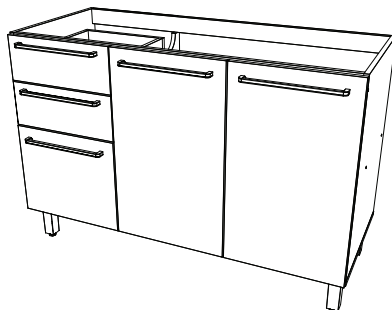
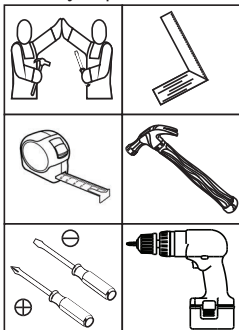
Opção 01
Opción 01
Option 01Opção 02
Opción 02
Option 02Requisitos para montagem
Requisitos para la montaje
Assembly RequirementsImagens meramente ilustrativas,
não acompanha o produto.
Imágenes ilustrativas, no incluidas
con el producto.
Illustrative images, not included
with the product.**AVISO**

Para limpeza de seu móvel, use uma flanela seca ou umedecida, e não utilize produtos químicos que possam danificar seu produto.

SISTEMA DE MONTAGEM

O sistema de montagem dos produtos, funciona de acordo com a ordem crescente dos números indicados no desenho. Ex: 01, 02, 03, 04... até a conclusão da montagem.

ASSISTÊNCIA TÉCNICA

Para solicitação de Assistência Técnica você consumidor deverá entrar em contato com o Lojista a qual você realizou a compra deste produto e solicitar a assistência técnica das peças avariadas. A garantia abrange todas as peças, partes e componentes que eventualmente venham apresentar defeito de fabricação no prazo de 03 (três) meses, contando a partir da entrega do produto ao consumidor, mediante nota fiscal de compra. Se houver qualquer alteração na estrutura do produto ou ocorrer defeito por negligência do montador/consumidor em relação a instrução de montagem e manuseio, não será fornecido assistência técnica gratuita.

ADVERTENCIA

Para limpieza de su móvil, use una flanela seca o húmeda, y no utilice productos químicos que puedan dañar su producto.

SISTEMA DE MONTAJE

El sistema de montaje de los productos funciona de acuerdo con el orden creciente de los números indicados en el dibujo. Ej.: 01, 02, 03, 04... hasta la conclusión del montaje.

ASSISTENCIA TÉCNICA

Para solicitar Asistencia Técnica, el consumidor debe comunicarse con el Comercio que usted realizó la compra de este producto y solicita asistencia técnica para las partes dañadas. La garantía cubre todas las partes, piezas y componentes que eventualmente puedan presentar defecto de fabricación en el plazo de 03 (tres) meses, contados a partir de la entrega del producto al consumidor, mediante factura de compra. Si se produce algún cambio en la estructura del producto o se produce un defecto por negligencia del montador/consumidor en relación con las instrucciones de montaje y manipulación, no se prestará asistencia técnica gratuita.

NOTICE

To clean your furniture, use a dry or wet cloth, and do not use chemicals that may damage your product.

ASSEMBLY SYSTEM

The products' assembly system works according to the increasing order of the indicated numbers. For example: 01, 02, 03, 04 ... to the end of the assembly.

TECHNICAL ASSISTANCE

To request Technical Assistance, the consumer must contact the retailer from whom you purchased this product and request technical assistance for the damaged parts. The warranty covers all parts, parts and components that may eventually present a manufacturing defect within a period of 03 (three) months, counting from the delivery of the product to the consumer, by means of a purchase invoice. If there is any change in the structure of the product or defect occurs due to negligence of the assembler/consumer in relation to the assembly and handling instruction, free technical assistance will not be provided.

ACESSÓRIOS | ACCESORIOS | ACCESSORIES



x5

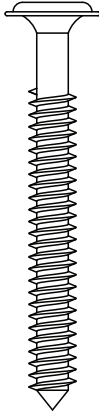

x2



x4



x2



x14

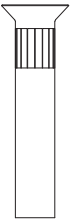

x6

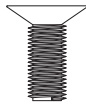

x6

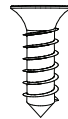

x98



x4



x10

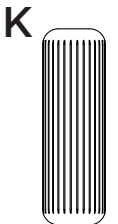

x32



x38



x13



Os parafusos (F/G) devem ser usados somente quando este módulo for acoplado a outro módulo componível Henn.



Los tornillos (F/G) se debe utilizar sólo cuando el módulo está conectado a otro módulo componible Henn.



Screws (F/G) are to be used only when this module is mated to another Henn buildable module.

Parafusos em escala
Tornillos escalados
Scaled screws **1:1**

ACESSÓRIOS | ACCESORIOS | ACCESSORIES

N

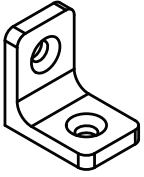

x11

O

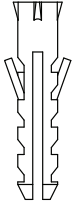

x2

P

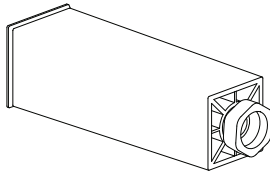

x5

Q

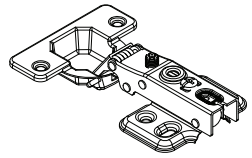

x6

R

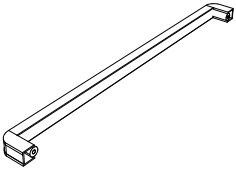

x5

S

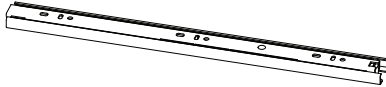

x2

T

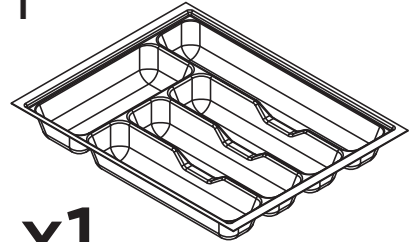

x1

U

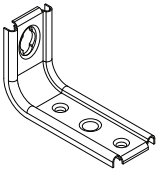

x2

V

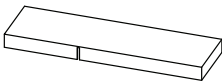

x2

W

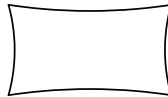

x2

X

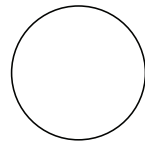

x6

Y



x26

Z

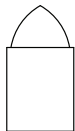

x3

AA



x1

LISTA DE PEÇAS | LISTA DE PIEZAS | LIST OF PIECES

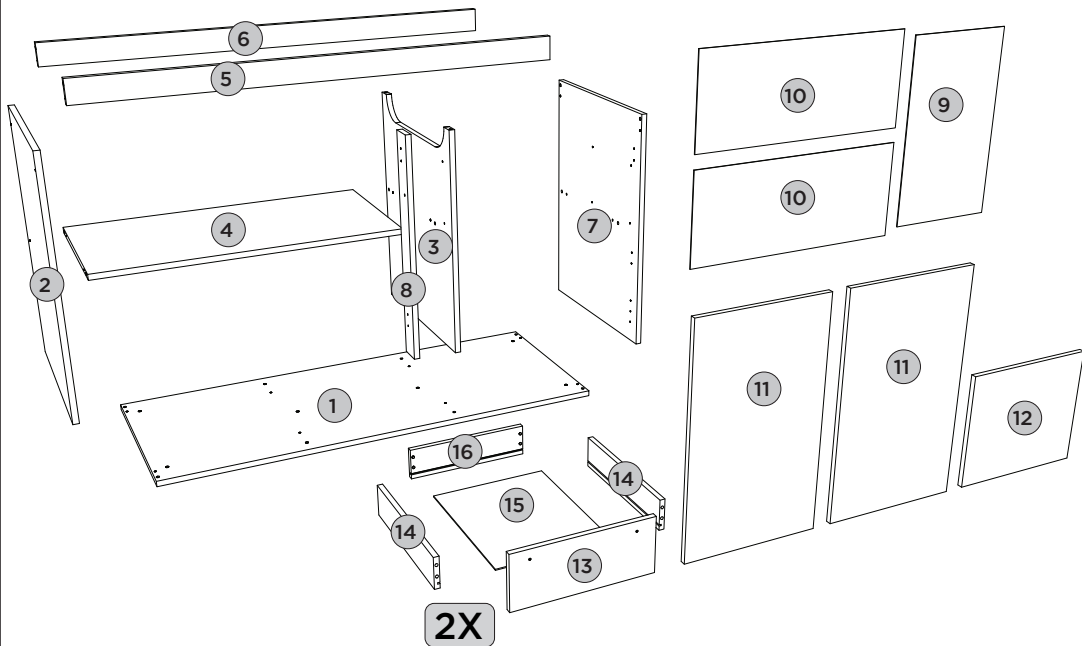

Item	Caixa Caja Box	Qty Ctd Qty	Descrição Descripción Description	Dimensões (mm) Dimensiones (mm)		
				Comprimento Largo Length	Largura Ancho Width	Espessura Grosor Thickness
1	1/1	01	BASE BASE BASE	1200	490	15
2	1/1	01	LATERAL ESQUERDA LATERAL IZQUIERDA LEFT SIDE	660	490	15
3	1/1	01	DIVISÃO DIVISIÓN DIVISION	600	490	15
4	1/1	01	PRATELEIRA ESTANTE SHELF	783	400	15
5	1/1	01	TRAVESSA FRONTAL TRAVESAÑO FRONTAL FRONT CROSSBAR	1168	60	15
6	1/1	01	TRAVESSA TRASEIRA TRAVESAÑO TRASERO REAR BUMPER	1168	60	15
7	1/1	01	LATERAL DIREITA LATERAL DERECHA RIGHT SIDE	660	490	15
8	1/1	01	PILASTRA DA PORTA PILASTRA PUERTA PILASTER DOOR	597	60	15
9	1/1	01	FUNDO MENOR FONDO MENOR MINOR FUND	672	389	3
10	1/1	02	FUNDO FONDO BOTTOM	802	335	3
11	1/1	02	PORTA PUERTA DOOR	665	396	15
12	1/1	01	PORTA MENOR PUERTA MENOR SMALLER DOOR	396	337	15
13	1/1	02	FRENTE DE GAVETA FRENTE DE CAJÓN FRONT OF DRAWER	396	160	15
14	1/1	04	LADO DE GAVETA MENOR LADO DEL CAJÓN MENOR SMALLEST DRAWER SIDE	400	90	15
15	1/1	02	FUNDO DE GAVETA FONDO DE CAJÓN BOTTOM OF DRAWER	411	326	3
16	1/1	02	RIPA DE TRÁS MALLA DETRÁS REAR LATH	345	90	15





PASSO 1

ITM/C640-

PEÇAS REQUERIDAS

1	BASE	x1
4	PRATELEIRA	x1
5	TRAVESSA FRONTAL	x1
6	TRAVESSA TRASEIRA	x1

ACESSÓRIOS REQUERIDOS

A		05
K		08
P		05
W		

FERRAMENTAS NECESSÁRIAS

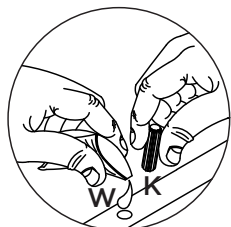
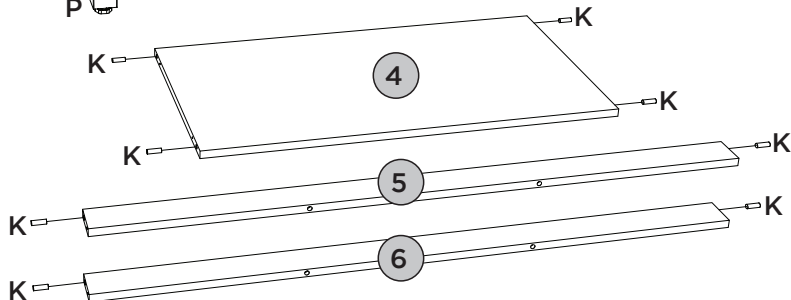
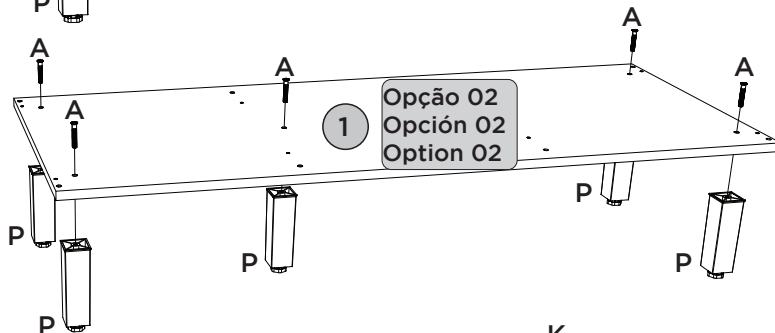
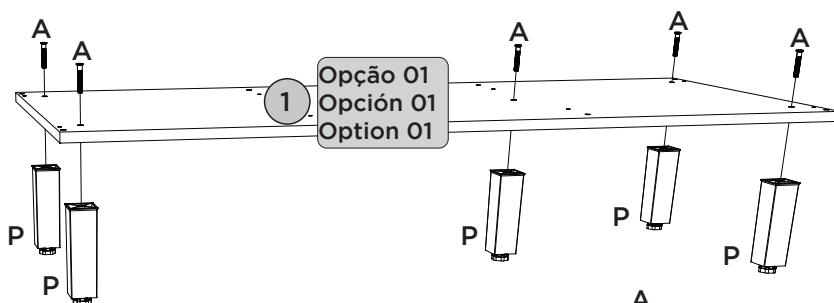
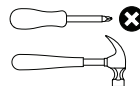

Utilizar o sachê de cola (W) em todas as cavilhas (K) do produto.

Con el pegamento sobre (W) en todos los pernos (K) producto.

Use the glue sachet (W) on all the pegs (K) of the product.

PASSO 2

ITM/C640-

PEÇAS REQUERIDAS

2	LATERAL ESQUERDA	x1
3	DIVISÃO	x1
7	LATERAL DIREITA	x1

ACESSÓRIOS REQUERIDOS

H		12
K		08
S		04
W		

FERRAMENTAS NECESSÁRIAS

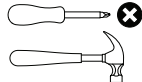

Fixar as correijas nessas furações
Fijar las diapositivas de estos agujeros
Fix the slides in these holes

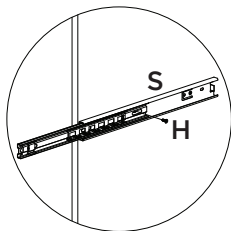
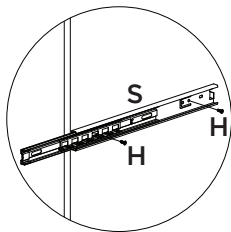
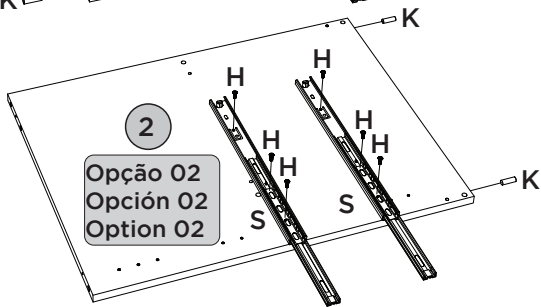
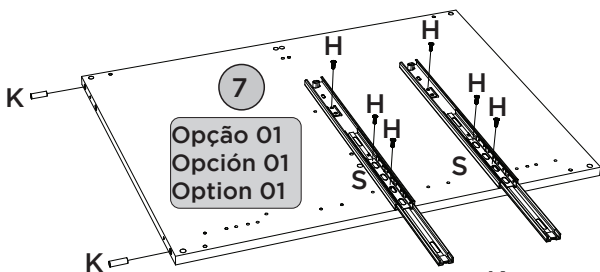
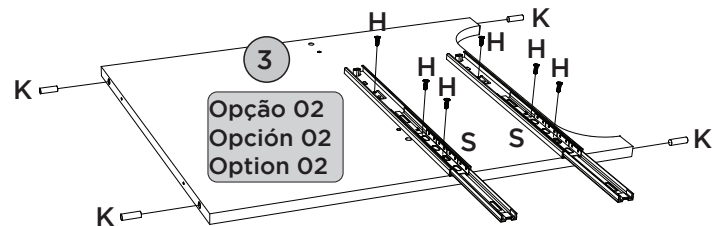
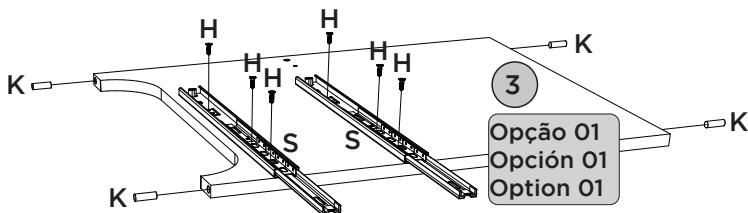
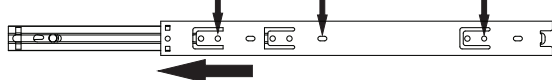

Na Opção 01 a Lateral Esquerda (02) ficará apenas com cavilhas (K), assim como na opção 02 a Lateral Direita (07) ficará apenas com cavilhas (K).

En la Opción 01 el Lado Izquierdo (02) solo tendrá pasadores (K), al igual que en la opción 02 el Lado Derecho (07) solo tendrá pasadores (K).

In Option 01 the Left Side (02) will only have pins (K), just as in option 02 the Right Side (07) will only have pins (K).



PASSO 3

ITM/C640-

PEÇAS REQUERIDAS

1	BASE	x1
2	LATERAL ESQUERDA	x1
3	DIVISÃO	x1
4	PRATELEIRA	x1
5	TRAVESSA FRONTAL	x1
6	TRAVESSA TRASEIRA	x1
7	LATERAL DIREITA	x1

ACESSÓRIOS REQUERIDOS

E		10
W		

FERRAMENTAS NECESSÁRIAS

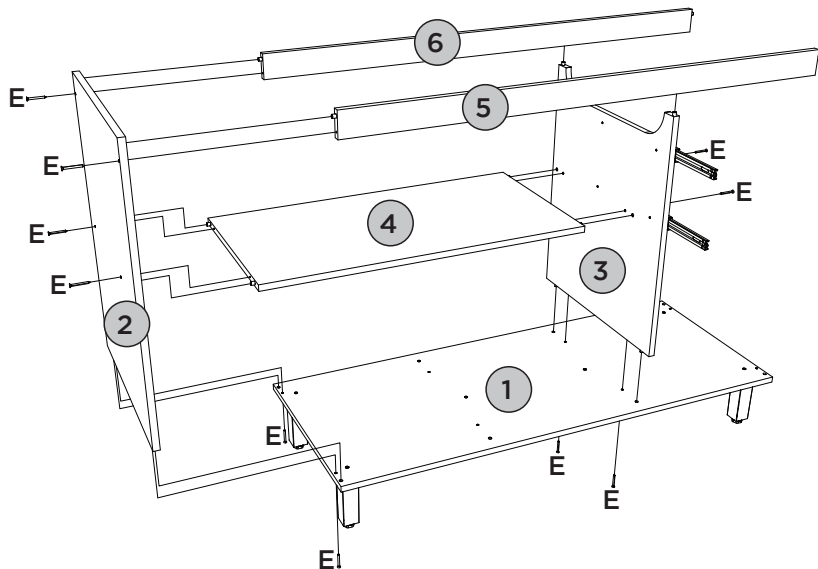
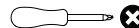

Opção 01
Opción 01
Option 01



Opção 02
Opción 02
Option 02

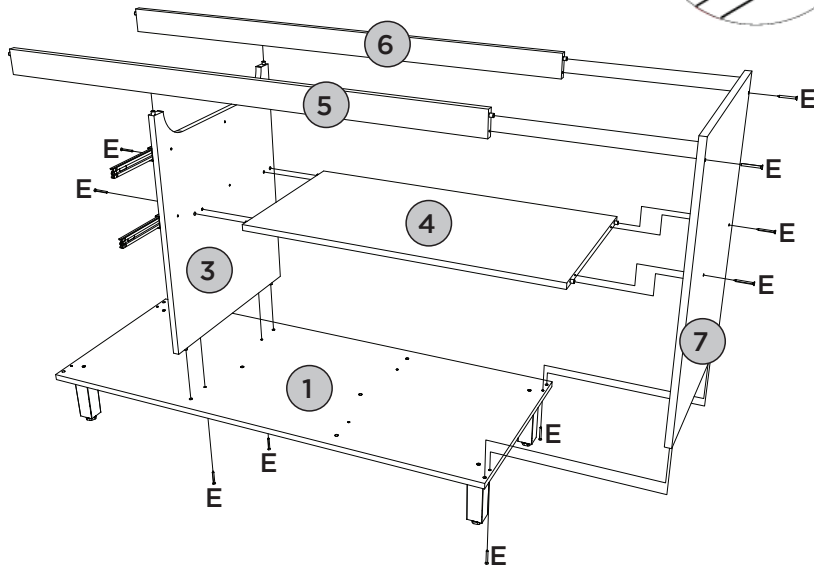





PASSO 4

ITM/C640-

PEÇAS REQUERIDAS

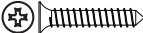
2	LATERAL ESQUERDA	x1
7	LATERAL DIREITA	x1
8	PILASTRA DA PORTA	x1

ACESSÓRIOS REQUERIDOS

D		02
E		04
H		02
N		01
W		

FERRAMENTAS NECESSÁRIAS



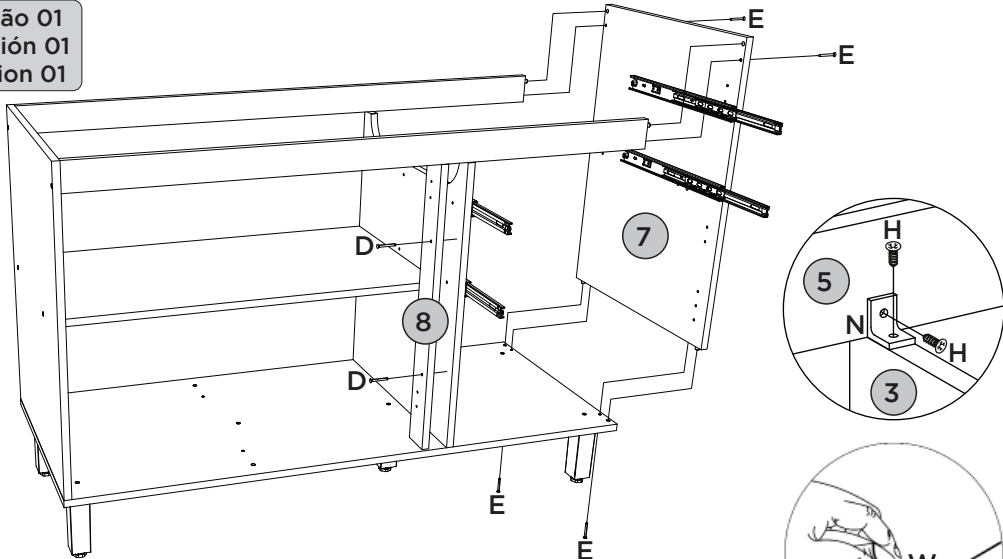

Opção 01
Opción 01
Option 01

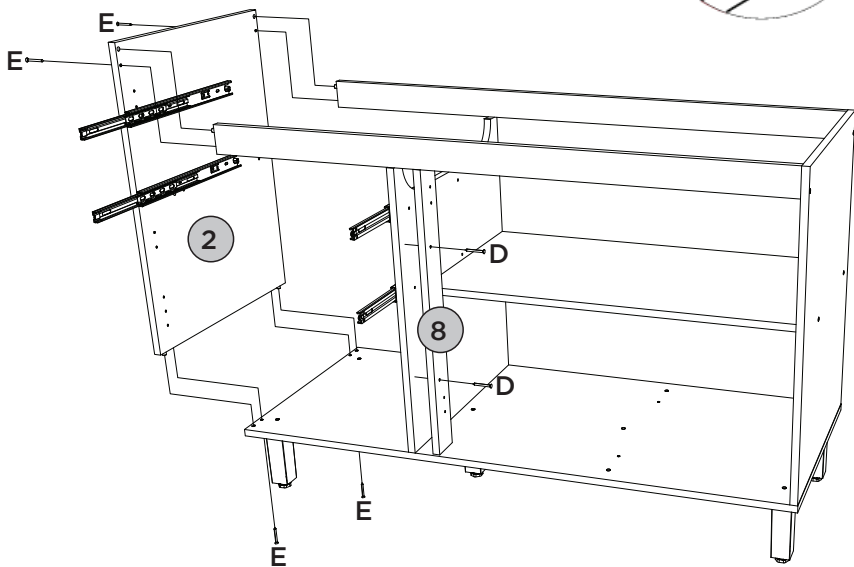

Opção 02
Opción 02
Option 02



ACESSÓRIOS REQUERIDOS

C		04
H		12
N		06

FERRAMENTAS NECESSÁRIAS



Esse tampo é opcional e é vendido separadamente (C905-128).

Esta vez es opcional y se vende por separado (C905-128).

This top is optional and is sold separately (C905-128).

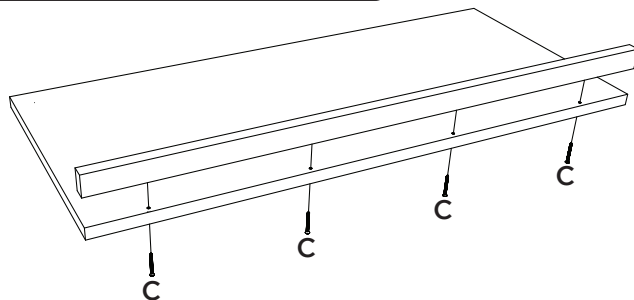

Opção 01
Opción 01
Option 01

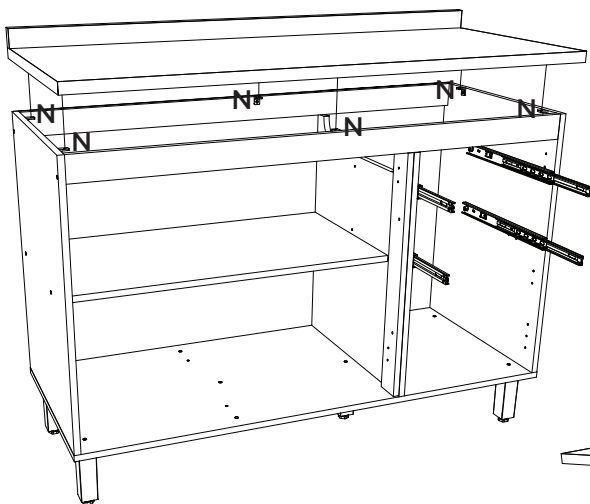

Opção 02
Opción 02
Option 02

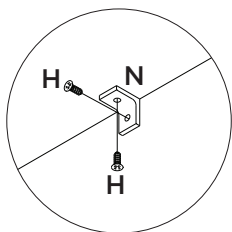
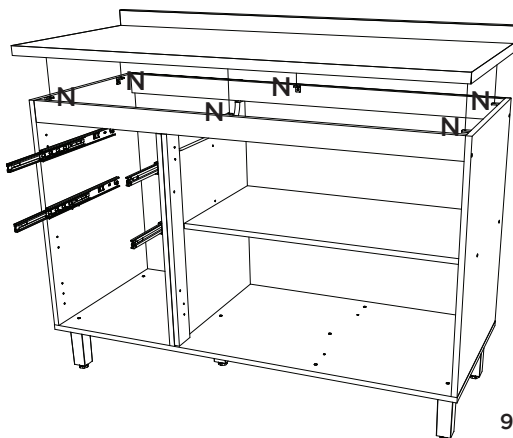



PASSO 6

ITM/C640-

PEÇAS REQUERIDAS

9	FUNDO MENOR	x1
10	FUNDO	x2

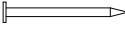
ACESSÓRIOS REQUERIDOS

H		12
L		38
M		13

FERRAMENTAS NECESSÁRIAS

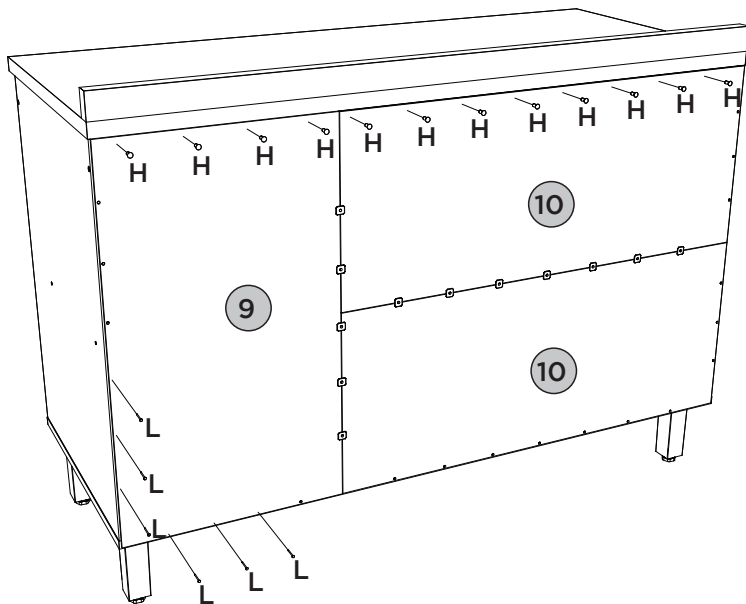
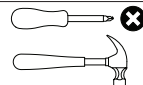

Opção 01
Opción 01
Option 01

Opção 02
Opción 02
Option 02

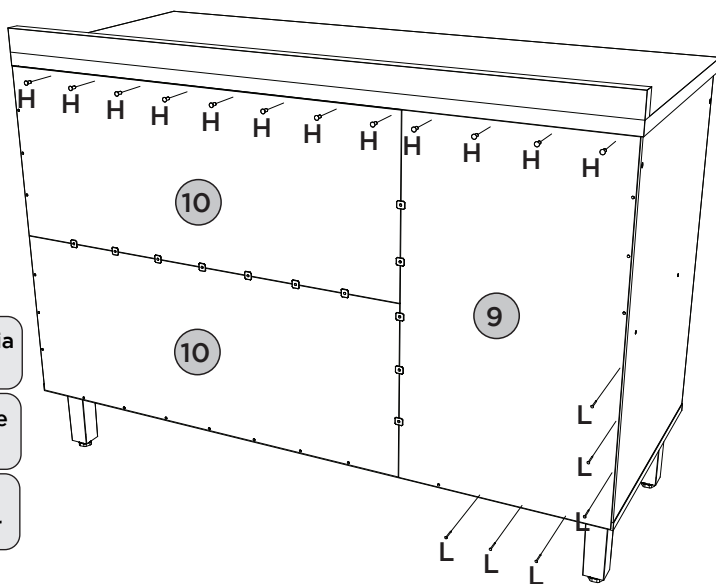

Fixar os pregos a uma distância de 100mm de um para outro.



Fijar las uñas a un distancia de 100mm uno a otro.

Fix the nails at a distance of 100mm from one to the other

PEÇAS REQUERIDAS

11	PORTA	x2
12	PORTA MENOR	x1

ACESSÓRIOS REQUERIDOS

H		12
Q		06

FERRAMENTAS NECESSÁRIAS

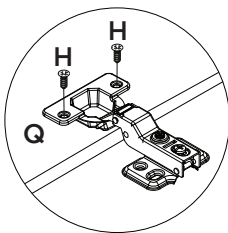
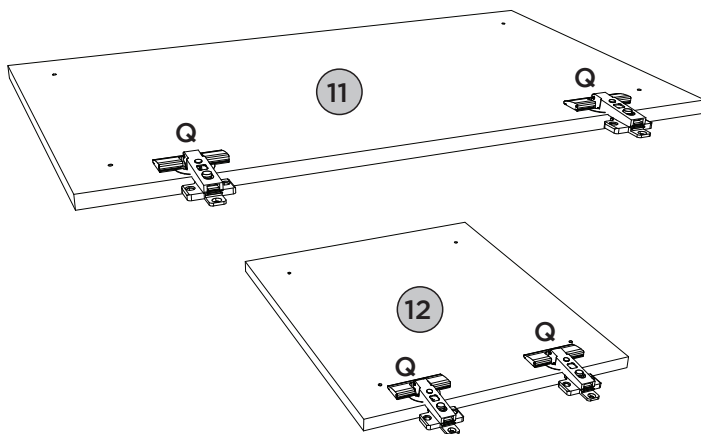
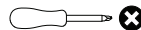



PASSO 8

ITM/C640-

PEÇAS REQUERIDAS

11	PORTA	x2
12	PORTA MENOR	x1

ACESSÓRIOS REQUERIDOS

H		24
J		06
R		03

FERRAMENTAS NECESSÁRIAS



Para porta (11 e 12): Defina para o modo de perfuração.
Faça a furação passante para fixar os puxadores (R).

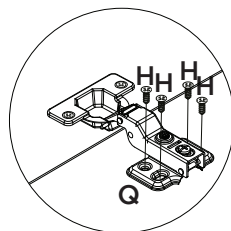
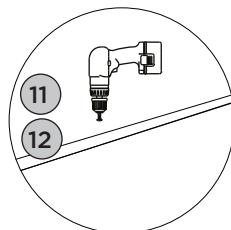
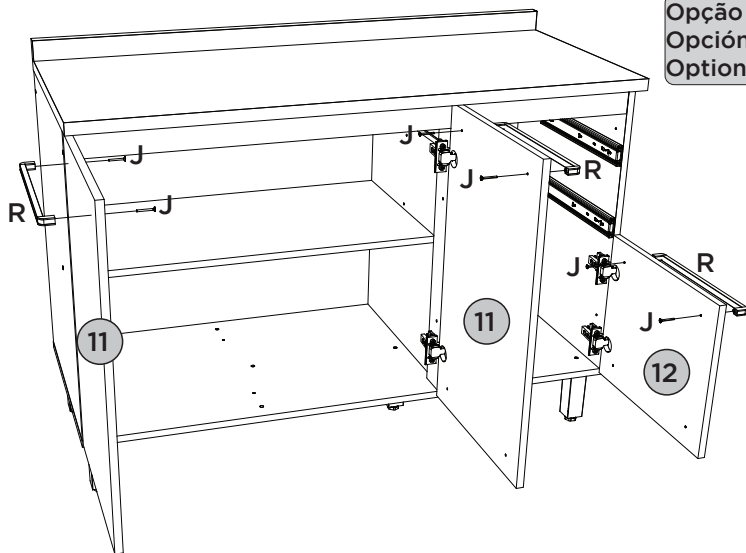

Opção 02
Opción 02
Option 02

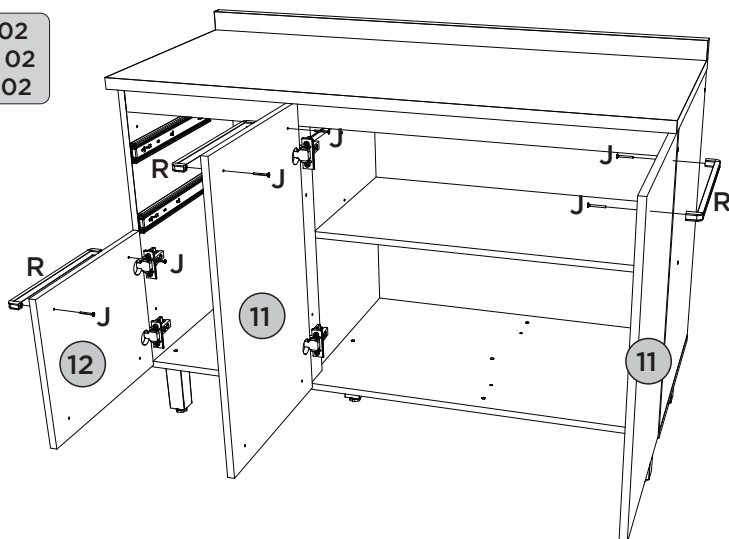





PASSO 9

ITM/C640-

PEÇAS REQUERIDAS

13	FRENTE DE GAVETA	x2
14	LADO DE GAVETA	x4
15	FUNDO DE GAVETA	x2

ACESSÓRIOS REQUERIDOS

H		08
K		16
N		04
W		

FERRAMENTAS NECESSÁRIAS

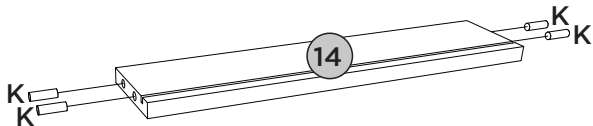
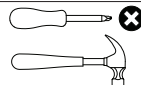

1º
2X

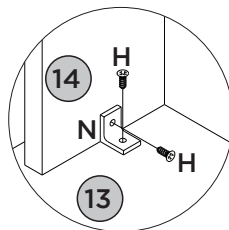
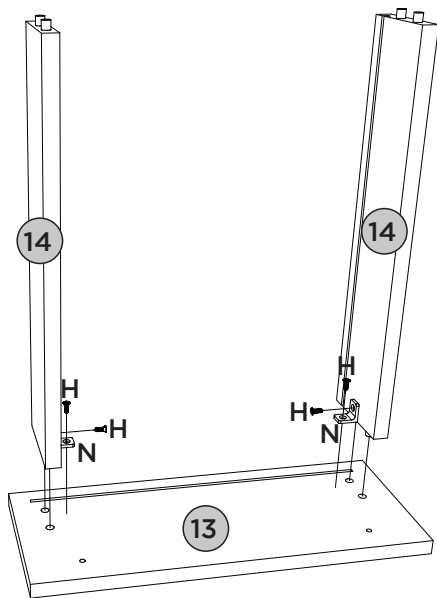

2º
2X

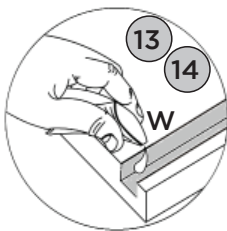
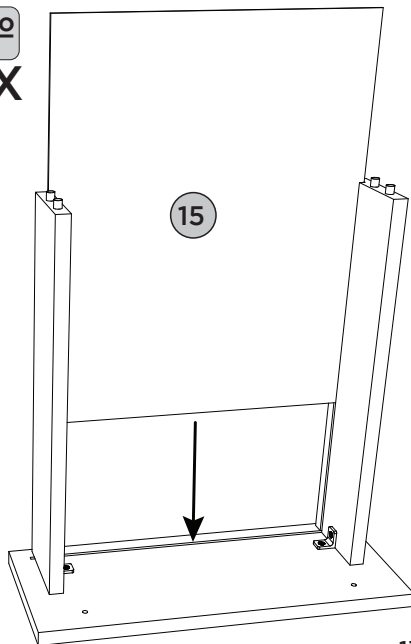

PASSO 10

ITM/C640-

PEÇAS REQUERIDAS

16	RIPA DE TRÁS	x2
----	--------------	----

ACESSÓRIOS REQUERIDOS

H		12
I		04
J		04
R		02
S		04
W		

FERRAMENTAS NECESSÁRIAS

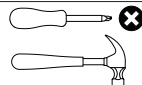

3º
2X

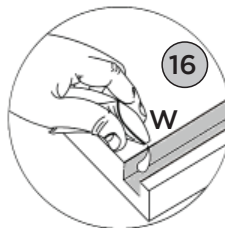
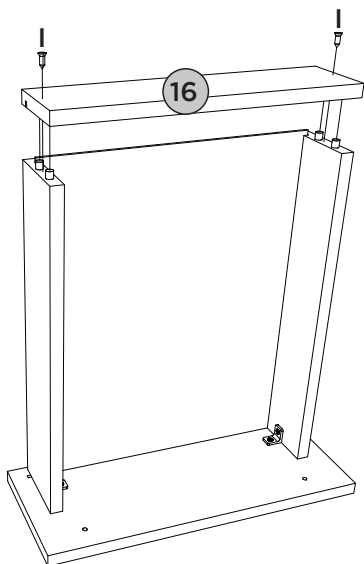

4º
2X

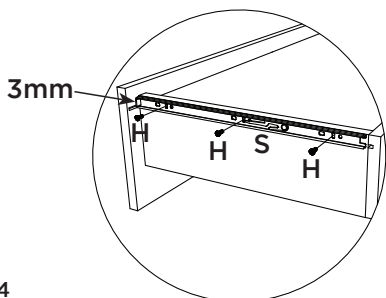
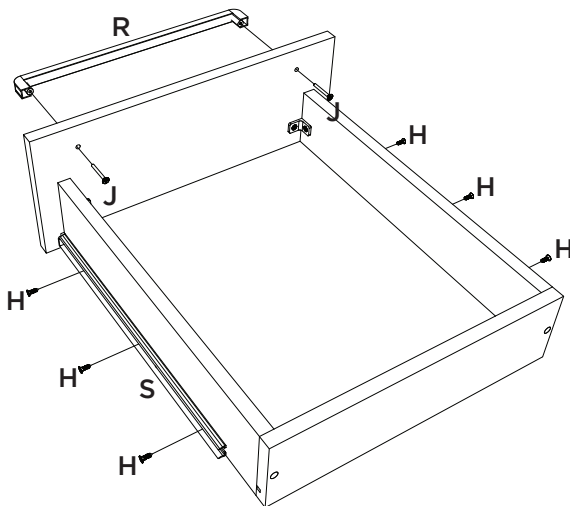

ACESSÓRIOS REQUERIDOS

B		02	X		06
H		04	Y		26
O		02	Z		03
U		02	AA		01
V		02			

FERRAMENTAS NECESSÁRIAS



OU

Para parede: Ajustar no modo perfuração.
Para peça (02 e 07): Usar torque 5.

Pesos máximos recomendados com carga distribuída
Peso máximo recomendado con la carga distribuida
Recommended maximum weight with distributed load.

PERFECT CORRECTION
CORRECCIÓN PERFECTA

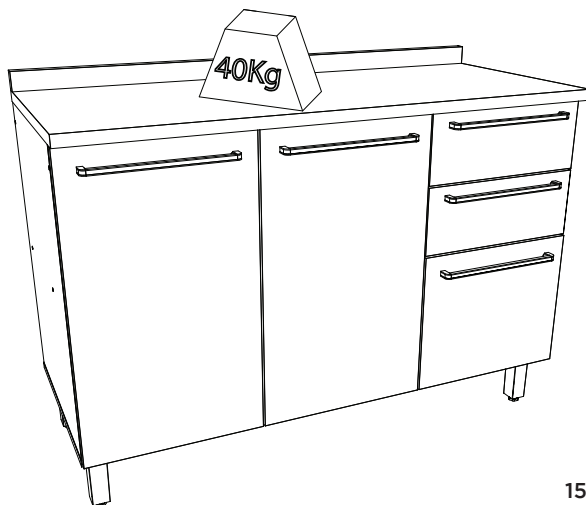
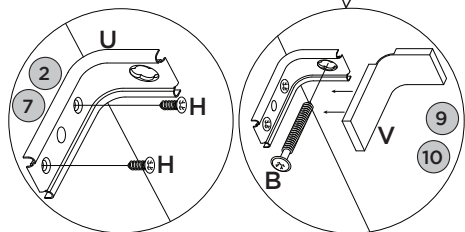
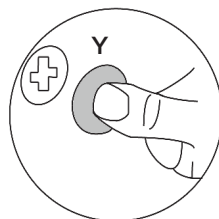
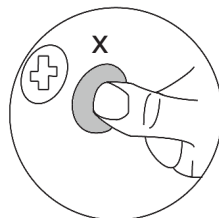
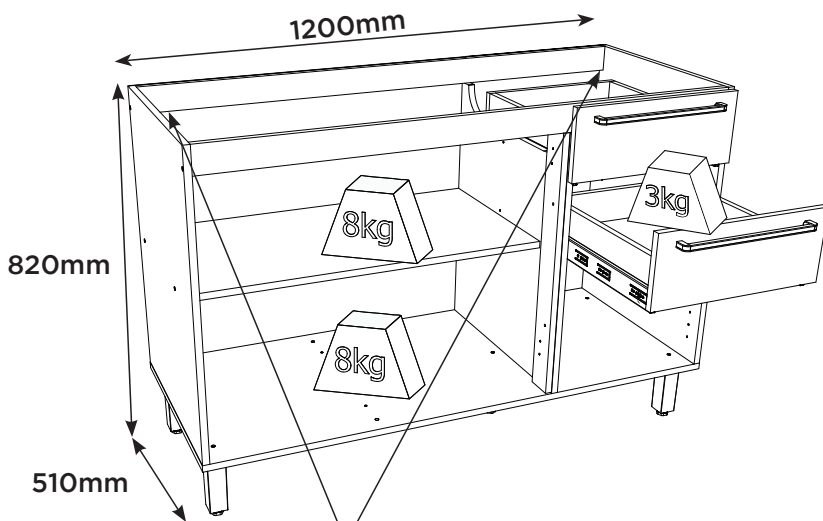
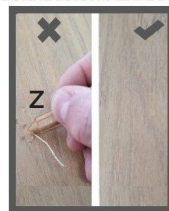

RECOMENDAÇÃO

Para fixar o móvel na parede usar o suporte de fixação (U), o parafuso 4,0x14mm CHT (H), a Bucha 8mm (O) e o parafuso 5,0x50mm FLA (B).

RECOMENDACIÓN

Para conectar el móvil a la pared con el soporte (U), tornillo 4,0 x14mm CHT (H), el casquillo de 8 mm (O) y el 5,0 x50mm tornillo FLA (B).

RECOMMENDATION

To fix the furniture to the wall use the fixing bracket (U), the 4,0x14mm CHT (H) screw, the 8mm bushing (O) and the 5.0x50mm FLA screw (B).

Producto Concluído
Producto terminado
Finished Product

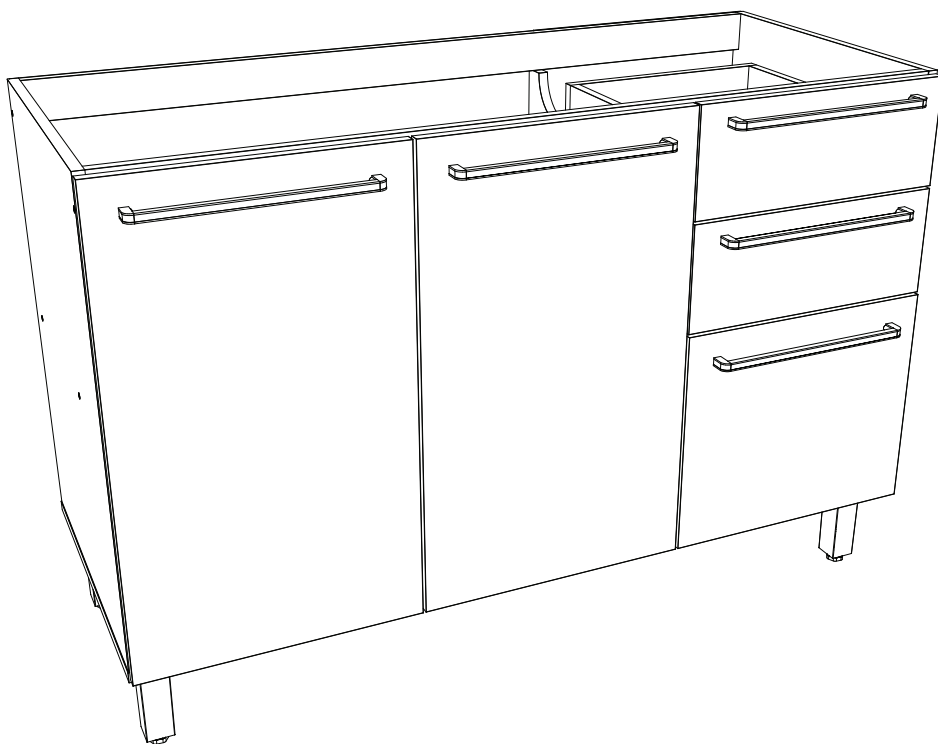

HENNInd. e Com. de Móveis Henn
Mondai - SC - Brasil

☎ +55 49 3674.3500

📧 @moveishenn
www.henn.com.br**INSTRUÇÕES DE
MONTAGEM**INSTRUCCIONES DE MONTAJE
ASSEMBLY INSTRUCTIONS**Balcão 02 Portas 800mm Requite |**

Contador 02 Puertas 800mm Requite | Counter 02 Doors 800mm Requite

C639-217 Nature/Areia HP

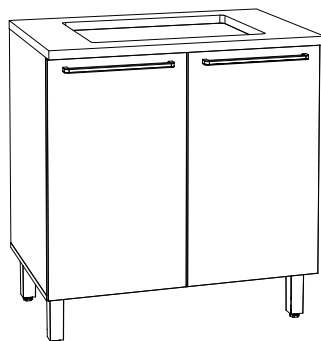
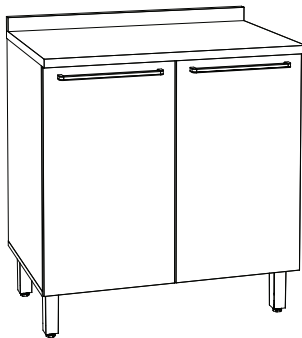
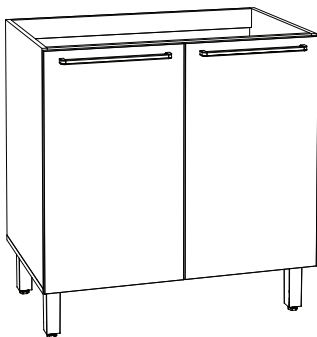
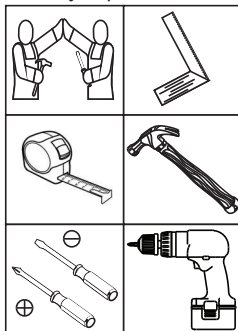
Opção 01
Opción 01
Option 01Opção 02
Opción 02
Option 02**Requisitos para montagem
Requisitos para la montaje
Assembly Requirements**

Imagens meramente ilustrativas,
não acompanha o produto.
Imágenes ilustrativas, no incluidas
con el producto.
Illustrative images, not included
with the product.

AVISO

Para limpeza de seu móvel, use uma franela seca ou umedecida, e não utilize produtos químicos que possam danificar seu produto.

SISTEMA DE MONTAGEM

O sistema de montagem dos produtos, funciona de acordo com a ordem crescente dos números indicados no desenho. Ex: 01, 02, 03, 04... até a conclusão da montagem.

ASSISTÊNCIA TÉCNICA

Para solicitação de Assistência Técnica você consumidor deverá entrar em contato com o Lojista a qual você realizou a compra deste produto e solicitar a assistência técnica das peças avariadas. A garantia abrange todas as peças, partes e componentes que eventualmente venham apresentar defeito de fabricação no prazo de 03 (três) meses, contando a partir da entrega do produto ao consumidor, mediante nota fiscal de compra. Se houver qualquer alteração na estrutura do produto ou ocorrer defeito por negligência do montador/consumidor em relação a instrução de montagem e manuseio, não será fornecido assistência técnica gratuita.

ADVERTENCIA

Para limpieza de su móvil, use una franela seca o húmeda, y no utilice productos químicos que puedan dañar su producto.

SISTEMA DE MONTAJE

El sistema de montaje de los productos funciona de acuerdo con el orden creciente de los números indicados en el dibujo. Ej.: 01, 02, 03, 04... hasta la conclusión del montaje.

ASISTENCIA TÉCNICA

Para solicitar Asistencia Técnica, el consumidor debe comunicarse con el Comercio que usted realizó la compra de este producto y solicita asistencia técnica para las partes dañadas. La garantía cubre todas las partes, piezas y componentes que eventualmente puedan presentar defecto de fabricación en el plazo de 03 (tres) meses, contados a partir de la entrega del producto al consumidor, mediante factura de compra. Si se produce algún cambio en la estructura del producto o se produce un defecto por negligencia del montador/consumidor en relación con las instrucciones de montaje y manipulación, no se prestatá asistencia técnica gratuita.

NOTICE

To clean your furniture, use a dry or wet cloth, and do not use chemicals that may damage your product.

ASSEMBLY SYSTEM

The products' assembly system works according to the increasing order of the indicated numbers. For example: 01, 02, 03, 04 ... to the end of the assembly.

TECHNICAL ASSISTANCE

To request Technical Assistance, the consumer must contact the retailer from whom you purchased this product and request technical assistance for the damaged parts. The warranty covers all parts, parts and components that may eventually present a manufacturing defect within a period of 03 (three) months, counting from the delivery of the product to the consumer, by means of a purchase invoice. If there is any change in the structure of the product or defect occurs due to negligence of the assembler/consumer in relation to the assembly and handling instruction, free technical assistance will not be provided.

ACESSÓRIOS | ACCESORIOS | ACCESSORIES

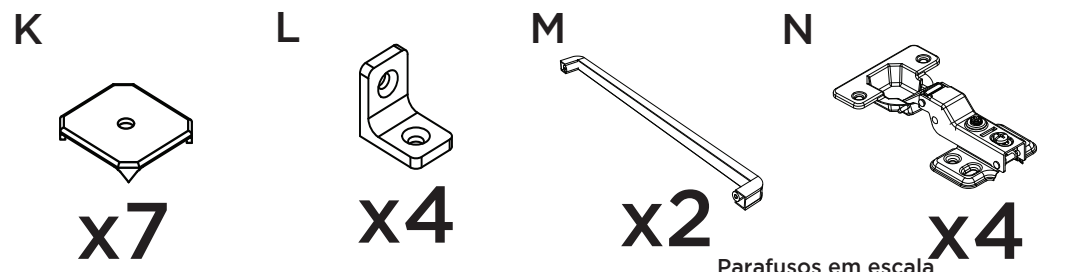
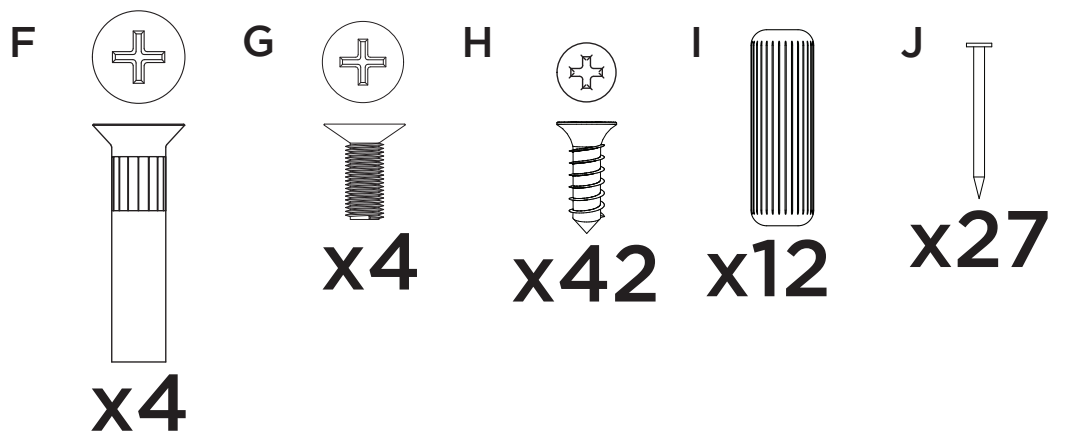
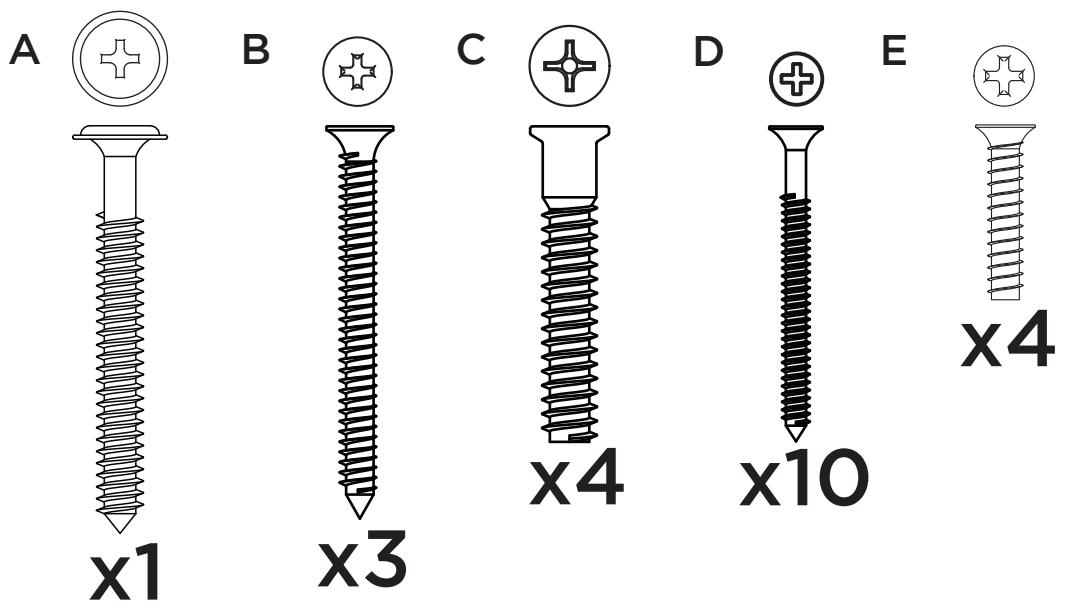

Parafusos em escala
Tornillos escalados
Scaled screws **1:1**

ACESSÓRIOS | ACCESORIOS | ACCESSORIES

O

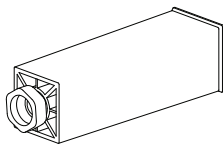

x4

P

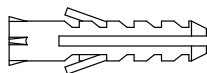

x1

Q

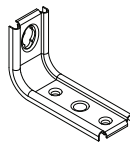

x1

R

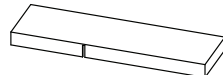

x1

S

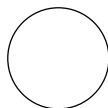

x14

T

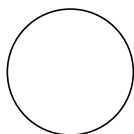

x4

U

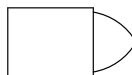

x3

V

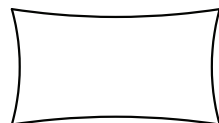

x1



Os parafusos (F/G) devem ser usados somente quando este módulo for acoplado a outro módulo componível Henn.



Los tornillos (F/G) se debe utilizar sólo cuando el módulo está conectado a otro módulo componible Henn.



Screws (F/G) are to be used only when this module is mated to another Henn buildable module.

LISTA DE PEÇAS | LISTA DE PIEZAS | LIST OF PIECES

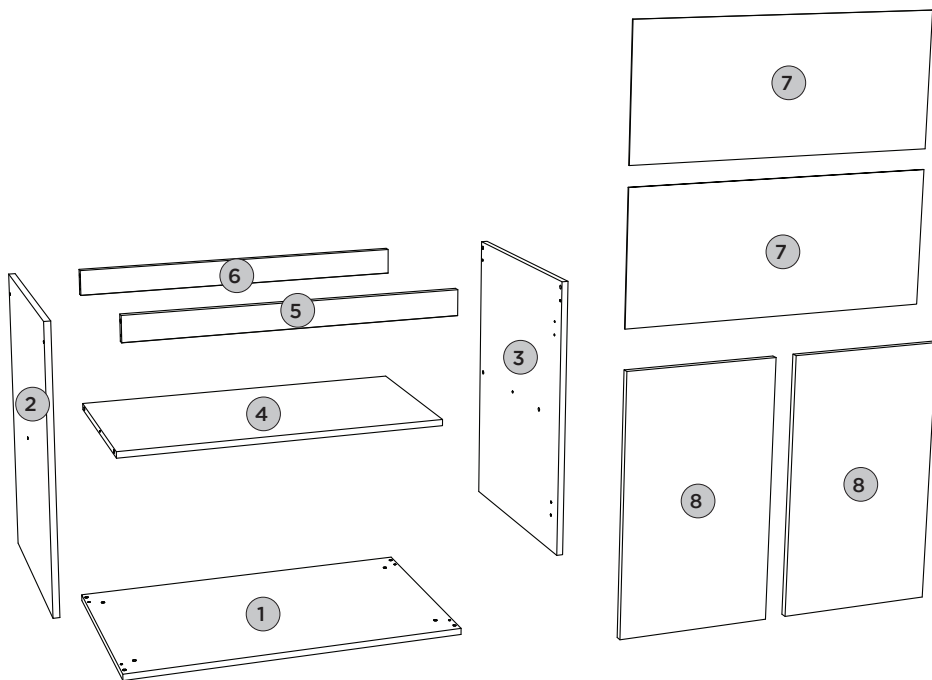

Item	Caixa Caja Box	Qty Ctd Qty	Descrição Descripción Description	Dimensões (mm) Dimensiones (mm) Dimensions (mm)		
				Comprimento Largo Length	Largura Ancho Width	Espessura Grosor Thickness
1	1/1	01	BASE BASE BASE	800	490	15
2	1/1	01	LATERAL ESQUERDA LATERAL IZQUIERDA LEFT SIDE	660	490	15
3	1/1	01	LATERAL DIREITA LATERAL DERECHA RIGHT SIDE	660	490	15
4	1/1	01	PRATELEIRA ESTANTE SHELF	768	400	15
5	1/1	01	TRAVESSA FRONTAL TRAVESAÑO FRONTAL FRONT CROSSBAR	768	60	15
6	1/1	01	TRAVESSA TRASEIRA TRAVESAÑO TRASERO REAR BUMPER	768	60	15
7	1/1	02	FUNDO FONDO BOTTOM	792	335	3
8	1/1	02	PORTA PUERTA DOOR	665	396	15





PASSO 1

ITM/C639-

PEÇAS REQUERIDAS

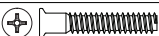
1	BASE	x1
2	LATERAL ESQUERDA	x1
3	LATERAL DIREITA	x1
4	PRATELEIRA	x1
5	TRAVESSA FRONTAL	x1
6	TRAVESSA TRASEIRA	x1

ACESSÓRIOS REQUERIDOS

C		04
I		12
O		04
V		

FERRAMENTAS NECESSÁRIAS

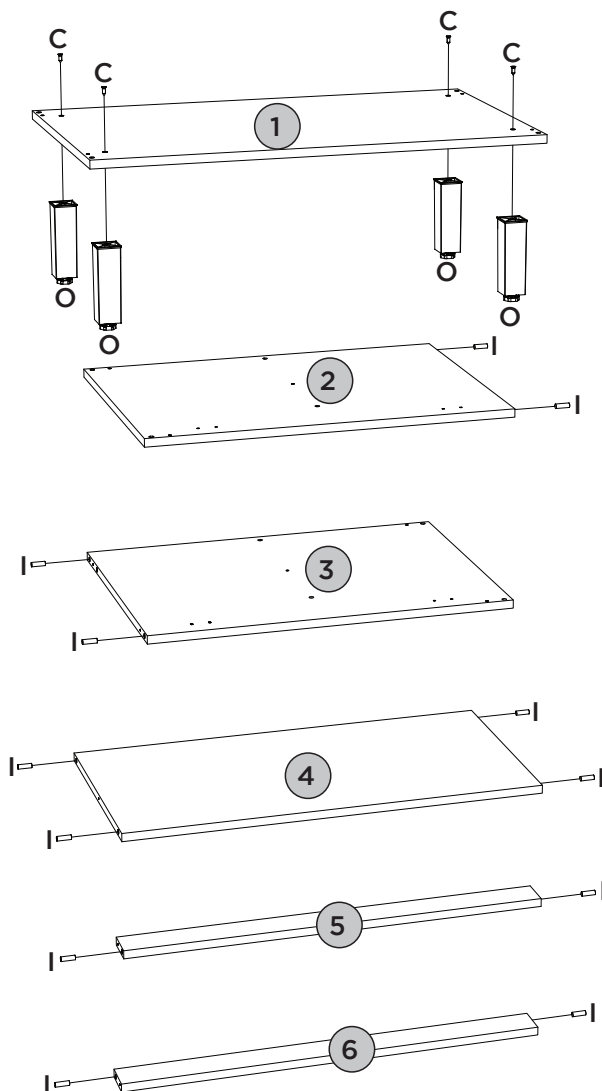
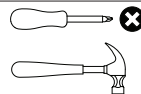

Utilizar o sachê de cola (V) em todas as cavilhas (I) do produto.



Con el pegamento sobre (V) en todos los pernos (I) producto.

Use the glue sachet (V) on all the pegs (I) of the product.

PASSO 2**PEÇAS REQUERIDAS**



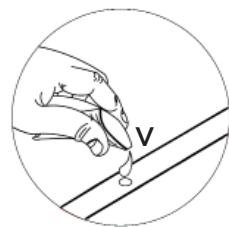
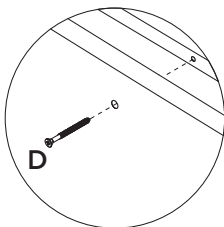
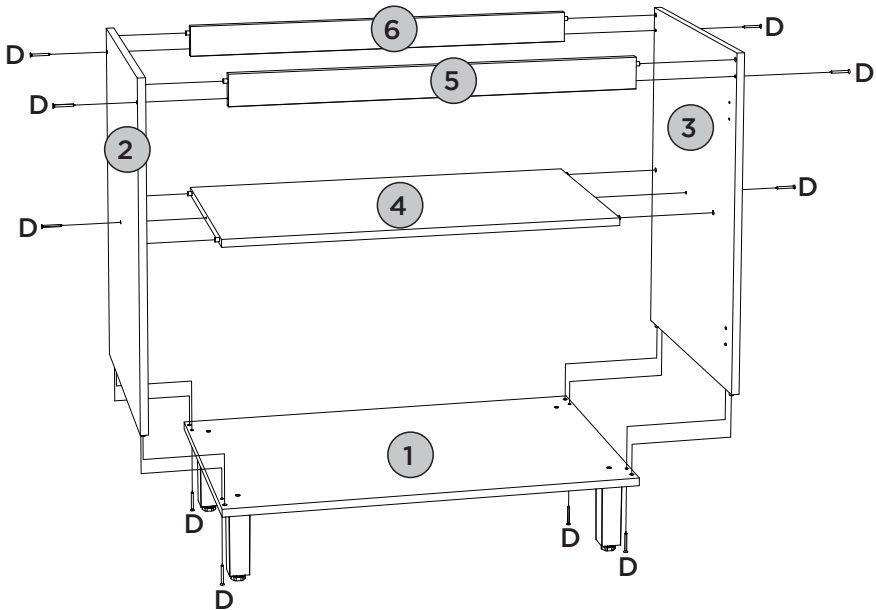

1	BASE	x1
2	LATERAL ESQUERDA	x1
3	LATERAL DIREITA	x1
4	PRATELEIRA	x1
5	TRAVESSA FRONTAL	x1
6	TRAVESSA TRASEIRA	x1

ACESSÓRIOS REQUERIDOS

D			10
V			

FERRAMENTAS NECESSÁRIAS

ACESSÓRIOS REQUERIDOS

B			03
H			08
L			04

FERRAMENTAS NECESSÁRIAS

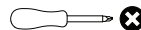

Esse tampo é opcional e é vendido separadamente (C904-128).

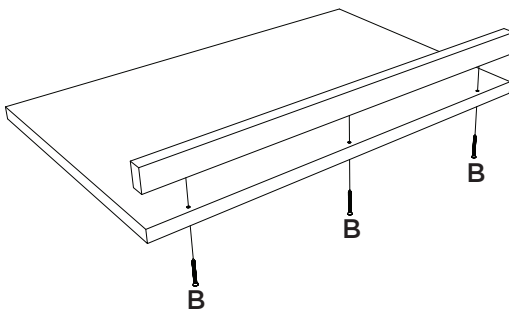

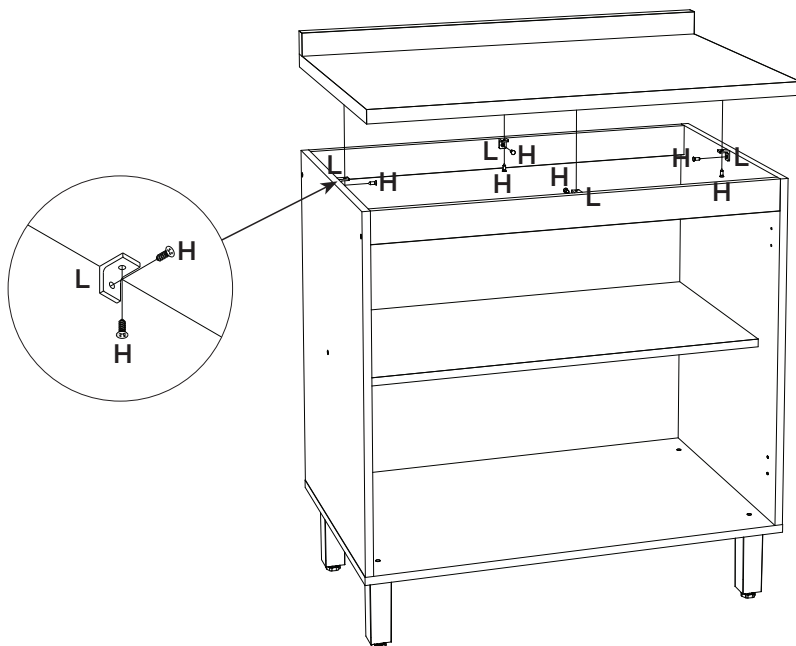

Esta vez es opcional y se vende por separado (C904-128).

This top is optional and is sold separately (C904-128).



ACESSÓRIOS REQUERIDOS

H			08
L			04

FERRAMENTAS NECESSÁRIAS

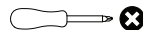

Esse tampo é opcional e é vendido separadamente (C908-128).

Esta vez es opcional y se vende por separado (C908-128).

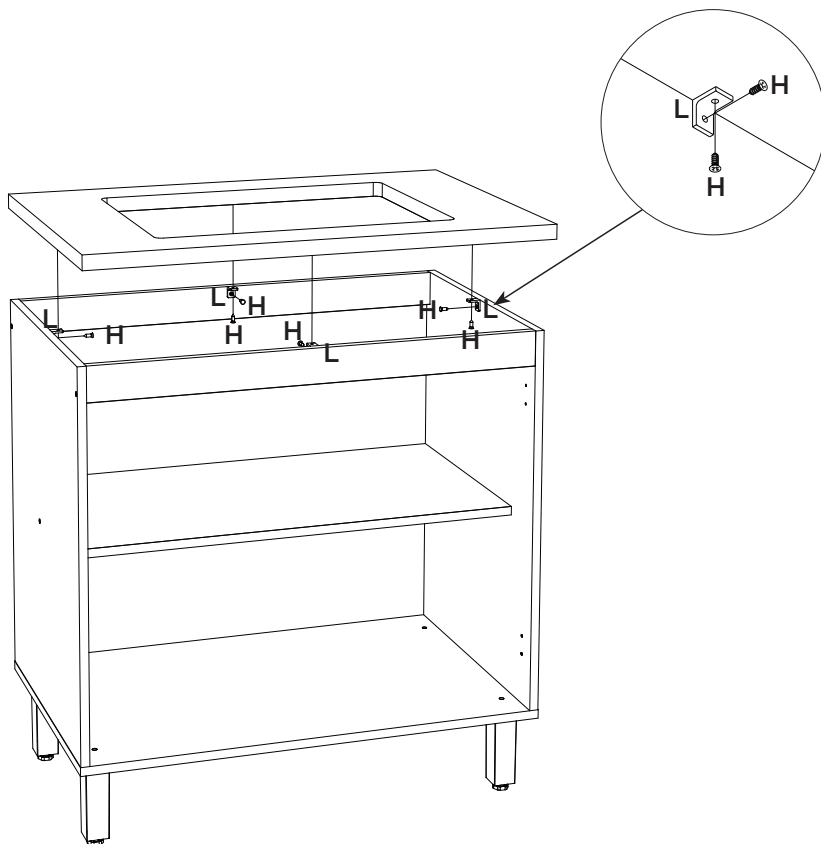

This top is optional and is sold separately (C908-128).



PEÇAS REQUERIDAS

7	FUNDO	x2
---	-------	----

ACESSÓRIOS REQUERIDOS

H		08
J		27
K		07

FERRAMENTAS NECESSÁRIAS

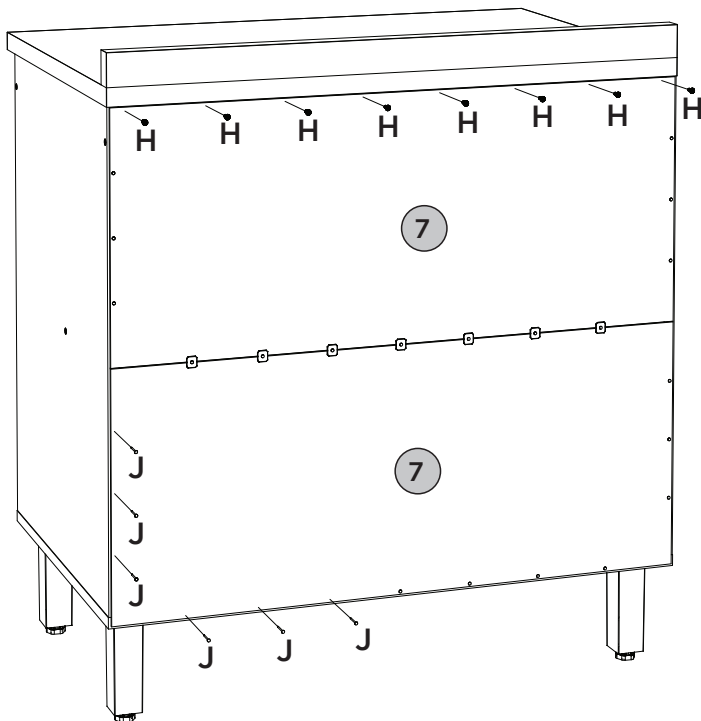
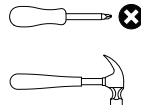

Fixar os pregos a uma distância de 100mm de um para outro.



Fijar las uñas a un distancia de 100mm uno a otro.

Fix the nails at a distance of 100mm from one to the other

PASSO 6**PEÇAS REQUERIDAS**

8	PORTA	x2
---	-------	----

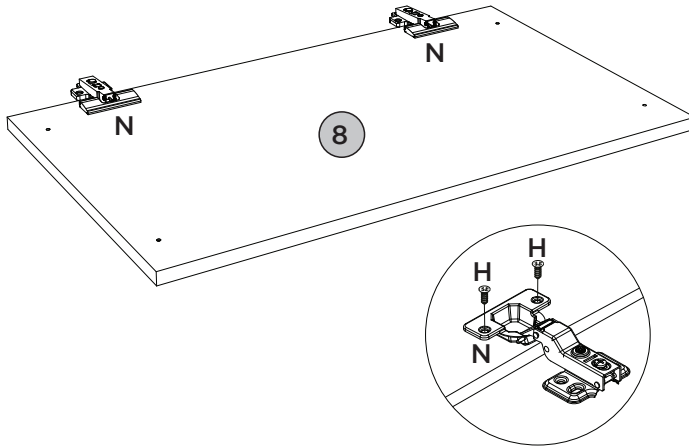
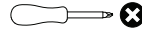

ACESSÓRIOS REQUERIDOS

H		08
N		04

FERRAMENTAS NECESSÁRIAS**PASSO 7****PEÇAS REQUERIDAS**

8	PORTA	x2
---	-------	----

ACESSÓRIOS REQUERIDOS

E		04
H		16
M		02

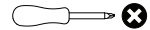
FERRAMENTAS NECESSÁRIAS

Para porta (8): Defina para o modo de perfuração.

Faça a furação passante para fixar o puxador (M).

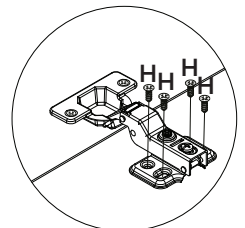
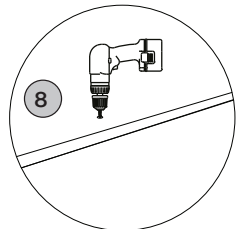
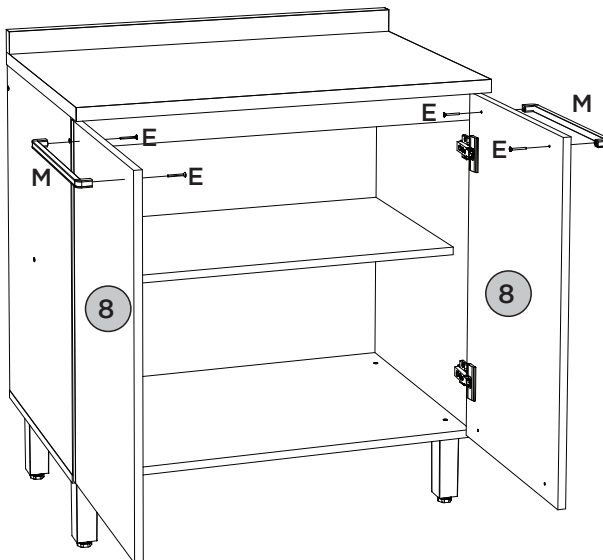

ACESSÓRIOS REQUERIDOS

A		01	R		01
H		02	S		14
P		01	T		04
Q		01	U		03

FERRAMENTAS NECESSÁRIAS



OU

Para parede: Ajustar no modo perfuração

Pesos máximos recomendados com carga distribuída
 Peso máximo recomendado con la carga distribuida
 Recommended maximum weight with distributed load.

PERFECT CORRECTION
 CORRECCIÓN PERFECTA

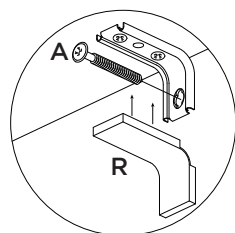
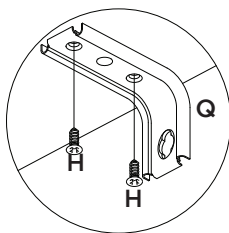
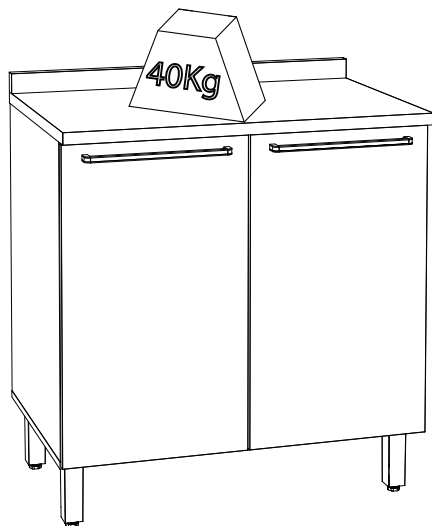
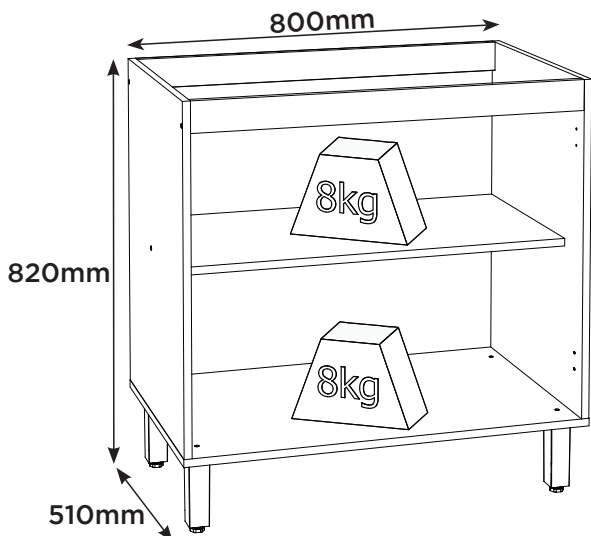
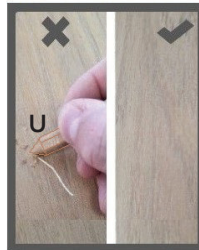

RECOMENDAÇÃO

Para fixar o móvel na parede usar o suporte de fixação (Q), o parafuso 4,0x14mm CHT (H), a Bucha 8mm (P) e o parafuso 5,0x50mm FLA (A).

RECOMENDACIÓN

Para conectar el móvil a la pared con el soporte (Q), tornillo 4,0x14mm CHT (H), el casquillo de 8 mm (P) y el 5,0 x50mm tornillo FLA (A).

RECOMMENDATION

To fix the furniture to the wall use the fixing bracket (Q), the 4,0x14mm CHT (H) screw, the 8mm bushing (P) and the 5.0x50mm FLA screw (A).

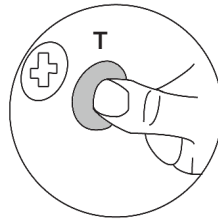
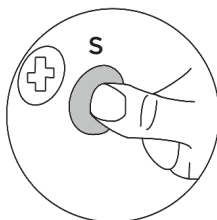

Produto Concluído
Producto terminado
Finished Product

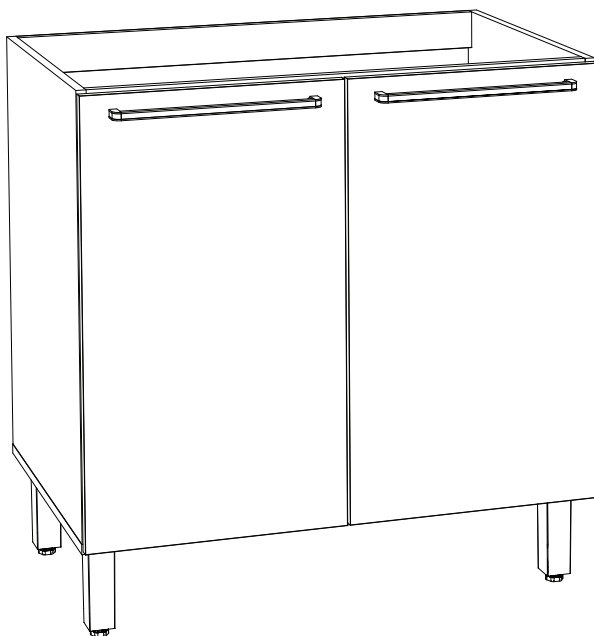

HENNInd. e Com. de Móveis Henn
Mondai - SC - Brasil

☎ +55 49 3674.3500

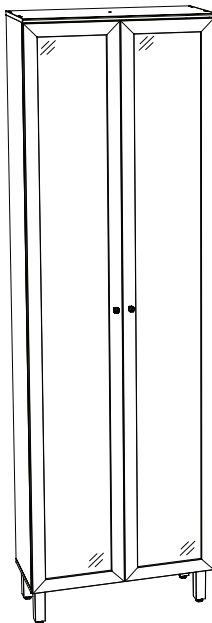
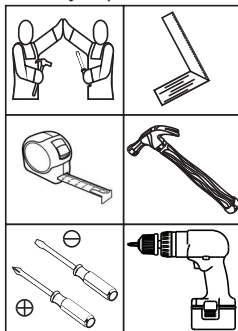
📷 📱 @moveishenn
www.henn.com.br**INSTRUÇÕES DE
MONTAGEM**INSTRUCCIONES DE MONTAJE
ASSEMBLY INSTRUCTIONS**Cristaleira 02 Portas Requite |
Gabinete 02 Puertas Requite | Cabinet 02 Doors Requite****C645-128 Nature
C645-217 Nature/Areia HP****Requisitos para montagem
Requisitos para la montaje
Assembly Requirements**

Imagens meramente ilustrativas,
não acompanha o produto.
Imágenes ilustrativas, no incluidas
con el producto.
Illustrative images, not included
with the product.

AVISO

Para limpeza de seu móvel, use uma flanela seca ou umedecida, e não utilize produtos químicos que possam danificar seu produto.

SISTEMA DE MONTAGEM

O sistema de montagem dos produtos, funciona de acordo com a ordem crescente dos números indicados no desenho. Ex: 01, 02, 03, 04... até a conclusão da montagem.

ASSISTÊNCIA TÉCNICA

Para solicitação de Assistência Técnica você consumidor deverá entrar em contato com o Lojista a qual você realizou a compra deste produto e solicitar a assistência técnica das peças avariadas. A garantia abrange todas as peças, partes e componentes que eventualmente venham apresentar defeito de fabricação no prazo de 03 (três) meses, contando a partir da entrega do produto ao consumidor, mediante nota fiscal de compra. Se houver qualquer alteração na estrutura do produto ou ocorrer defeito por negligência do montador/consumidor em relação a instrução de montagem e manuseio, não será fornecido assistência técnica gratuita.

ADVERTENCIA

Para limpieza de su móvil, use una flanela seca o húmeda, y no utilice productos químicos que puedan dañar su producto.

SISTEMA DE MONTAJE

El sistema de montaje de los productos funciona de acuerdo con el orden creciente de los números indicados en el dibujo. Ej.: 01, 02, 03, 04... hasta la conclusión del montaje.

ASISTENCIA TÉCNICA

Para solicitar Asistencia Técnica, el consumidor debe comunicarse con el Comercio que usted realizó la compra de este producto y solicita asistencia técnica para las partes dañadas. La garantía cubre todas las partes, piezas y componentes que eventualmente puedan presentar defecto de fabricación en el plazo de 03 (tres) meses, contados a partir de la entrega del producto al consumidor, mediante factura de compra. Si se produce algún cambio en la estructura del producto o se produce un defecto por negligencia del montador/consumidor en relación con las instrucciones de montaje y manipulación, no se prestará asistencia técnica gratuita.

NOTICE

To clean your furniture, use a dry or wet cloth, and do not use chemicals that may damage your product.

ASSEMBLY SYSTEM

The products' assembly system works according to the increasing order of the indicated numbers. For example: 01, 02, 03, 04 ... to the end of the assembly.

TECHNICAL ASSISTANCE

To request Technical Assistance, the consumer must contact the retailer from whom you purchased this product and request technical assistance for the damaged parts. The warranty covers all parts, parts and components that may eventually present a manufacturing defect within a period of 03 (three) months, counting from the delivery of the product to the consumer, by means of a purchase invoice. If there is any change in the structure of the product or defect occurs due to negligence of the assembler/consumer in relation to the assembly and handling instruction, free technical assistance will not be provided.

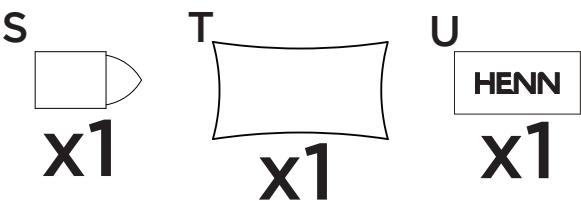
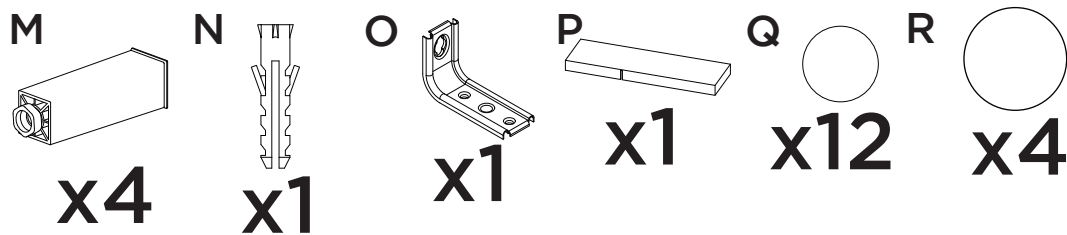
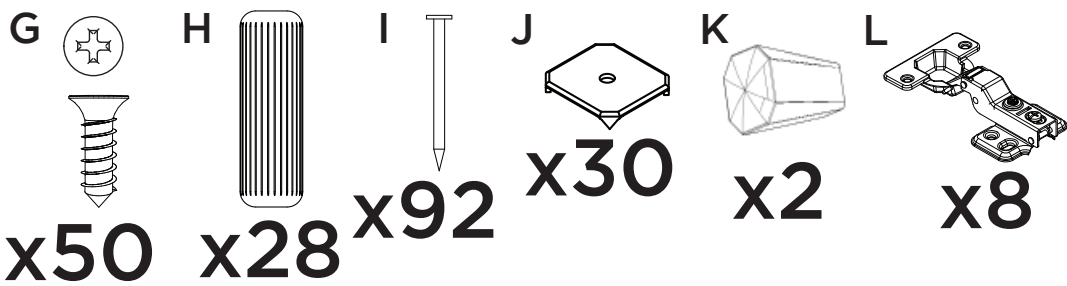
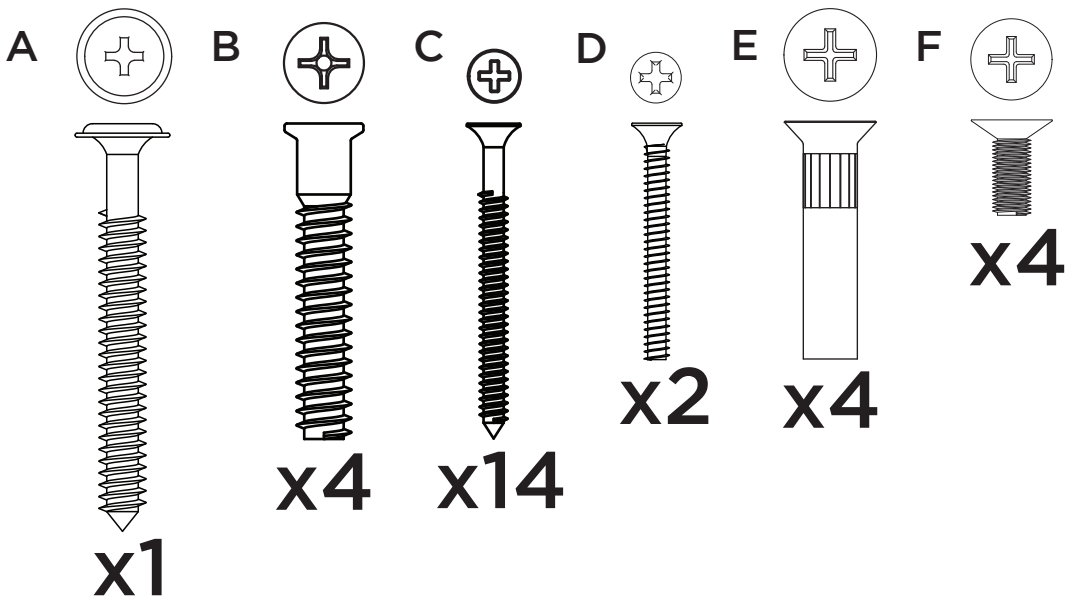

Parafusos em escada
Tornillos escalados
Scaled screws **1:1**

 Os parafusos (E/F) devem ser usados somente quando este módulo for acoplado a outro módulo componível Henn.

 Los tornillos (E/F) se debe utilizar sólo cuando el módulo está conectado a otro módulo componible Henn.

 Screws (E/F) are to be used only when this module is mated to another Henn buildable module.

LISTA DE PEÇAS | LISTA DE PIEZAS | LIST OF PIECES

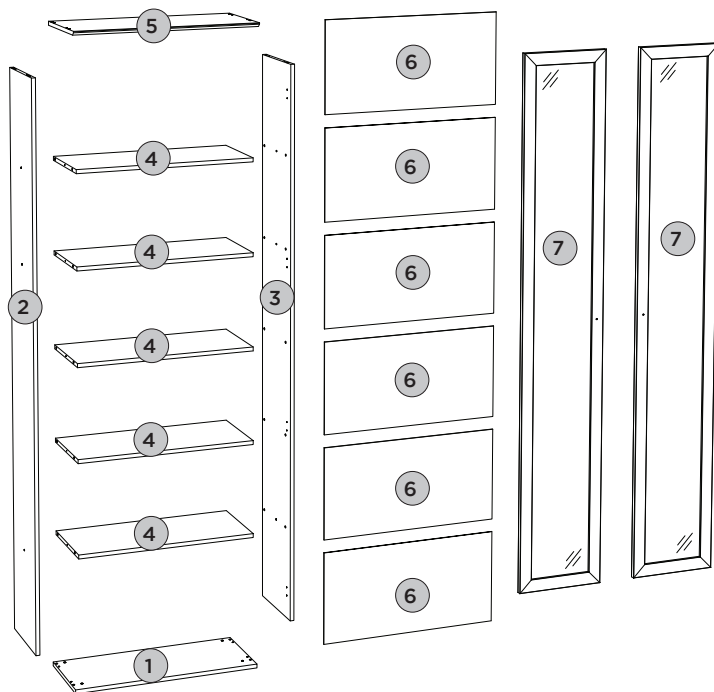





Item	Caja Caja Box	Qty Ctd Qty	Descrição Descripción Description	Dimensões (mm) Dimensiones (mm) Dimensions (mm)		
				Comprimento Largo Length	Largura Ancho Width	Espessura Grosor Thickness
1	1/2	01	BASE BASE BASE	715	295	15
2	2/2	01	LATERAL ESQUERDA LATERAL IZQUIERDA LEFT SIDE	2130	295	15
3	2/2	01	LATERAL DIREITA LATERAL DERECHA RIGHT SIDE	2130	295	15
4	1/2	05	PRATELEIRA ESTANTE SHELF	684	295	15
5	1/2	01	TAMPO TAPA TOP	715	322	15
6	2/2	06	FUNDO FONDO BOTTOM	708	358	3
7	2/2	02	PORTA DE VIDRO TEMPERADA REFLECTA PUERTA DE VIDRIO TEMPLADO REFLECTANTE REFLECT TEMPERED GLASS DOOR	2137	354	15

PASSO 1**PEÇAS REQUERIDAS**

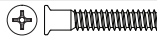
1	BASE	x1
2	LATERAL ESQUERDA	x1
3	LATERAL DIREITA	x1
4	PRATELEIRA	x5

ACESSÓRIOS REQUERIDOS

B		04
H		28
M		04
T		

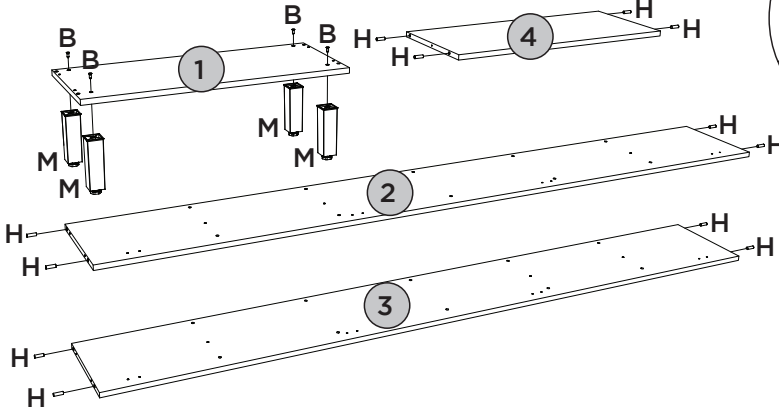
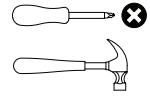
FERRAMENTAS NECESSÁRIAS

Utilizar o sachê de cola (T) em todas as cavilhas (H) do produto.



Con el pegamento sobre (T) en todos los pernos (H) producto.

Use the glue sachet (T) on all the pegs (H) of the product.

PASSO 2**PEÇAS REQUERIDAS**

1	BASE	x1
2	LATERAL ESQUERDA	x1
3	LATERAL DIREITA	x1
4	PRATELEIRA	x5
5	TAMPO	x1

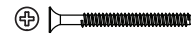
ACESSÓRIOS REQUERIDOS

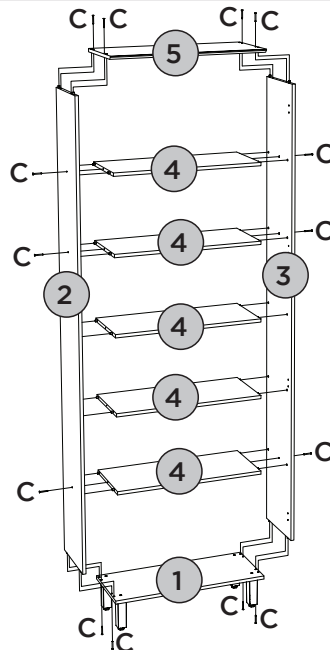
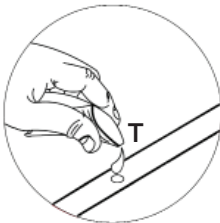
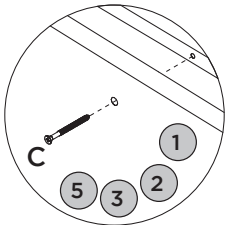
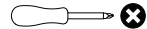

C		14
T		

FERRAMENTAS NECESSÁRIAS

PEÇAS REQUERIDAS

6	FUNDO	x6
---	-------	----

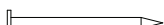
ACESSÓRIOS REQUERIDOS

I		92
J		30

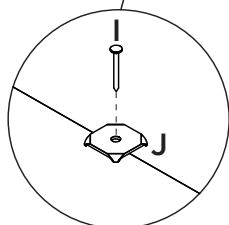
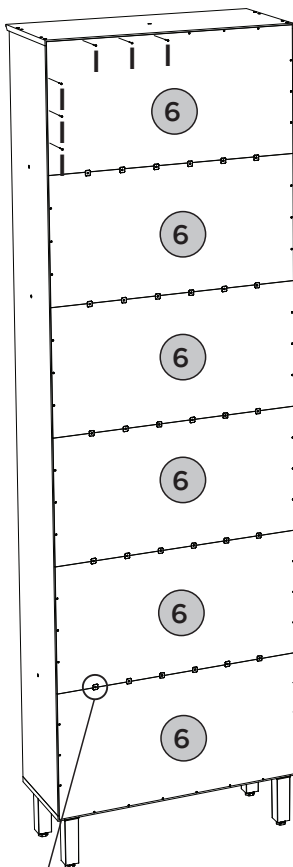
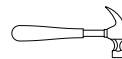
FERRAMENTAS NECESSÁRIAS

Fixar os pregos a uma distância de 100mm de um para outro.

Fijar las uñas a un distancia de 100mm uno a otro.

Fix the nails at a distance of 100mm from one to the other





PASSO 4

ITM/C645-

PEÇAS REQUERIDAS

7	PORTA DE VIDRO TEMPERADA REFLECTA	x2
---	--------------------------------------	----

ACESSÓRIOS REQUERIDOS

D		02
G		16
K		02
L		08

FERRAMENTAS NECESSÁRIAS

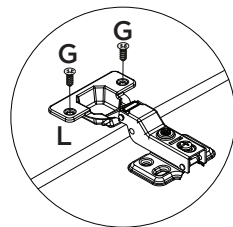
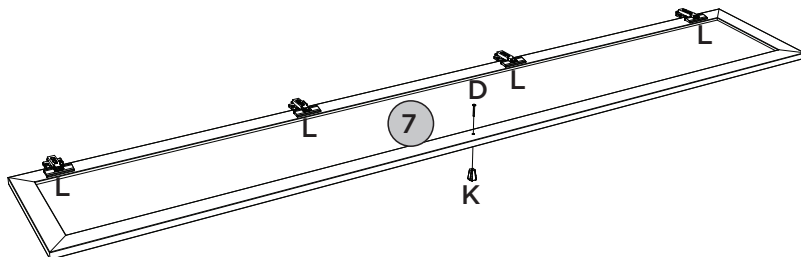
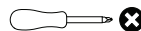

PASSO 5

PEÇAS REQUERIDAS

7	PORTA DE VIDRO TEMPERADA REFLECTA	x2
---	--------------------------------------	----

ACESSÓRIOS REQUERIDOS

G		32
---	---	----

FERRAMENTAS NECESSÁRIAS

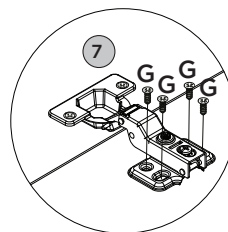
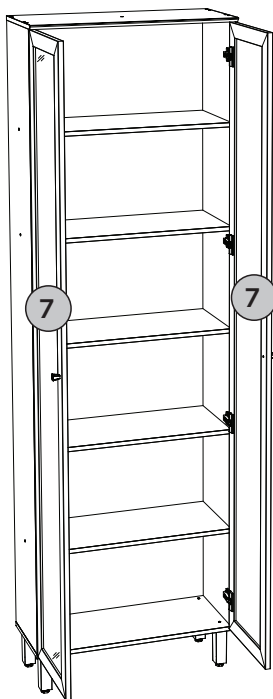
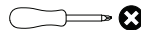

ACESSÓRIOS REQUERIDOS

A		01
G		02
N		01
O		01
P		01

Q		12
R		04
S		01
U		01

FERRAMENTAS NECESSÁRIAS



Para parede: Ajustar no modo perfuração
Para peça (5): Usar torque 5

Pesos máximos recomendados com carga distribuída
Peso máximo recomendado con la carga distribuida
Recommended maximum weight with distributed load.

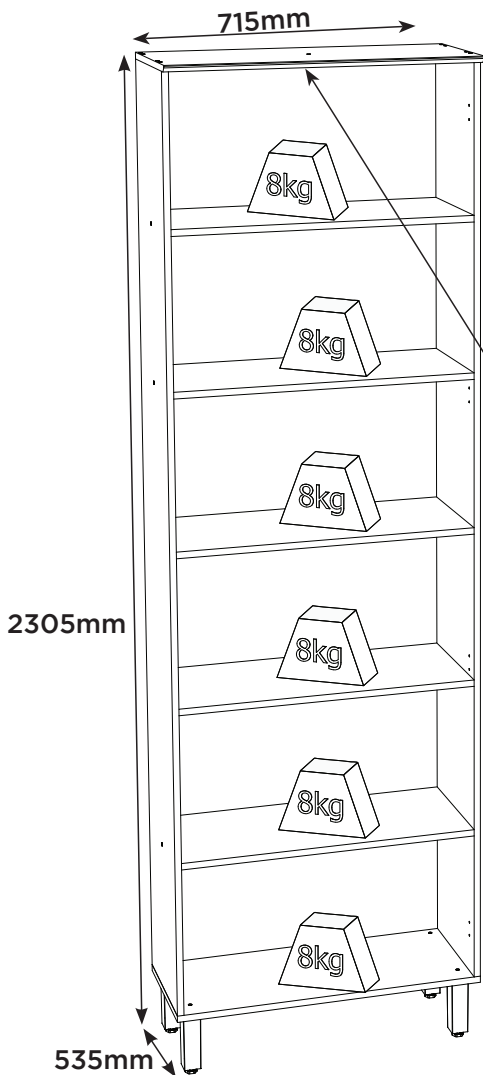

PERFECT CORRECTION
CORRECCIÓN PERFECTA

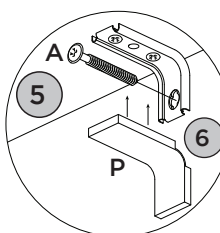
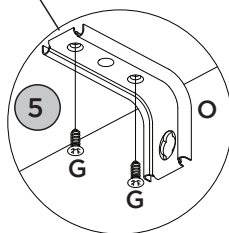
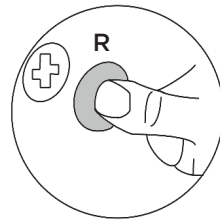
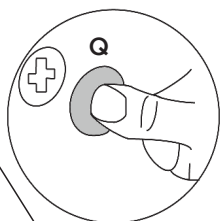
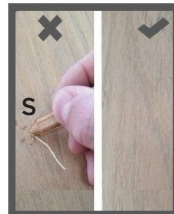

RECOMENDAÇÃO

Para fixar o móvel na parede usar o suporte de fixação (O), o parafuso 4,0x14mm CHT (G), a Bucha 8mm (N) e o parafuso 5,0x50mm FLA (A).

RECOMENDACIÓN

Para conectar el móvil a la pared con el soporte (O), tornillo 4,0x14mm CHT (G), el casquillo de 8 mm (N) y el 5,0 x50mm tornillo FLA (A).

RECOMMENDATION

To fix the furniture to the wall use the fixing bracket (O), the 4,0x14mm CHT (G) screw, the 8mm bushing (N) and the 5.0x50mm FLA screw (A).

Produto Concluído
Producto terminado
Finished Product

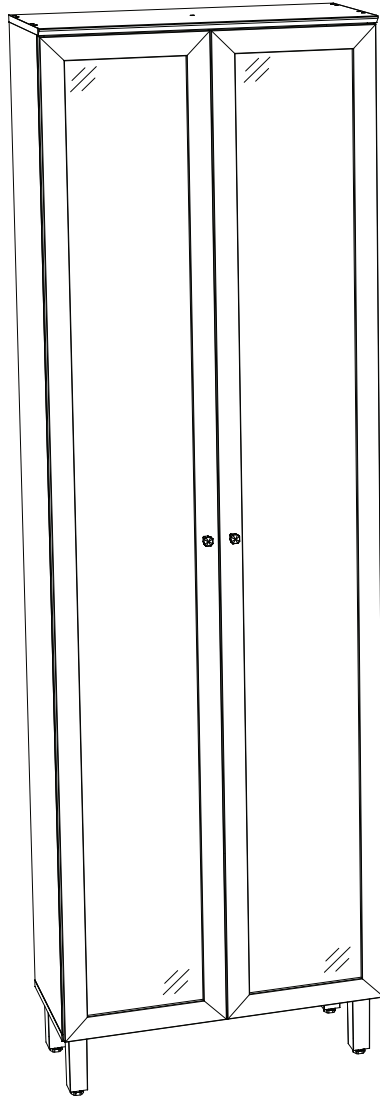

HENNInd. e Com. de Móveis Henn
Mondai - SC - Brasil

☎ +55 49 3674.3500

📷 📱 @moveishenn
www.henn.com.br**INSTRUÇÕES DE
MONTAGEM**INSTRUCCIONES DE MONTAJE
ASSEMBLY INSTRUCTIONS**Torre Quente 02 Fornos 715mm Requite |**

Torre Caliente 02 Hornos 715mm Requite | Hot Tower 02 Ovens 715mm Requite

C643-217 Nature/Areia HP

C643-218 Nature/Nature/Areia HP

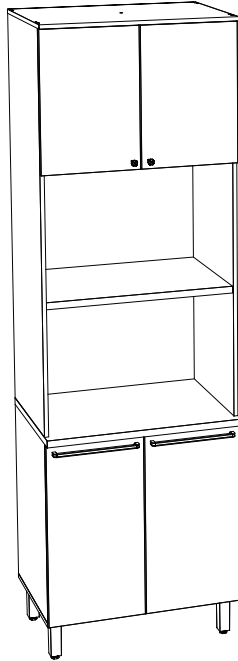
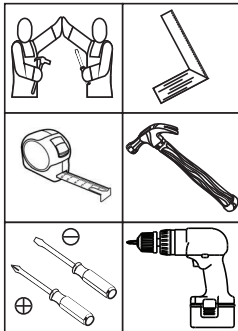
Requisitos para montagem
Requisitos para la montaje
Assembly Requirements

Imagens meramente ilustrativas,
não acompanha o produto.
Imágenes ilustrativas, no incluidas
con el producto.
Illustrative images, not included
with the product.

AVISO

Para limpeza de seu móvel, use uma flanela seca ou umedecida, e não utilize produtos químicos que possam danificar seu produto.

SISTEMA DE MONTAGEM

O sistema de montagem dos produtos, funciona de acordo com a ordem crescente dos números indicados no desenho. Ex: 01, 02, 03, 04... até a conclusão da montagem.

ASSISTÊNCIA TÉCNICA

Para solicitação de Assistência Técnica você consumidor deverá entrar em contato com o Lojista o qual você realizou a compra deste produto e solicitar a assistência técnica das peças avariadas. A garantia abrange todas as peças, partes e componentes que eventualmente venham apresentar defeito de fabricação no prazo de 03 (três) meses, contando a partir da entrega do produto ao consumidor, mediante nota fiscal de compra. Se houver qualquer alteração na estrutura do produto ou ocorrer defeito por negligência do montador/consumidor em relação a instrução de montagem e manuseio, não será fornecido assistência técnica gratuita.

ADVERTENCIA

Para limpieza de su móvil, use una flanela seca o húmeda, y no utilice productos químicos que puedan dañar su producto.

SISTEMA DE MONTAJE

El sistema de montaje de los productos funciona de acuerdo con el orden creciente de los números indicados en el dibujo. Ej.: 01, 02, 03, 04... hasta la conclusión del montaje.

ASISTENCIA TÉCNICA

Para solicitar Asistencia Técnica, el consumidor debe comunicarse con el Comercio que usted realizó la compra de este producto y solicita asistencia técnica para las partes dañadas. La garantía cubre todas las partes, piezas y componentes que eventualmente puedan presentar defecto de fabricación en el plazo de 03 (tres) meses, contados a partir de la entrega del producto al consumidor, mediante factura de compra. Si se produce algún cambio en la estructura del producto o se produce un defecto por negligencia del montador/consumidor en relación con las instrucciones de montaje y manipulación, no se prestará asistencia técnica gratuita.

NOTICE

To clean your furniture, use a dry or wet cloth, and do not use chemicals that may damage your product.

ASSEMBLY SYSTEM

The products' assembly system works according to the increasing order of the indicated numbers. For example: 01, 02, 03, 04 ... to the end of the assembly.

TECHNICAL ASSISTANCE

To request Technical Assistance, the consumer must contact the retailer from whom you purchased this product and request technical assistance for the damaged parts. The warranty covers all parts, parts and components that may eventually present a manufacturing defect within a period of 03 (three) months, counting from the delivery of the product to the consumer, by means of a purchase invoice. If there is any change in the structure of the product or defect occurs due to negligence of the assembler/consumer in relation to the assembly and handling instruction, free technical assistance will not be provided.

ACESSÓRIOS | ACCESORIOS | ACCESSORIES

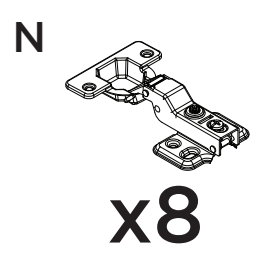
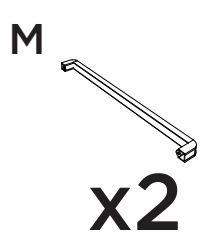
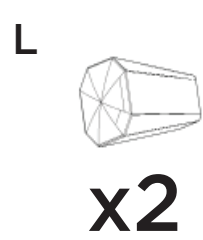
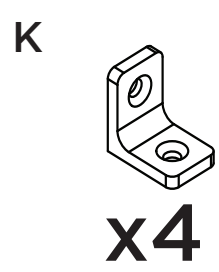
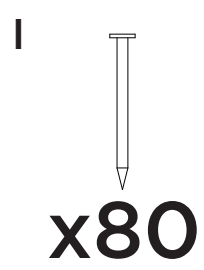
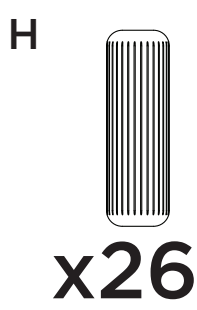
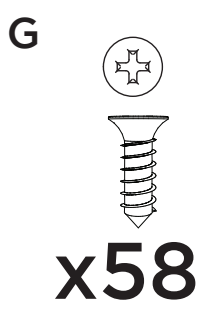
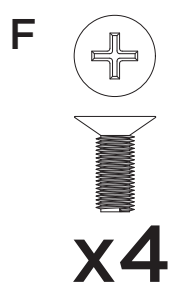
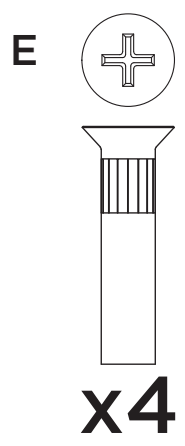
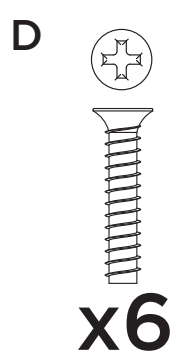
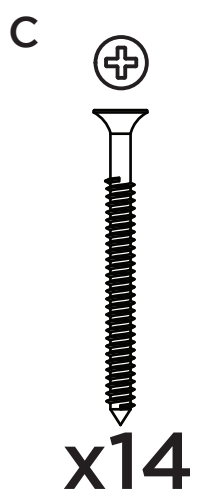
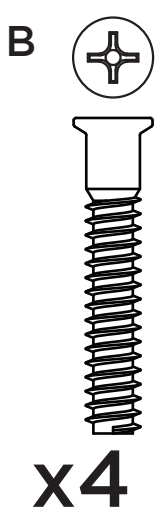
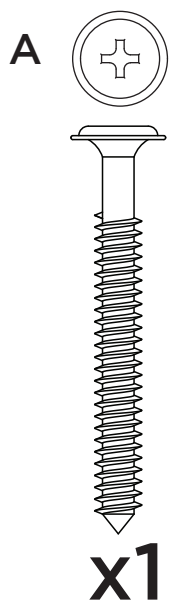

Parafusos em escala
Tornillos escalados
Scaled screws **1:1**

ACESSÓRIOS | ACCESORIOS | ACCESSORIES

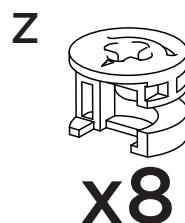
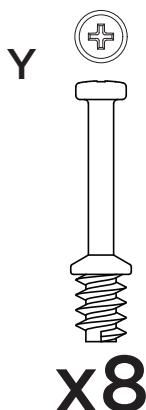
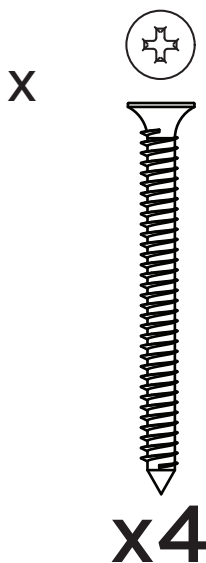
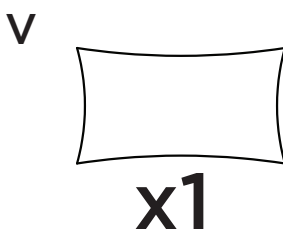
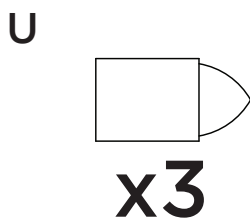
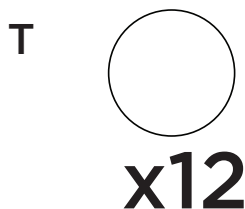
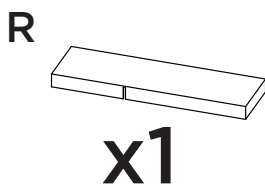
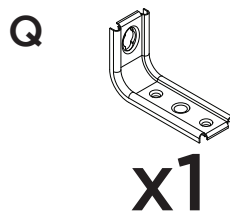
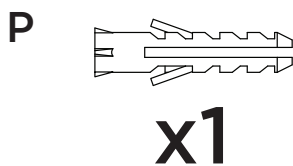
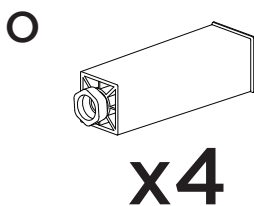

Os parafusos (E/F) devem ser usados somente quando este módulo for acoplado a outro módulo componível Henn.



Los tornillos (E/F) se debe utilizar sólo cuando el módulo está conectado a otro módulo componible Henn.



Screws (E/F) are to be used only when this module is mated to another Henn buildable module.

Parafusos em escala
Tornillos escalados
Scaled screws **1:1**

LISTA DE PEÇAS | LISTA DE PIEZAS | LIST OF PIECES

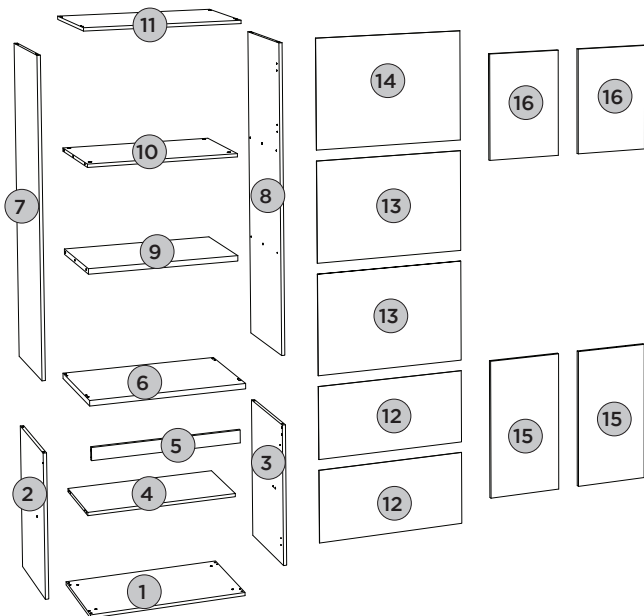

Item	Caixa Caja Box	Qty Ctd Qty	Descrição Descripción Description	Dimensões (mm) Dimensiones (mm)		
				Comprimento Largo Length	Largura Ancho Width	Espessura Grosor Thickness
1	1/1	01	BASE BASE BASE	715	490	15
2	1/1	01	LATERAL ESQUERDA INFERIOR LATERAL IZQUIERDA INFERIOR LEFT SIDE LOWER	660	490	15
3	1/1	01	LATERAL DIREITA INFERIOR LATERAL DERECHA INFERIOR RIGHT SIDE LOWER	660	490	15
4	1/1	01	PRATELEIRA ESTANTE SHELF	684	400	15
5	1/1	01	TRAVESSA FRONTAL TRAVESAÑO FRONTAL FRONT CROSS-BAR	684	60	15
6	1/1	01	TAMPO 25MM TAPA 25MM TOP 25MM	715	533	25
7	1/1	01	LATERAL ESQUERDA SUPERIOR LATERAL IZQUIERDA SUPERIOR UPPER LEFT SIDE	1445	490	15
8	1/1	01	LATERAL DIREITA SUPERIOR LATERAL DERECHA SUPERIOR UPPER RIGHT SIDE	1445	490	15
9	1/1	01	PRATELEIRA CENTRAL ESTANTE CENTRAL CENTRAL SHELF	684	480	25
10	1/1	01	BASE AÉREO BASE AEREO AIR BASE	684	490	15
11	1/1	01	TAMPO TAPA TOP	715	517	15
12	1/1	02	FUNDO INFERIOR FONDO INFERIOR LOWER BACKGROUND	708	343	3
13	1/1	02	FUNDO CENTRAL FONDO CENTRAL CENTRAL FUND	708	475	3
14	1/1	01	FUNDO SUPERIOR FONDO SUPERIOR UPPER BACKGROUND	708	517	3
15	1/1	02	PORTA INFERIOR PUERTA INFERIOR LOWER DOOR	665	354	15
16	1/1	02	PORTA PUERTA DOOR	508	354	15





PASSO 1

ITM/C643-

PEÇAS REQUERIDAS

1	BASE	x1
2	LATERAL ESQUERDA INFERIOR	x1
3	LATERAL DIREITA INFERIOR	x1
4	PRATELEIRA	x1
5	TRAVESSA FRONTAL	x1

ACESSÓRIOS REQUERIDOS

B		04
H		14
O		04
V		

FERRAMENTAS NECESSÁRIAS

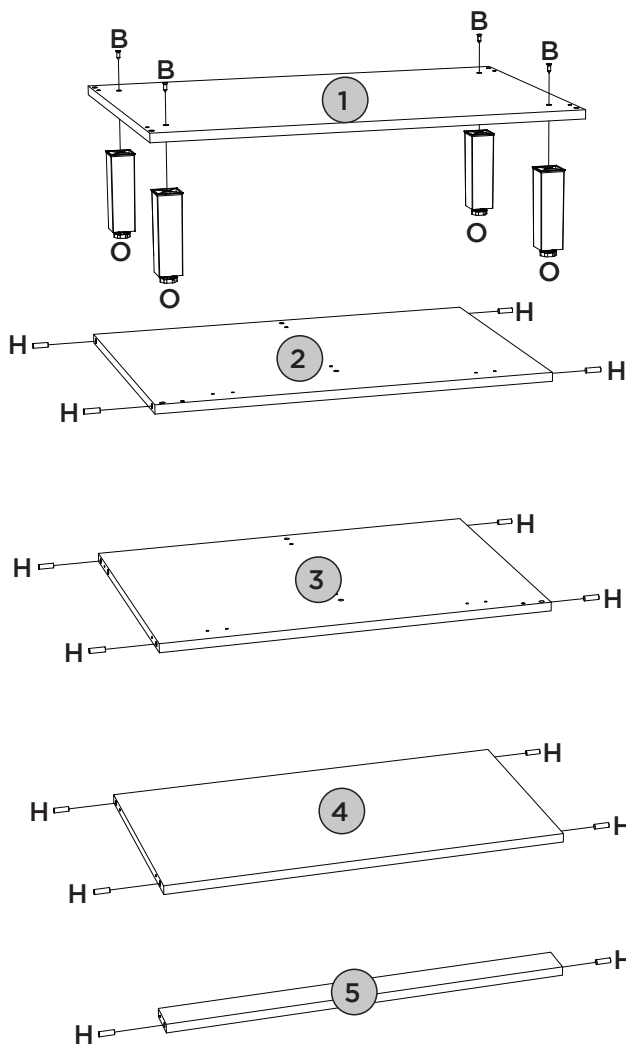
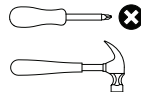

Utilizar o sachê de cola (V) em todas as cavilhas (H) do produto.

Con el pegamento sobre (V) en todos los pernos (H) do producto.

Use the glue sachet (V) on all the pegs (H) of the product.



PASSO 2

ITM/C643-

PEÇAS REQUERIDAS

7	LATERAL ESQUERDA SUPERIOR	x1
8	LATERAL DIREITA SUPERIOR	x1
9	PRATELEIRA CENTRAL	x1
10	BASE AÉREO	x1

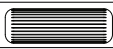
ACESSÓRIOS REQUERIDOS

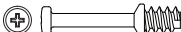
H		12
V		
Y		08

FERRAMENTAS NECESSÁRIAS

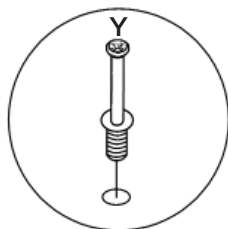
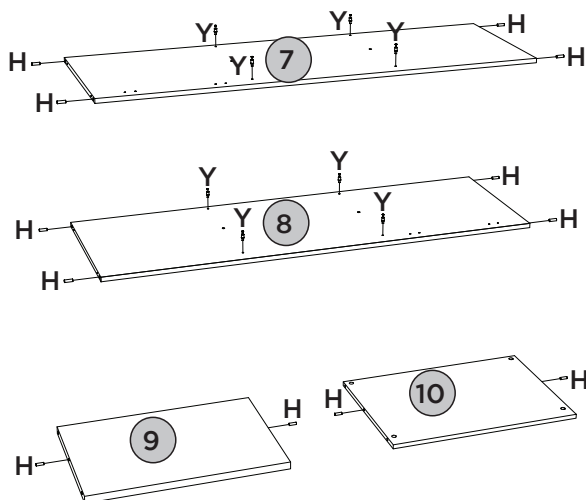
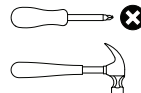



PASSO 3

PEÇAS REQUERIDAS

1	BASE	x1
2	LATERAL ESQUERDA INFERIOR	x1
3	LATERAL DIREITA INFERIOR	x1
4	PRATELEIRA	x1
5	TRAVESSA FRONTAL	x1

ACESSÓRIOS REQUERIDOS

C		10
V		



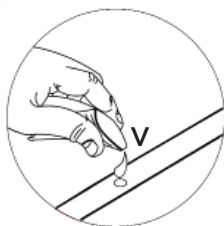
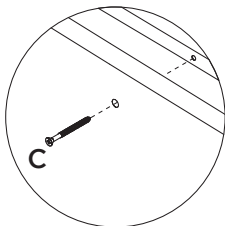
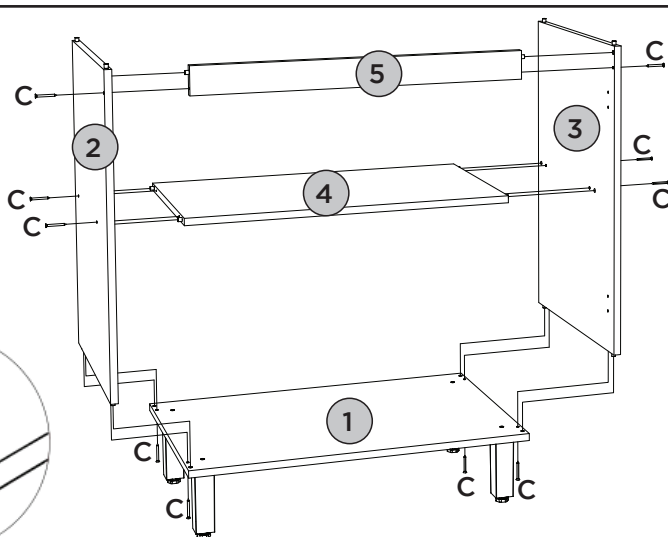
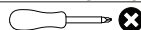

FERRAMENTAS NECESSÁRIAS



PEÇAS REQUERIDAS

6	TAMPO 25MM	x1
7	LATERAL ESQUERDA SUPERIOR	x1
8	LATERAL DIREITA SUPERIOR	x1
9	PRATELEIRA CENTRAL	x1
10	BASE AÉREO	x1
11	TAMPO	x1

ACESSÓRIOS REQUERIDOS

C		04
V		
X		04
Z		08

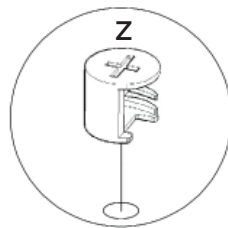
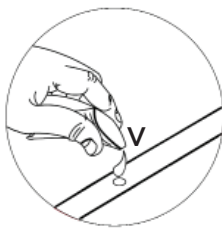
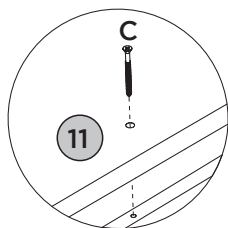
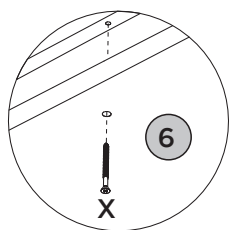
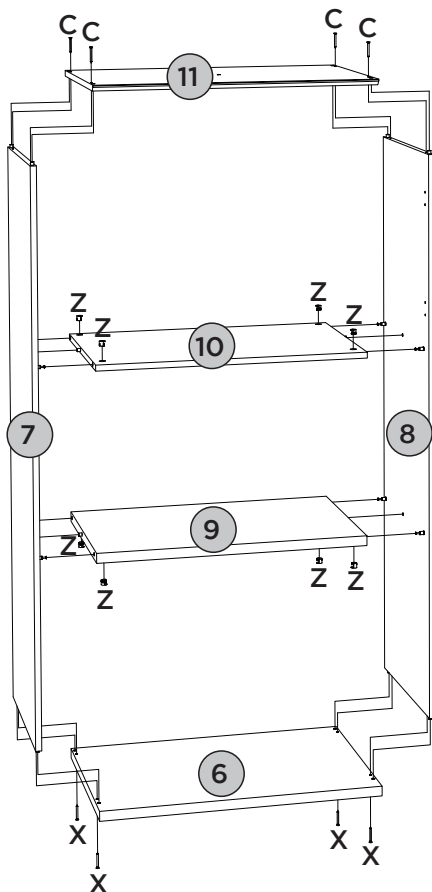
FERRAMENTAS NECESSÁRIAS

PASSO 5

ITM/C643-

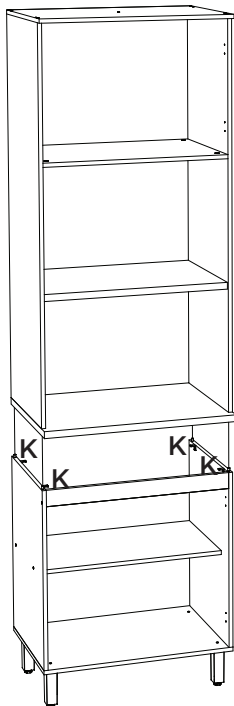

ACESSÓRIOS REQUERIDOS

G		08
K		04
V		

FERRAMENTAS NECESSÁRIAS

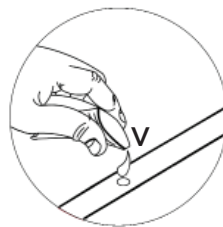
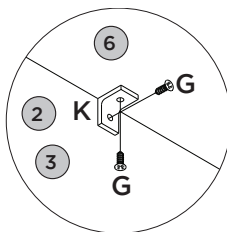
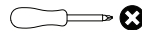

PASSO 6

PEÇAS REQUERIDAS

12	FUNDO INFERIOR	x2
13	FUNDO CENTRAL	x2
14	FUNDO SUPERIOR	x1

ACESSÓRIOS REQUERIDOS

I		80
J		24

FERRAMENTAS NECESSÁRIAS

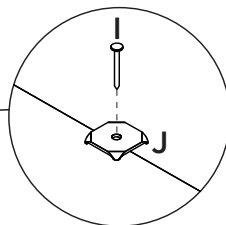
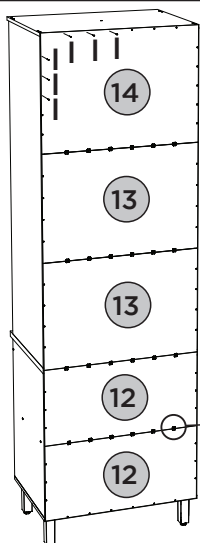
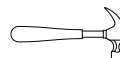

Fixar os pregos a uma distância de 100mm de um para outro.

Fijar las uñas a un distancia de 100mm uno a otro.

Fix the nails at a distance of 100mm from one to the other

PEÇAS REQUERIDAS

15	PORTA INFERIOR	x2
16	PORTA	x2

ACESSÓRIOS REQUERIDOS

G		16
N		08



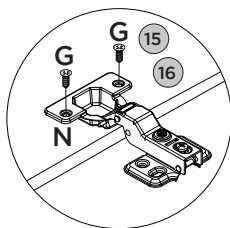
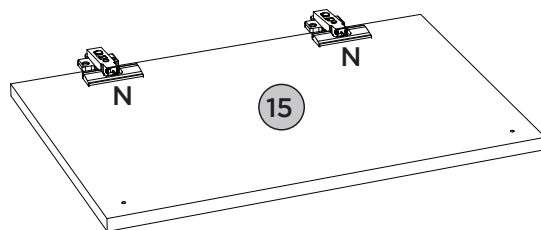
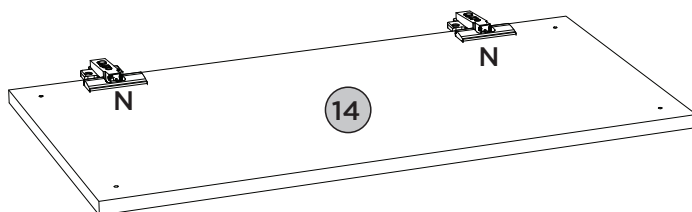
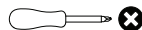



FERRAMENTAS NECESSÁRIAS



PEÇAS REQUERIDAS

15	PORTA INFERIOR	x2
16	PORTA	x2







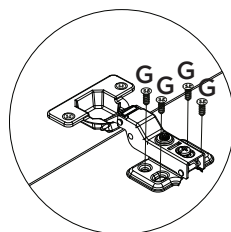
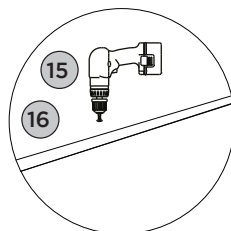
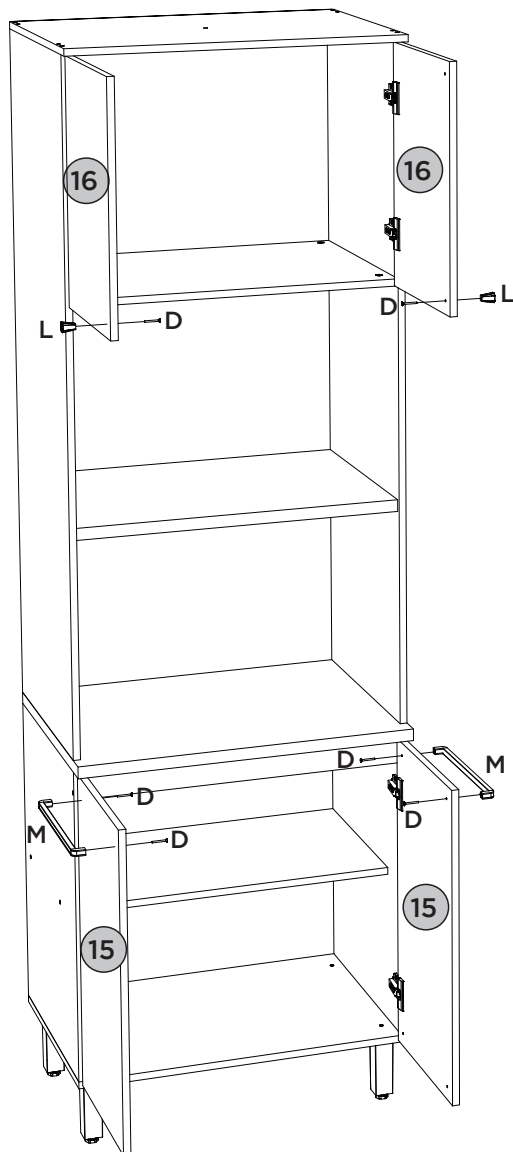
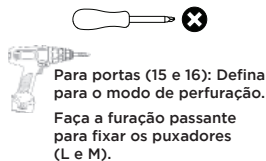

ACESSÓRIOS REQUERIDOS

D	 	06
G	 	32
L		02
M		02

FERRAMENTAS NECESSÁRIAS

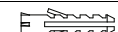

ACESSÓRIOS REQUERIDOS

A		01	S		16
G		02	T		12
P		01	U		03
Q		01	W		01
R		01			

FERRAMENTAS NECESSÁRIAS



OU

Para parede: Ajustar no modo perfuração
Para peça (11): Usar torque 5

Pesos máximos recomendados com carga distribuída
Peso máximo recomendado con la carga distribuida
Recommended maximum weight with distributed load.

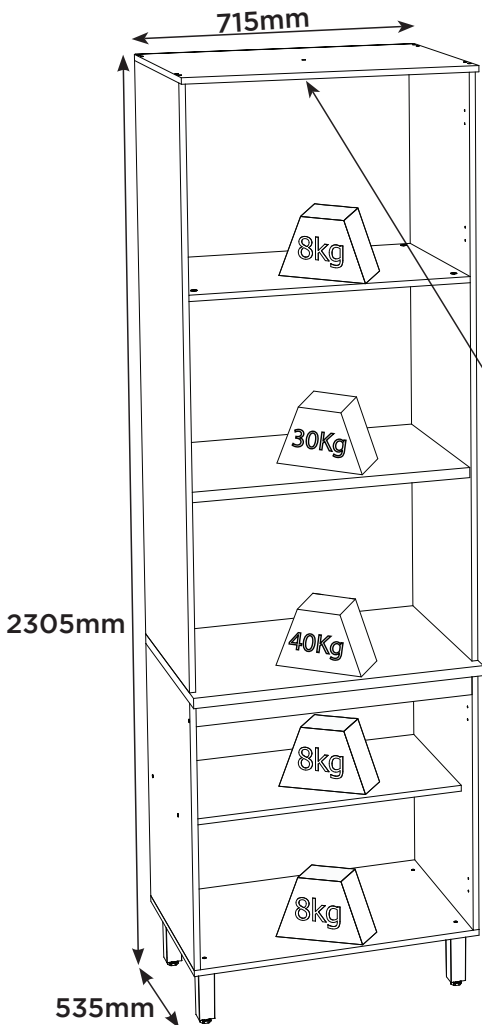

PERFECT CORRECTION
CORRECCIÓN PERFECTA

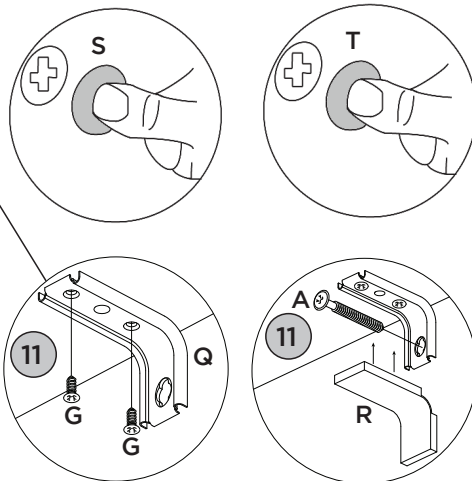
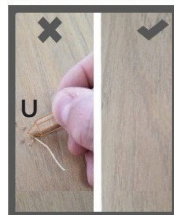

RECOMENDAÇÃO

Para fixar o móvel na parede usar o suporte de fixação (Q), o parafuso 4,0x14mm CHT (G), a Bucha 8mm (P) e o parafuso 5,0x50mm FLA (A).

RECOMENDACIÓN

Para conectar el móvil a la pared con el soporte (Q), tornillo 4,0x14mm CHT (G), el casquillo de 8 mm (P) y el 5,0 x50mm tornillo FLA (A).

RECOMMENDATION

To fix the furniture to the wall use the fixing bracket (Q), the 4,0x14mm CHT (G) screw, the 8mm bushing (P) and the 5.0x50mm FLA screw (A).

Producto Concluído
Producto terminado
Finished Product

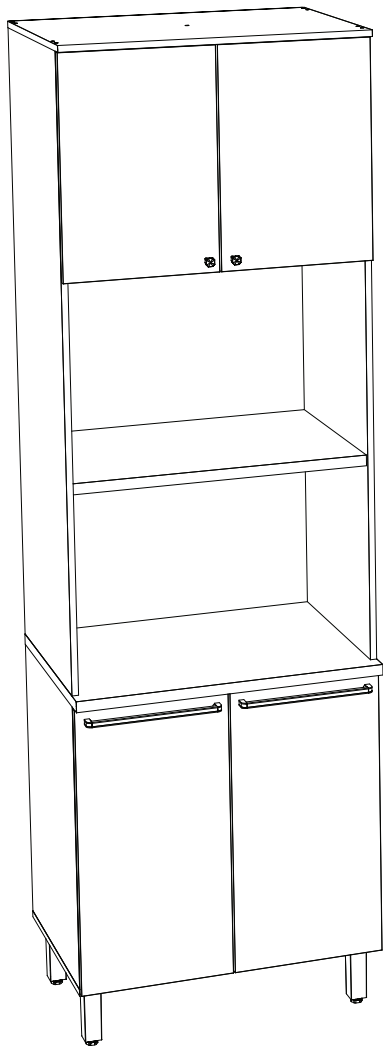

HENNInd. e Com. de Móveis Henn
Mondai - SC - Brasil

☎ +55 49 3674.3500

📧 @moveishenn
www.henn.com.br**INSTRUÇÕES DE MONTAGEM**INSTRUCCIONES DE MONTAJE
ASSEMBLY INSTRUCTIONS**Tampo Cooktop 800mm | Tampo Cooktop 800mm | Cooktop top 800mm**

- C908-23 Duna
- C908-33 Nero
- C908-114 Calcare

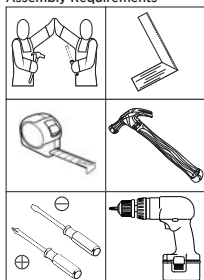
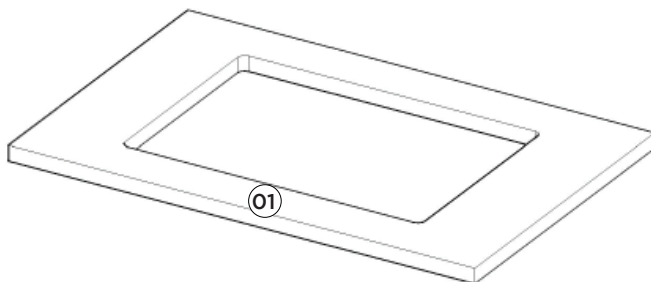
Requisitos para montagem
Requisitor para la montaje
Assembly RequirementsImagens meramente ilustrativas
Imágenes meramente ilustrativas
Images for illustration only**AVISO**

Para limpeza de seu móvel, use uma flanela seca ou umedecida, e não utilize produtos químicos que possam danificar seu produto.

SISTEMA DE MONTAGEM

O sistema de montagem dos produtos, funciona de acordo com a ordem crescente dos números indicados no desenho. Ex: 01, 02, 03, 04... até a conclusão da montagem.

ADVERTENCIA

Para limpieza de su móvil, use una franela seca o húmeda, y no utilice productos químicos que puedan dañar su producto.

SISTEMA DE MONTAJE

El sistema de montaje de los productos funciona de acuerdo con el orden creciente de los números indicados en el dibujo. Ej.: 01, 02, 03, 04... hasta la conclusión del montaje.

NOTICE

To clean your furniture, use a dry or wet cloth, and do not use chemicals that may damage your product.



ASSEMBLY SYSTEM

The products' assembly system works according to the increasing order of the indicated numbers. For example: 01, 02, 03, 04 ... to the end of the assembly.

Lista de Peças | Lista de piezas | List of parts

Item	Caixa Caja Box	Qty Ctd Qty	Descrição Descripción Description	Medidas (mm) Dimensions (mm) Size (measure- ments) (mm)
01	1/1	01	Tampo Tapa Top	800x533x25

Ferragens | Herrajes | Hardware

A		08x	B		04x
Parafuso 3,5x14mm FLA. Tornillo 3,5x14mm FLA. Screw 3,5x14mm FLA.			Cantoneira plástica Cantонера plástica Plastic angle brackets		

 Estas ferragens constam no Pacote do respectivo Balcão.
Estos herrajes constan en el Paquete del respectivo Balcón.
These hardware are included in the Package of the respective Counter.

Esse tampo é opcional e é vendido separadamente

Esta vez es opcional y se vende por separado

This top is optional and is sold separately

Exemplo de como fixar o Tampo Cooktop no produto.

Ejemplo de cómo fijar el Tablero Cooktop en el producto.

Example of how to secure the Cooktop Top to the product.

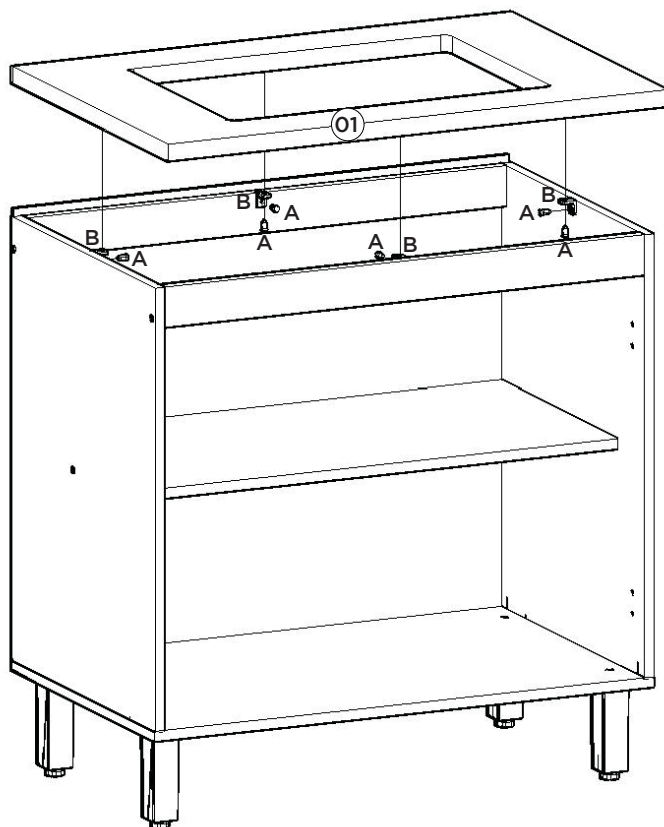

Agora que você já comprou o seu móvel, ele merece ser montado do jeito certo.

Erros de montagem causam mais de **60%** dos danos em móveis.

Por que contratar?

Tranquilidade do **início ao fim** da montagem



PROFISSIONAIS QUALIFICADOS

Especialistas certificados na **MadeiraMadeira Serviços**.



FERRAMENTAS PROFISSIONAIS

que **protegem** seus móveis.



AGENDAMENTO EM 24 HORAS

escolha a data e o turno **ideais para** você.



GARANTIA DE 3 MESES

de cobertura **completa**.

Mais de 1 MILHÃO DE MONTAGENS
★ com avaliação **4.7** ★

Mariana S., São Paulo

"Chegaram no horário e montaram tudo rapidamente. Serviço incrível!"



Carlos R., Belo Horizonte

"Tentei montar sozinho e foi um desastre. Com a **MadeiraMadeira Serviços** ficou perfeito."



Ana P., Rio de Janeiro

"Agendamento ágil e **montagem pontual e perfeita**. Recomendo demais!"



Agende agora pelo
QR Code



Madeira**Madeira** Serviços · Atendimento em todo o Brasil

Escaneie o QRCode