

Instruções de Montagem

Instrucciones de Montage

Assembly Instructions

REF.

VN-8009

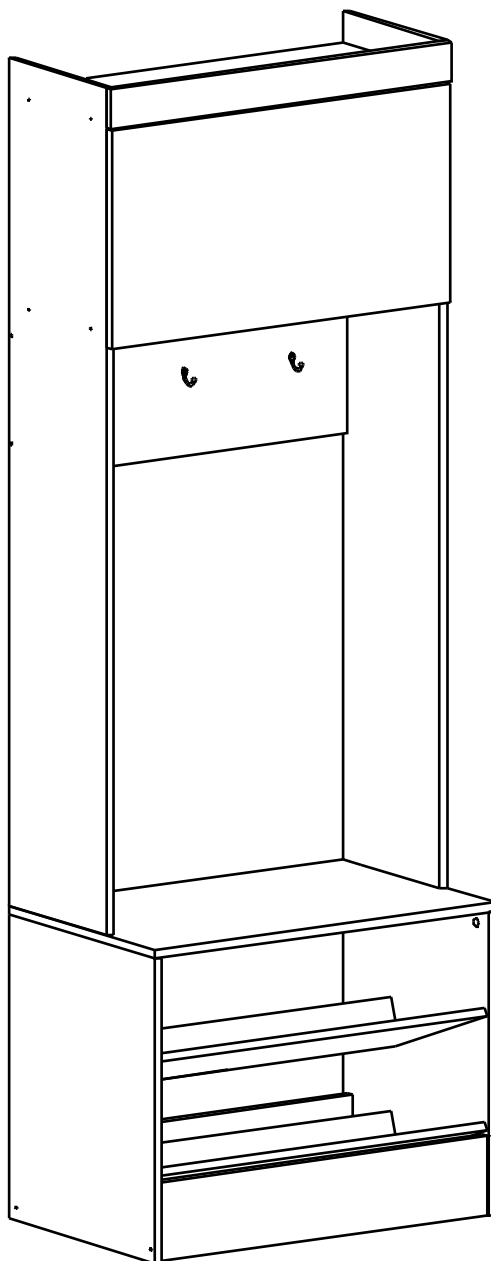

HECOL

móveis

Rua Arlindo Baccin, 601 - Lot. Vinhedos,
Bento Gonçalves, RS - CEP: 95707-150

Fone: (54) 3454-5900

Email: contato@hecolmoveis.com.br

Site: www.hecolmoveis.com.br

LISTA DE PEÇAS

Nº PEÇA	CÓD. IND.	DESCRIÇÃO	QTD.	COMP. (mm)	LARG. (mm)	ESP. (mm)
01		Lateral Dir Inferior	1	536	450	MDP 15
02		Lateral Dir Superior	1	1494	300	MDP 15
03		Lateral Esq Inferior	1	536	450	MDP 15
04		Lateral Esq Superior	1	1494	300	MDP 15
05		Tampo	1	710	450	MDP 15
06		Base Superior	1	680	300	MDP 15
07		Base Intermediária	1	680	300	MDP 15
08		Base Sapateira	2	680	300	MDP 15
09		Porta Basculante	1	706	385	MDP 15
10		Trav Costa Sapateira	2	680	70	MDP 15
11		Rodapé	2	680	140	MDP 15
12		Vista Superior	1	710	70	MDP 15
13		Painel	1	680	300	MDP 15
14		Costa Inferior	1	700	425	HDF 3
15		Costa Superior	1	700	375	HDF 3

Para a montagem do produto você vai precisar de:

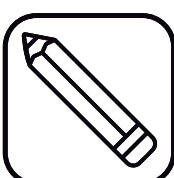
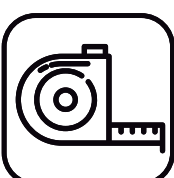
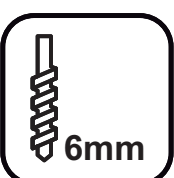
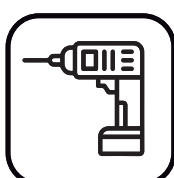
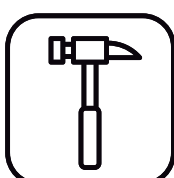

LISTA DE PEÇAS

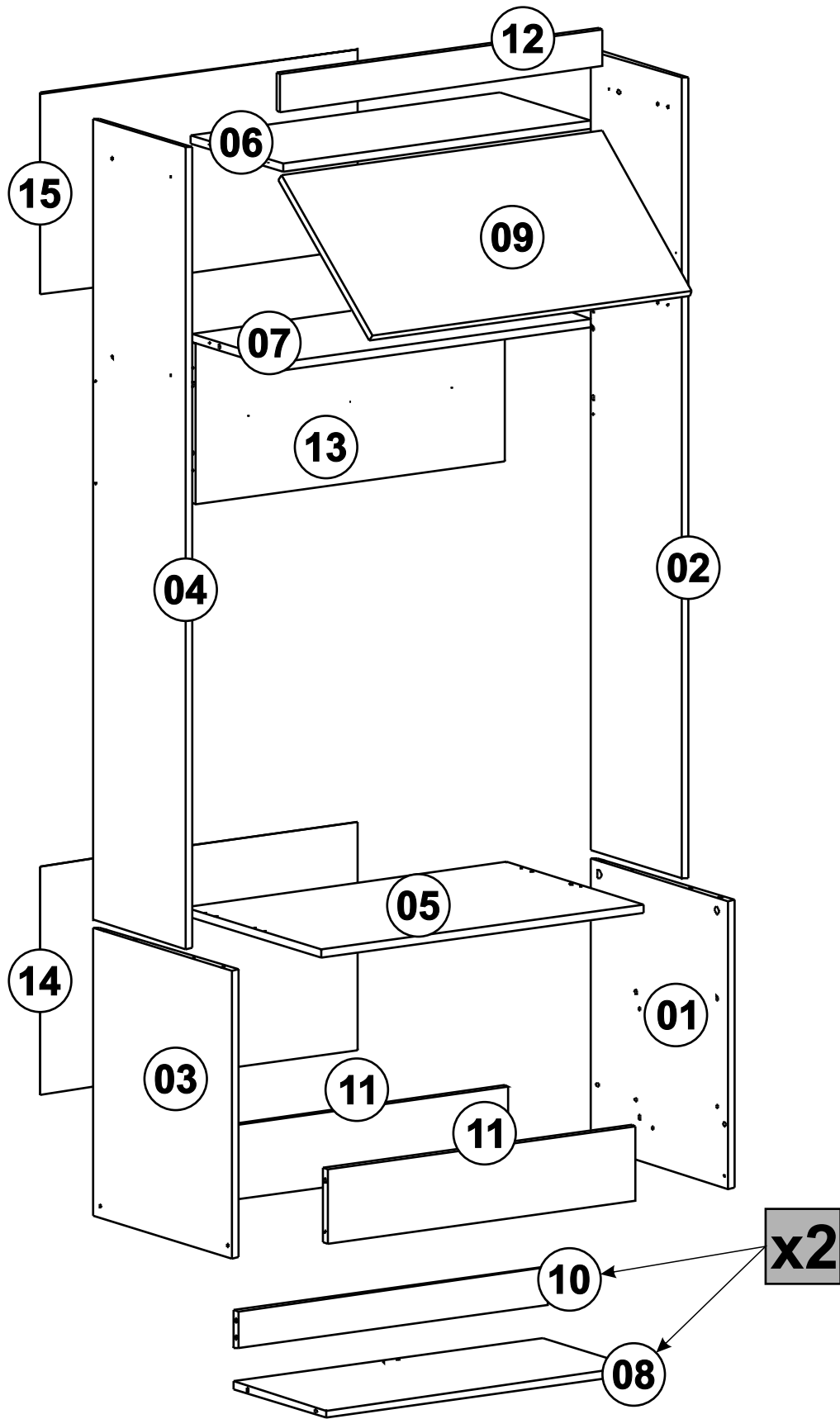









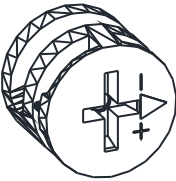

VERSÃO:
01

DATA:
04/07/24

ELABORADO POR:
Michel

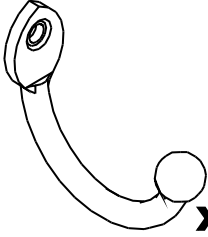
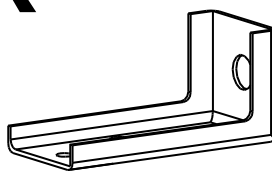
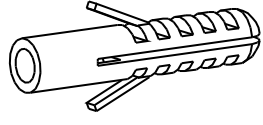
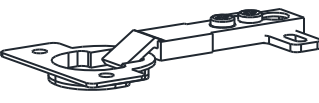
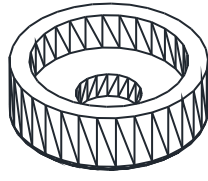
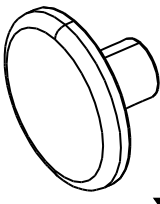
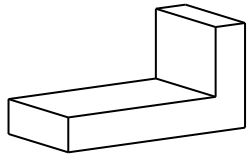
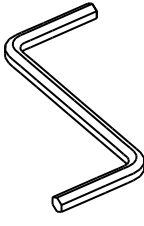
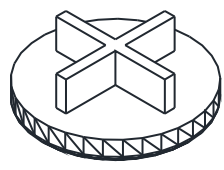
LISTA DE FERRAGEM

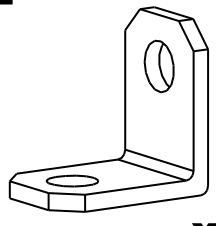
<p>A</p>  <p>x04</p> <p>Tambor Minifix 15x12mm</p>	<p>B</p>  <p>x04</p> <p>Parafuso Minifix</p>	<p>C</p>  <p>x16</p> <p>Parafuso Est 5,0x50 mm</p>	<p>D</p>  <p>x06</p> <p>Parafuso 4,5x50mm CC</p>
<p>E</p>  <p>x02</p> <p>Parafuso 5x40mm CF</p>	<p>F</p>  <p>x28</p> <p>Parafuso 3,5x14mm CP</p>	<p>G</p>  <p>x42</p> <p>Cavilha 8x30mm</p>	<p>H</p>  <p>x04</p> <p>Prego 12x12</p>
<p>I</p>  <p>x70</p> <p>Prego 10x10</p>	<p>J</p>  <p>x03</p> <p>Cabide Metal</p>	<p>K</p>  <p>x02</p> <p>Suporte Aéreo Reforçado</p>	<p>L</p>  <p>x02</p> <p>Bucha 6x35mm</p>
<p>M</p>  <p>x02</p> <p>Dobradiça Retã Ø35 mm</p>	<p>N</p>  <p>x04</p> <p>Sapata</p>	<p>O</p>  <p>x16</p> <p>Tampa Par. 5,0x50 mm</p>	<p>P</p>  <p>x02</p> <p>Capa Suporte Aéreo</p>
<p>Q</p>  <p>x01</p> <p>Chave Allen Z 3mm</p>	<p>R</p>  <p>x04</p> <p>Tampa de Minifix</p>	<p>S</p>  <p>x01</p> <p>Pistão à Gás 50N</p>	<p>T</p>  <p>x03</p> <p>Chapa "L" 20x20x12mm</p>

OBS.: Para proceder corretamente no manuseio do item (S), seguir as instruções do manual do mesmo.

01

OBS.: Tampo lado inferior.

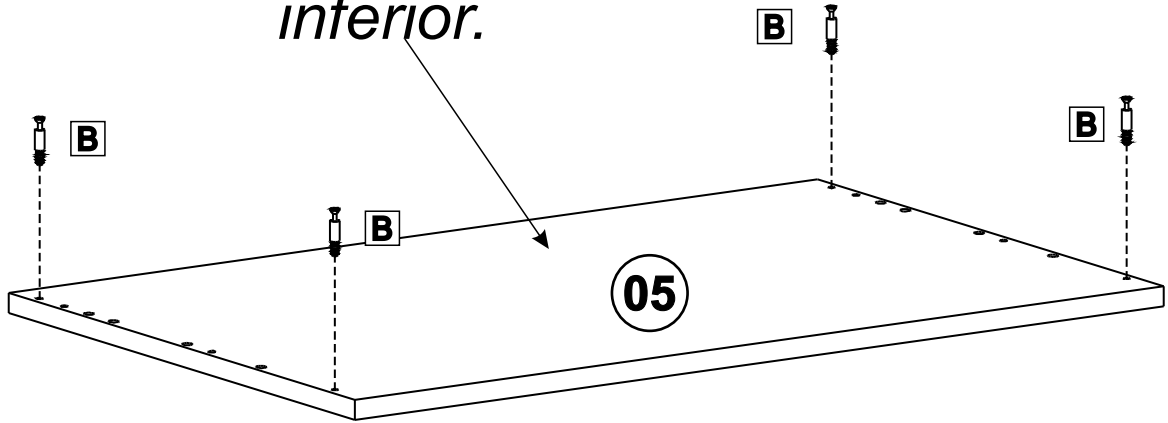

02

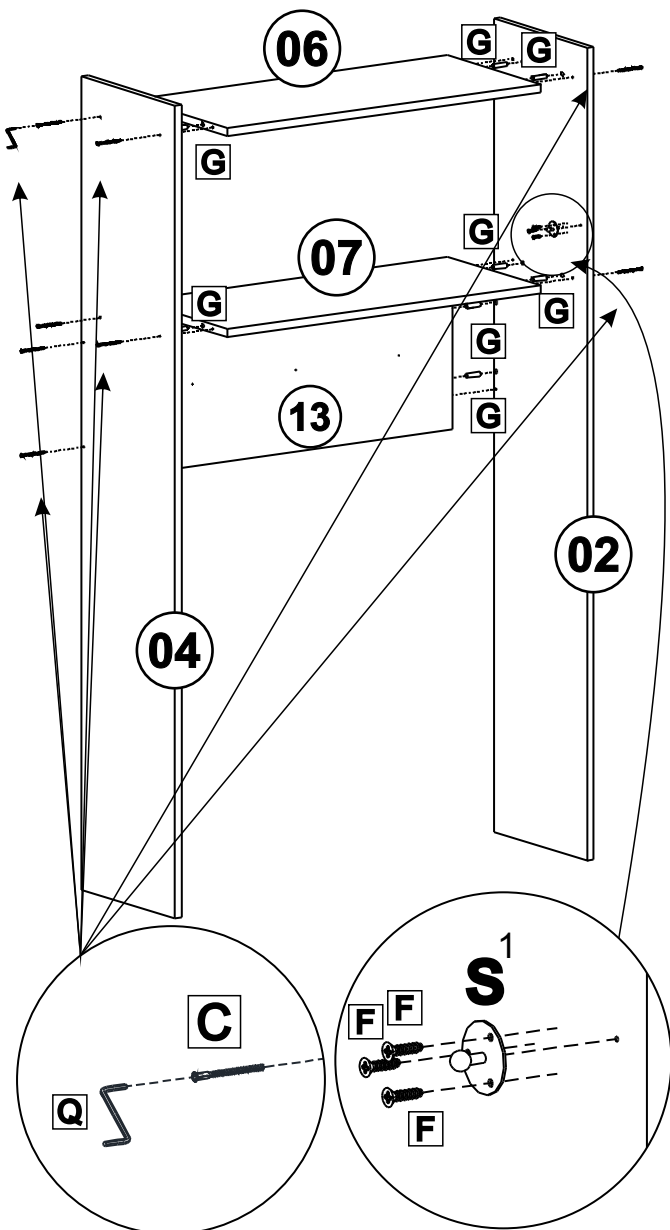

03

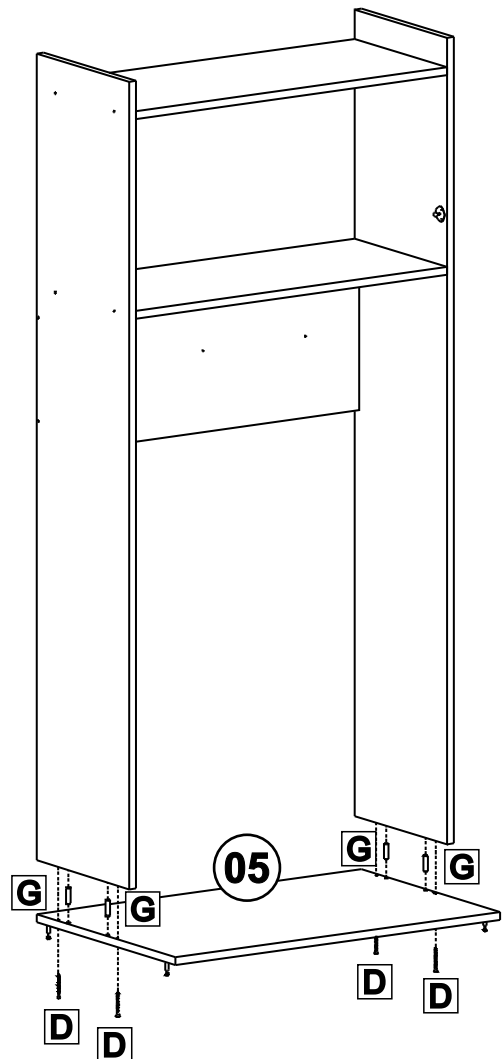

04

x2

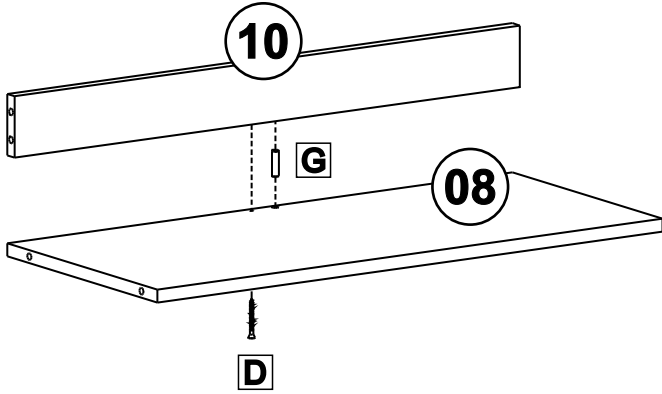

06

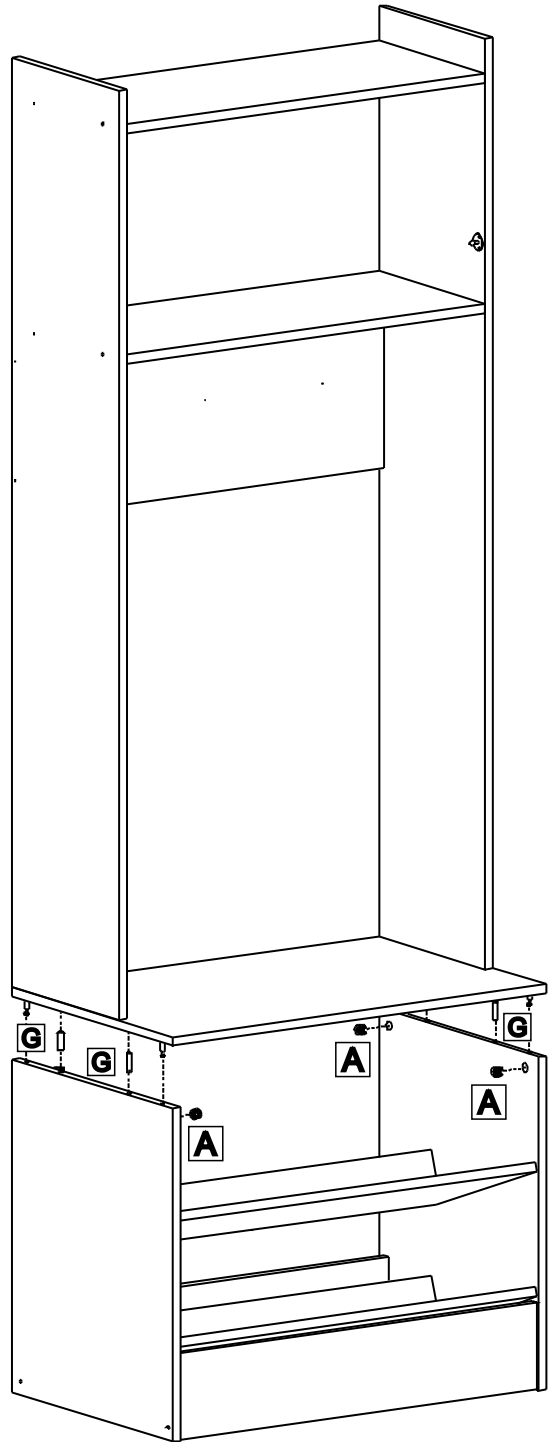

05

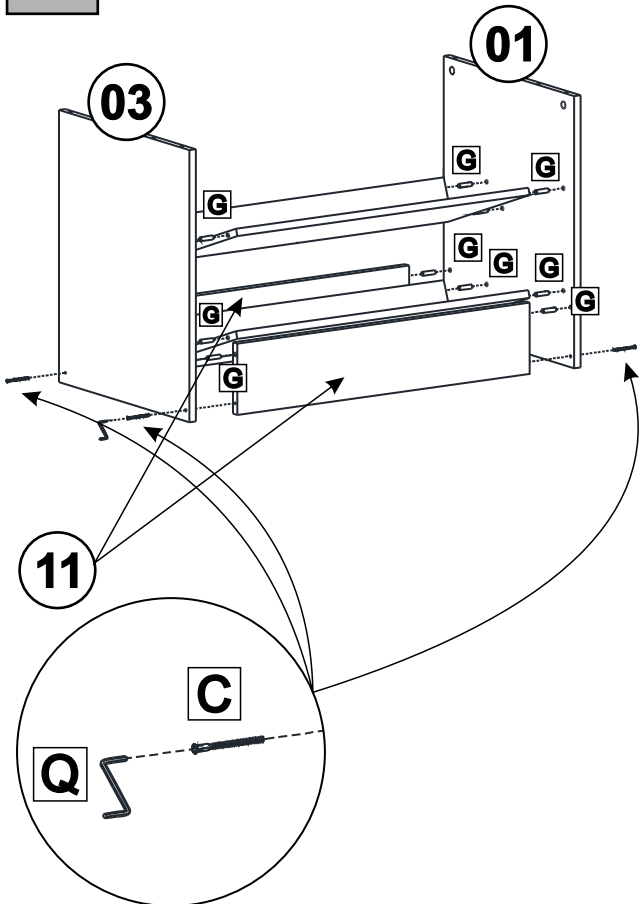

07

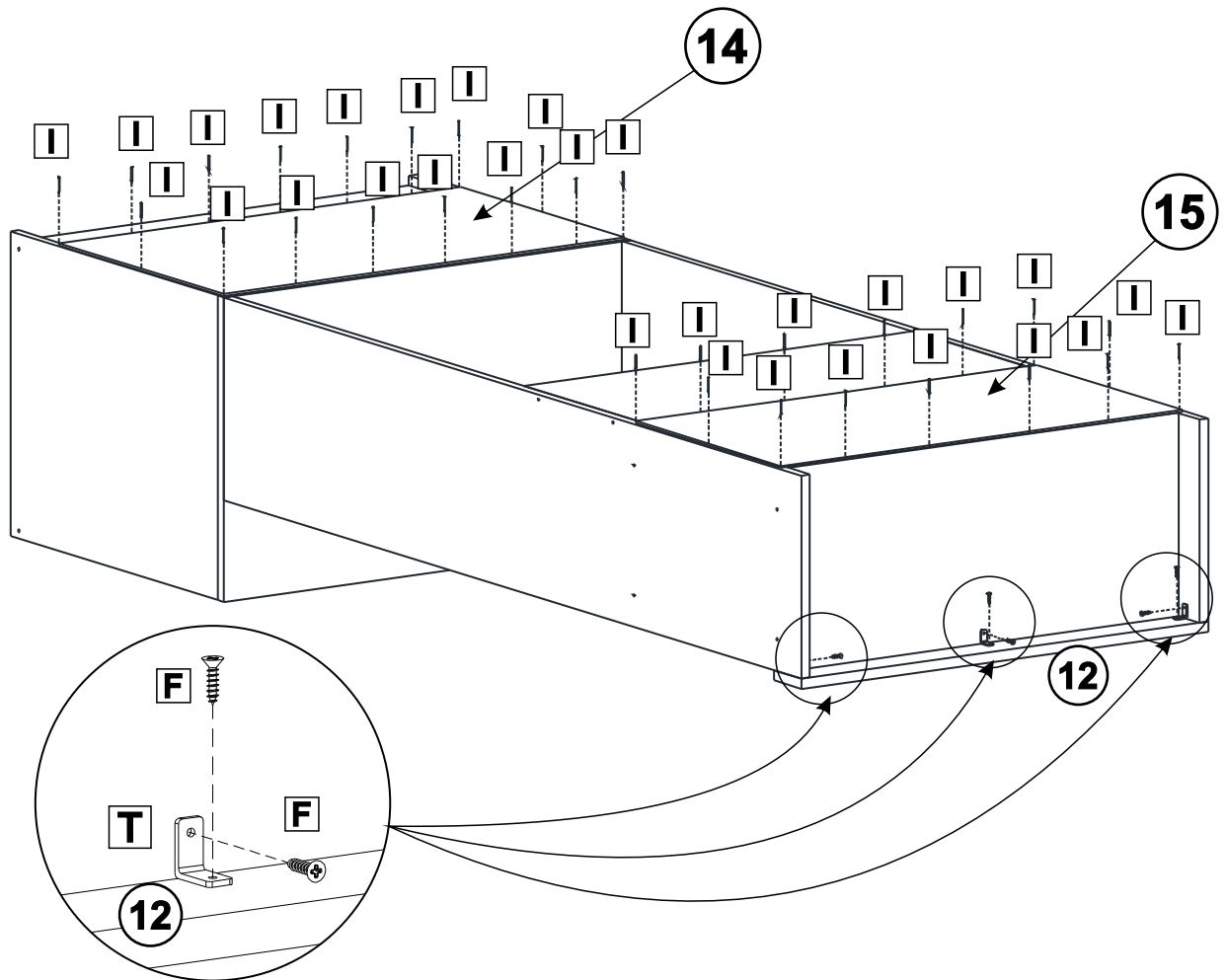

08

FIXAR O MÓVEL NA PAREDE

