

**12** Passo  
Step  
Paso

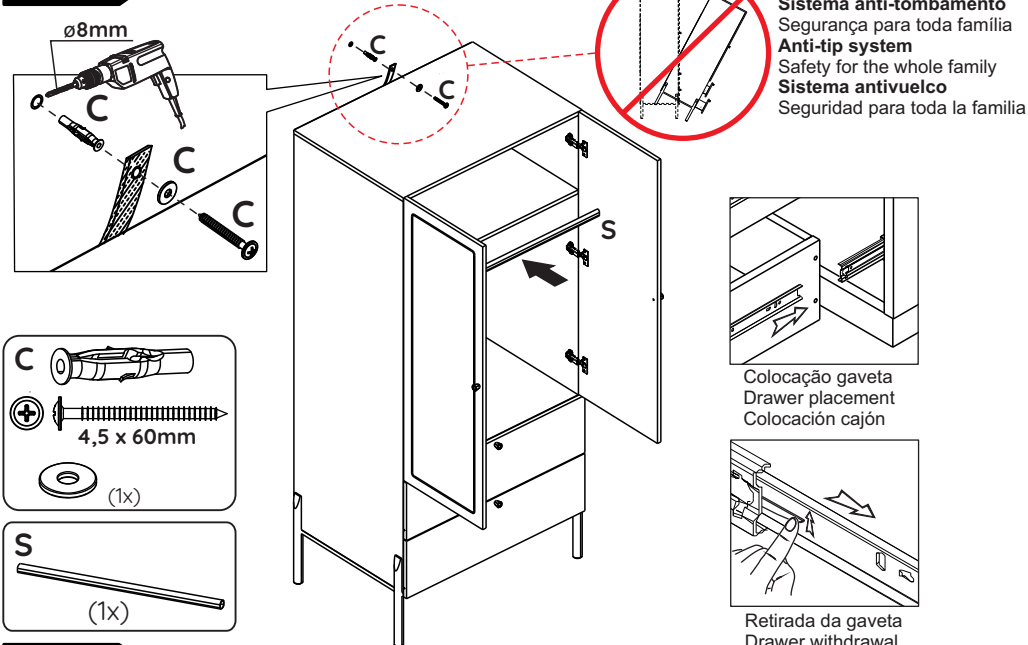

**13** Passo  
Step  
Paso

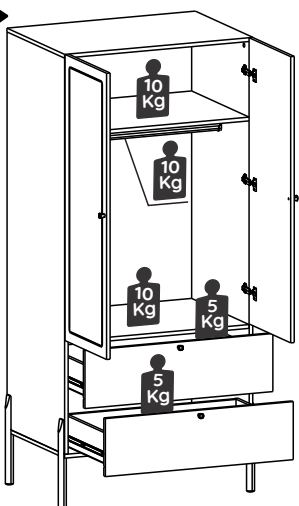

**Dicas de Conservação / Maintenance Tips / Consejos de Mantenimiento**

\*Para limpar ou tirar manchas, utilize uma flanela umedecida em solução de água e álcool, na mesma proporção. Evite exposição ao sol.

\*To clean or remove stains, use a piece of flannel dampened with a water and alcohol solution, in the same proportion. Avoid direct sunlight.

\*Para limpiar o sacar manchas, utilice una flanela humedecida en solución de agua y alcohol, en la misma proporción. Evite la exposición directa al sol.

**INSTRUÇÕES DE MONTAGEM**  
**ASSEMBLY INSTRUCTIONS**  
**INSTRUCCIONES DE MONTAJE**

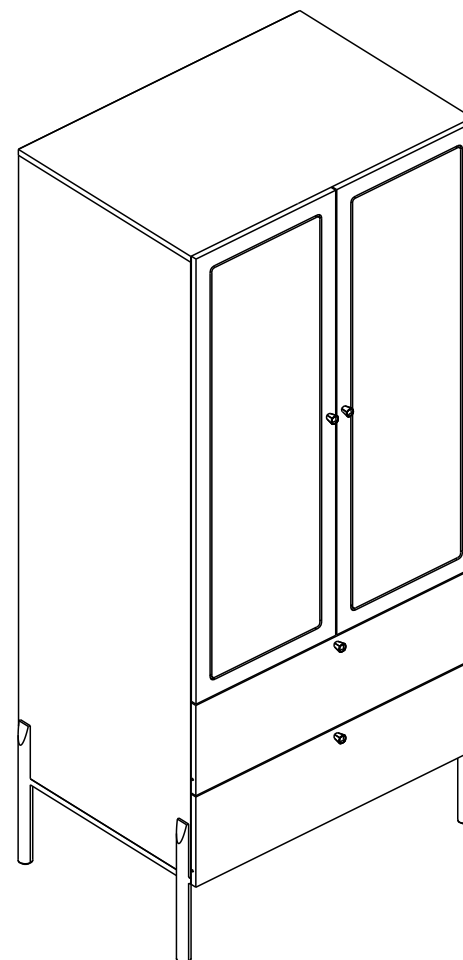









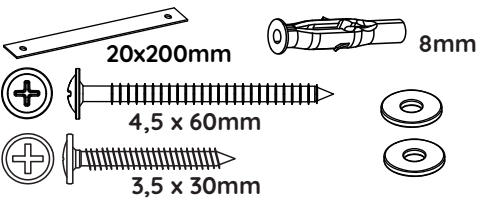

**REF. 28025**

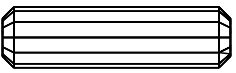
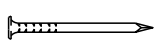
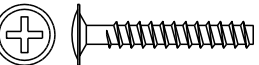

# FERRAGENS / HARDWARE LIST / LISTA DE HERRAJES

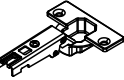
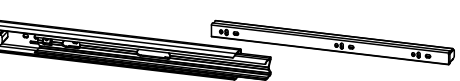
Os desenhos das ferragens são em escala real, então suas dimensões são iguais as das ferragens reais.  
 The hardware drawings are full-scale, so their dimensions are the same as the actual hardware.  
 Los dibujos de los herrajes son la escala real, por lo que sus dimensiones son las mismas que las del herraje real.

ID	IMAGEM DE REFERÊNCIA / IMAGE REFERENCE IMAGEN REFERENCIA	QUANTIDADE # OF PIECES CANTIDAD
A	 4,5 x 45mm	08
B		12
C	 20x200mm 8mm 4,5 x 60mm 3,5 x 30mm	01
D	 3,5 x 30mm	24
E		12
F	 3,5 x 14mm	52
G	 8x30mm	32
H	 8x8	40
I	 3,5 x 25mm	04
J		06
K		06
L	 450mm	02
M	 3mm	12

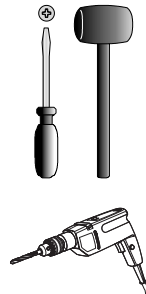

## 10 Passo Step Paso

2x

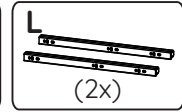
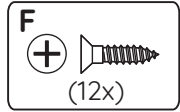
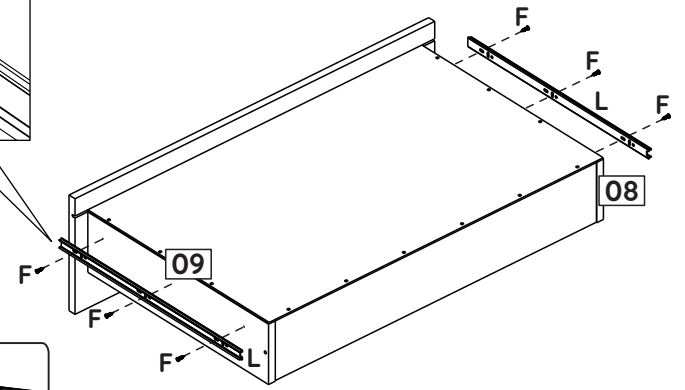
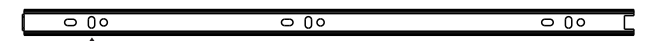
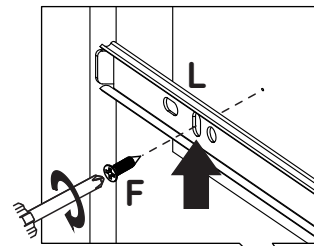

## 11 Passo Step Paso

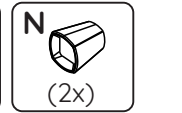
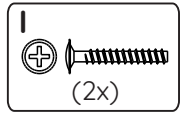
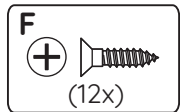
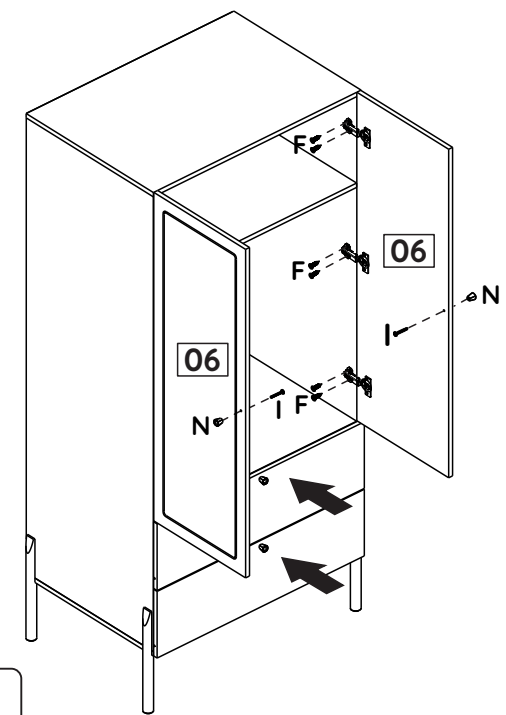

**8** Passo Step Paso

2x

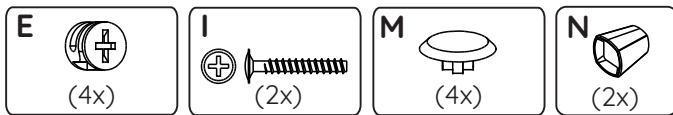
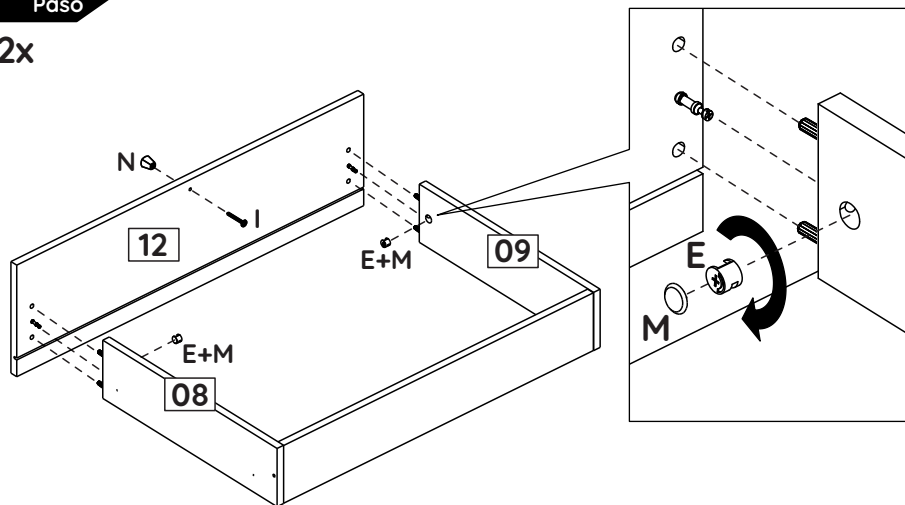

**9** Passo Step Paso

2x

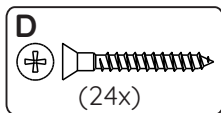
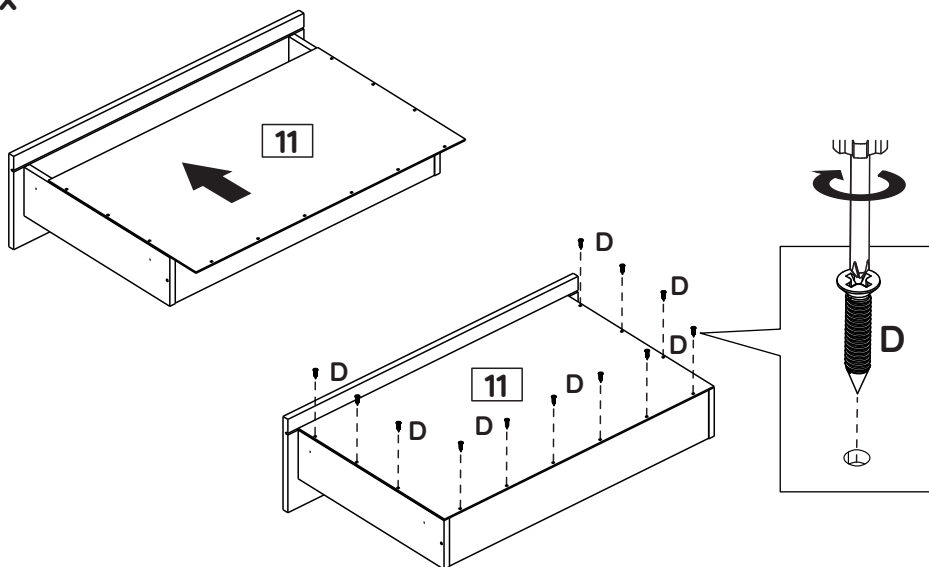

ID	IMAGEM DE REFERÊNCIA / IMAGE REFERENCE IMAGEN REFERENCIA	QUANTIDADE # OF PIECES CANTIDAD
N		04
P	4,5x25mm	12
Q		02
R		04
S	760mm	01
T	820mm	01



**ATENÇÃO!!!**  
 Não arrastar o produto montado.  
 O deslocamento deve ser feito por 2 pessoas erguendo o produto completo do chão.  
**ATTENTION!!!**  
 Do not drag the assembled product.  
 The displacement must be made by 2 people lifting the complete product from the floor.  
**ATENCIÓN!!!**  
 No arraste el producto ensamblado.  
 El desplazamiento debe ser realizado por 2 personas levantando el producto completo del suelo.

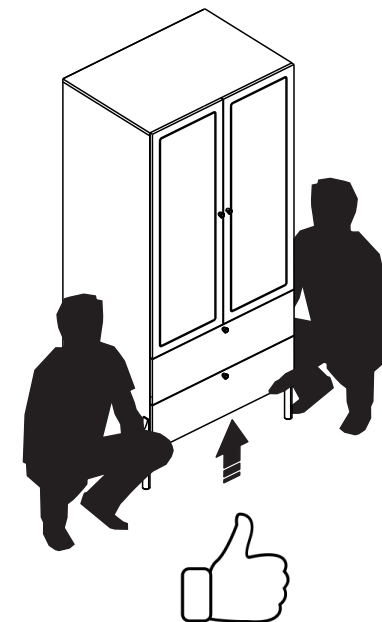

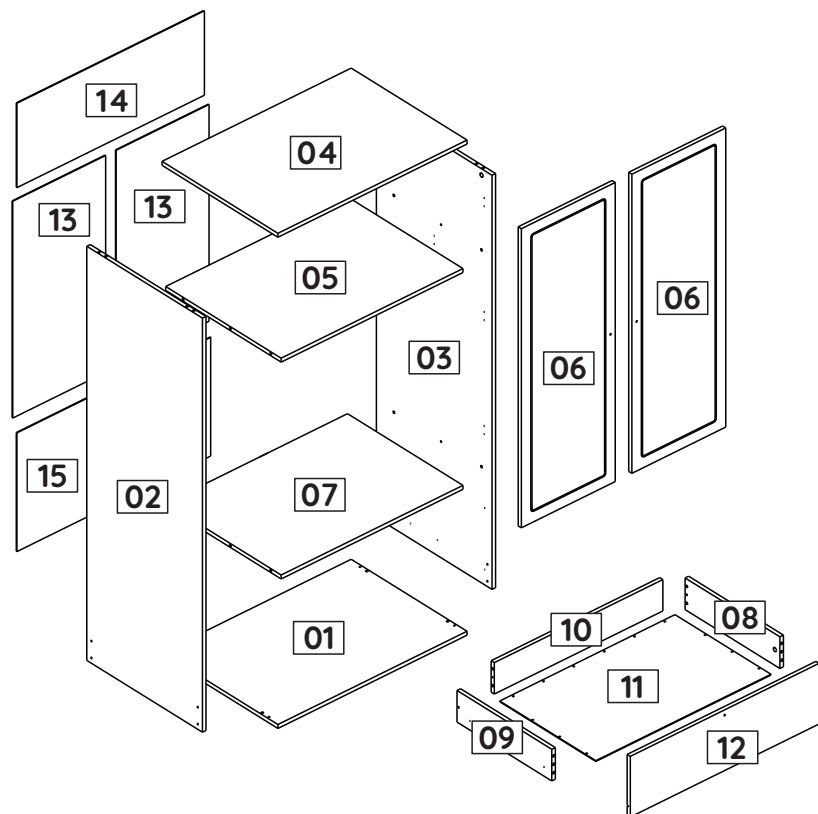

**6** Passo  
Step  
Paso

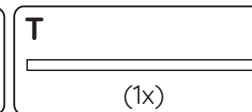
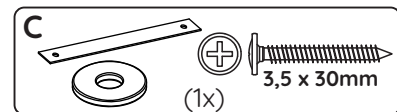
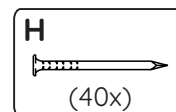
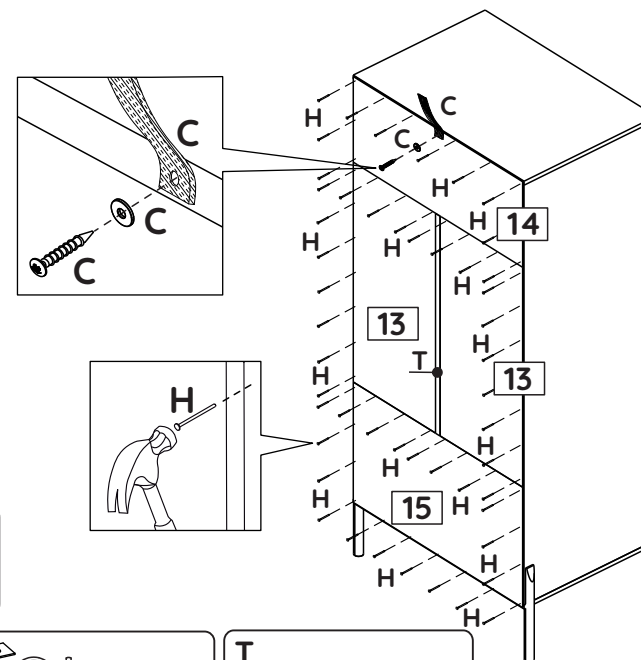

**7** Passo  
Step  
Paso

2x

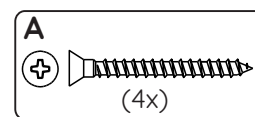
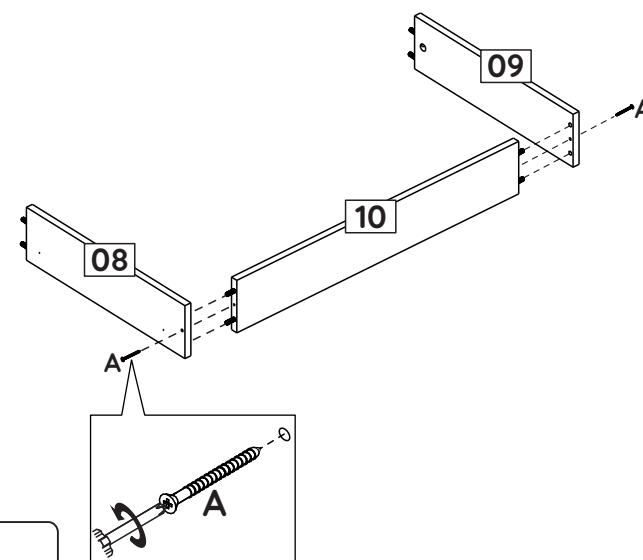

ID	Descrição / Description / Denominación	Quantidade # Of Pieces Cantidad	Dimensão (mm) Dimension (mm) Dimensión (mm)
01	Base/Base/Base	01	800x550x15
02	Lateral esquerda/Left side/Lateral izquierda	01	1570x549x15
03	Lateral direita/Right side/Lateral derecha	01	1570x549x15
04	Tampo/Top/Tapa	01	800x550x15
05	Prateleira/Shelf/Repisa	01	769x548x15
06	Porta/Door/Puerta	02	1134x397x15
07	Tampo interno/Inner top/Tapa interior	01	769x548x15
08	Lateral direita gaveta/Right drawer side/Lateral derecha cajón	02	450x120x15
09	Lateral esquerda gaveta/Left drawer side/Lateral izquierda cajón	02	450x120x15
10	Costa de gaveta/Drawer back/Revés cajón	02	713x119x15
11	Fundo de gaveta/Drawer bottom/Fondo cajón	02	741x456x03
12	Frente de gaveta/Drawer front/Frente cajón	02	798x230x15
13	Costa central/Center back/Revés central	02	822x393x03
14	Costa superior/Upper back/Revés superior	01	793x320x03
15	Costa inferior/Lower back/Revés inferior	01	793x450x03

**5** Passo  
Step  
Paso

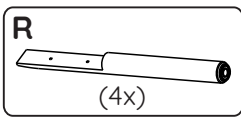
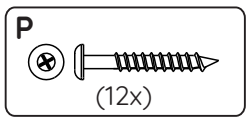
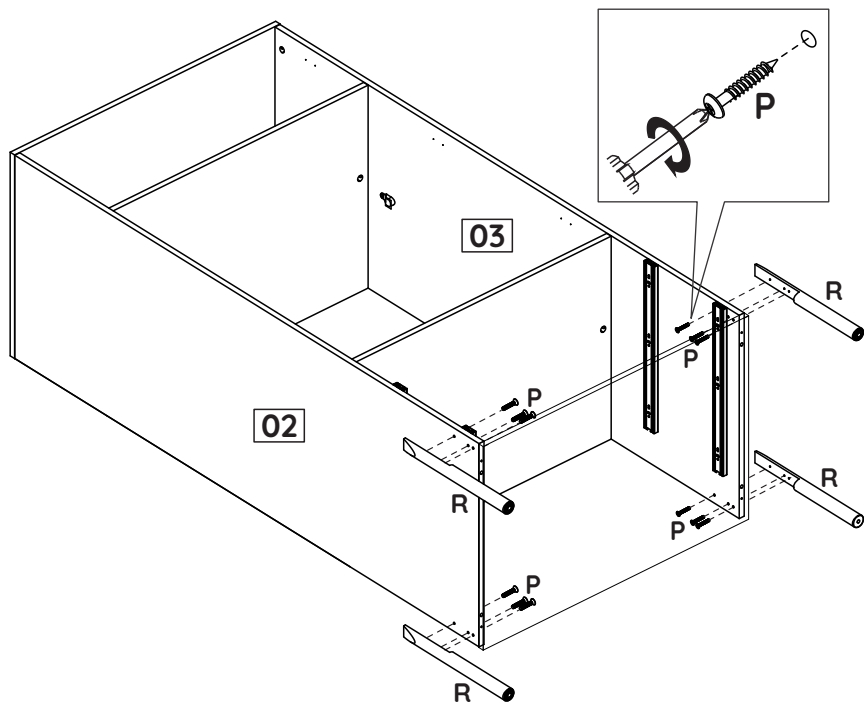



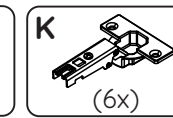
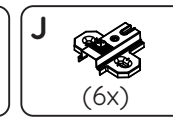
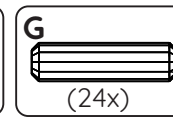
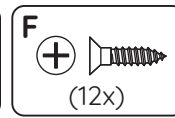
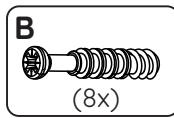
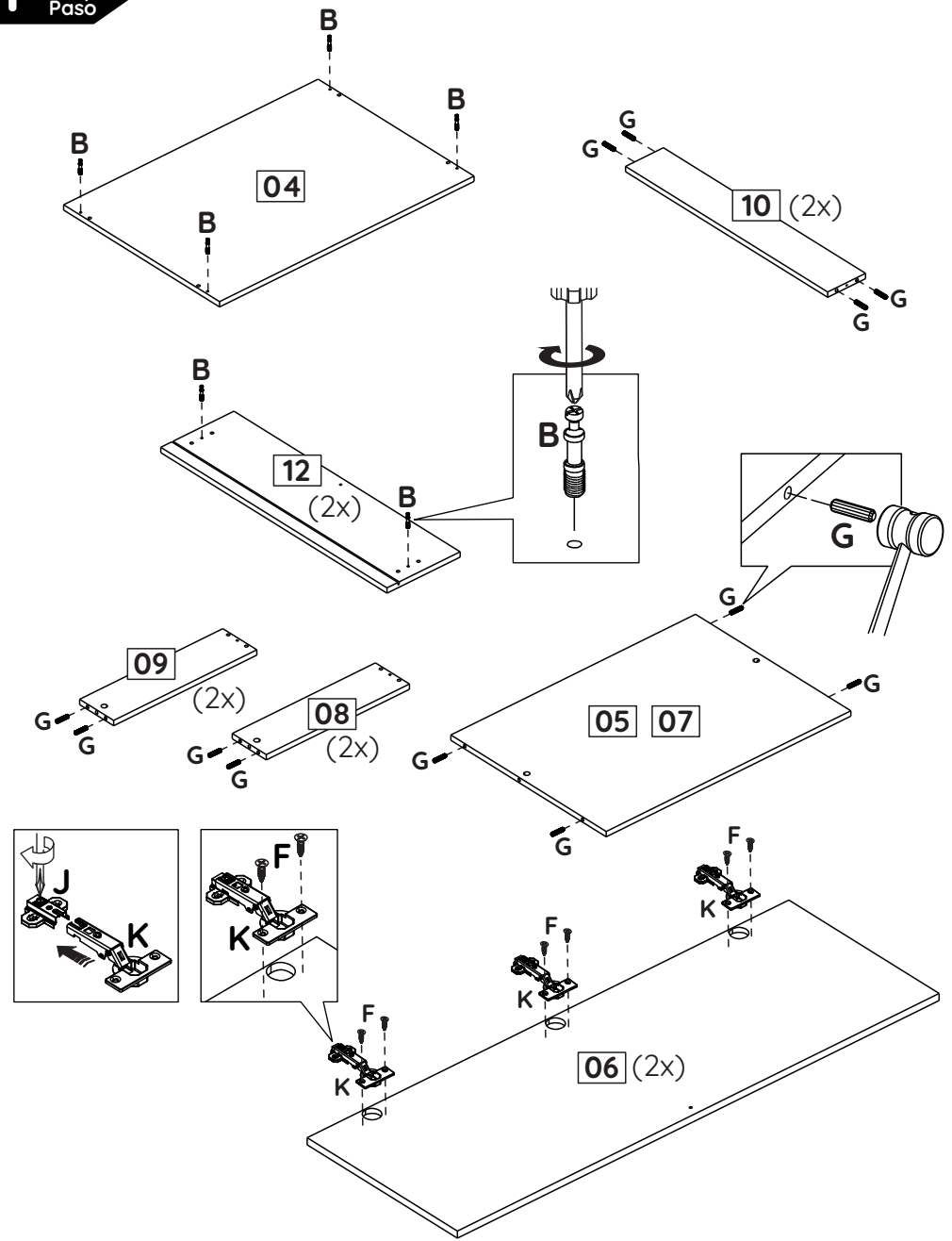

**1** Passo  
Step  
Paso

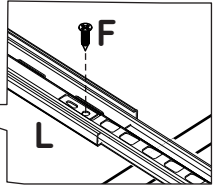
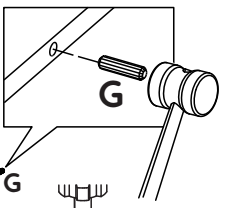
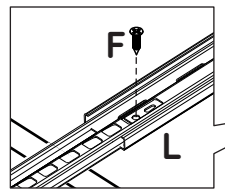
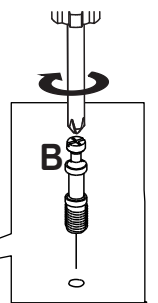
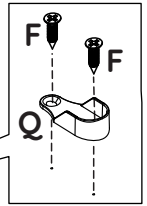
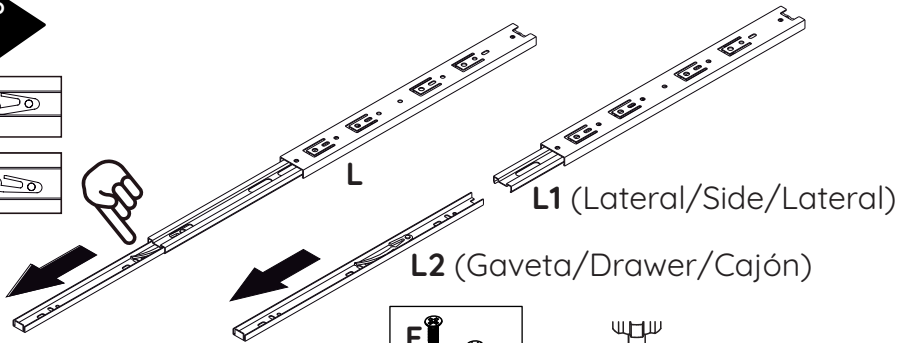
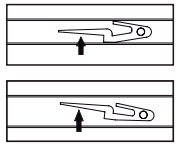

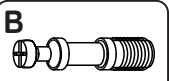
**2** Passo  
Step  
Paso

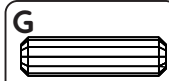

-   
 (4x)
-   
 (16x)
-   
 (8x)
-   
 (2x)
-   
 (2x)

**3** Passo  
Step  
Paso

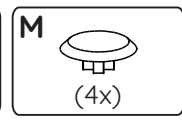
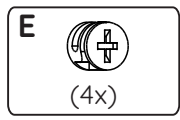
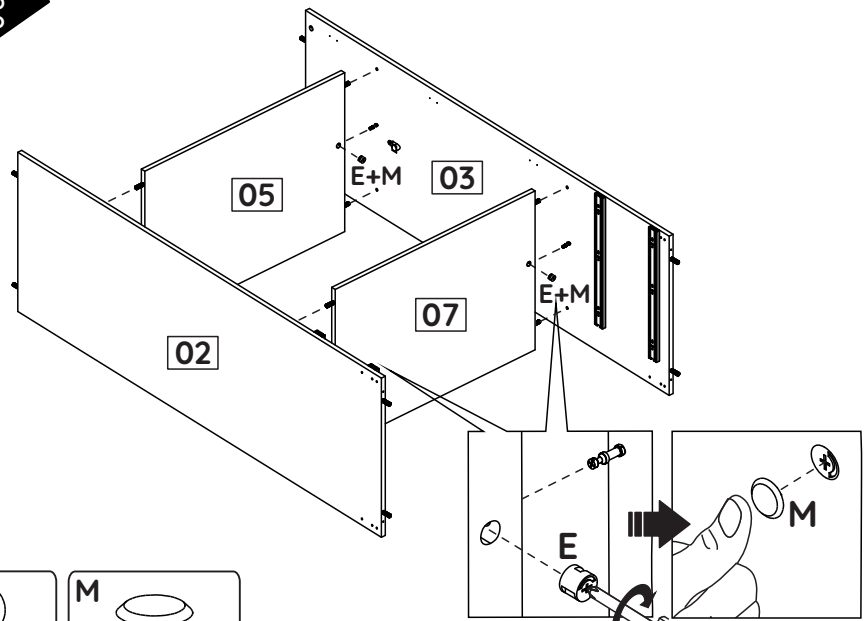

**4** Passo  
Step  
Paso

