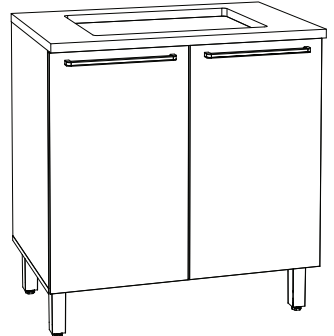
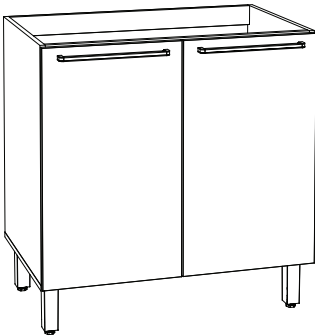
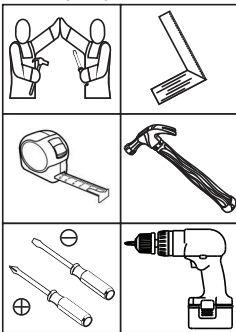

HENNInd. e Com. de Móveis Henn
Mondai - SC - Brasil

☎ +55 49 3674.3500

📧 @moveishenn
www.henn.com.br**INSTRUÇÕES DE
MONTAGEM**INSTRUCCIONES DE MONTAJE
ASSEMBLY INSTRUCTIONS**Balcão 02 Portas 800mm Requite |****Contador 02 Puertas 800mm Requite | Counter 02 Doors 800mm Requite****C639-217 Nature/Areia HP****Opção 01
Opción 01
Option 01****Opção 02
Opción 02
Option 02****Requisitos para montagem
Requisitos para la montaje
Assembly Requirements**

Imagens meramente ilustrativas,
não acompanha o produto.
Imágenes ilustrativas, no incluidas
con el producto.
Illustrative images, not included
with the product.

AVISO

Para limpeza de seu móvel, use uma franela seca ou umedecida, e não utilize produtos químicos que possam danificar seu produto.

SISTEMA DE MONTAGEM

O sistema de montagem dos produtos, funciona de acordo com a ordem crescente dos números indicados no desenho. Ex: 01, 02, 03, 04... até a conclusão da montagem.

ASSISTÊNCIA TÉCNICA

Para solicitação de Assistência Técnica você consumidor deverá entrar em contato com o Lojista a qual você realizou a compra deste produto e solicitar a assistência técnica das peças avariadas. A garantia abrange todas as peças, partes e componentes que eventualmente venham apresentar defeito de fabricação no prazo de 03 (três) meses, contando a partir da entrega do produto ao consumidor, mediante nota fiscal de compra. Se houver qualquer alteração na estrutura do produto ou ocorrer defeito por negligência do montador/consumidor em relação a instrução de montagem e manuseio, não será fornecido assistência técnica gratuita.

ADVERTENCIA

Para limpieza de su móvil, use una franela seca o húmeda, y no utilice productos químicos que puedan dañar su producto.

SISTEMA DE MONTAJE

El sistema de montaje de los productos funciona de acuerdo con el orden creciente de los números indicados en el dibujo. Ej.: 01, 02, 03, 04... hasta la conclusión del montaje.

ASSISTÊNCIA TÉCNICA

Para solicitar Asistencia Técnica, el consumidor debe comunicarse con el Comercio que usted realizó la compra de este producto y solicita asistencia técnica para las partes dañadas. La garantía cubre todas las partes, piezas y componentes que eventualmente puedan presentar defecto de fabricación en el plazo de 03 (tres) meses, contados a partir de la entrega del producto al consumidor, mediante factura de compra. Si se produce algún cambio en la estructura del producto o se produce un defecto por negligencia del montador/consumidor en relación con las instrucciones de montaje y manipulación, no se prestatá asistencia técnica gratuita.

NOTICE

To clean your furniture, use a dry or wet cloth, and do not use chemicals that may damage your product.

ASSEMBLY SYSTEM

The products' assembly system works according to the increasing order of the indicated numbers. For example: 01, 02, 03, 04 ... to the end of the assembly.

TECHNICAL ASSISTANCE

To request Technical Assistance, the consumer must contact the retailer from whom you purchased this product and request technical assistance for the damaged parts. The warranty covers all parts, parts and components that may eventually present a manufacturing defect within a period of 03 (three) months, counting from the delivery of the product to the consumer, by means of a purchase invoice. If there is any change in the structure of the product or defect occurs due to negligence of the assembler/consumer in relation to the assembly and handling instruction, free technical assistance will not be provided.

ACESSÓRIOS | ACCESORIOS | ACCESSORIES

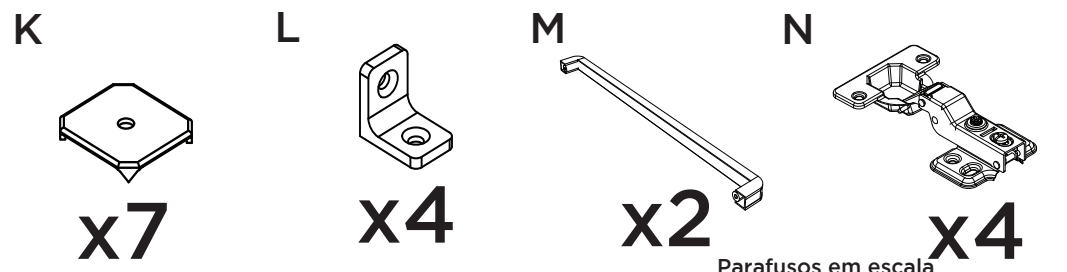
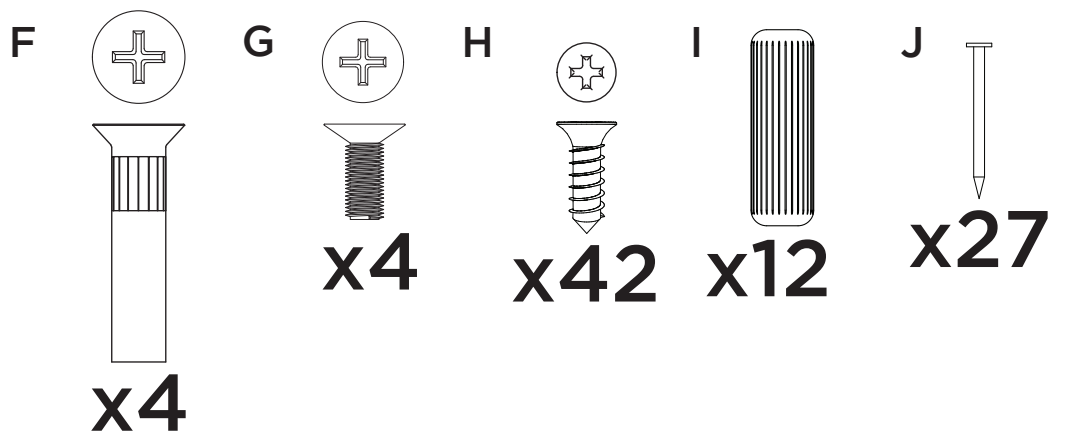
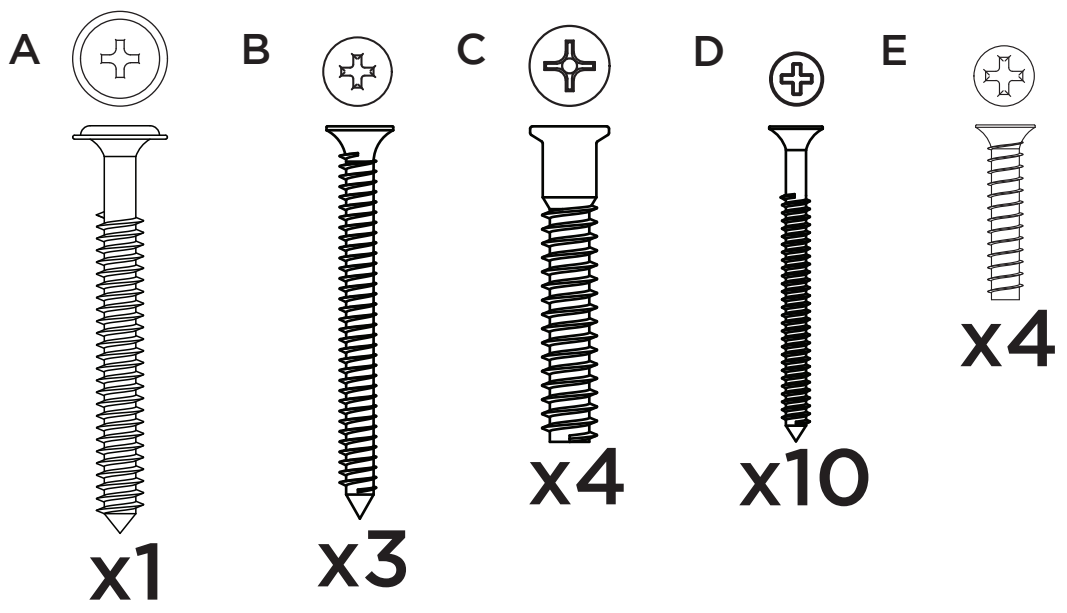

Parafusos em escala
Tornillos escalados
Scaled screws **1:1**

ACESSÓRIOS | ACCESORIOS | ACCESSORIES

O

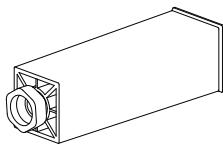

x4

P

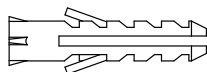

x1

Q

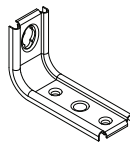

x1

R

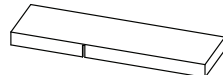

x1

S

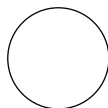

x14

T

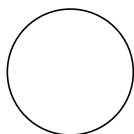

x4

U

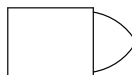

x3

V

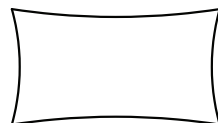

x1



Os parafusos (F/G) devem ser usados somente quando este módulo for acoplado a outro módulo componível Henn.



Los tornillos (F/G) se debe utilizar sólo cuando el módulo está conectado a otro módulo componible Henn.



Screws (F/G) are to be used only when this module is mated to another Henn buildable module.

LISTA DE PEÇAS | LISTA DE PIEZAS | LIST OF PIECES

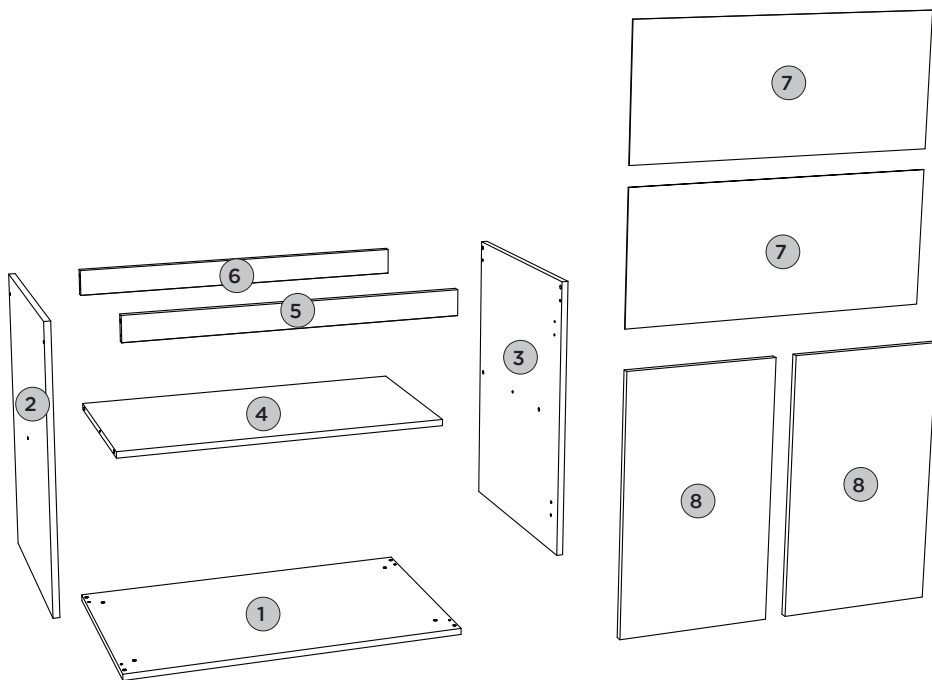





Item	Caixa Caja Box	Qtd Ctd Qty	Descrição Descripción Description	Dimensões (mm) Dimensiones (mm) Dimensions (mm)		
				Comprimento Largo Length	Largura Ancho Width	Espessura Grosor Thickness
1	1/1	01	BASE BASE BASE	800	490	15
2	1/1	01	LATERAL ESQUERDA LATERAL IZQUIERDA LEFT SIDE	660	490	15
3	1/1	01	LATERAL DIREITA LATERAL DERECHA RIGHT SIDE	660	490	15
4	1/1	01	PRATELEIRA ESTANTE SHELF	768	400	15
5	1/1	01	TRAVESSA FRONTAL TRAVESAÑO FRONTAL FRONT CROSSBAR	768	60	15
6	1/1	01	TRAVESSA TRASEIRA TRAVESAÑO TRASERO REAR BUMPER	768	60	15
7	1/1	02	FUNDO FONDO BOTTOM	792	335	3
8	1/1	02	PORTA PUERTA DOOR	665	396	15

PEÇAS REQUERIDAS

1	BASE	x1
2	LATERAL ESQUERDA	x1
3	LATERAL DIREITA	x1
4	PRATELEIRA	x1
5	TRAVESSA FRONTAL	x1
6	TRAVESSA TRASEIRA	x1

ACESSÓRIOS REQUERIDOS

C		04
I		12
O		04
V		

FERRAMENTAS NECESSÁRIAS

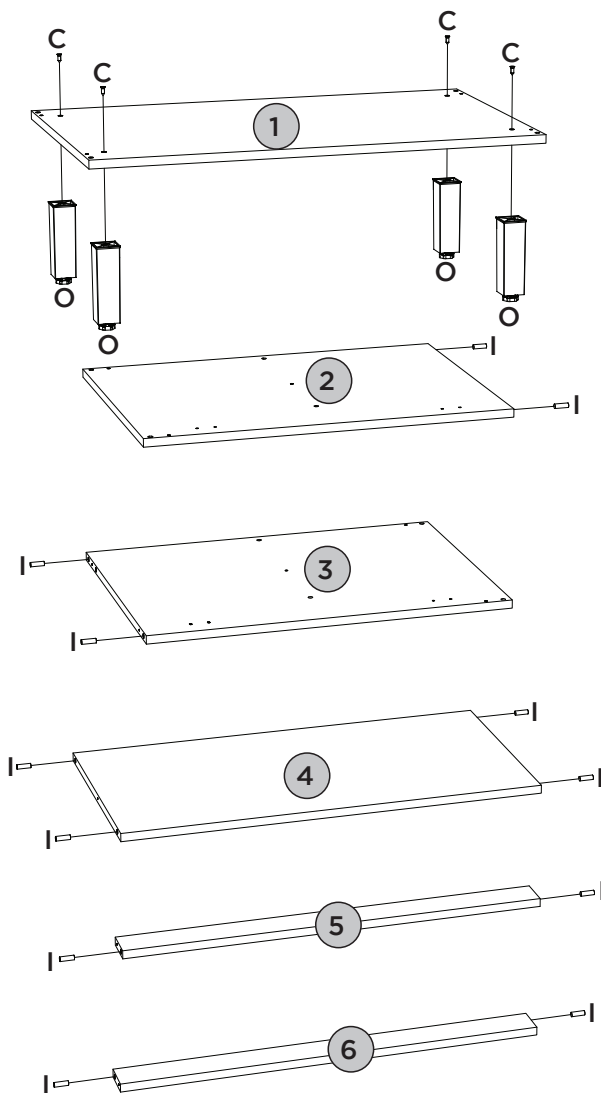
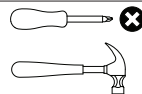

Utilizar o sachê de cola (V) em todas as cavilhas (I) do produto.

Con el pegamento sobre (V) en todos los pernos (I) producto.

Use the glue sachet (V) on all the pegs (I) of the product.



PASSO 2

ITM/C639-

PEÇAS REQUERIDAS

1	BASE	x1
2	LATERAL ESQUERDA	x1
3	LATERAL DIREITA	x1
4	PRATELEIRA	x1
5	TRAVESSA FRONTAL	x1
6	TRAVESSA TRASEIRA	x1



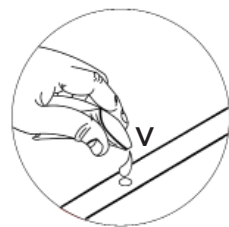
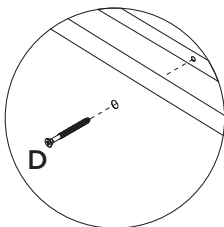
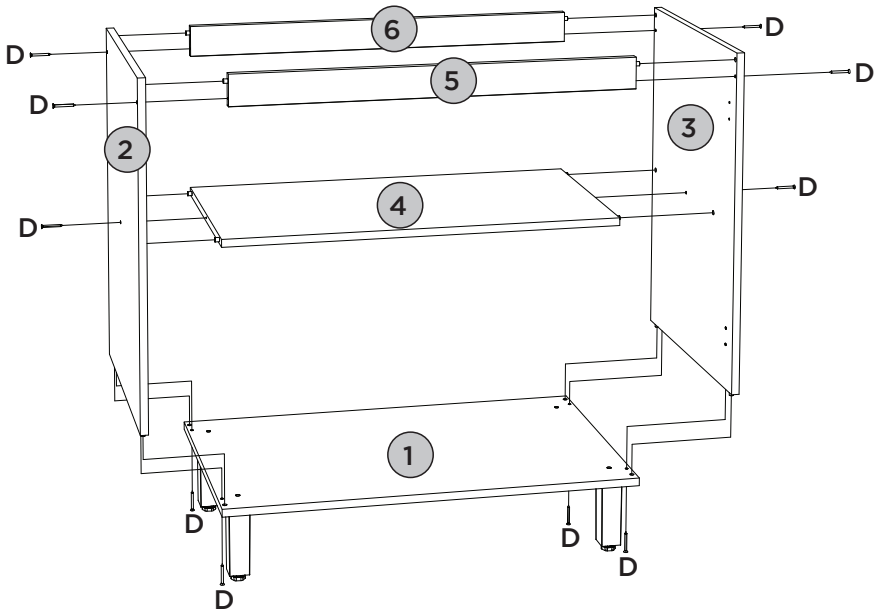
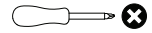

ACESSÓRIOS REQUERIDOS

D			10
V			

FERRAMENTAS NECESSÁRIAS



ACESSÓRIOS REQUERIDOS

B			03
H			08
L			04

FERRAMENTAS NECESSÁRIAS

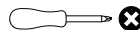

Esse tampo é opcional e é vendido separadamente (C904-128).

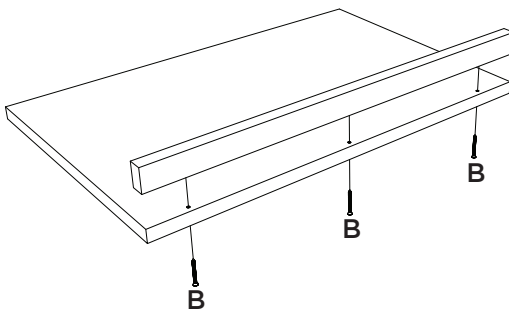

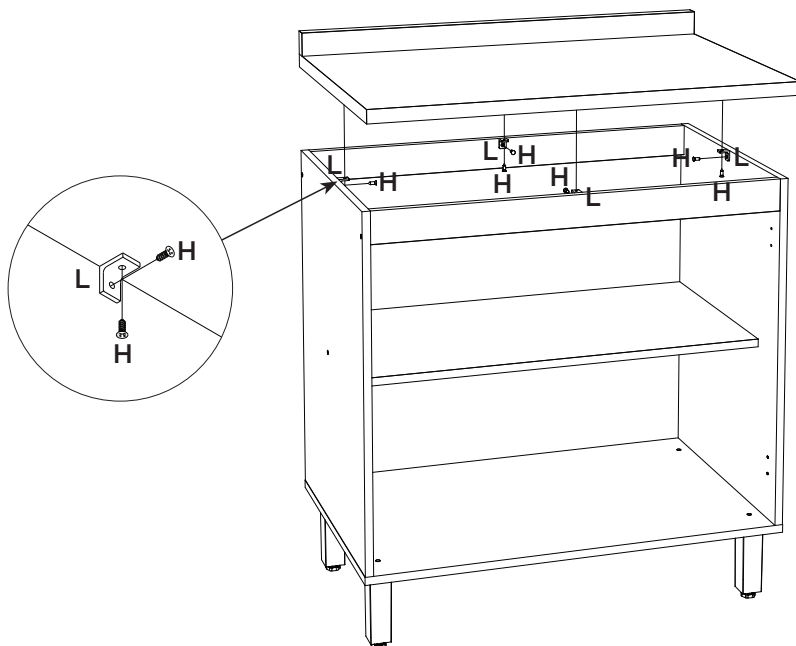

Esta vez es opcional y se vende por separado (C904-128).

This top is optional and is sold separately (C904-128).



ACESSÓRIOS REQUERIDOS

H			08
L			04

FERRAMENTAS NECESSÁRIAS

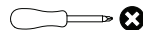

Esse tampo é opcional e é vendido separadamente (C908-128).

Esta vez es opcional y se vende por separado (C908-128).

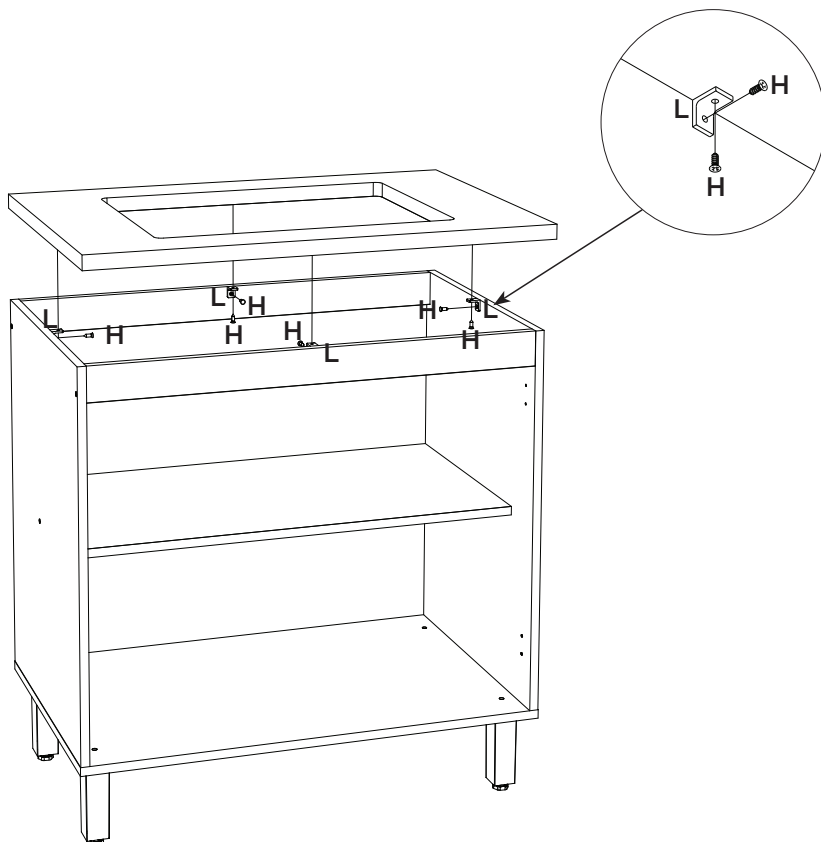

This top is optional and is sold separately (C908-128).



PEÇAS REQUERIDAS

7	FUNDO	x2
---	-------	----

ACESSÓRIOS REQUERIDOS

H		08
J		27
K		07

FERRAMENTAS NECESSÁRIAS

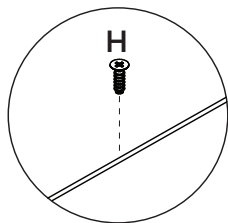
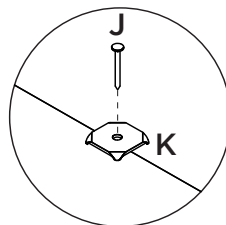
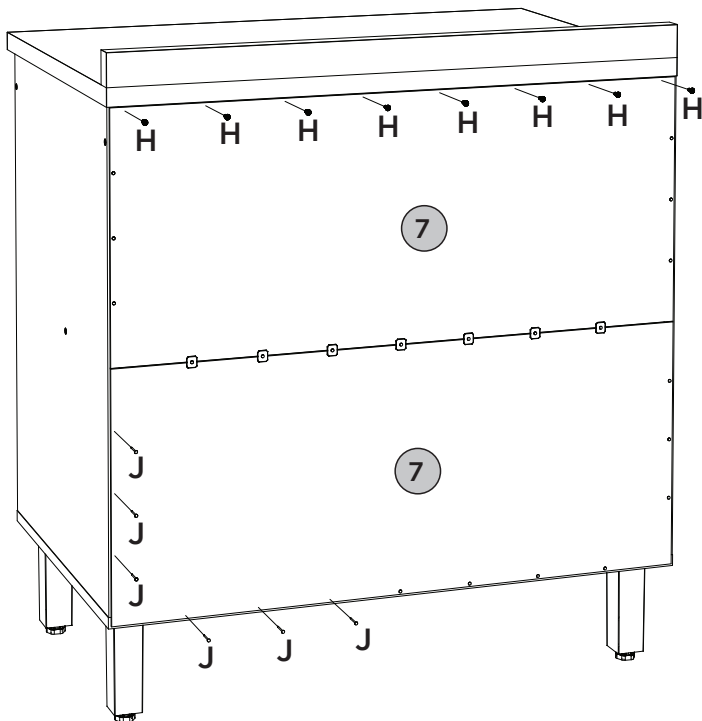
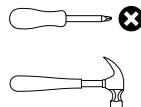

Fixar os pregos a uma distância de 100mm de um para outro.



Fijar las uñas a un distancia de 100mm uno a otro.

Fix the nails at a distance of 100mm from one to the other

PASSO 6**PEÇAS REQUERIDAS**

8	PORTA	x2
---	-------	----

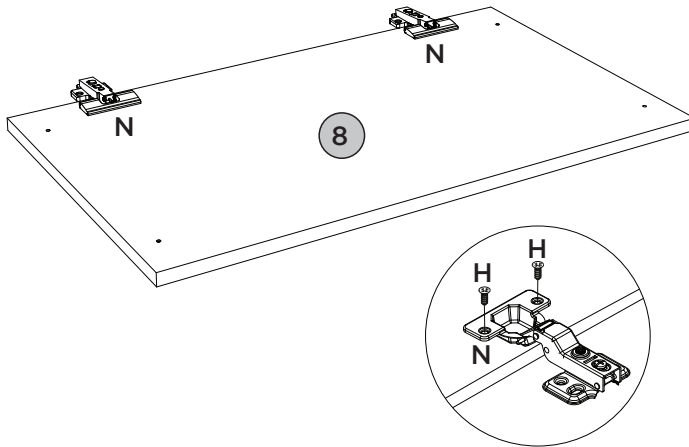
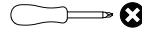

ACESSÓRIOS REQUERIDOS

H		08
N		04

FERRAMENTAS NECESSÁRIAS**PASSO 7****PEÇAS REQUERIDAS**

8	PORTA	x2
---	-------	----

ACESSÓRIOS REQUERIDOS

E		04
H		16
M		02







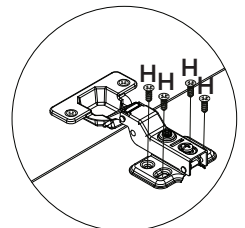
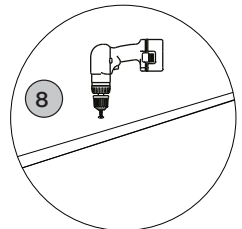
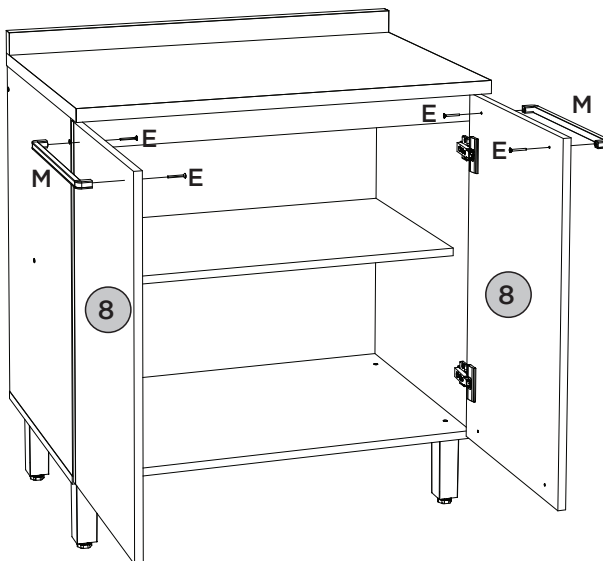

FERRAMENTAS NECESSÁRIAS

Para porta (8): Defina para o modo de perfuração.

Faça a furação passante para fixar o puxador (M).

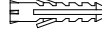

ACESSÓRIOS REQUERIDOS

A		01	R		01
H		02	S		14
P		01	T		04
Q		01	U		03

FERRAMENTAS NECESSÁRIAS



OU



Para parede: Ajustar no modo perfuração

Pesos máximos recomendados com carga distribuída
Peso máximo recomendado con la carga distribuida
Recommended maximum weight with distributed load.

PERFECT CORRECTION
 CORRECCIÓN PERFECTA

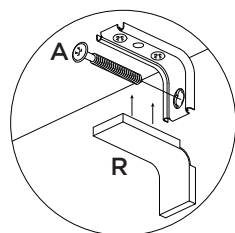
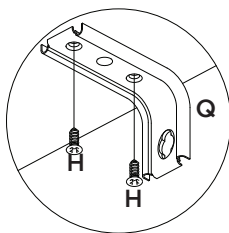
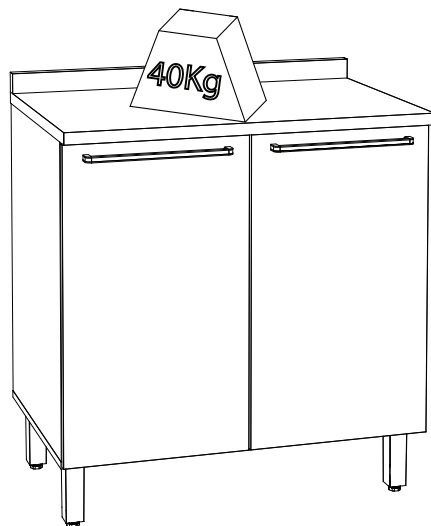
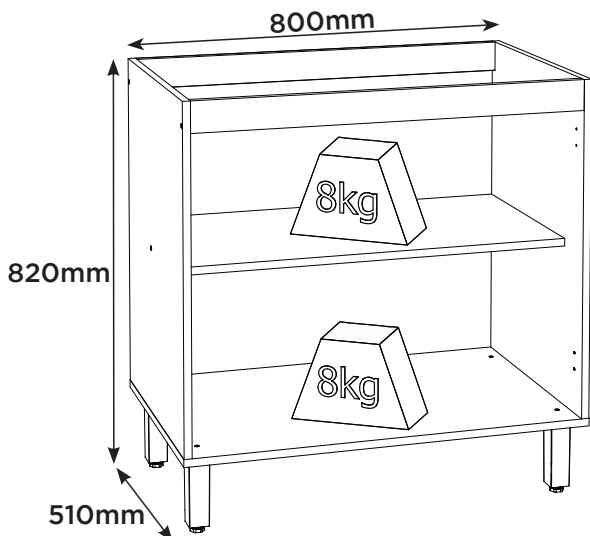
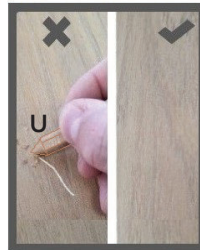

RECOMENDAÇÃO

Para fixar o móvel na parede usar o suporte de fixação (Q), o parafuso 4,0x14mm CHT (H), a Bucha 8mm (P) e o parafuso 5,0x50mm FLA (A).

RECOMENDACIÓN

Para conectar el móvil a la pared con el soporte (Q), tornillo 4,0x14mm CHT (H), el casquillo de 8 mm (P) y el 5,0 x50mm tornillo FLA (A).

RECOMMENDATION

To fix the furniture to the wall use the fixing bracket (Q), the 4,0x14mm CHT (H) screw, the 8mm bushing (P) and the 5.0x50mm FLA screw (A).

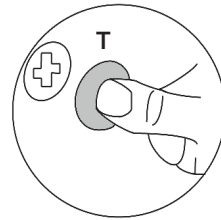
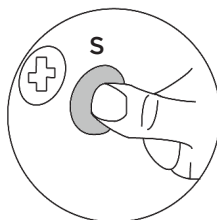

Produto Concluído
Producto terminado
Finished Product

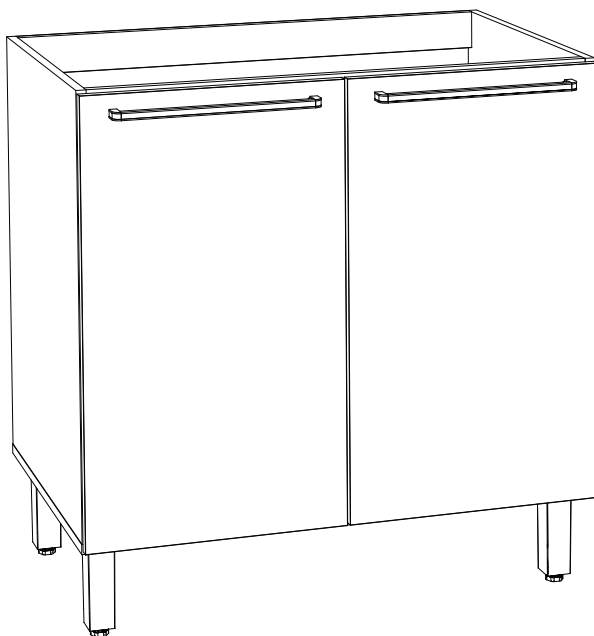

HENNInd. e Com. de Móveis Henn
Mondai - SC - Brasil

☎ +55 49 3674.3500

📧 @moveishenn
www.henn.com.br**INSTRUÇÕES DE
MONTAGEM**INSTRUCCIONES DE MONTAJE
ASSEMBLY INSTRUCTIONS**Balcão 01 Porta 400mm Requite |**
Contador 01 Puerta 400mm Requite | Counter 01 Door 400mm Requite

C638-217 Nature/Areia HP

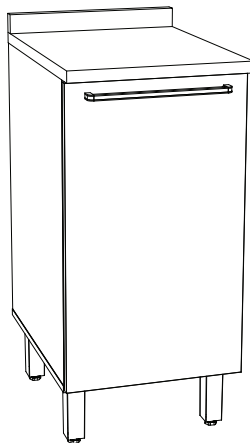
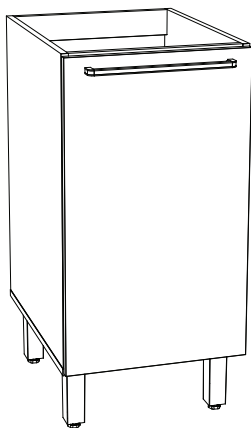
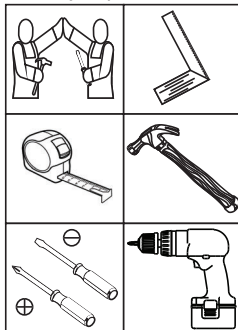
Opção
Opción
Option**Requisitos para montagem**
Requisitos para la montaje
Assembly Requirements

Imagens meramente ilustrativas,
não acompanha o produto.
Imágenes ilustrativas, no incluidas
con el producto.
Illustrative images, not included
with the product.

AVISO

Para limpeza de seu móvel, use uma franela seca ou umedecida, e não utilize produtos químicos que possam danificar seu produto.

SISTEMA DE MONTAGEM

O sistema de montagem dos produtos, funciona de acordo com a ordem crescente dos números indicados no desenho. Ex: 01, 02, 03, 04... até a conclusão da montagem.

ASSISTÊNCIA TÉCNICA

Para solicitação de Assistência Técnica você consumidor deverá entrar em contato com o Lojista o qual você realizou a compra deste produto e solicitar a assistência técnica das peças avariadas. A garantia abrange todas as peças, partes e componentes que eventualmente venham apresentar defeito de fabricação no prazo de 03 (três) meses, contando a partir da entrega do produto ao consumidor, mediante nota fiscal de compra. Se houver qualquer alteração na estrutura do produto ou ocorrer defeito por negligência do montador/consumidor em relação a instrução de montagem e manuseio, não será fornecido assistência técnica gratuita.

ADVERTENCIA

Para limpieza de su móvil, use una franela seca o húmeda, y no utilice productos químicos que puedan dañar su producto.

SISTEMA DE MONTAJE

El sistema de montaje de los productos funciona de acuerdo con el orden creciente de los números indicados en el dibujo. Ej.: 01, 02, 03, 04... hasta la conclusión del montaje.

ASSISTÊNCIA TÉCNICA

Para solicitar Assistência Técnica, o consumidor deve comunicar-se com o Comercio que usted realizou a compra de este produto y solicita asistencia técnica para las partes dañadas. La garantía cubre todas las partes, piezas y componentes que eventualmente puedan presentar defecto de fabricación en el plazo de 03 (tres) meses, contados a partir de la entrega del producto al consumidor, mediante factura de compra. Si se produce algún cambio en la estructura del producto o se produce un defecto por negligencia del montador/consumidor en relación con las instrucciones de montaje y manipulación, no se prestará asistencia técnica gratuita.

NOTICE

To clean your furniture, use a dry or wet cloth, and do not use chemicals that may damage your product.

ASSEMBLY SYSTEM

The products' assembly system works according to the increasing order of the indicated numbers. For example: 01, 02, 03, 04 ... to the end of the assembly.

TECHNICAL ASSISTANCE

To request Technical Assistance, the consumer must contact the retailer from whom you purchased this product and request technical assistance for the damaged parts. The warranty covers all parts, parts and components that may eventually present a manufacturing defect within a period of 03 (three) months, counting from the delivery of the product to the consumer, by means of a purchase invoice. If there is any change in the structure of the product or defect occurs due to negligence of the assembler/consumer in relation to the assembly and handling instruction, free technical assistance will not be provided.

ACESSÓRIOS | ACCESORIOS | ACCESSORIES

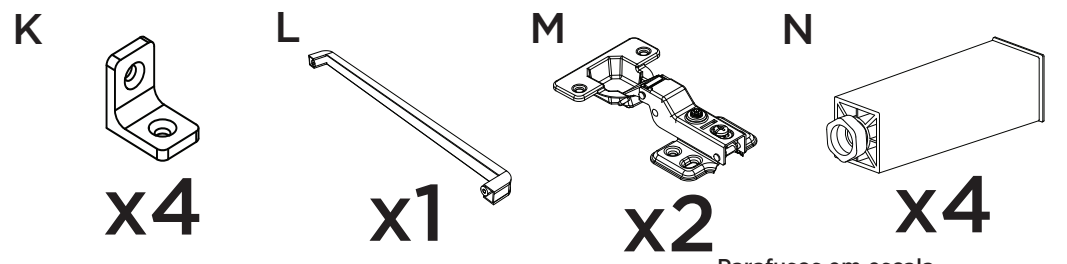
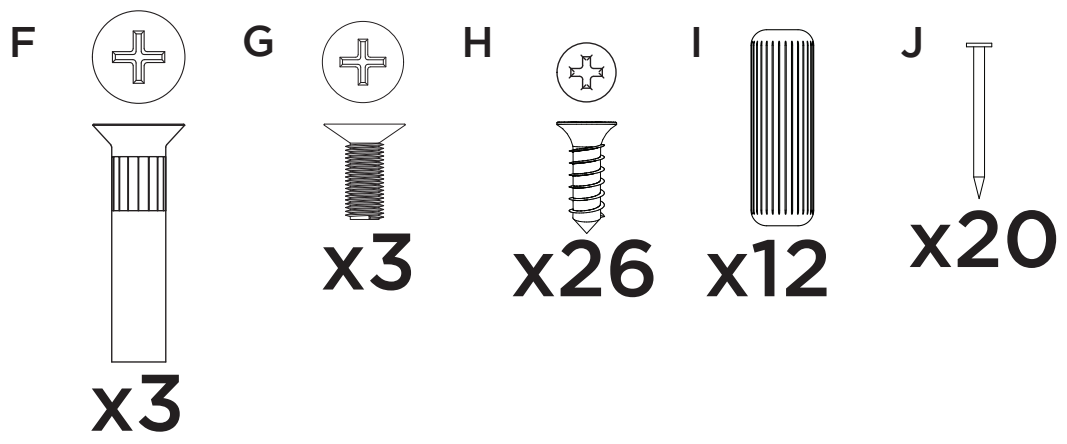
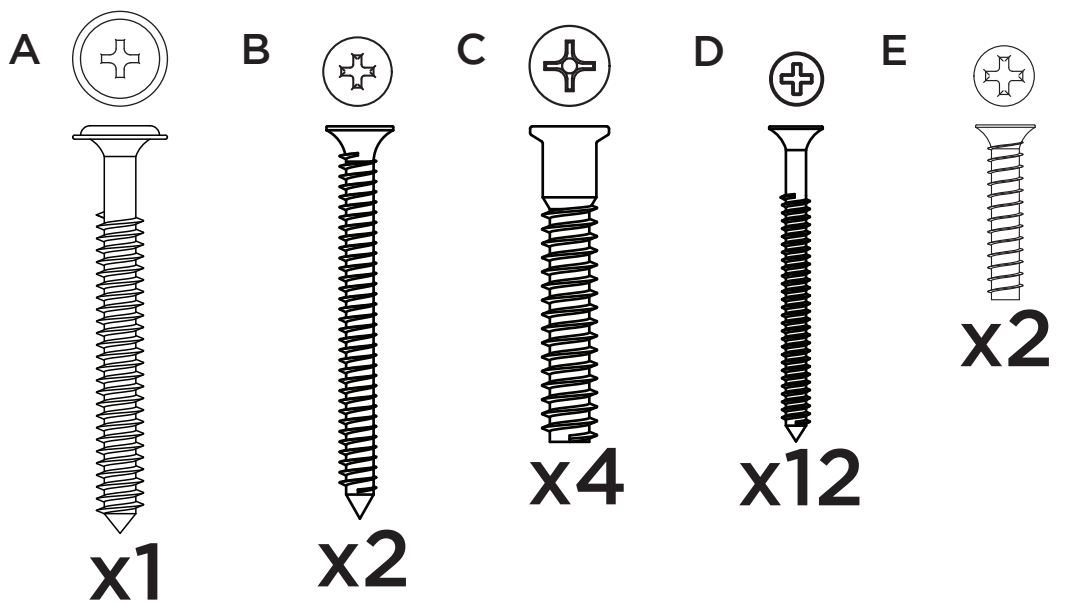

Parafusos em escala
 Tornillos escalados
 Scaled screws **1:1**

ACESSÓRIOS | ACCESORIOS | ACCESSORIES

O

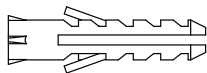

x1

P

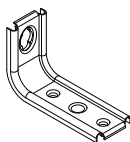

x1

Q

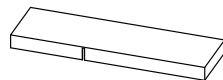

x1

R

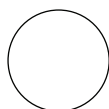

x14

S

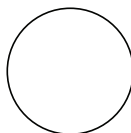

x4

T

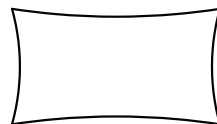

x1



Os parafusos (F/G) devem ser usados somente quando este módulo for acoplado a outro módulo componível Henn.



Los tornillos (F/G) se debe utilizar sólo cuando el módulo está conectado a otro módulo componible Henn.



Screws (F/G) are to be used only when this module is mated to another Henn buildable module.

LISTA DE PEÇAS | LISTA DE PIEZAS | LIST OF PIECES

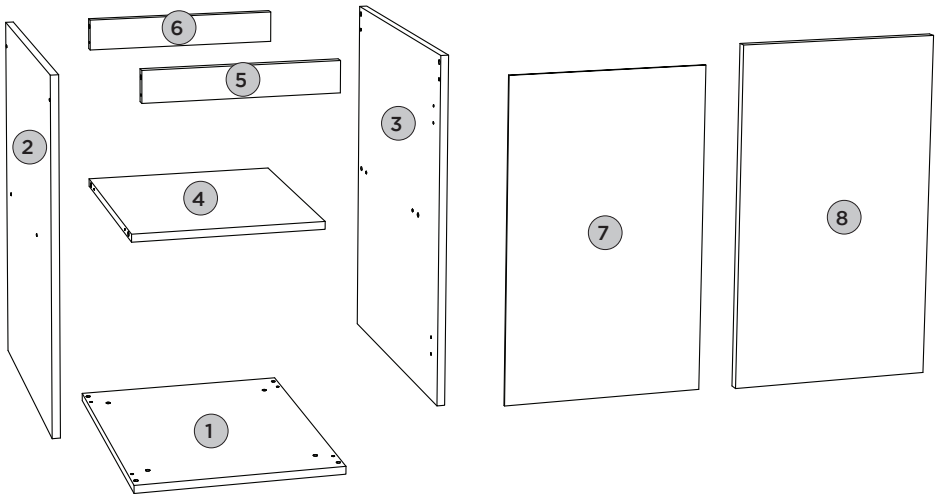

Item	Caixa Caja Box	Qty Ctd Qty	Descrição Descripción Description	Dimensões (mm) Dimensiones (mm) Dimensions (mm)		
				Comprimento Largo Length	Largura Ancho Width	Espessura Grosor Thickness
1	1/1	01	BASE BASE BASE	490	400	15
2	1/1	01	LATERAL ESQUERDA LATERAL IZQUIERDA LEFT SIDE	660	490	15
3	1/1	01	LATERAL DIREITA LATERAL DERECHA RIGHT SIDE	660	490	15
4	1/1	01	PRATELEIRA ESTANTE SHELF	400	368	15
5	1/1	01	TRAVESSA FRONTAL TRAVESAÑO FRONTAL FRONT CROSSBAR	368	60	15
6	1/1	01	TRAVESSA TRASEIRA TRAVESAÑO TRASERO REAR BUMPER	368	60	15
7	1/1	01	FUNDO FONDO BOTTOM	627	392	3
8	1/1	01	PORTA PUERTA DOOR	665	396	15





PASSO 1

ITM/C638-

PEÇAS REQUERIDAS

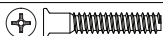
1	BASE	x1
2	LATERAL ESQUERDA	x1
3	LATERAL DIREITA	x1
4	PRATELEIRA	x1
5	TRAVESSA FRONTAL	x1
6	TRAVESSA TRASEIRA	x1

ACESSÓRIOS REQUERIDOS

C		04
I		12
N		04
T		

FERRAMENTAS NECESSÁRIAS

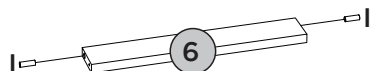
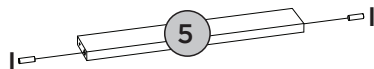
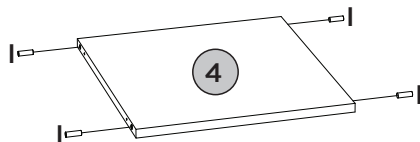
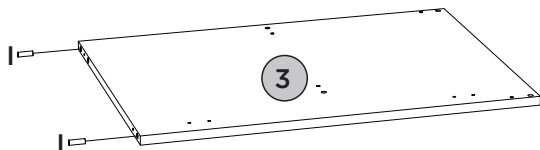
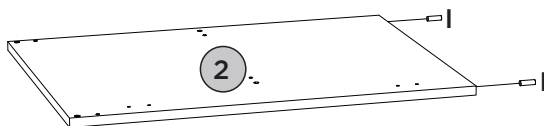
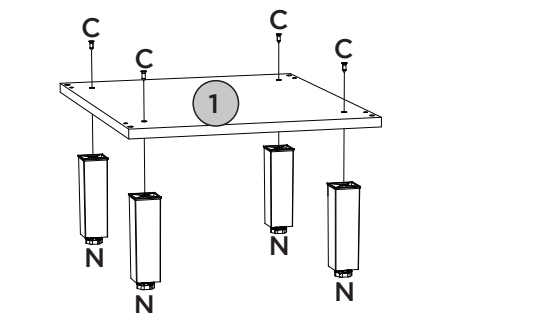
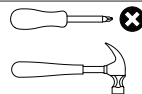

Utilizar o sachê de cola (T) em todas as cavilhas (I) do produto.

Con el pegamento sobre (T) en todos los pernos (I) producto.

Use the glue sachet (T) on all the pegs (I) of the product.



PASSO 2

ITM/C638-

PEÇAS REQUERIDAS

1	BASE	x1
2	LATERAL ESQUERDA	x1
3	LATERAL DIREITA	x1
4	PRATELEIRA	x1
5	TRAVESSA FRONTAL	x1
6	TRAVESSA TRASEIRA	x1





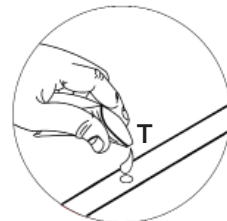
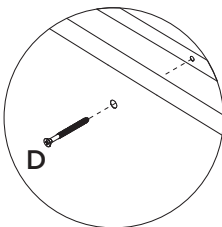
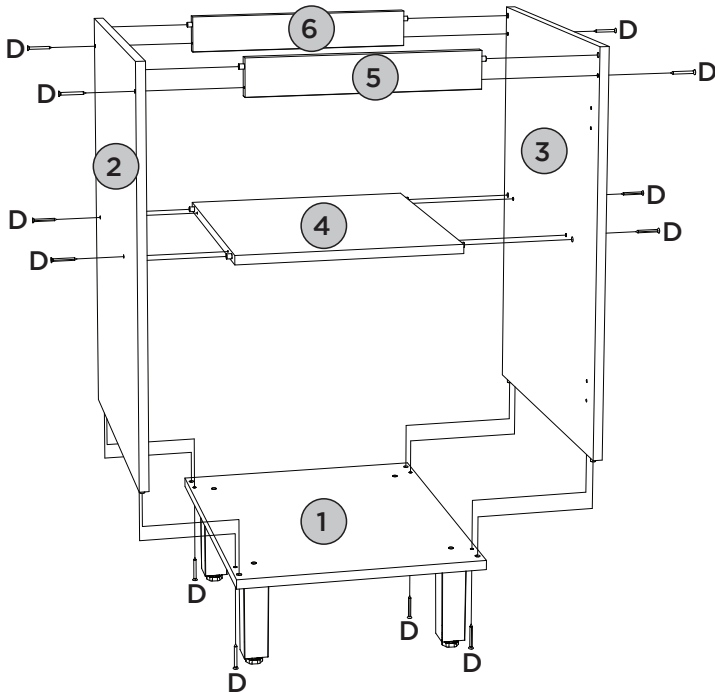
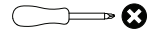

ACESSÓRIOS REQUERIDOS

D			12
T			

FERRAMENTAS NECESSÁRIAS



ACESSÓRIOS REQUERIDOS

B			02
H			08
K			04

FERRAMENTAS NECESSÁRIAS

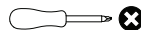

Esse tampo é opcional e é vendido separadamente (C902-128).

Esta vez es opcional y se vende por separado (C902-128).

This top is optional and is sold separately (C902-128).

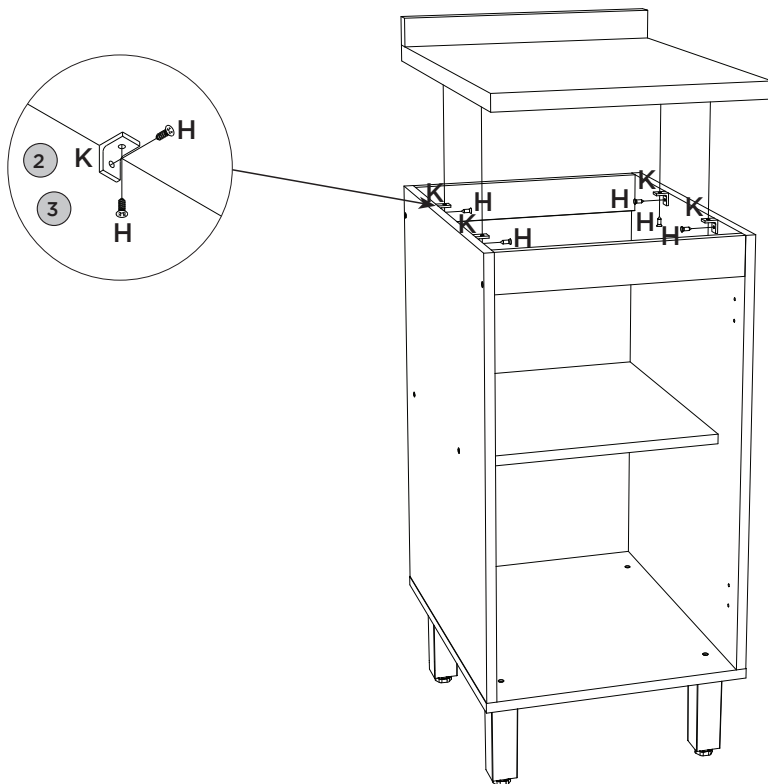
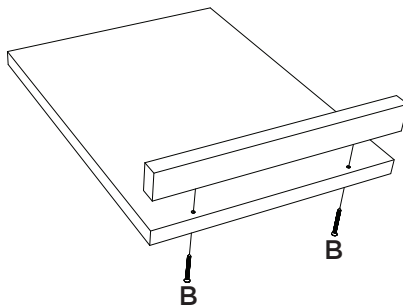

PASSO 4

ITM/C638-

PEÇAS REQUERIDAS

7	FUNDO	x1
---	-------	----

ACESSÓRIOS REQUERIDOS

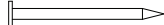
H		04
J		20

FERRAMENTAS NECESSÁRIAS

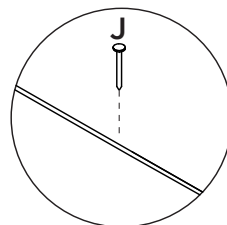
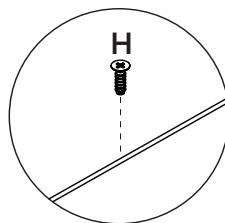
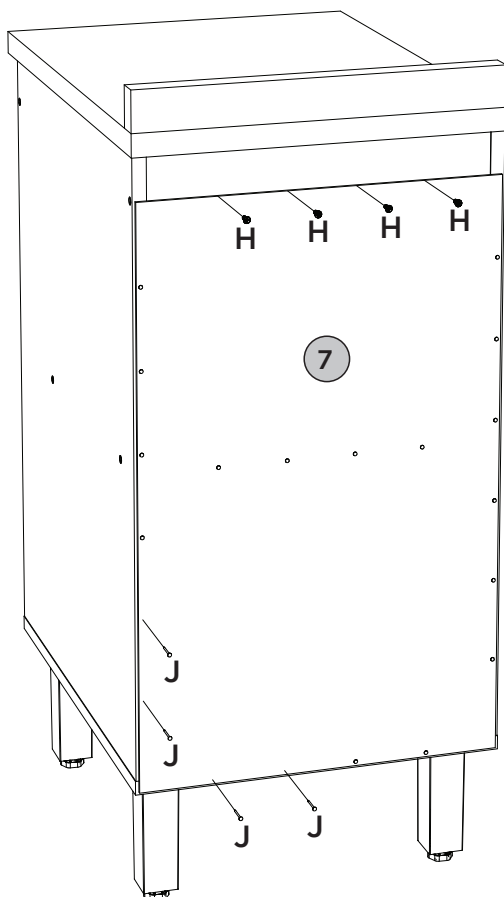
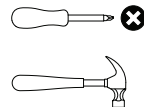

Fixar os pregos a uma distância de 100mm de um para outro.



Fijar las uñas a un distancia de 100mm uno a otro.

Fix the nails at a distance of 100mm from one to the other

PEÇAS REQUERIDAS

8	PORTA	x1
---	-------	----

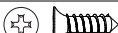
ACESSÓRIOS REQUERIDOS

H		04
M		02



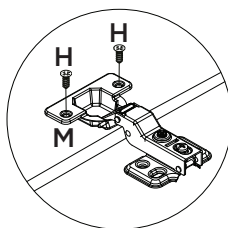
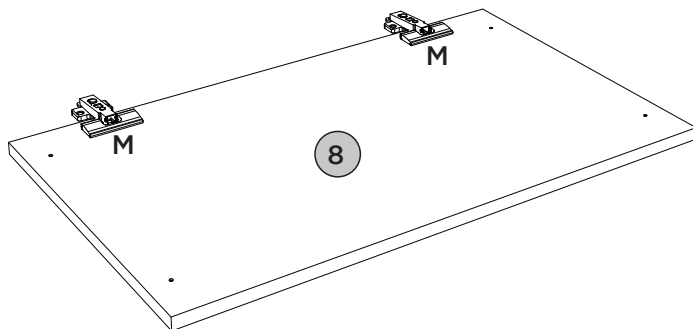
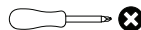

FERRAMENTAS NECESSÁRIAS



PEÇAS REQUERIDAS

8	PORTA	x1
---	-------	----

ACESSÓRIOS REQUERIDOS

E	 	02
H	 	08
L		01

FERRAMENTAS NECESSÁRIAS

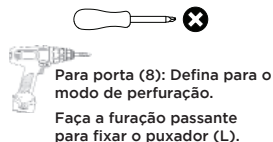



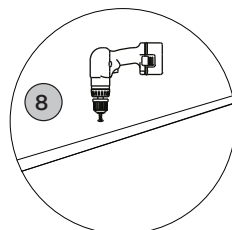
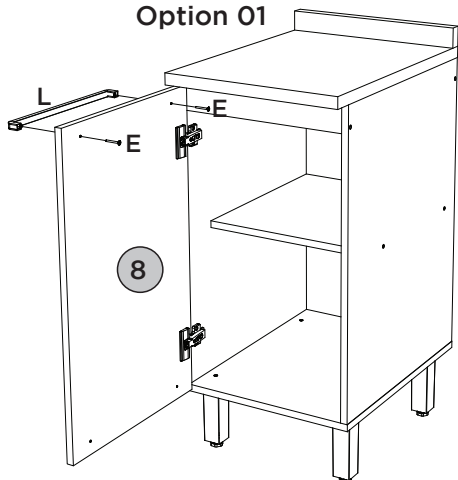

Opção 01
Opción 01
Option 01

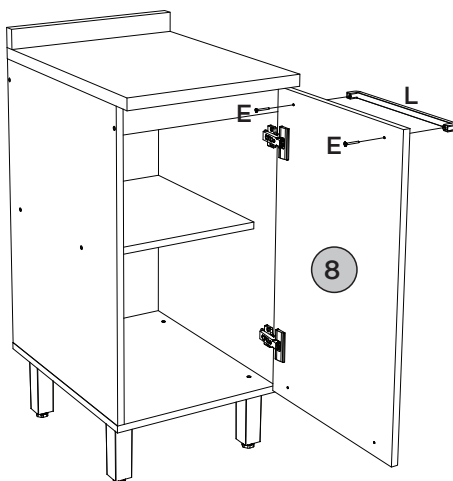
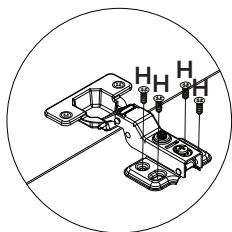



Opção 02
Opción 02
Option 02



ACESSÓRIOS REQUERIDOS

A		01
H		02
O		01
P		01

Q		01
R		14
S		04

FERRAMENTAS NECESSÁRIAS



OU

Para parede: Ajustar no modo perfuração

Pesos máximos recomendados com carga distribuída
Peso máximo recomendado con la carga distribuida
Recommended maximum weight with distributed load.

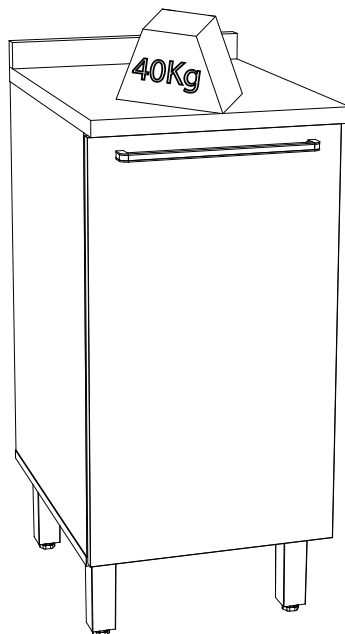
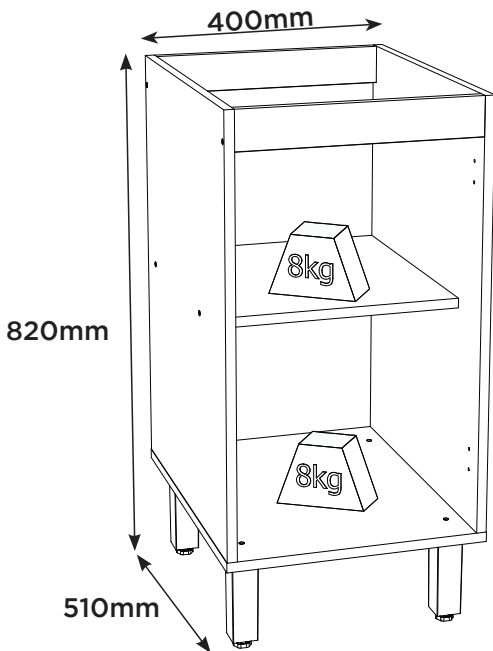

RECOMENDAÇÃO

Para fixar o móvel na parede usar o suporte de fixação (P), o parafuso 4,0x14mm CHT (H), a Bucha 8mm (O) e o parafuso 5,0x50mm FLA (A).

RECOMENDACIÓN

Para conectar el móvil a la pared con el soporte (P), tornillo 4,0x14mm CHT (H), el casquillo de 8 mm (O) y el 5,0 x50mm tornillo FLA (A).

RECOMMENDATION

To fix the furniture to the wall use the fixing bracket (P), the 4,0x14mm CHT (H) screw, the 8mm bushing (O) and the 5.0x50mm FLA screw (A).

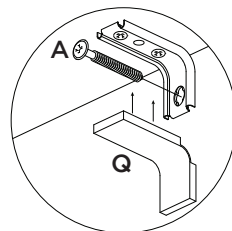
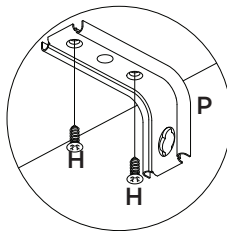
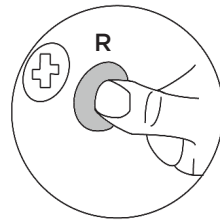
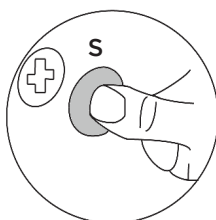

Producto Concluído
Producto terminado
Finished Product

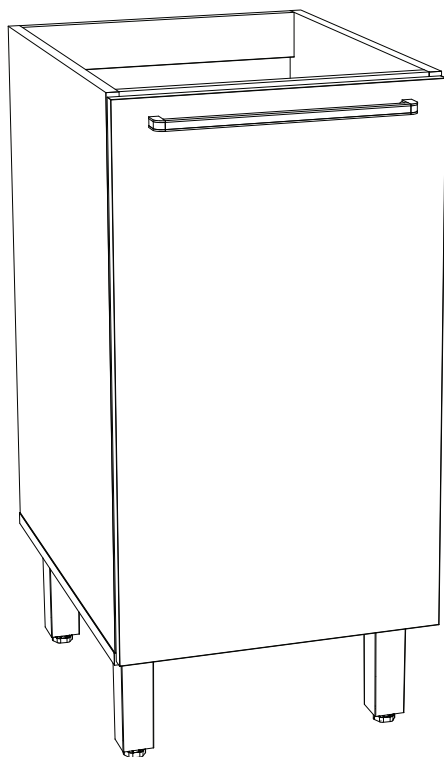

HENNInd. e Com. de Móveis Henn
Mondai - SC - Brasil

☎ +55 49 3674.3500

📱 @moveishenn
www.henn.com.br**INSTRUÇÕES DE
MONTAGEM**INSTRUCCIONES DE MONTAJE
ASSEMBLY INSTRUCTIONS**Balcão Porta Toalha Requite | Balcón Puerta Toalla
Requite | Towel Door Counter Requite**

C642-128 Nature

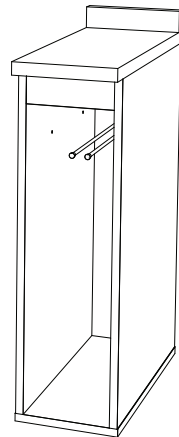
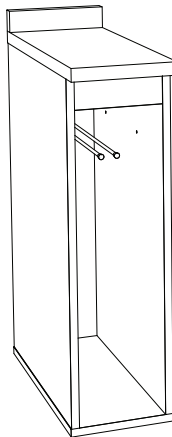
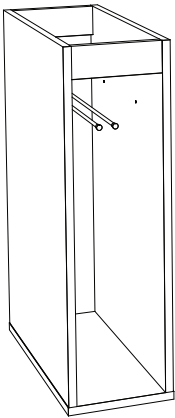
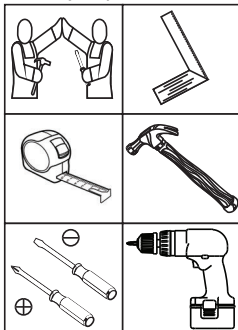
Opção 01
Opción 01
Option 01Opção 02
Opción 02
Option 02Requisitos para montagem
Requisitos para la montaje
Assembly RequirementsImagens meramente ilustrativas,
não acompanha o produto.
Imágenes ilustrativas, no incluidas
con el producto.
Illustrative images, not included
with the product.**AVISO**

Para limpeza de seu móvel, use uma flanela seca ou umedecida, e não utilize produtos químicos que possam danificar seu produto.

SISTEMA DE MONTAGEM

O sistema de montagem dos produtos, funciona de acordo com a ordem crescente dos números indicados no desenho. Ex: 01, 02, 03, 04... até a conclusão da montagem.

ASSISTÊNCIA TÉCNICA

Para solicitação de Assistência Técnica você consumidor deverá entrar em contato com o Lojista o qual você realizou a compra deste produto e solicitar a assistência técnica das peças avariadas. A garantia abrange todas as peças, partes e componentes que eventualmente venham apresentar defeito de fabricação no prazo de 03 (três) meses, contando a partir da entrega do produto ao consumidor, mediante nota fiscal de compra. Se houver qualquer alteração na estrutura do produto ou ocorrer defeito por negligência do montador/consumidor em relação a instrução de montagem e manuseio, não será fornecido assistência técnica gratuita.

ADVERTENCIA

Para limpieza de su móvil, use una flanela seca o húmeda, y no utilice productos químicos que puedan dañar su producto.

SISTEMA DE MONTAJE

El sistema de montaje de los productos funciona de acuerdo con el orden creciente de los números indicados en el dibujo. Ej.: 01, 02, 03, 04... hasta la conclusión del montaje.

ASISTENCIA TÉCNICA

Para solicitar Asistencia Técnica, el consumidor debe comunicarse con el Comercio que usted realizó la compra de este producto y solicita asistencia técnica para las partes dañadas. La garantía cubre todas las partes, piezas y componentes que eventualmente puedan presentar defecto de fabricación en el plazo de 03 (tres) meses, contados a partir de la entrega del producto al consumidor, mediante factura de compra. Si se produce algún cambio en la estructura del producto o se produce un defecto por negligencia del montador/consumidor en relación con las instrucciones de montaje y manipulación, no se prestará asistencia técnica gratuita.

NOTICE

To clean your furniture, use a dry or wet cloth, and do not use chemicals that may damage your product.

ASSEMBLY SYSTEM

The products' assembly system works according to the increasing order of the indicated numbers. For example: 01, 02, 03, 04 ... to the end of the assembly.

TECHNICAL ASSISTANCE

To request Technical Assistance, the consumer must contact the retailer from whom you purchased this product and request technical assistance for the damaged parts. The warranty covers all parts, parts and components that may eventually present a manufacturing defect within a period of 03 (three) months, counting from the delivery of the product to the consumer, by means of a purchase invoice. If there is any change in the structure of the product or defect occurs due to negligence of the assembler/consumer in relation to the assembly and handling instruction, free technical assistance will not be provided.

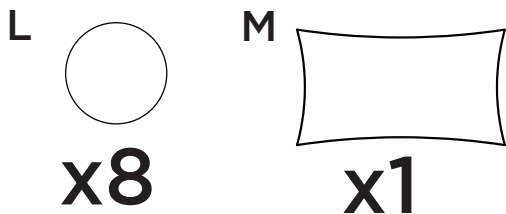
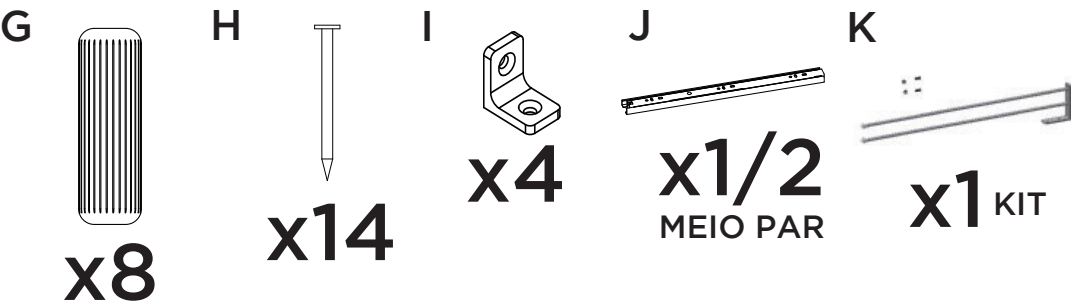
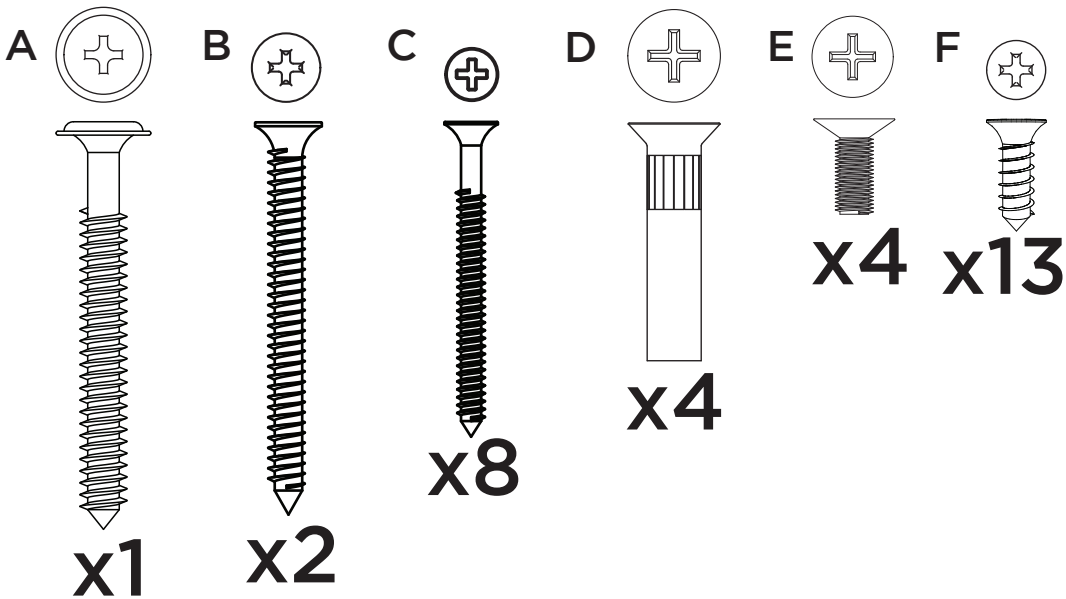



Parafusos em escala
Tornillos escalados
Scaled screws **1:1**

 Os parafusos (D/E) devem ser usados somente quando este módulo for acoplado a outro módulo componível Henn.

 Los tornillos (D/E) se debe utilizar sólo cuando el módulo está conectado a otro módulo componible Henn.

 Screws (D/E) are to be used only when this module is mated to another Henn buildable module.

 Caso houver a necessidade de editar o produto, a fita de borda deverá ser utilizada para acabamento.

 En caso de necesidad de editar el producto, la cinta de borde debe utilizarse para el acabado.

 If you need to edit the product, the edge tape should be used for finishing.

LISTA DE PEÇAS | LISTA DE PIEZAS | LIST OF PIECES

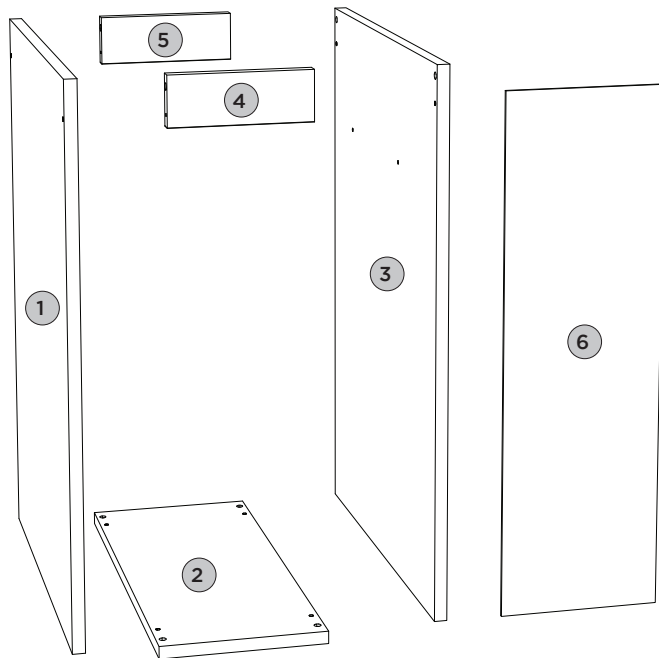

Item	Caixa Caja Box	Qty Ctd Qty	Descrição Descripción Description	Dimensões (mm) Dimensiones (mm)		
				Comprimento Largo Length	Largura Ancho Width	Espessura Grosor Thickness
1	1/1	1	LATERAL ESQUERDA LADO IZQUIERDE LEFT SIDE	660	490	15
2	1/1	1	BASE BASE BASE	490	200	15
3	1/1	1	LATERAL DIREITA LADO DERECHO RIGHT SIDE	660	490	15
4	1/1	1	TRAVESSA FRONTAL TRAVESSAÑO DELANTERO FRONT CROSS MEMEBER	168	60	15
5	1/1	1	TRAVESSA TRASEIRA TRAVESSAÑO TRASERO BACK CROSS MEMEBER	168	60	15
6	1/1	1	FUNDO FONDO BACKGROUND	627	192	3





PASSO 1

ITM/C642-

PEÇAS REQUERIDAS

1	LATERAL ESQUERDA	x1
3	LATERAL DIREITA	x1
4	TRAVESSA FRONTAL	x1
5	TRAVESSA TRASEIRA	x1

ACESSÓRIOS REQUERIDOS

F		07
G		08
I		04
J		1/2
M		

FERRAMENTAS NECESSÁRIAS

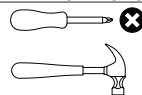

Opção 01
Opción 01
Option 01

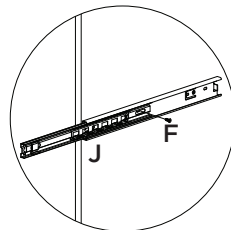
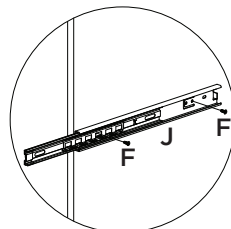
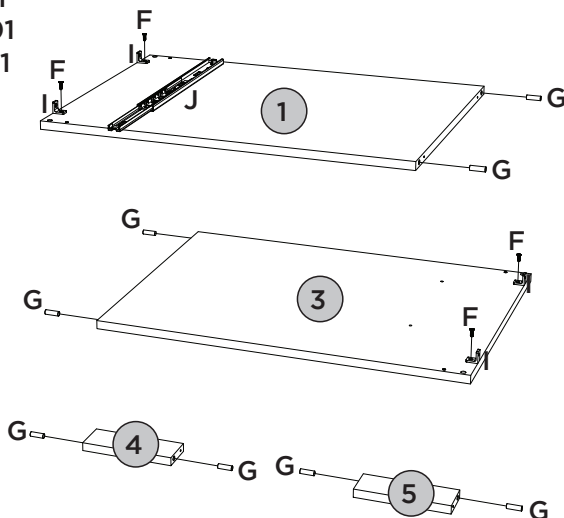

Opção 02
Opción 02
Option 02

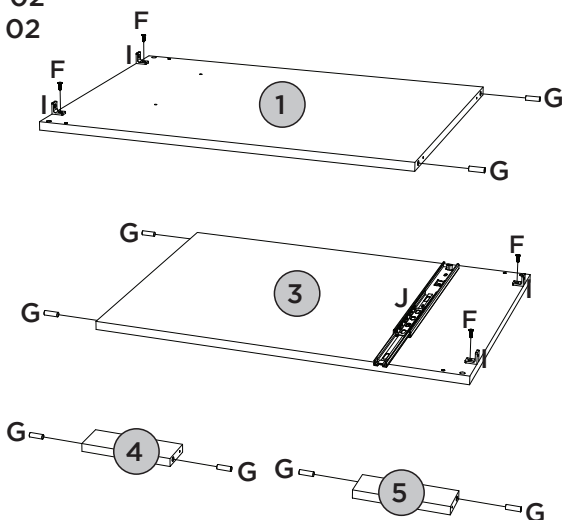

Utilizar o sachê de cola (M) em todas as cavilhas (G) do produto.

Con el pegamento sobre (M) en todos los pernos (G) producto.

Use the glue sachet (M) on all the pegs (G) of the product.



PASSO 2

ITM/C642-

PEÇAS REQUERIDAS

1	LATERAL ESQUERDA	x1
2	BASE	x1
3	LATERAL DIREITA	x1
4	TRAVESSA FRONTAL	x1
5	TRAVESSA TRASEIRA	x1

ACESSÓRIOS REQUERIDOS

C		08
M		

FERRAMENTAS NECESSÁRIAS

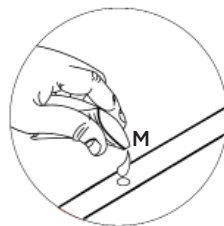
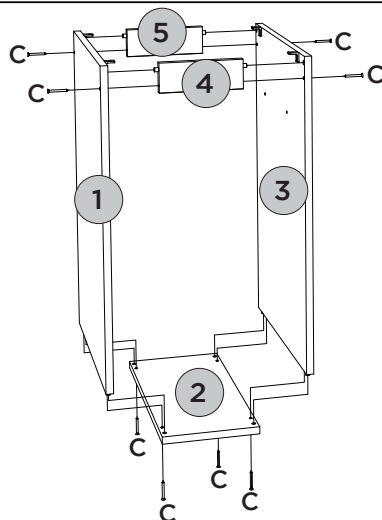
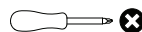



PASSO 3

PEÇAS REQUERIDAS

6	FUNDO	x1
---	-------	----

ACESSÓRIOS REQUERIDOS

F		02
H		14

FERRAMENTAS NECESSÁRIAS

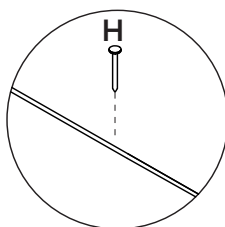
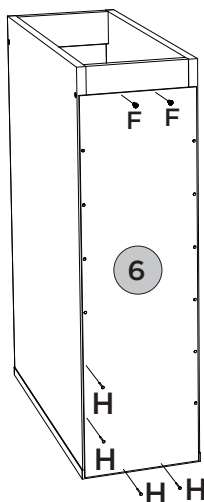
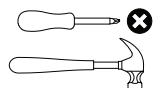





Fixar os pregos a uma distância de 100mm de um para outro.

Fijar las uñas a un distancia de 100 mm uno a otro.

Fix the nails at a distance of 100mm from one to the other

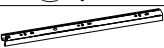
ACESSÓRIOS REQUERIDOS

B		02
F		04
J		1/2
K		01

FERRAMENTAS NECESSÁRIAS

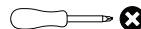

Esse topo é opcional e é vendido separadamente (C900-128).

Esta vez es opcional y se vende por separado (C900-128).

This top is optional and is sold separately (C900-128).

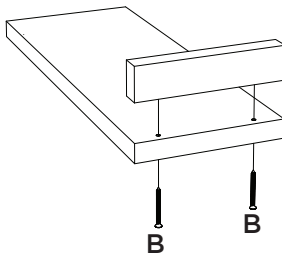

Opção 01
Opción 01
Option 01

Opção 02
Opción 02
Option 02

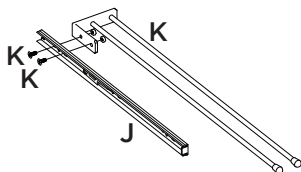
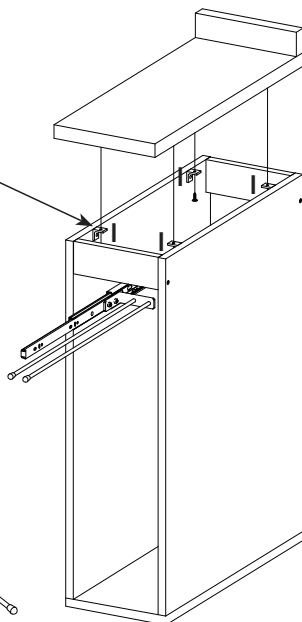
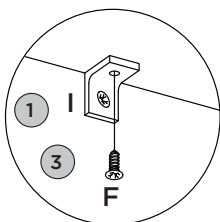



Fixação do toalheiro (K)
na corredeira (J).

La fijación de latoalla
(K) el control deslizante
(J).

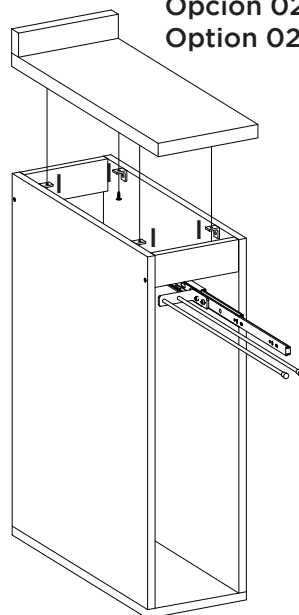
fixing the towel rail (K)
on the slide (J).



ACESSÓRIOS REQUERIDOS

A		01
L		08

FERRAMENTAS NECESSÁRIAS



OU



Para parede: Ajustar no modo perfuração

Pesos máximos recomendados com carga distribuída
 Peso máximo recomendado con la carga distribuida
 Recommended maximum weight with distributed load.

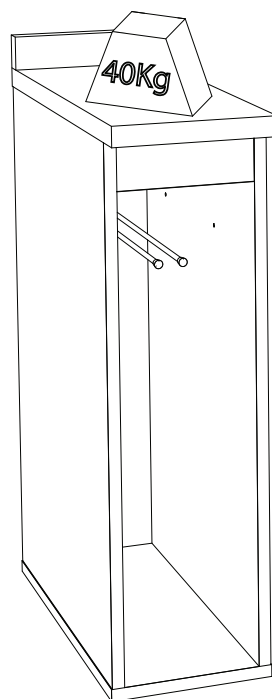
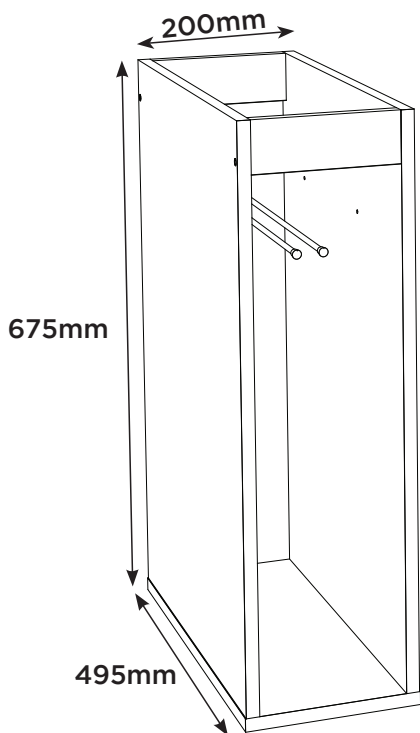

RECOMENDAÇÃO

Para fixar o móvel na parede usar o parafuso 5,0x50mm FLA (A).

RECOMENDACIÓN

Para conectar el móvil a la pared con el 5,0 x50mm tornillo FLA (A).

RECOMMENDATION

To fix the furniture to the wall use the 5.0x50mm FLA screw (A).

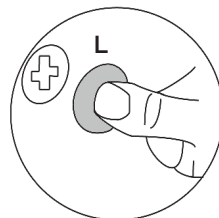

Producto Concluído
Producto terminado
Finished Product

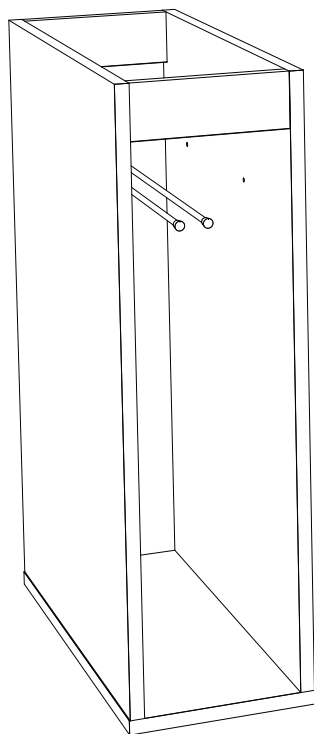

HENNInd. e Com. de Móveis Henn
Mondai - SC - Brasil

☎ +55 49 3674.3500

📧 @moveishenn
www.henn.com.br**INSTRUÇÕES DE MONTAGEM**INSTRUCCIONES DE MONTAJE
ASSEMBLY INSTRUCTIONS**Tampo para Balcão 200mm** | Tablero para Balcón 200mm | Counter Top 200mm

- C900-23 - Duna
- C900-33 - Nero
- C900-114 - Calcare

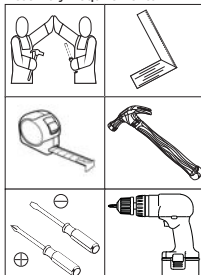
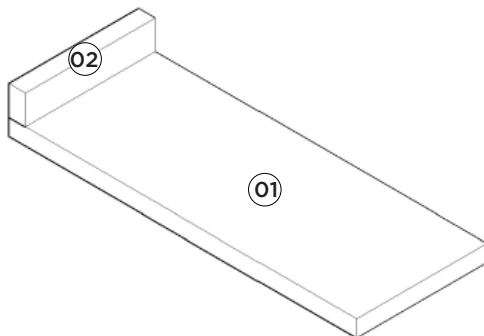
Requisitos para montagem
Requisitor para la montaje
Assembly RequirementsImagens meramente ilustrativas
Imágenes meramente ilustrativas
Images for illustration only**AVISO**

Para limpeza de seu móvel, use uma flanela seca ou umedecida, e não utilize produtos químicos que possam danificar seu produto.

SISTEMA DE MONTAGEM

O sistema de montagem dos produtos, funciona de acordo com a ordem crescente dos números indicados no desenho. Ex: 01, 02, 03, 04... até a conclusão da montagem.

ADVERTENCIA

Para limpieza de su móvil, use una franela seca o húmeda, y no utilice productos químicos que puedan dañar su producto.

SISTEMA DE MONTAJE

El sistema de montaje de los productos funciona de acuerdo con el orden creciente de los números indicados en el dibujo. Ej.: 01, 02, 03, 04... hasta la conclusión del montaje.

NOTICE

To clean your furniture, use a dry or wet cloth, and do not use chemicals that may damage your product.

ASSEMBLY SYSTEM

The products' assembly system works according to the increasing order of the indicated numbers. For example: 01, 02, 03, 04 ... to the end of the assembly.

Lista de Peças | Lista de piezas | List of parts

Item	Caixa Caja Box	Qty Ctd Qty	Descrição Descripción Description	Medidas (mm) Dimensions (mm) Size (measure- ments) (mm)
01	1/1	01	Tampo Tapa Top	533x200x25
02	1/1	01	Rodatampo Rodatampo Rodatampo	200x45x25

Ferragens | Herrajes | Hardware

A	02x	B	08x	C	04x
Parafuso 4,5x50mm CHT. Tornillo 4,5x50mm CHT. Screw 4,5x50mm CHT.		Parafuso 3,5x14mm FLA. Tornillo 3,5x14mm FLA. Screw 3,5x14mm FLA.		Cantoneira plástica Cantонера plástica Plastic angle brackets	

Estas ferragens constam no Pacote do respectivo Balcão.
Estos herrajes constan en el Paquete del respectivo Balcón.
These hardware are included in the Package of the respective Counter.

Esse tampo é opcional e é vendido separadamente

Esta vez es opcional y se vende por separado

This top is optional and is sold separately

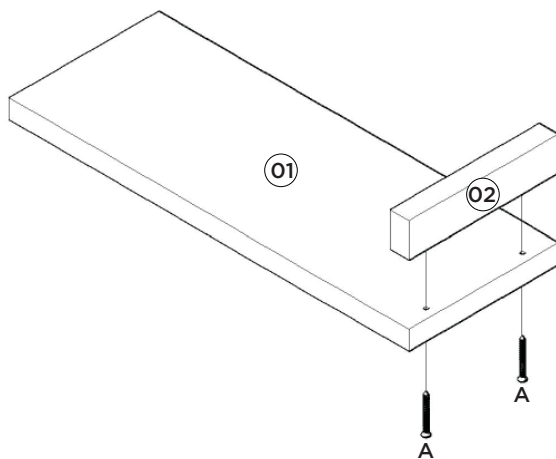

Exemplo de como fixar o Tampo no produto.

Ejemplo de la fijación de la tapa sobre el producto.

Example of fixing the lid on the product.

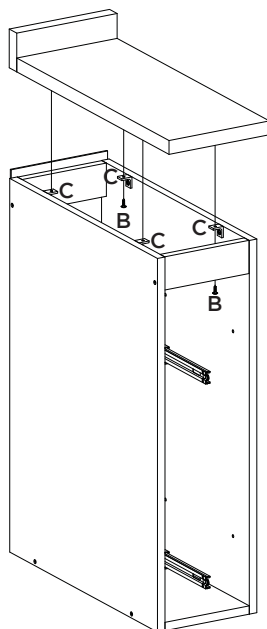

HENNInd. e Com. de Móveis Henn
Mondai - SC - Brasil

☎ +55 49 3674.3500

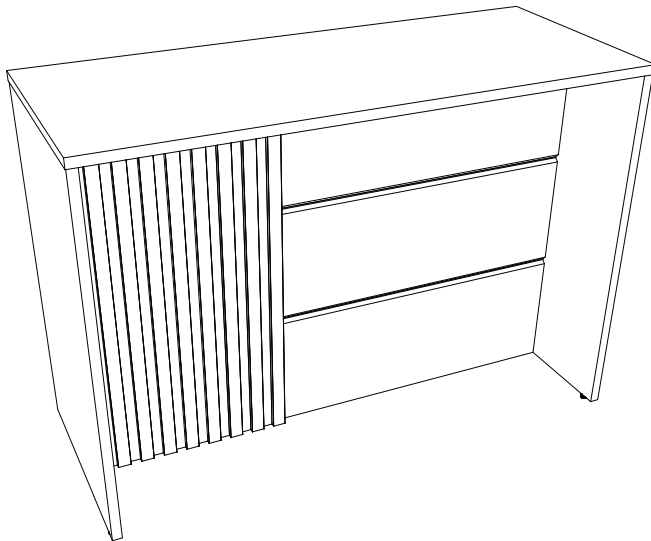
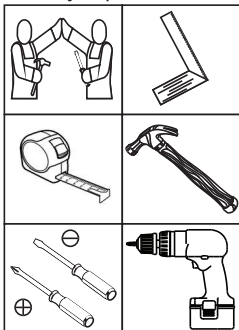
📧 @moveishenn
www.henn.com.br**INSTRUÇÕES DE
MONTAGEM**INSTRUCCIONES DE MONTAJE
ASSEMBLY INSTRUCTIONS**Bancada Gourmet Requite |
Mostrador Gourmet Requite |
Requite Gourmet Counter**C630-05 Branco HP
C630-35 Duna/Cristal
C630-131 Cinza HP
C630-139 Off White
C630-217 Nature/Areia**Requisitos para montagem
Requisitos para la montaje
Assembly Requirements**Imagens meramente ilustrativas,
não acompanha o produto.
Imágenes ilustrativas, no incluidas
con el producto.
Illustrative images, not included
with the product.**AVISO**

Para limpeza de seu móvel, use uma flanela seca ou umedecida, e não utilize produtos químicos que possam danificar seu produto.

SISTEMA DE MONTAGEM

O sistema de montagem dos produtos, funciona de acordo com a ordem crescente dos números indicados no desenho. Ex: 01, 02, 03, 04... até a conclusão da montagem.

ASSISTÊNCIA TÉCNICA

Para solicitação de Assistência Técnica você consumidor deverá entrar em contato com o Lojista o qual você realizou a compra deste produto e solicitar a assistência técnica das peças avariadas. A garantia abrange todas as peças, partes e componentes que eventualmente venham apresentar defeito de fabricação no prazo de 03 (três) meses, contando a partir da entrega do produto ao consumidor, mediante nota fiscal de compra. Se houver qualquer alteração na estrutura do produto ou ocorrer defeito por negligência do montador/consumidor em relação a instrução de montagem e manuseio, não será fornecido assistência técnica gratuita.

ADVERTENCIA

Para limpieza de su móvil, use una flanela seca o húmeda, y no utilice productos químicos que puedan dañar su producto.

SISTEMA DE MONTAJE

El sistema de montaje de los productos funciona de acuerdo con el orden creciente de los números indicados en el dibujo. Ej.: 01, 02, 03, 04... hasta la conclusión del montaje.

ASISTENCIA TÉCNICA

Para solicitar Asistencia Técnica, el consumidor debe comunicarse con el Comercio que usted realizó la compra de este producto y solicita asistencia técnica para las partes dañadas. La garantía cubre todas las partes, piezas y componentes que eventualmente puedan presentar defecto de fabricación en el plazo de 03 (tres) meses, contados a partir de la entrega del producto al consumidor, mediante factura de compra. Si se produce algún cambio en la estructura del producto o se produce un defecto por negligencia del montador/consumidor en relación con las instrucciones de montaje y manipulación, no se prestará asistencia técnica gratuita.

NOTICE

To clean your furniture, use a dry or wet cloth, and do not use chemicals that may damage your product.

ASSEMBLY SYSTEM

The products' assembly system works according to the increasing order of the indicated numbers. For example: 01, 02, 03, 04 ... to the end of the assembly.

TECHNICAL ASSISTANCE

To request Technical Assistance, the consumer must contact the retailer from whom you purchased this product and request technical assistance for the damaged parts. The warranty covers all parts, parts and components that may eventually present a manufacturing defect within a period of 03 (three) months, counting from the delivery of the product to the consumer, by means of a purchase invoice. If there is any change in the structure of the product or defect occurs due to negligence of the assembler/consumer in relation to the assembly and handling instruction, free technical assistance will not be provided.

ACESSÓRIOS | ACCESORIOS | ACCESSORIES

A **x42**

B

**x24**C **x19**

D

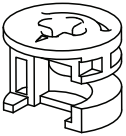
**x19**

E

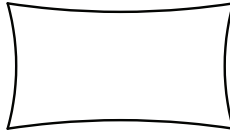
**x1**

F

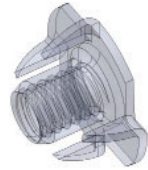
**x4**

G

**x4**

H

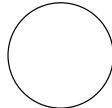
**x6**

I

**x1**

J

HENN**x1**

LISTA DE PEÇAS | LISTA DE PIEZAS | LIST OF PIECES

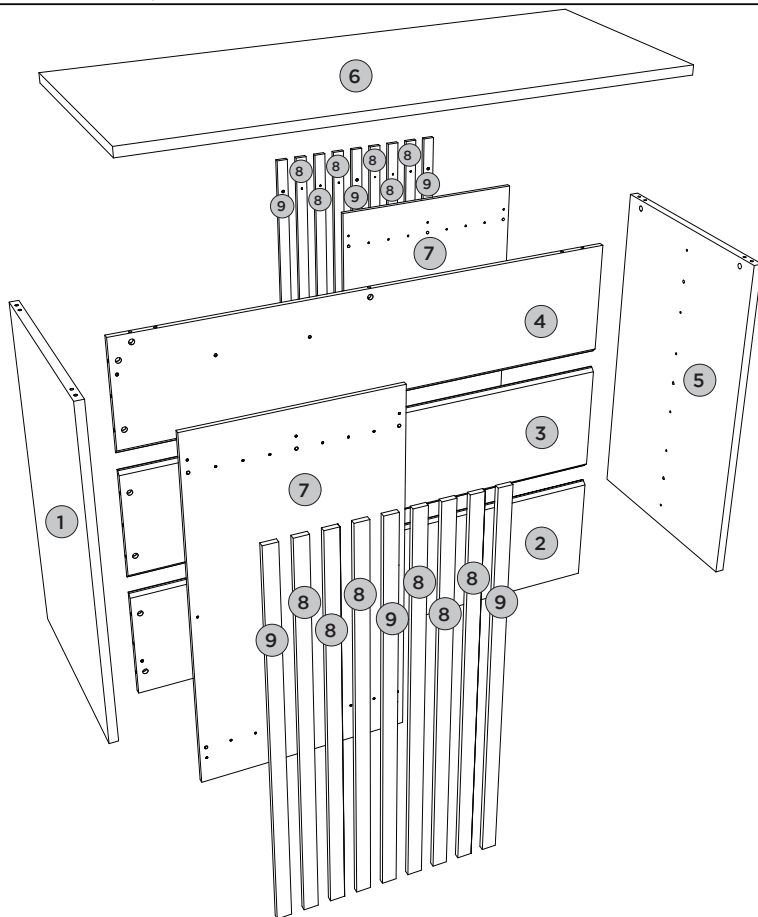





Item	Caixa Caja Box	Qtd Ctd Qty	Descrição Descripción Description	Dimensões (mm) Dimensiones (mm) Dimensions (mm)		
				Comprimento Largo Length	Largura Ancho Width	Espessura Grosor Thickness
1=5	1/1	01	LATERAL DIREITA ESQUERDA LADO IZQUIERDO DERECHO LEFT RIGHT SIDE	975	600	25
2	1/1	01	PAINEL INFERIOR PANEL INFERIOR BOTTOM PANEL	1402	325	15
3	1/1	01	PAINEL CENTRAL PANEL CENTRAL CENTER PANEL	1402	325	15
4	1/1	01	PAINEL SUPERIOR PANEL SUPERIOR TOP PANEL	1402	325	15
5=1	1/1	01	LATERAL DIREITA ESQUERDA LADO IZQUIERDO DERECHO LEFT RIGHT SIDE	975	600	25
6	1/1	01	TAMPO TAPA TOP	1456	603	25
7	1/1	02	PAINEL COM APLIQUE PANEL CON APLICACIÓN PANEL WITH APPLICATION	975	547	12
8	1/1	12	APLIQUE APLICAR APPLY	974	35	12
9	1/1	06	APLIQUE FURO MAIOR APLICAR AGUJERO MÁS GRANDE APPLY BIGGER HOLE	974	35	12

PASSO 1

PEÇAS REQUERIDAS

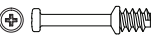
1=5	LATERAL DIREITA ESQUERDA	x2
6	TAMPO	x1

ACESSÓRIOS REQUERIDOS

B		04
C		19
E		
F		04
G		04

FERRAMENTAS NECESSÁRIAS

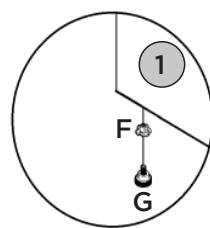
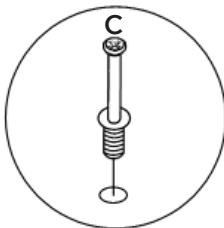
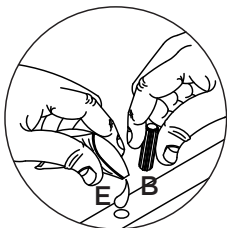
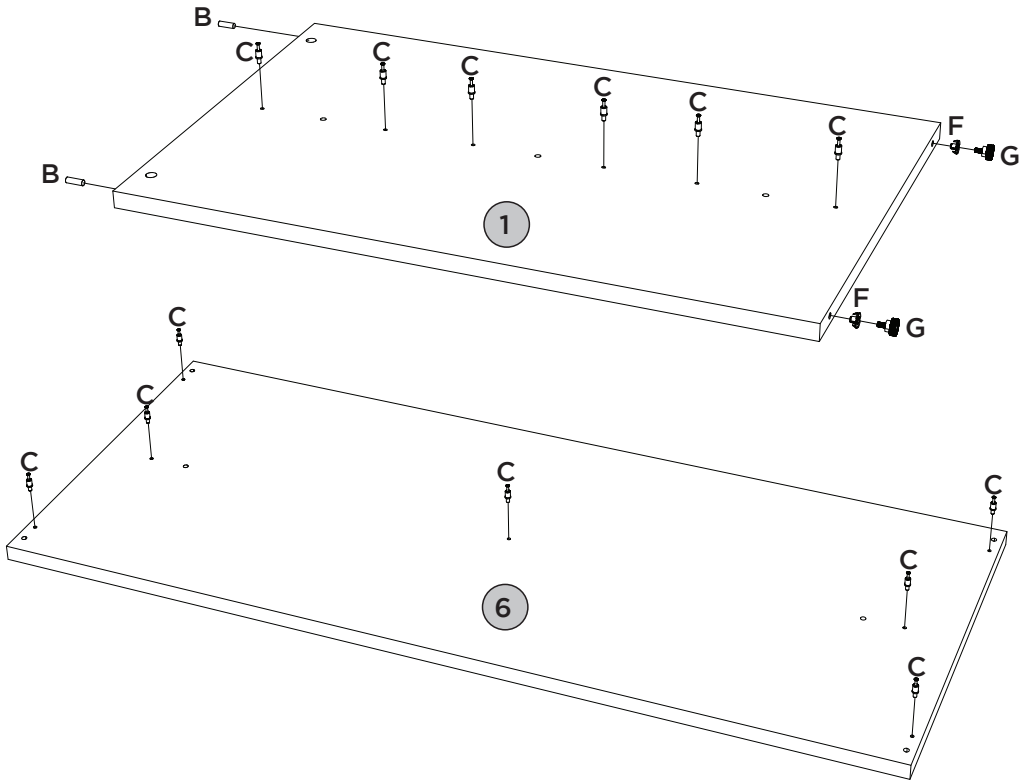
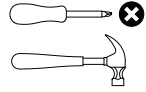



PASSO 2

ITM/C630-

PEÇAS REQUERIDAS

2	PAINEL INFERIOR	x1
3	PAINEL CENTRAL	x1
4	PAINEL SUPERIOR	x1
9	APLIQUE FURO MAIOR	x6

ACESSÓRIOS REQUERIDOS

B		20
E		

FERRAMENTAS NECESSÁRIAS

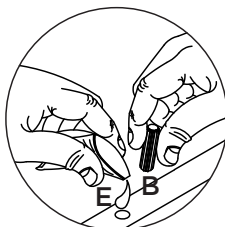
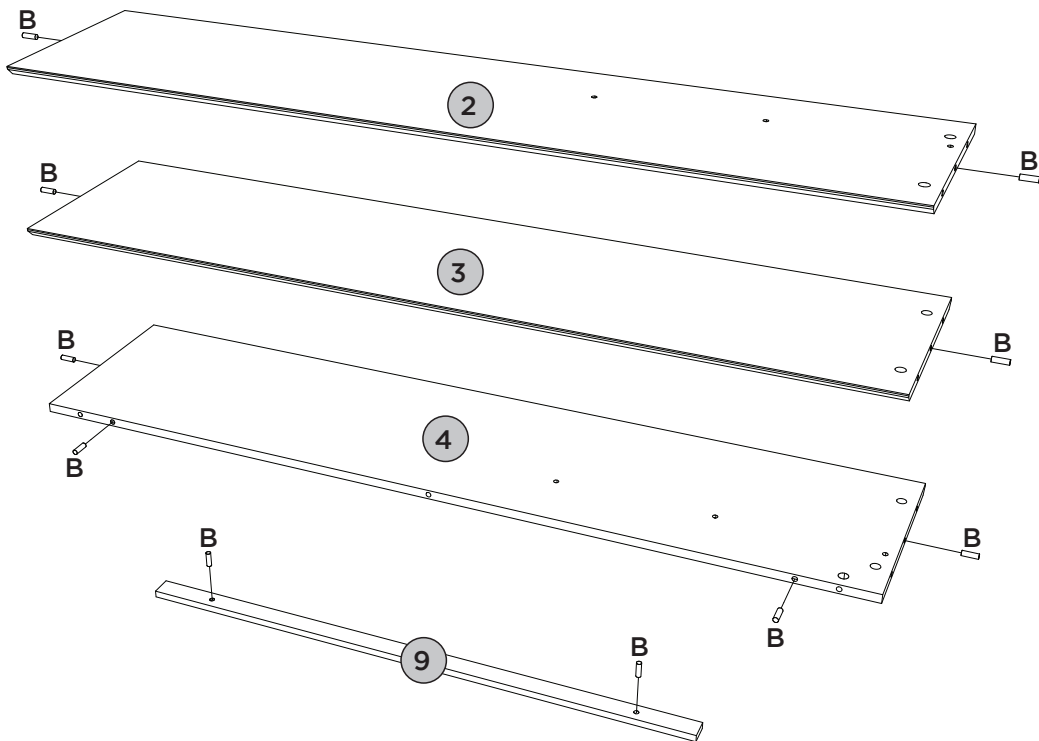
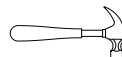

PASSO 3**PEÇAS REQUERIDAS**

1=5	LATERAL DIREITA ESQUERDA	x1
2	PAINEL INFERIOR	x1
3	PAINEL CENTRAL	x1
4	PAINEL SUPERIOR	x1
5=1	LATERAL DIREITA ESQUERDA	x1

ACESSÓRIOS REQUERIDOS

D		12
---	--	----

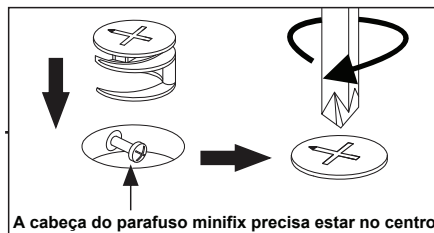
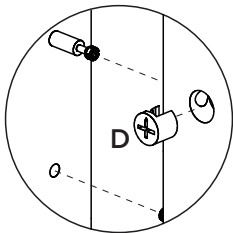
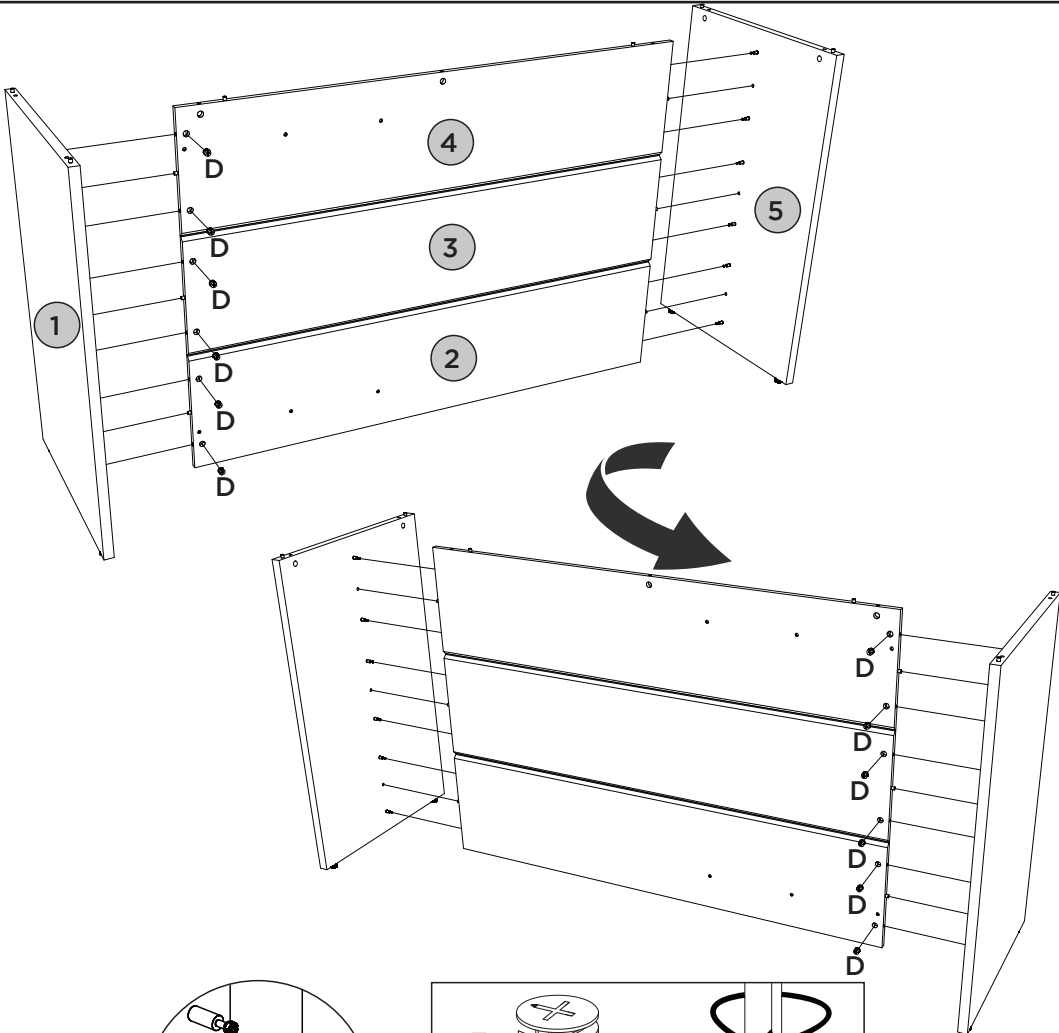
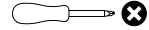
FERRAMENTAS NECESSÁRIAS

PEÇAS REQUERIDAS

ACESSÓRIOS REQUERIDOS

FERRAMENTAS NECESSÁRIAS

6	TAMPO	x1
---	-------	----

D		07
---	--	----

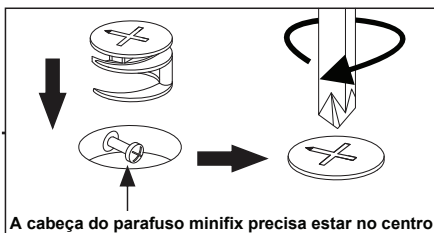
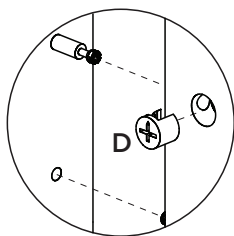
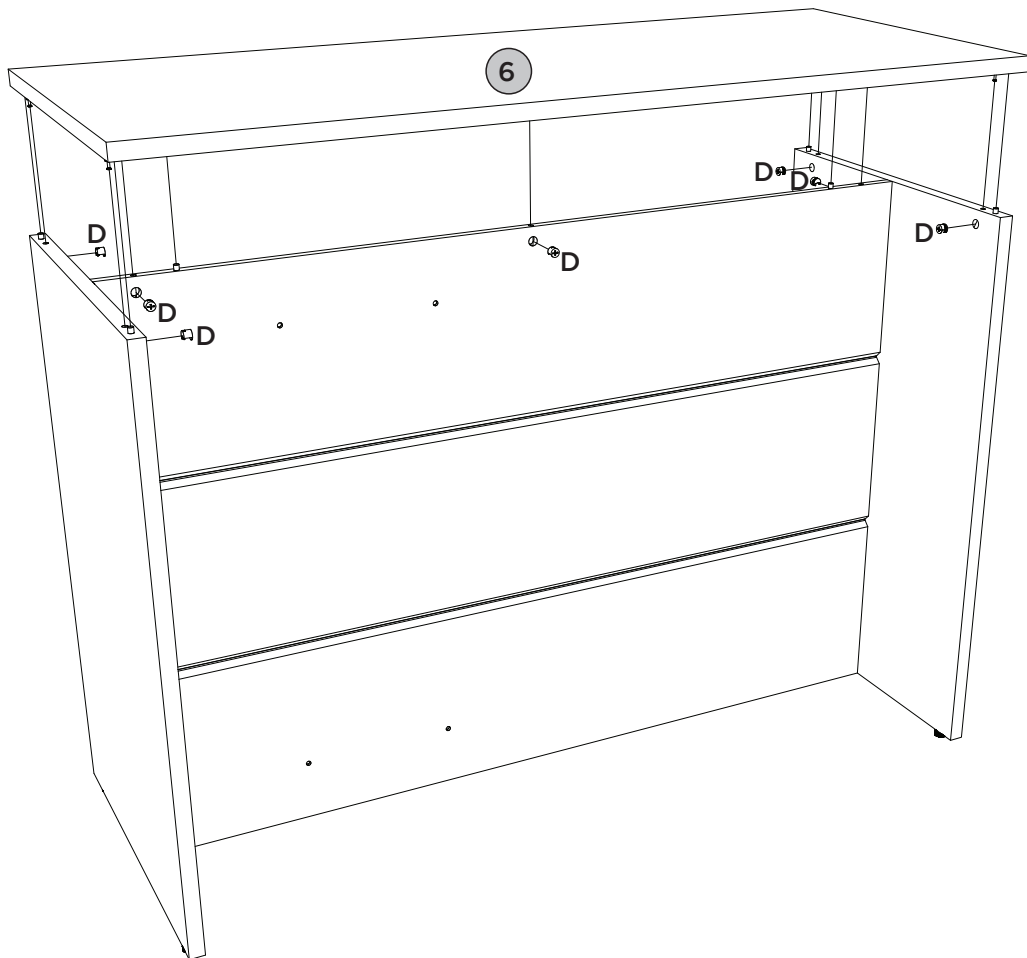
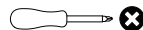

PEÇAS REQUERIDAS

7	PAINEL COM APLIQUE	x2
8	APLIQUE	x12

ACESSÓRIOS REQUERIDOS

A		24
---	--	----

FERRAMENTAS NECESSÁRIAS



2X

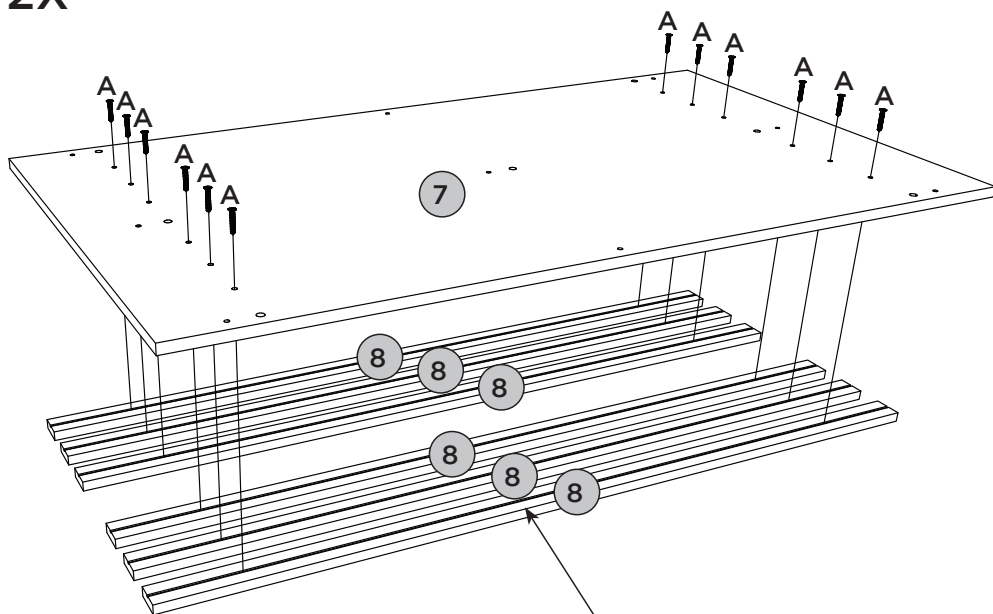

Apliques (8) devem estar alinhados com Painel com Aplique (7).
Utilizar o Friso para fixação dos parafusos (A).

PEÇAS REQUERIDAS

7	PAINEL COM APLIQUE	x2
---	--------------------	----

ACESSÓRIOS REQUERIDOS

A			18
---	---	---	----

FERRAMENTAS NECESSÁRIAS

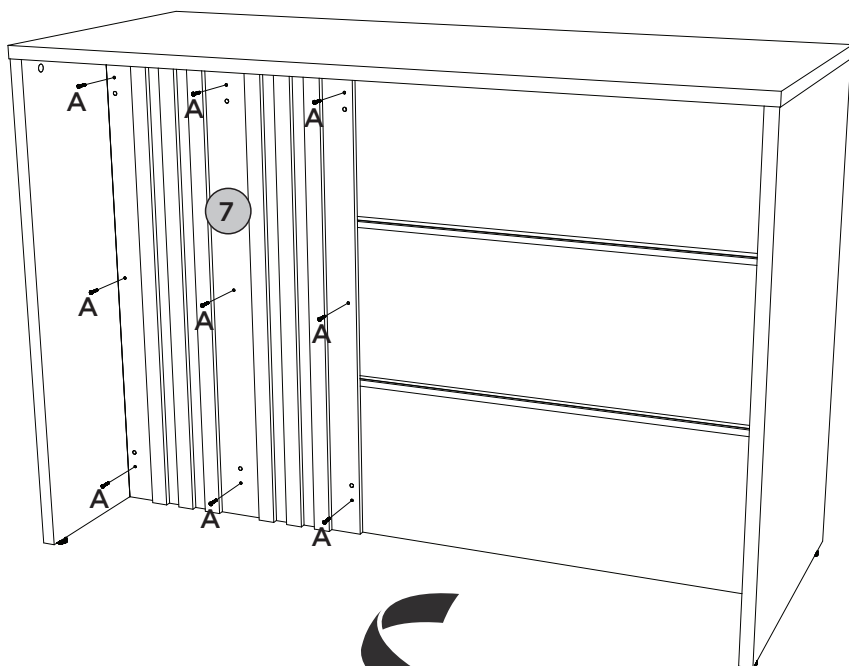
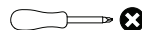

PEÇAS REQUERIDAS



9	APLIQUE FURO MAIOR	x6
---	--------------------	----

ACESSÓRIOS REQUERIDOS

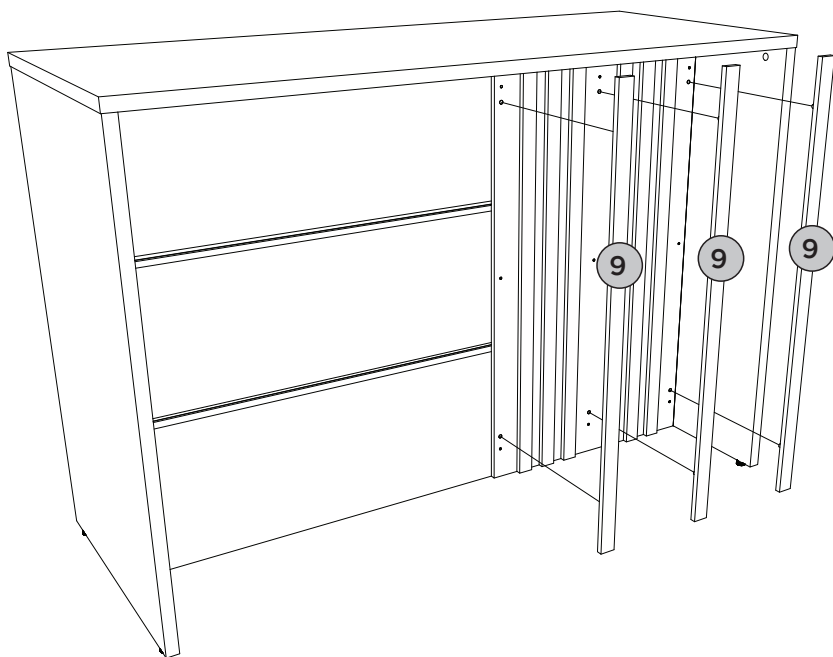
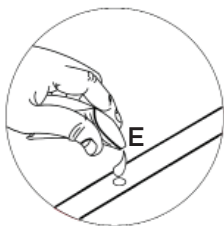
E		
---	--	--



ACESSÓRIOS REQUERIDOS

H		06
I		01
J		01

Pesos máximos recomendados com carga distribuída
 Peso máximo recomendado con la carga distribuida
 Recommended maximum weight with distributed load.

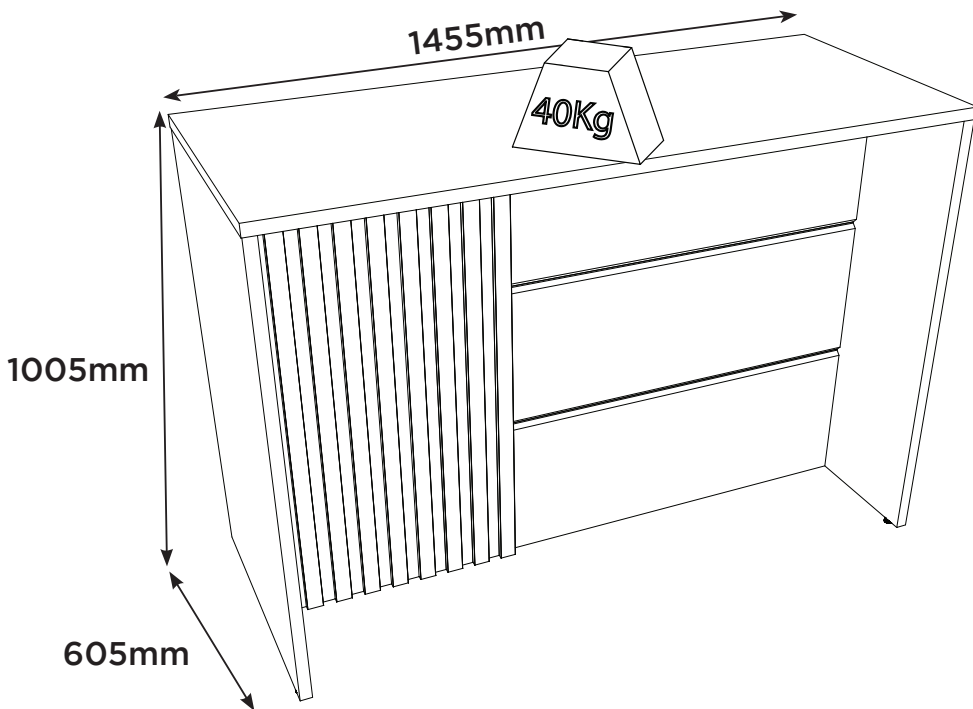

PERFECT CORRECTION
 CORRECCIÓN PERFECTA

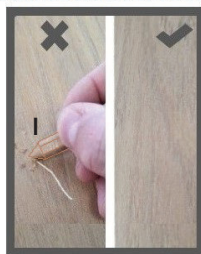
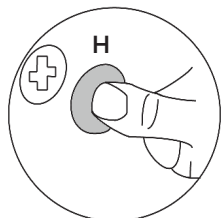

Produto Concluído
Producto terminado
Finished Product

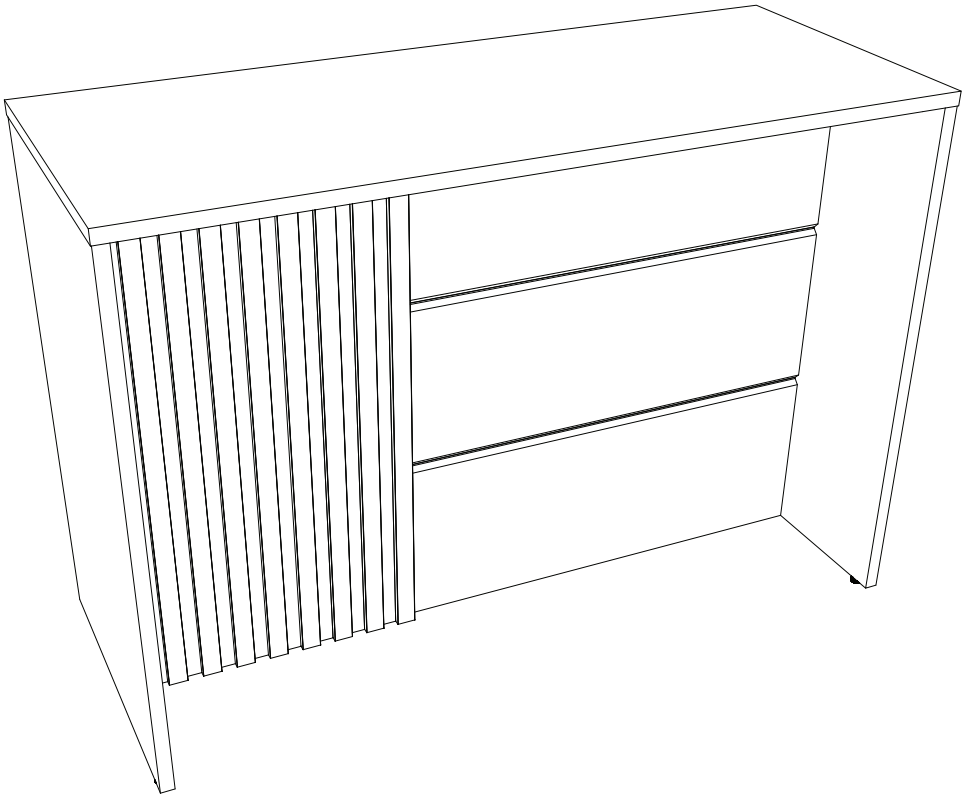

HENNInd. e Com. de Móveis Henn
Mondai - SC - Brasil

☎+55 49 3674.3500

📧@moveishenn
www.henn.com.br**INSTRUÇÕES DE MONTAGEM**INSTRUCCIONES DE MONTAJE
ASSEMBLY INSTRUCTIONS**Tampo para Balcão 1200mm | Tablero para Balcón 1200mm | Counter Top 1200mm**

- C905-23 Duna
- C905-33 Nero
- C905-90 Grafite HP
- C905-94 Rústico
- C905-114 Calcare

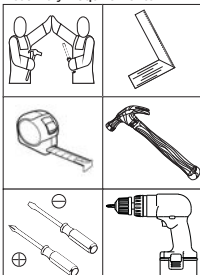
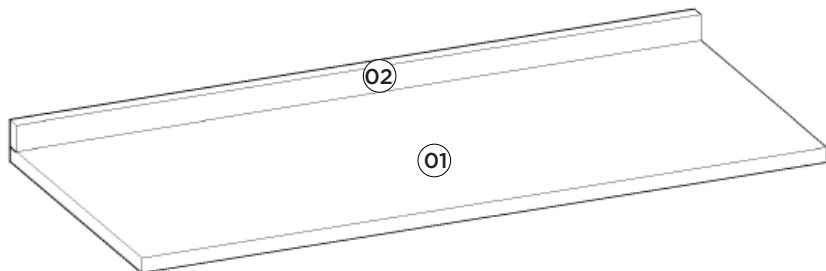
Requisitos para montagem
Requisitor para la montaje
Assembly RequirementsImagens meramente ilustrativas
Imágenes meramente ilustrativas
Images for illustration only**AVISO**

Para limpeza de seu móvel, use uma flanela seca ou umedecida, e não utilize produtos químicos que possam danificar seu produto.

SISTEMA DE MONTAGEM

O sistema de montagem dos produtos, funciona de acordo com a ordem crescente dos números indicados no desenho. Ex: 01, 02, 03, 04... até a conclusão da montagem.

ADVERTENCIA

Para limpieza de su móvil, use una franela seca o húmeda, y no utilice productos químicos que puedan dañar su producto.

Lista de Peças | Lista de piezas | List of parts

Item	Caixa Caja Box	Qtd Ctd Qty	Descrição Descripción Description	Medidas (mm) Dimensions (mm) Size (measure- ments) (mm)
01	1/1	01	Tampo Tapa Top	1200x533x25
02	1/1	01	Rodatampo Rodatampo Rodatampo	1200x45x25

SISTEMA DE MONTAJE

El sistema de montaje de los productos funciona de acuerdo con el orden creciente de los números indicados en el dibujo. Ej.: 01, 02, 03, 04... hasta la conclusión del montaje.

NOTICE

To clean your furniture, use a dry or wet cloth, and do not use chemicals that may damage your product.

Ferragens | Herrajes | Hardware

A	04x	B	12x	C	06x
Parafuso 4,5x50mm CHT. Tornillo 4,5x50mm CHT. Screw 4,5x50mm CHT.		Parafuso 3,5x14mm FLA. Tornillo 3,5x14mm FLA. Screw 3,5x14mm FLA.		Cantoneira plástica Cantонера plástica Plastic angle brackets	



Estas ferragens constam no Pacote do respectivo Balcão.
Estos herrajes constan en el Paquete del respectivo Balcón.
These hardware are included in the Package of the respective Counter.

ASSEMBLY SYSTEM

The products' assembly system works according to the increasing order of the indicated numbers. For example: 01, 02, 03, 04 ... to the end of the assembly.

Esse tampo é opcional e é vendido separadamente

Esta vez es opcional y se vende por separado

This top is optional and is sold separately

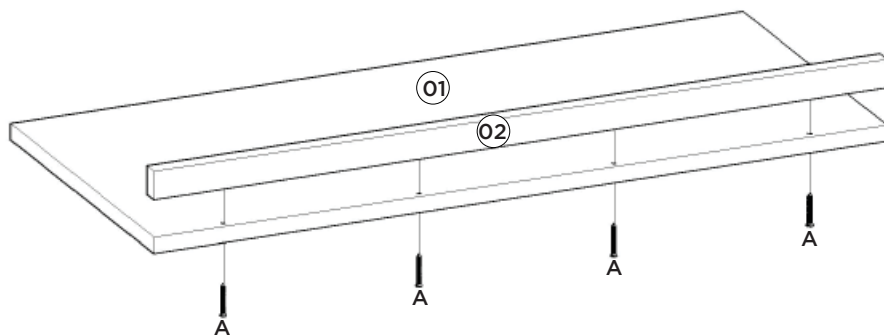

Exemplo de como fixar o Tampo no produto.

Ejemplo de la fijación de la tapa sobre el producto.

Example of fixing the lid on the product.

