

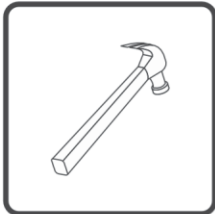

**GUARDA ROUPA
ROMA 6 PORTAS**

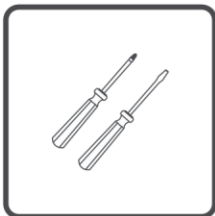

DETALHES IMPORTANTES



Paraf.
3,5x14

Corrediça Telecópica

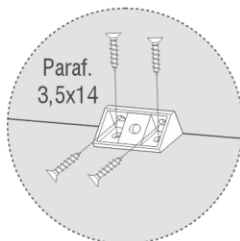

Paraf.
3,5x14

Cantoneira 4 Furos

COMPONENTES		
NUM.	PEÇA	QUANT.
01	LATERAL ESQUERDA	01
02	RODAPÉ MAIOR	02
03	RODAPÉ MENOR	02
04	LATERAL DIREITA	01
05	PÉ	08
06	BASE	01
07	DIVISÃO ESQUERDA	01
08	PRATELEIRA	03
09	PRATELEIRA CENTRAL RECUADA	01
10	TAMPO INTERMEDIÁRIO	01
11	DIVISÃO MALEIRO	04
12	TAMPO SUPERIOR	01
13	VISTA SUPERIOR	01
14	FRENTE GAVETA	03
15	LATERAIS GAVETA	06
16	TRASEIRO GAVETA	03
17	FUNDOS DE GAVETA	03
18	COSTAS	03
19	PORTAS	06
20	DIVISÃO DIREITA	01

ATENÇÃO: EM CASO DE ASSISTÊNCIA, VERIFICAR O NÚMERO DO LOTE DE PRODUÇÃO, NO TOPO DAS PEÇAS E NA ETIQUETA DA CAIXA DO PRODUTO.

RESERVAMO-NOS O DIREITO DE EFETUAR MODIFICAÇÕES TÉCNICAS OU DE MATERIAIS SEM PRÉVIO AVISO.

RELAÇÃO DE FERRAGENS EM TAMANHO REAL (MEDIDA EM MILÍMETRO).



A - PARAF. 3,5x14



B - PARAF. 5x40



C - PARAF. 4,0x25

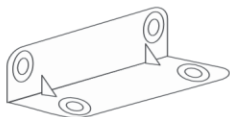

E - CANTONEIRA 4 FUROS



F - SACHÊ DE COLCA



H - FIXADOR DE COSTAS



J - TAMPA ADESIVA

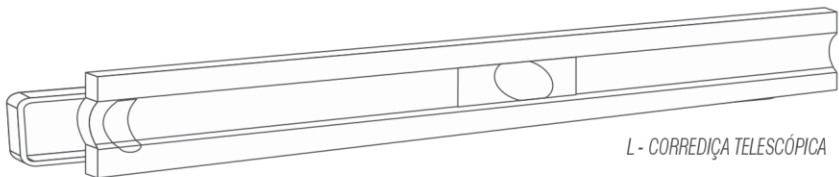

L - CORREDIÇA TELESCÓPICA



M - PUXADOR

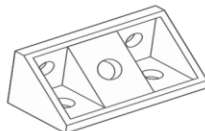

N - CANTONEIRA 4 FUROS

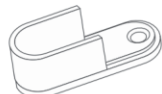

O - SUPORTE CABIDEIRO



P - CABIDEIRO



Q - CAVILHA 6x30



R - PREGO 10x10

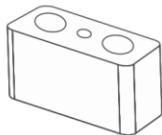

S - ALONGADOR DE CORREDIÇA

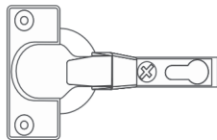

T - DOBRADIÇA

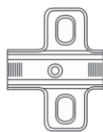

U - CALÇO



V - PARAF. 3,5x20 FLANGEADO

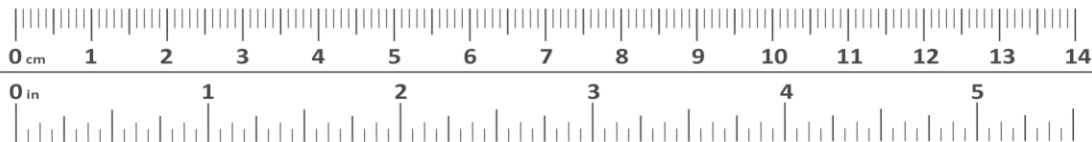

FAVOR IDENTIFICAR AS PEÇAS E COLOCAR SEUS RESPECTIVOS ACESSÓRIOS

Sequência de Montagem

- 01 - Parafusar peças 1 na peça 2.
- 02 - Parafusar peças 3 nos rodapés 2
Observação: Seguir a furação que vai em cima do rodapé 2 para colocação do rodapé 03 tem que ficar alinhado.
- 03 - Parafusar peça 4 nas peças 2;
- 04 - Parafusar os Pés 5 nos rodapés 2.



ATENÇÃO COM OS FUROS
NA PARTE SUPERIOR DA
PEÇA 2 AS PEÇAS 3 TEM QUE
ALINHADOS COM OS MESMOS.



Sequência de Montagem

- 05- Encaixar e Parafuse peça 6 nos rodapés 2 e laterais 1 e 4.
- 06- Encaixar e parafusar peças 7 na peça 6.
- 07- Parafusar peças 8 nas peças 7, 1 e 4.

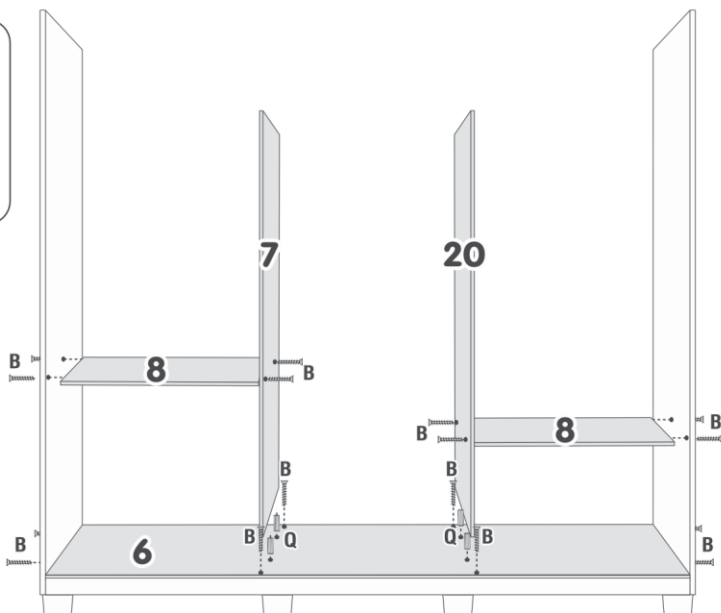
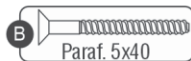

Sequência de Montagem

08 - Encaixar e Parafusar as peças 11 na peças 10;

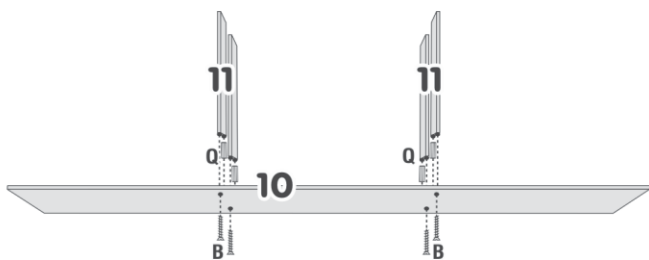
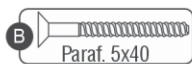

Sequência de Montagem

09 - Parafusar peça 8 nas peças 7;
10 - Parafusar peça 9 nas peças 7;
11 - Encaixar a peça 10 nas peças 7
Parafusar nas peças 1 e 4 em seguida parafusar nas peças 7;

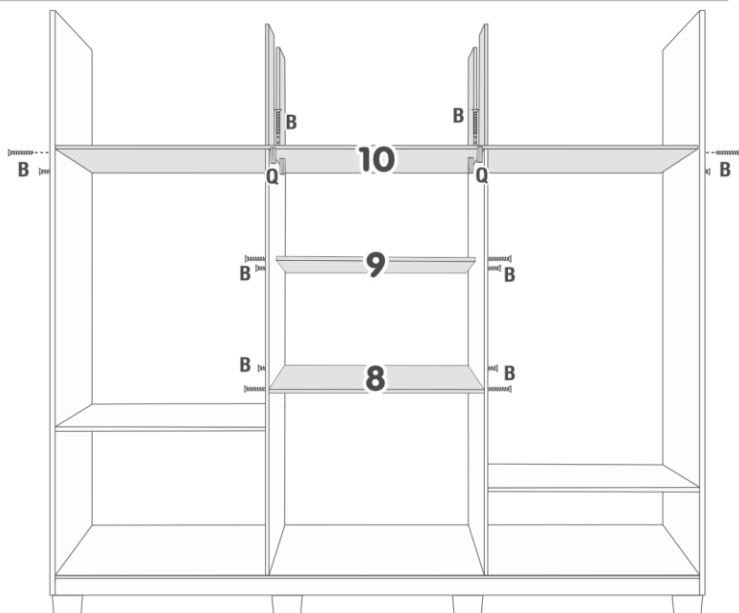
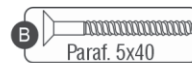

Sequência de Montagem

12 - Encaixar e parafusar peça 12 na peças 01 e 04 e 11.

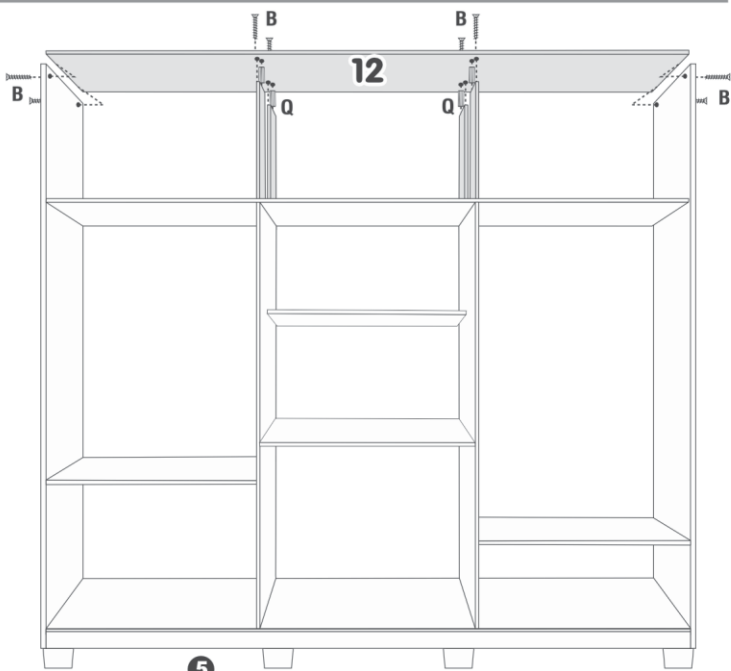

Seqüência de Montagem

- 13 - Fixar peças 13 nas peças 01, 04 e também na peça 12.
14 - Parafusar Alongadores nas peças 07 conforme desenho.

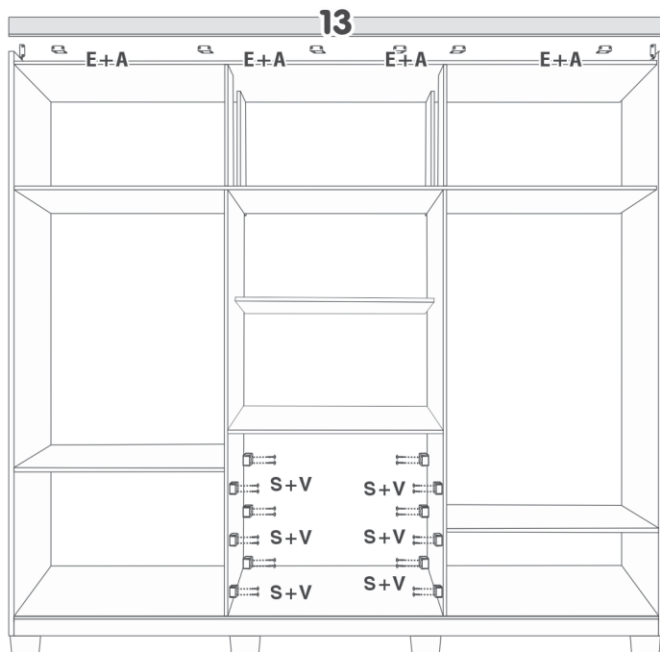

Seqüência de Montagem

- 15 - Montar os cabideiros com os suportes.
16 - Parafusar as corredeiras.

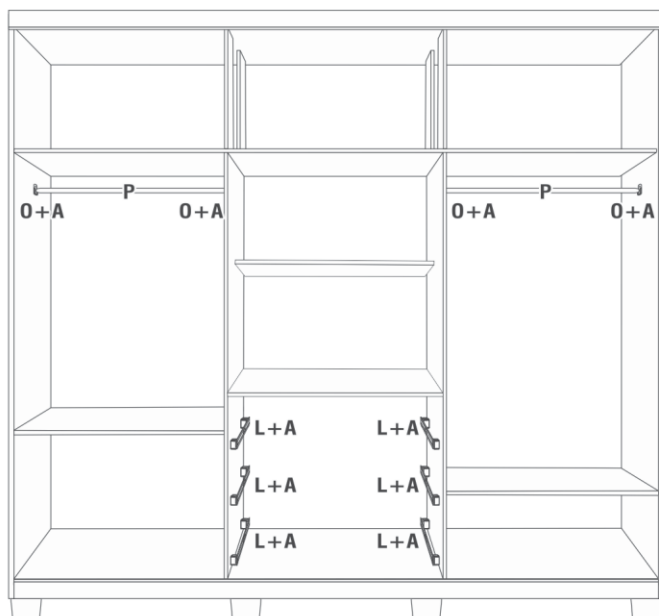

Seqüência de Montagem

17 - Pregiar as Costas 22 conforme desenho ao lado.

OBS.: Acertar as costas para melhor esquadramento do móvel.

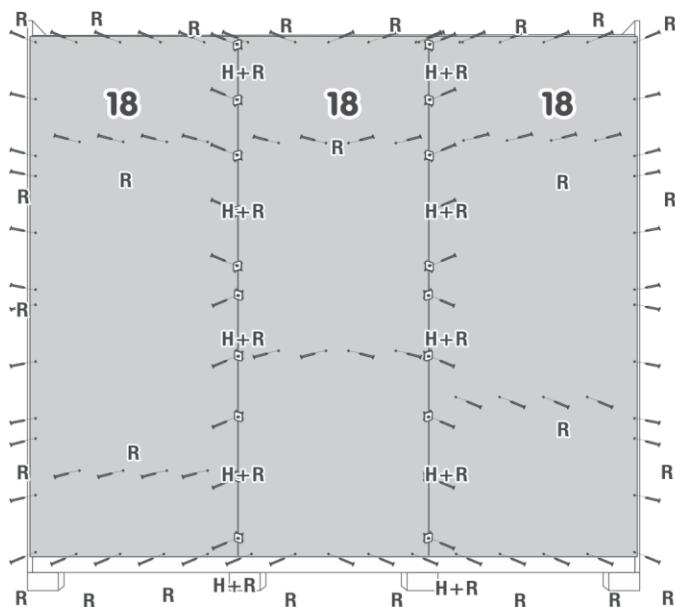
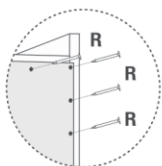

Seqüência de Montagem

18 - Montar e fixar as Portas 19.

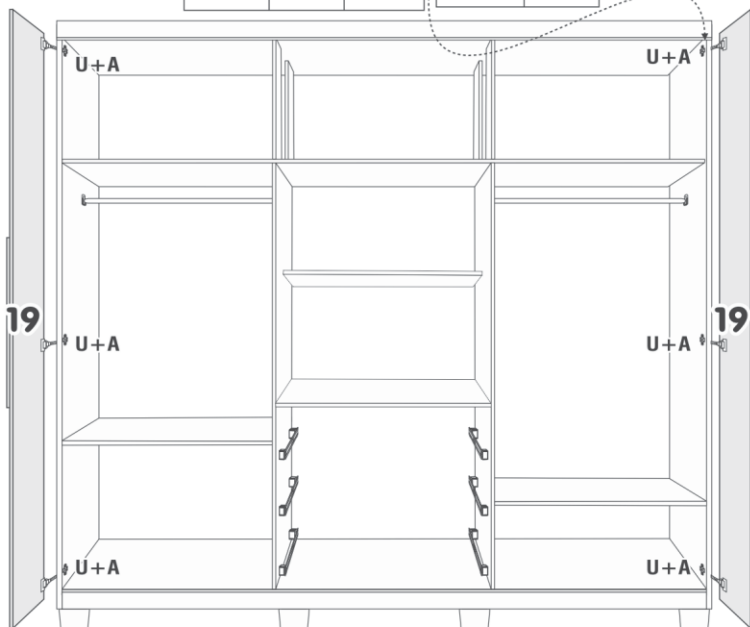
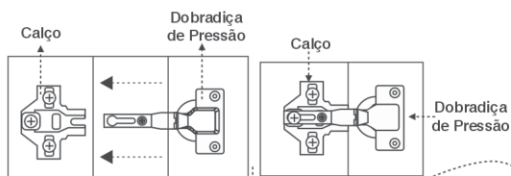
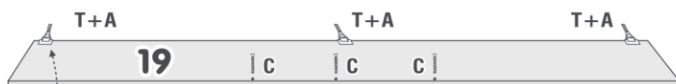
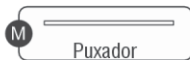
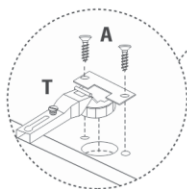

Sequência de Montagem

- 19 - Parafusar as cantoneiras nas peças 15;
- 20 - Parafusar as peças 15 na peça 14 colocando cola nas cavilhas;
- 21 - Parafusar a peça 16 nas peças 15;
- 22 - Parafusar peça 17 nas peças 15 e 16 conforme desenho abaixo, ajustando para melhor esquadramento da gaveta;
- 23 - Parafusar as corredeiras na lateral da peça 15;

