



**GUARDA ROUPA
ROMA 6 PORTAS**

RELAÇÃO DE FERRAGENS EM TAMANHO REAL (MEDIDA EM MILÍMETRO).



A - PARAF. 3,5x14



B - PARAF. 5x40



C - PARAF. 4,0x25

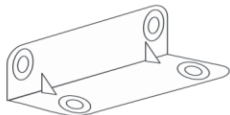

E - CANTONEIRA 4 FUROS



F - SACHÊ DE COLCA

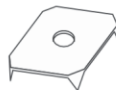

H - FIXADOR DE COSTAS



J - TAMP ADESIVA

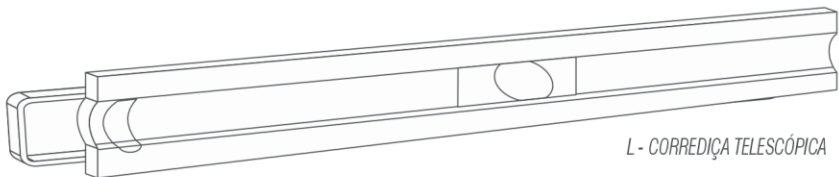

L - CORREDIÇA TELESCÓPICA



M - PUXADOR

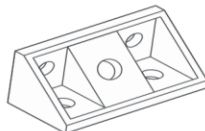

N - CANTONEIRA 4 FUROS

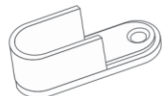

O - SUPORTE CABIDEIRO

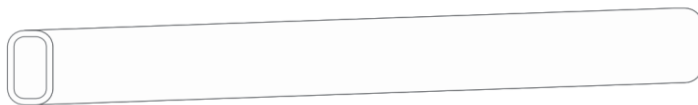

P - CABIDEIRO



Q - CAVILHA 6x30



R - PREGO 10x10

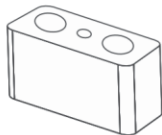

S - ALONGADOR DE CORREDIÇA

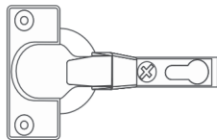

T - DOBRADIÇA

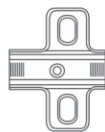

U - CALÇO



V - PARAF. 3,5x20 FLANGEADO

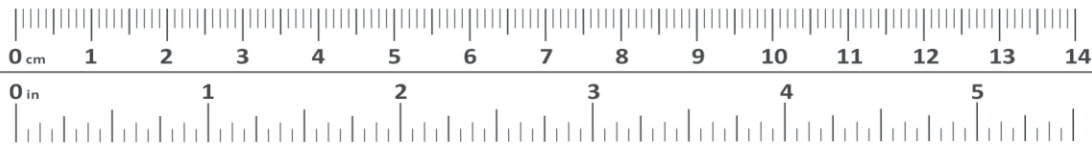

FAVOR IDENTIFICAR AS PEÇAS E COLOCAR SEUS RESPECTIVOS ACESSÓRIOS

Sequência de Montagem

- 01 - Parafusar peças 1 na peça 2.
- 02 - Parafusar peças 3 nos rodapés 2
Observação: Seguir a furação que vai em cima do rodapé 2 para colocação do rodapé 03 tem que ficar alinhado.
- 03 - Parafusar peça 4 nas peças 2;
- 04 - Parafusar os Pés 5 nos rodapés 2.



ATENÇÃO COM OS FUROS
NA PARTE SUPERIOR DA
PEÇA 2 AS PEÇAS 3 TEM QUE
ALINHADOS COM OS MESMOS.



Sequência de Montagem

- 05- Encaixar e Parafuse peça 6 nos rodapés 2 e laterais 1 e 4.
- 06- Encaixar e parafusar peças 7 na peça 6.
- 07- Parafusar peças 8 nas peças 7, 1 e 4.

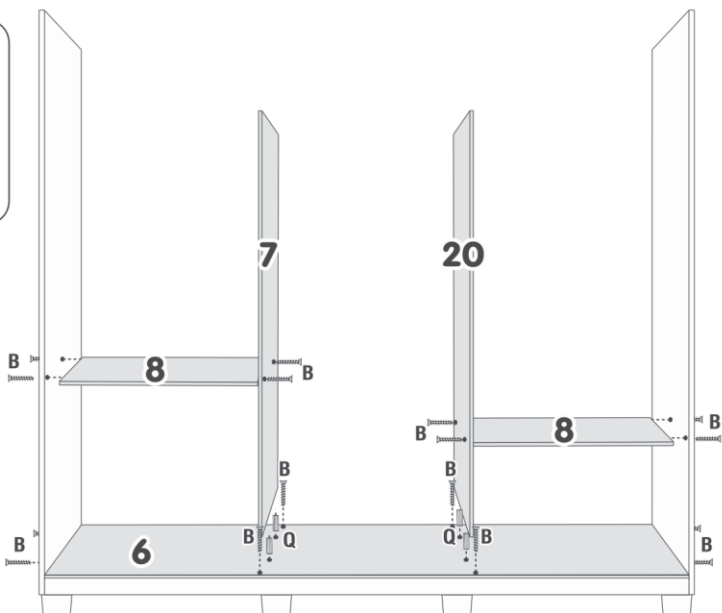
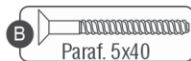

Sequência de Montagem

08 - Encaixar e Parafusar as peças 11 na peças 10;

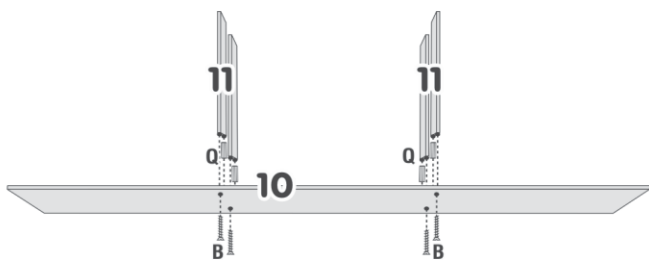

Sequência de Montagem

09 - Parafusar peça 8 nas peças 7;
10 - Parafusar peça 9 nas peças 7;
11 - Encaixar a peça 10 nas peças 7
Parafusar nas peças 1 e 4 em
seguida parafusar nas peças 7;

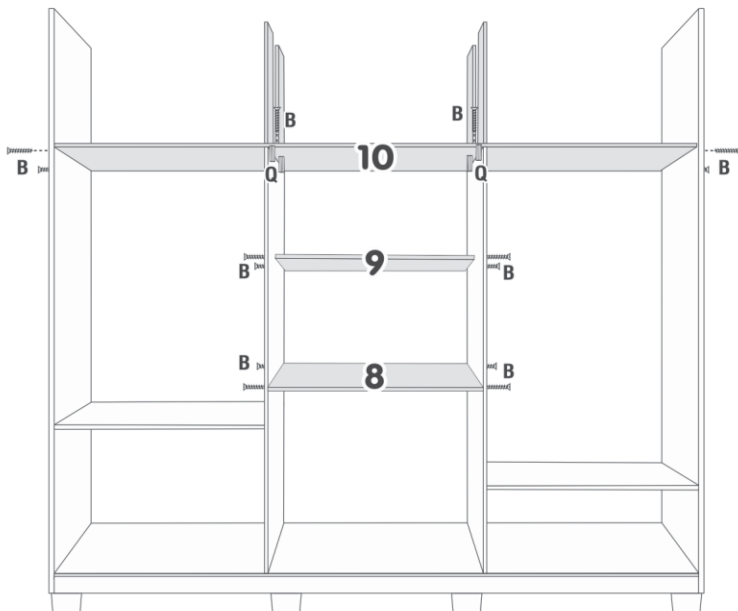
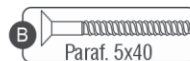

Sequência de Montagem

12 - Encaixar e parafusar peça 12
na peças 01 e 04 e 11.

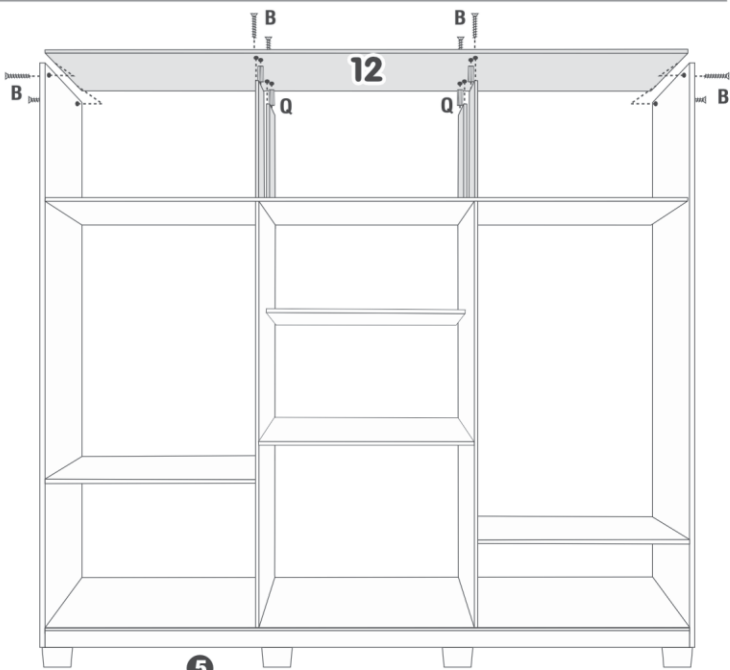

Seqüência de Montagem

- 13 - Fixar peças 13 nas peças 01, 04 e também na peça 12.
14 - Parafusar Alongadores nas peças 07 conforme desenho.

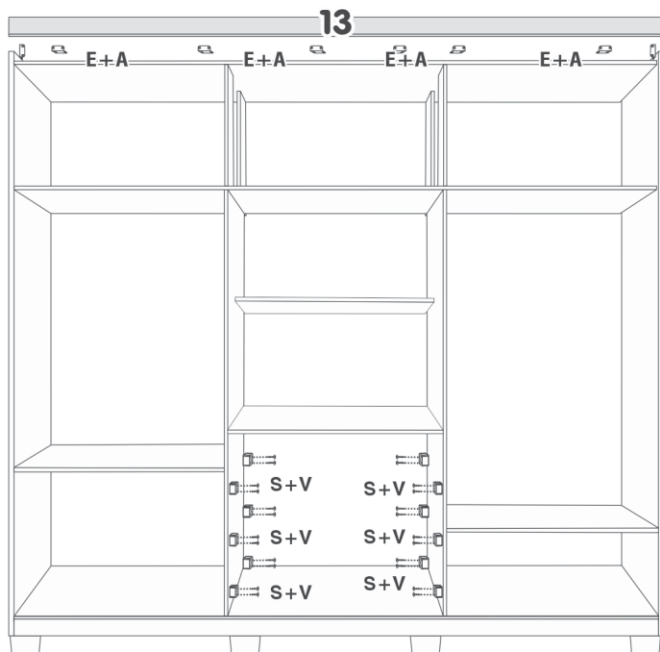

Seqüência de Montagem

- 15 - Montar os cabideiros com os suportes.
16 - Parafusar as corredeiras.

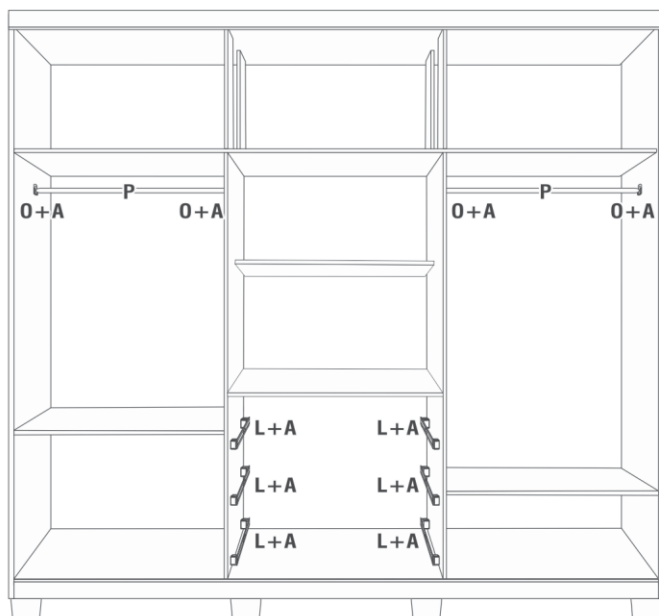

Seqüência de Montagem

17 - Pregiar as Costas 22 conforme desenho ao lado.

OBS.: Acertar as costas para melhor esquadramento do móvel.

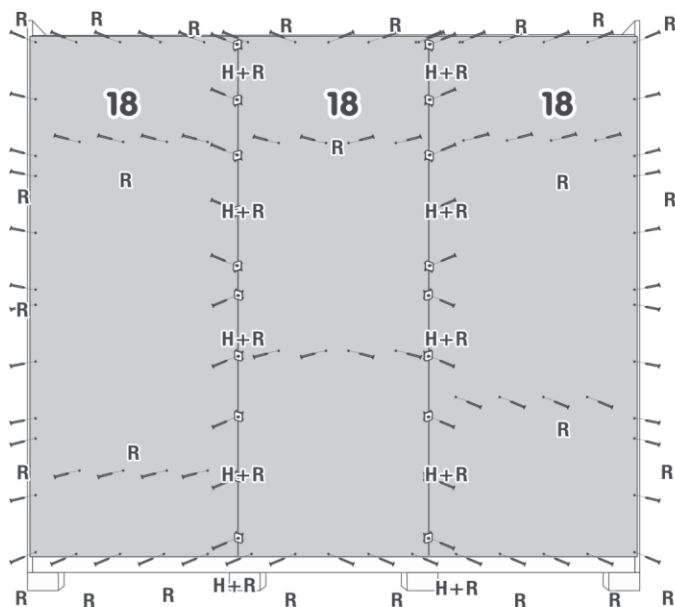
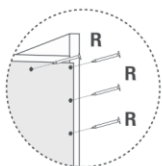

Seqüência de Montagem

18 - Montar e fixar as Portas 19.

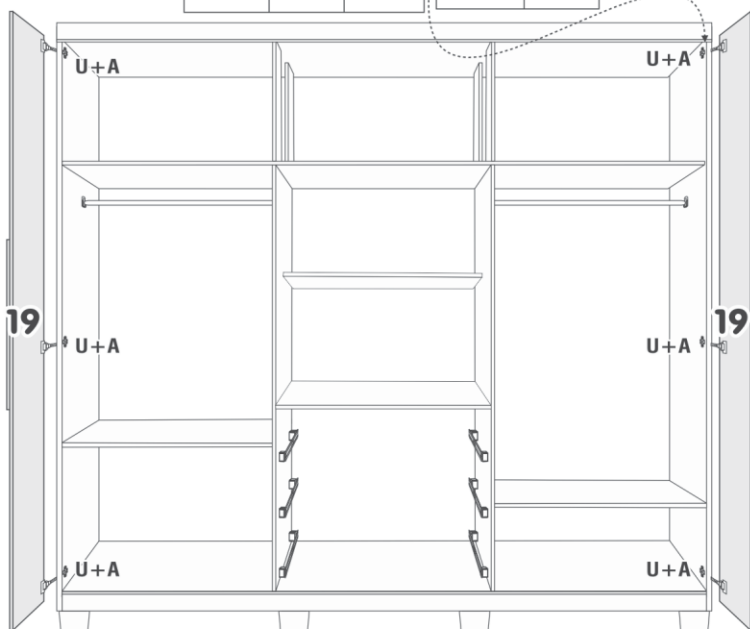
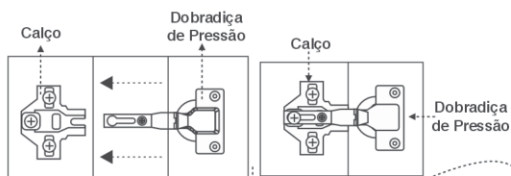
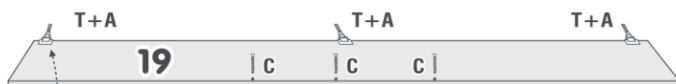
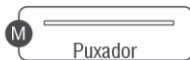
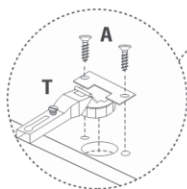

Sequência de Montagem

- 19 - Parafusar as cantoneiras nas peças 15;
- 20 - Parafusar as peças 15 na peça 14 colocando cola nas cavilhas;
- 21 - Parafusar a peça 16 nas peças 15;
- 22 - Parafusar peça 17 nas peças 15 e 16 conforme desenho abaixo, ajustando para melhor esquadramento da gaveta;
- 23 - Parafusar as corredeiras na lateral da peça 15;

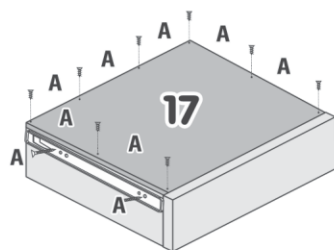
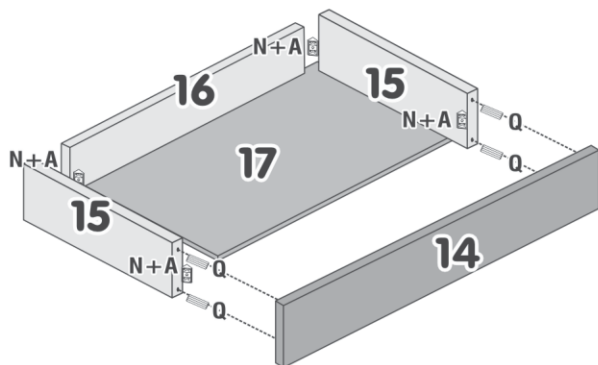

Agora que você já comprou o seu móvel, ele merece ser montado do jeito certo.

Erros de montagem causam mais de **60%** dos danos em móveis.

Por que contratar?

Tranquilidade do **início ao fim** da montagem



PROFISSIONAIS QUALIFICADOS

Especialistas certificados na **MadeiraMadeira Serviços**.



FERRAMENTAS PROFISSIONAIS

que **protegem** seus móveis.



AGENDAMENTO EM 24 HORAS

escolha a data e o turno **ideais para** você.



GARANTIA DE 3 MESES

de cobertura **completa**.

Mais de 1 MILHÃO DE MONTAGENS
★ com avaliação 4.7 ★

Mariana S., São Paulo

"Chegaram no horário e montaram tudo rapidamente. Serviço incrível!"



Carlos R., Belo Horizonte

"Tentei montar sozinho e foi um desastre. Com a **MadeiraMadeira Serviços** ficou perfeito."



Ana P., Rio de Janeiro

"Agendamento ágil e **montagem pontual e perfeita**. Recomendo demais!"



Agende agora pelo
QR Code

Madeira**Madeira** Serviços · Atendimento em todo o Brasil



Escaneie o QRCode