



***ROUPEIRO PARIS 6 PORTAS  
4 GAVETAS***

**MONTAGEM DOS PÉS OPCIONAIS**



# RELAÇÃO DE FERRAGENS EM TAMANHO REAL (MEDIDA EM MILÍMETRO).

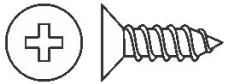

A - PARAF. 3,5x14

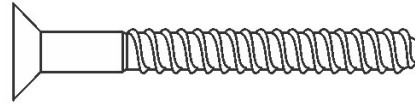

B - PARAF. 5x40

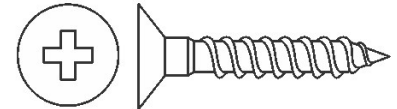

C - PARAF. 4,0x25

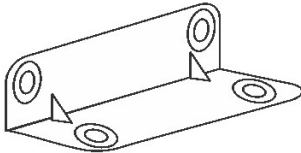

D - CANTONEIRA 4 FUROS

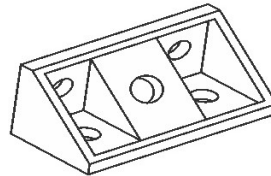

E - CANTONEIRA 4 FUROS

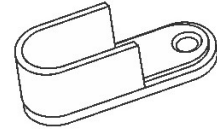

F - SUPORTE CABIDEIRO

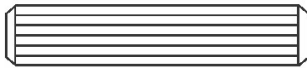

G - CAVILHA 6x30

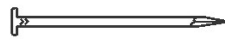

H - PREGO 10x10

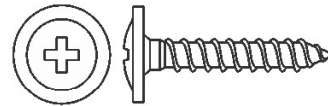

I - PARAF. 3,5x20 FLANGEADO

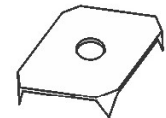

J - FIXADOR DE COSTAS

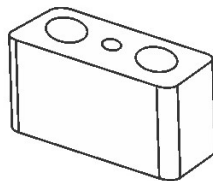

K - ALONGADOR DE CORREDIÇA



M - PUXADOR

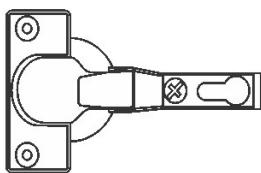

N - DOBRADIÇA

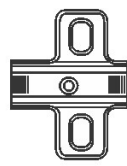

O - CALÇO

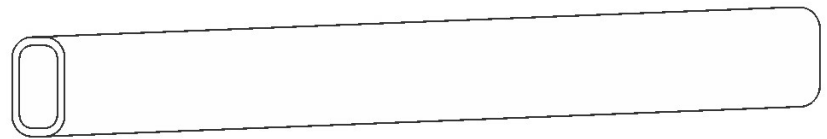

P - CABIDEIRO

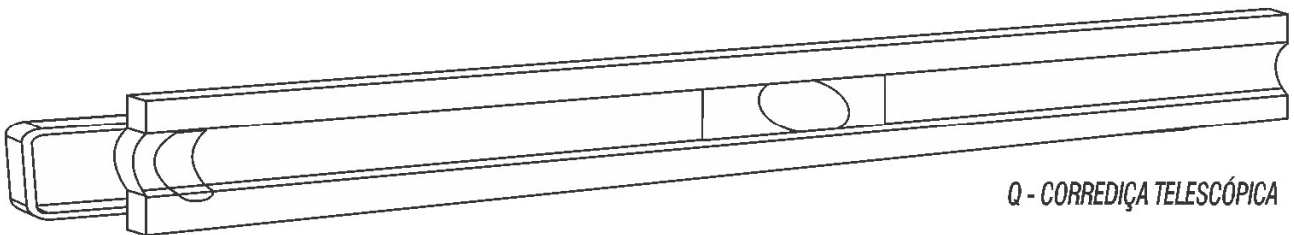

Q - CORREDIÇA TELESCÓPICA



# FAVOR IDENTIFICAR AS PEÇAS E COLOCAR SEUS RESPECTIVOS ACESSÓRIOS

## Sequência de Montagem

- 01 - Parafusar peças 2 nas peça 3;
- 02 - Parafusar peça 1 nas 2;
- 03 - Parafusar peça 4 nas peças 2;
- 04 - Parafusar os Pés 19 nos rodapés 2.

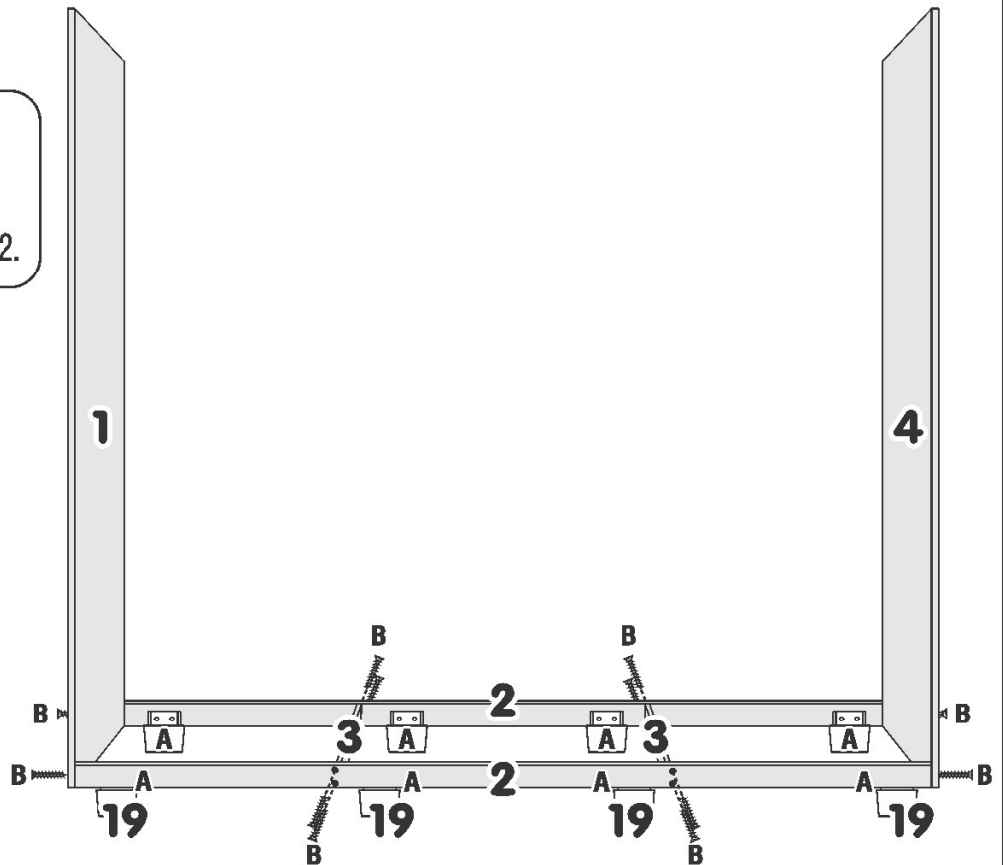
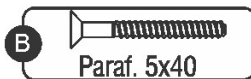

## Sequência de Montagem

- 05- Parafusar peça 5 nas peças 2;
- 06- Encaixar as peça 6 e 7 na peça 5 conforme desenho.

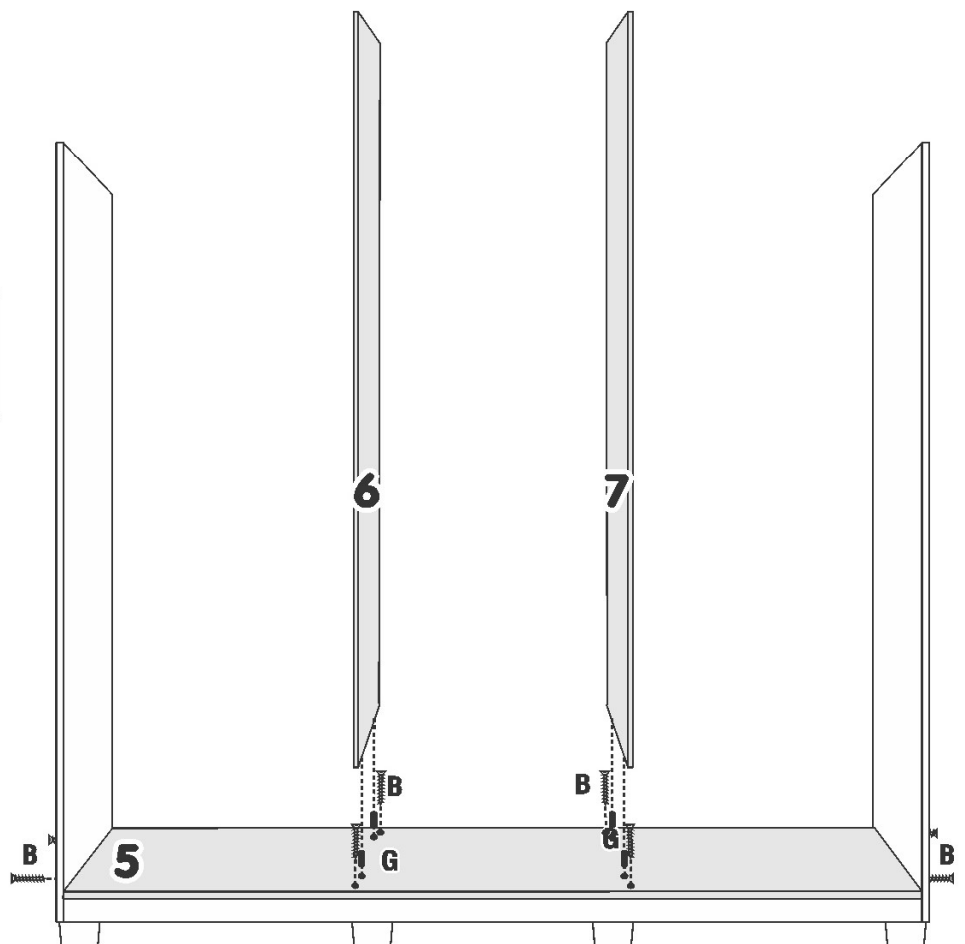
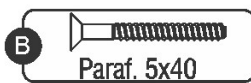

### Sequência de Montagem

07 - Parafusar peça 8 conforme desenho.

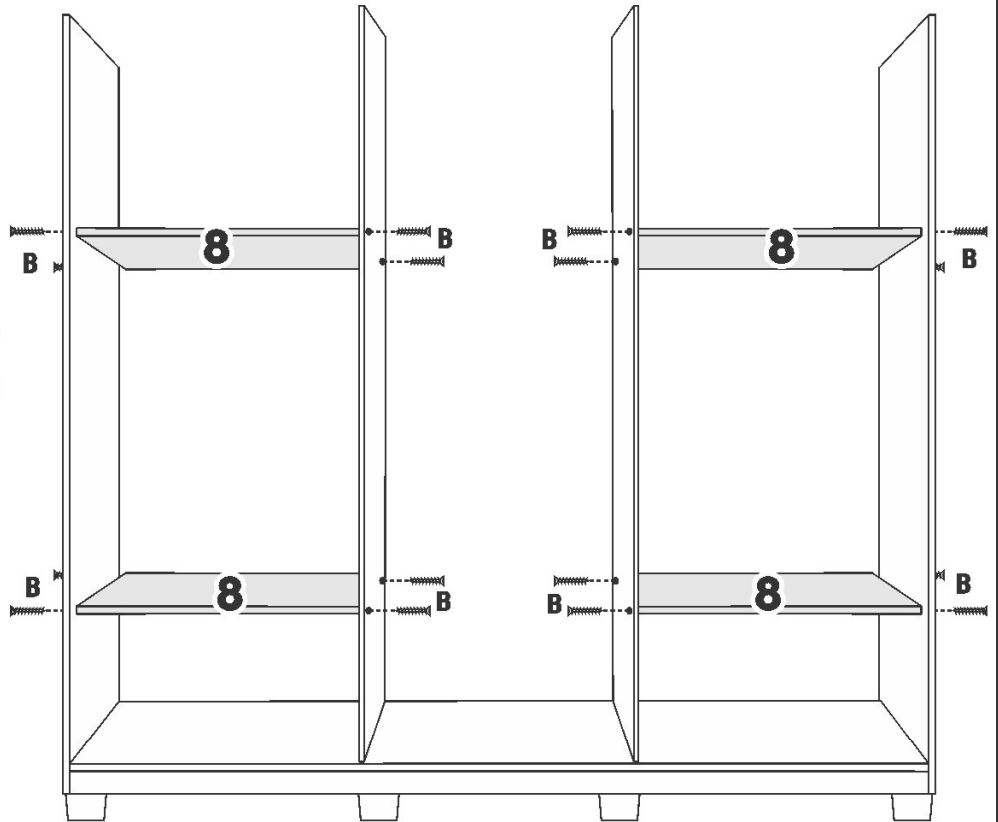
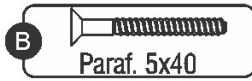

### Sequência de Montagem

08- Parafusar peça 8 Superior central e encaixar a peça 8 lateral conforme desenho.

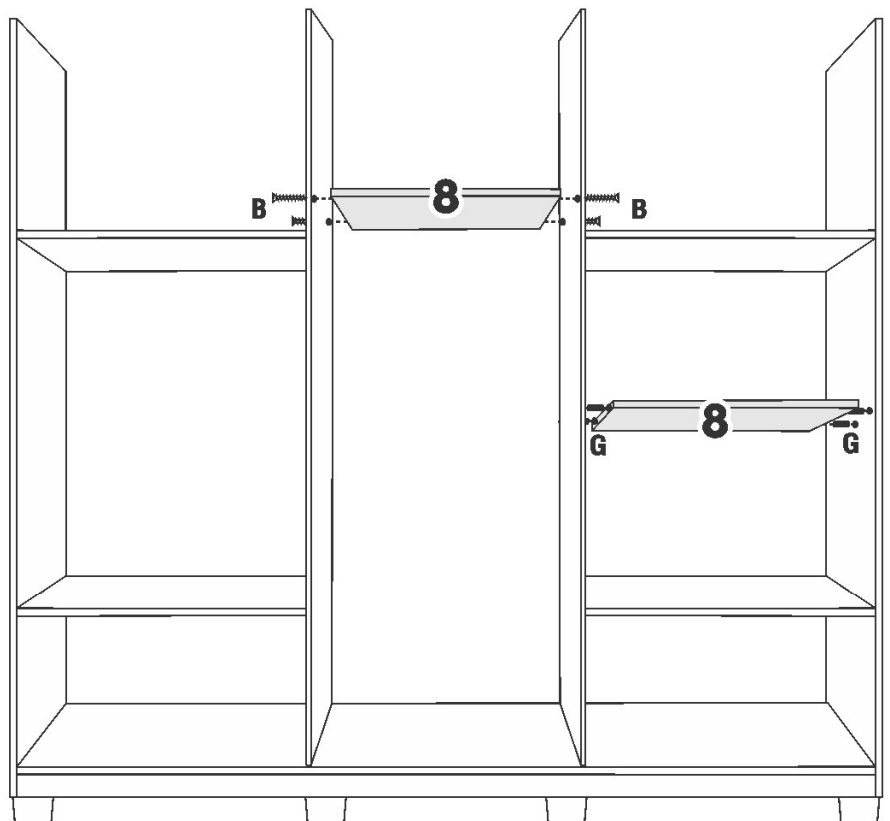
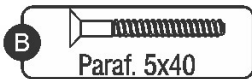

### Sequência de Montagem

- 09 - Parafusar a peça 20 nas peças 1, 4, 6, e 7.
- 10 - Parafusar a Alongador de corredeira nas peças 1, 4, 6, e 7 conforme desenho.

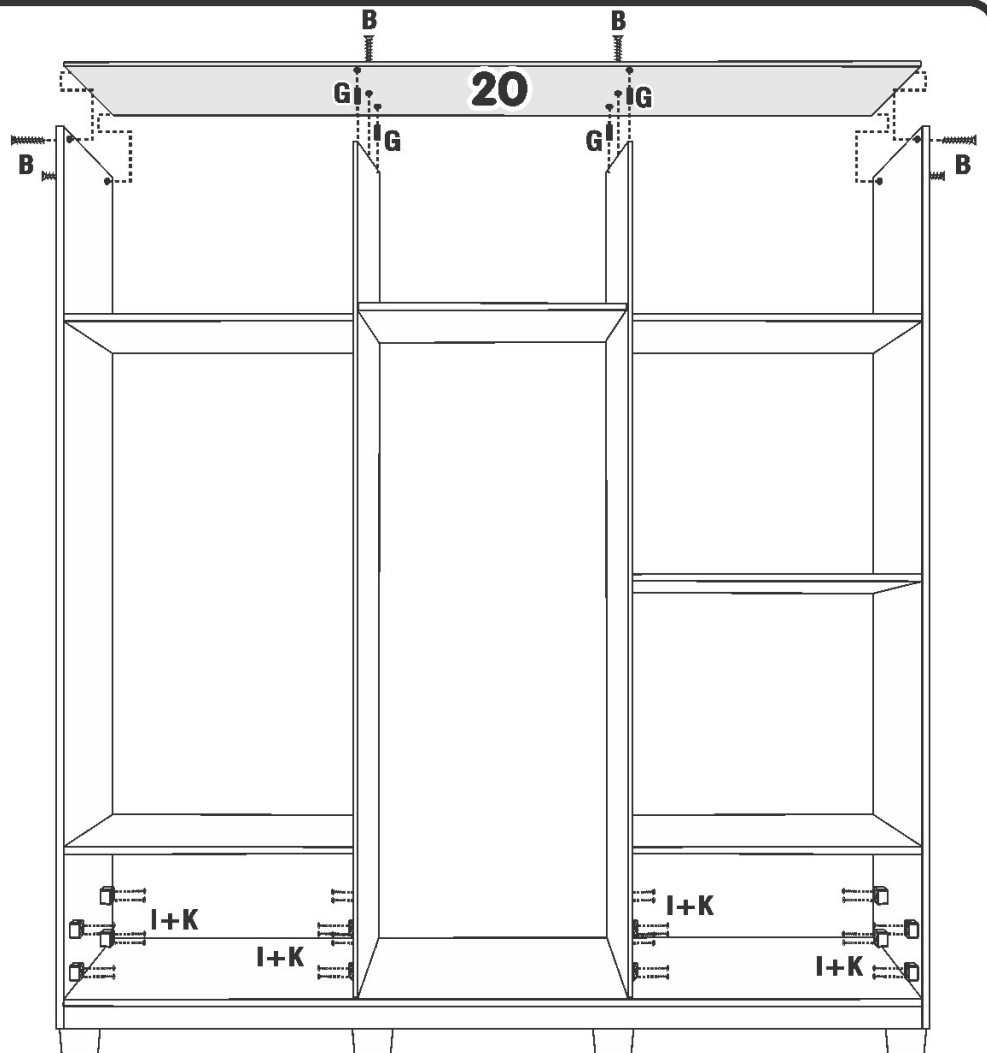
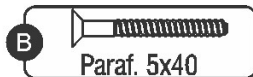

### Sequência de Montagem

- 11 - Parafusar a peça 12 nas peças 1, 4, 5 e 20;
- 12 - Parafusar as corredeiras nos alongadores, **ATENÇÃO: CADA CORREDEIRA TEM SEU RESPECTIVO PAR;**
- 13 - Parafusar suporte de cabideiro conforme desenho ao lado.

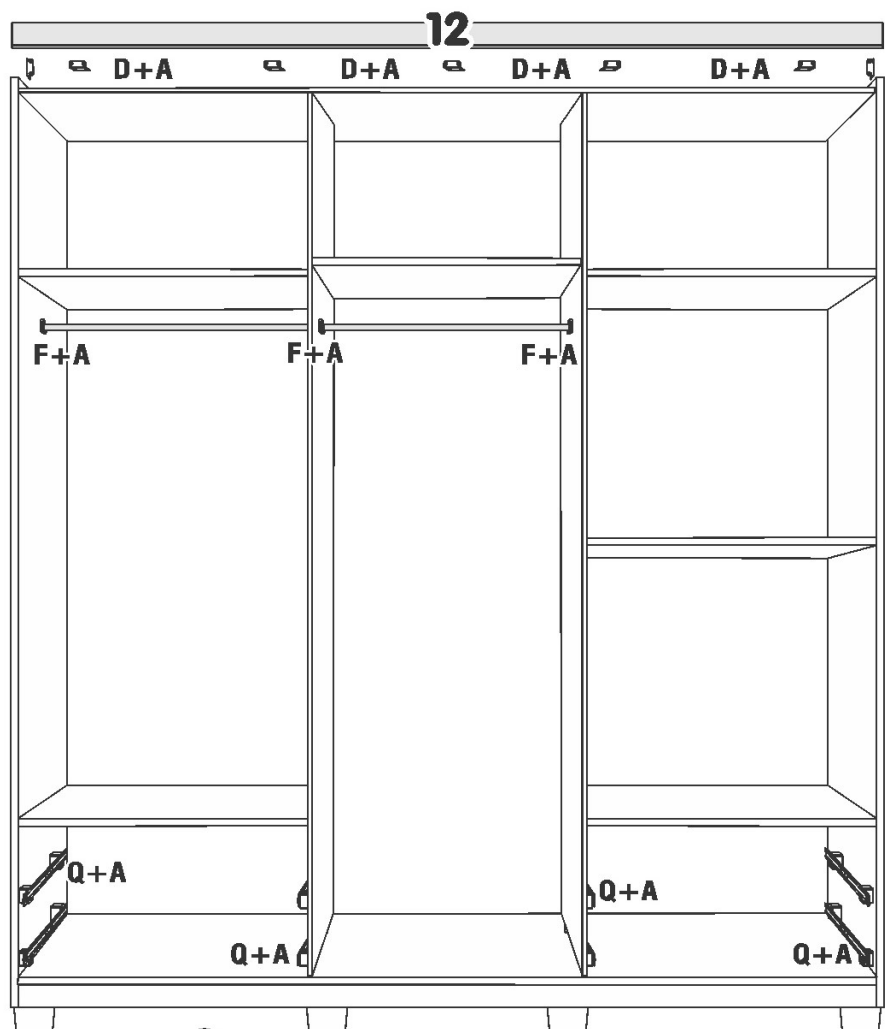
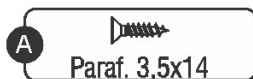

### Sequência de Montagem

14 - Pregiar as Costas 14 conforme desenho ao alado.

**OBS.:** Acertar as costas para melhor esquadramento do móvel.

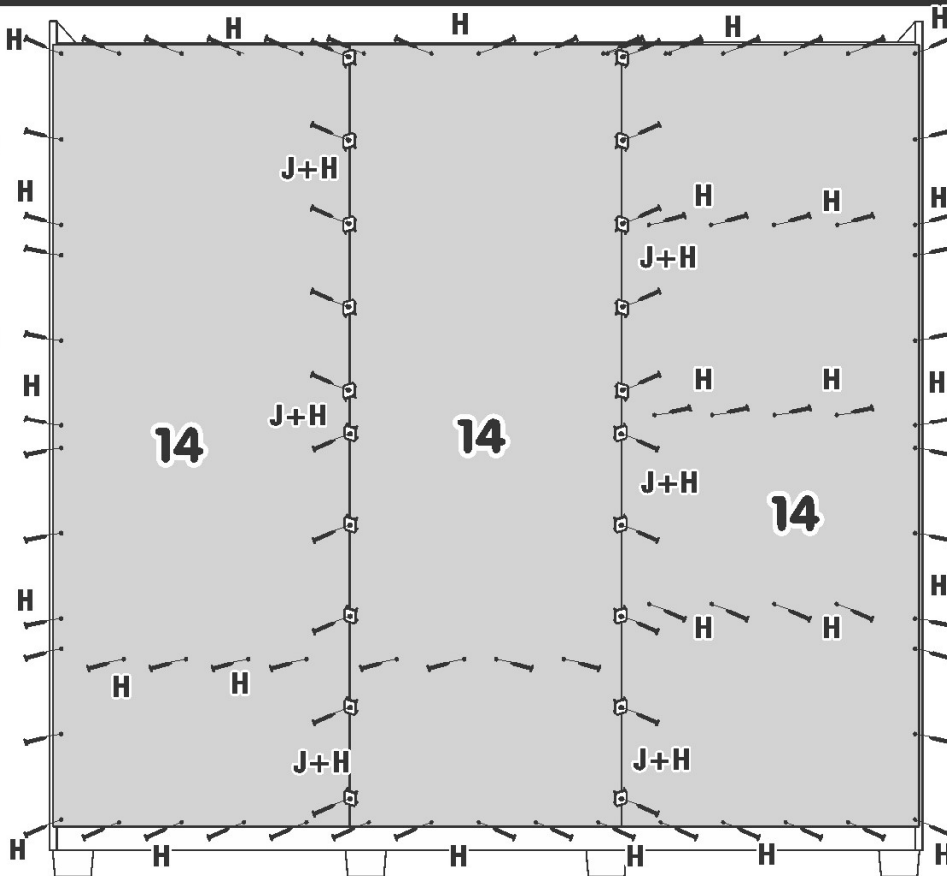

### Sequência de Montagem

15 - Montar e fixar as Portas 13.

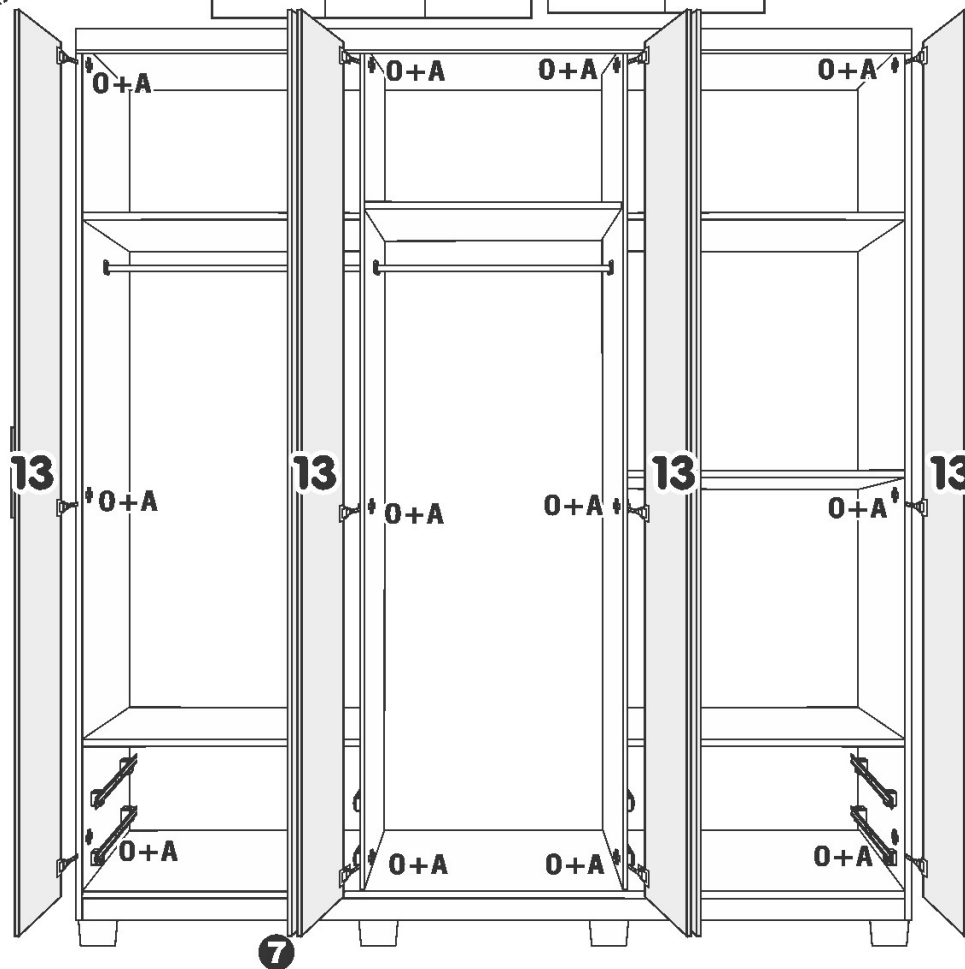
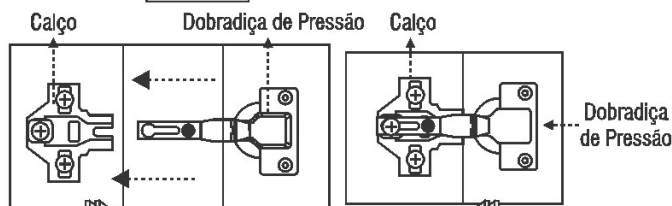
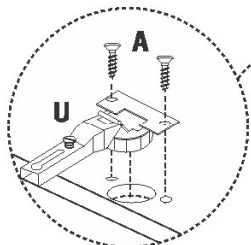

## Sequência de Montagem

- 16 - Parafusar as cantoneiras nas peças 16;
- 17 - Parafusar as peças 16 nas peças 15;
- 18 - Parafusar a peça 17 nas peças 16;
- 19 - Parafusar peça 18 nas peças 16 e 17 conforme desenho abaixo, ajustando para melhor esquadramento da Gaveta;
- 20 - Parafusar as corredeiras nas laterais da peça 16.

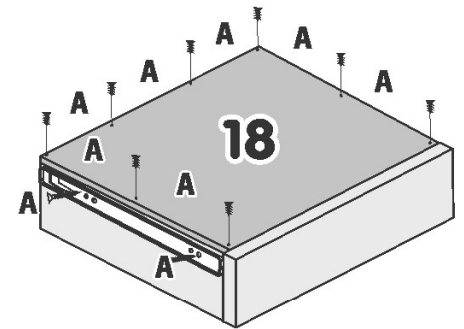
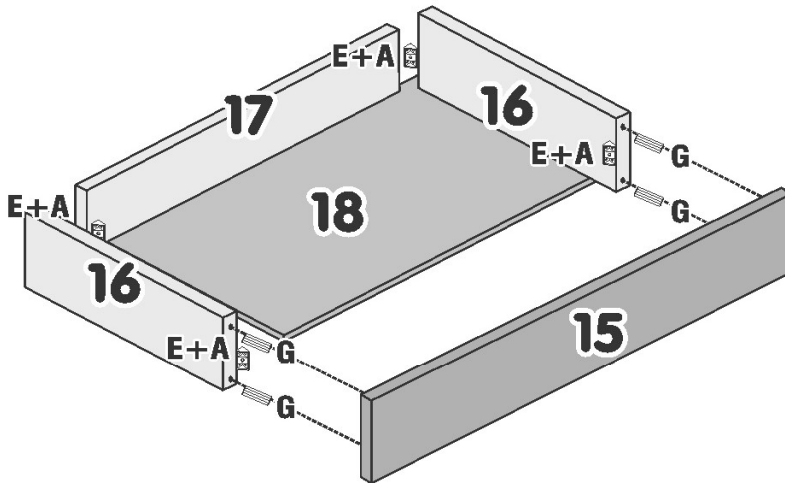



# ESQUEMA MONTAGEM SUPORTE FUNDO DE GAVETA



Paraf. 3,5x14



Suporte  
Fundo  
Gaveta

