



ROUPEIRO FLORENÇA 3 PORTAS

MONTAGEM DE PÉS OPCIONAL

RELAÇÃO DE FERRAGENS EM TAMANHO REAL (MEDIDA EM MILÍMETRO).



A - PARAF. 5x40

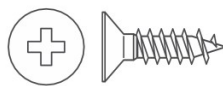

B - PARAF. 3,5x14

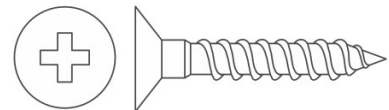

C - PARAF. 4,0x25



D - TAMPA ADESIVA



E - CAVILHA 6x30



F - FIXADOR DE COSTAS



G - PREGO 10x10

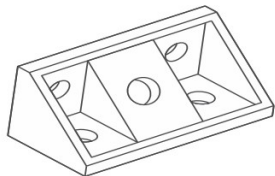

H - CANTONEIRA 4 FUROS

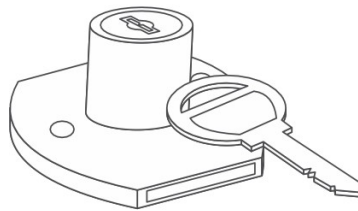

I - FECHADURA C/ CHAVE

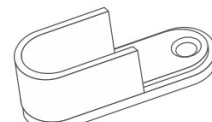

J - SUPORTE CABIDEIRO

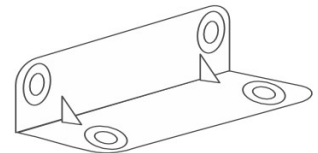

K - CANTONEIRA 4 FUROS

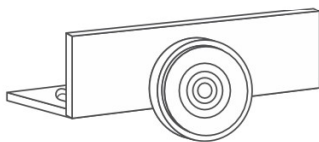

L - KIT ROLDANA

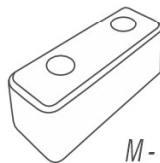

M - BATENTE

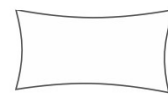

O - SACHÊ DE COLCA



N - CABIDEIRO

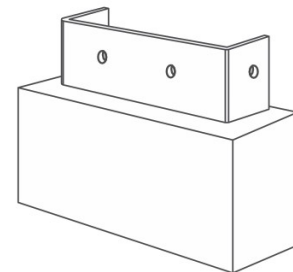

T - PÉS

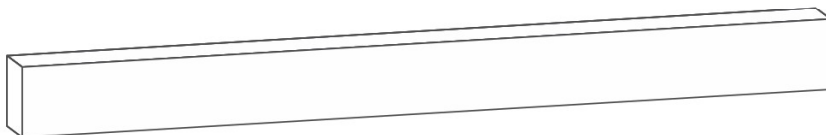

P - PUXADOR

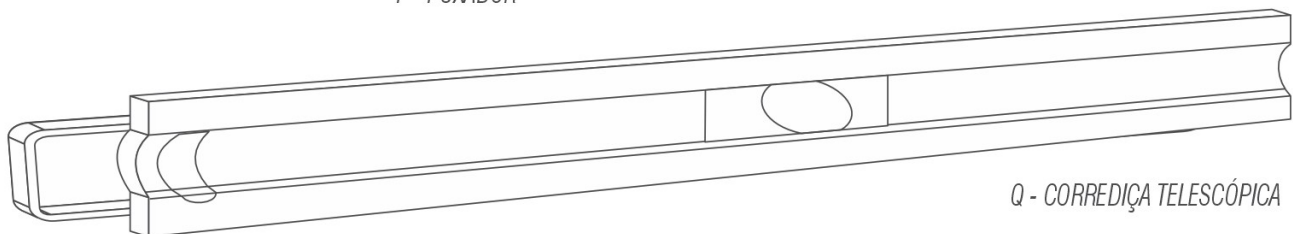

Q - CORREDIÇA TELESCÓPICA



R - TRILHO METÁLICO INFERIOR

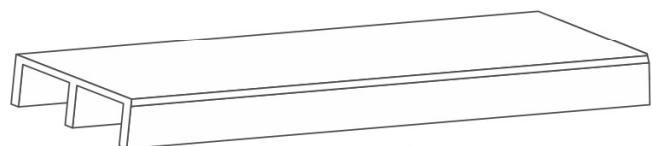

S - TRILHO PLÁSTICO SUPERIOR

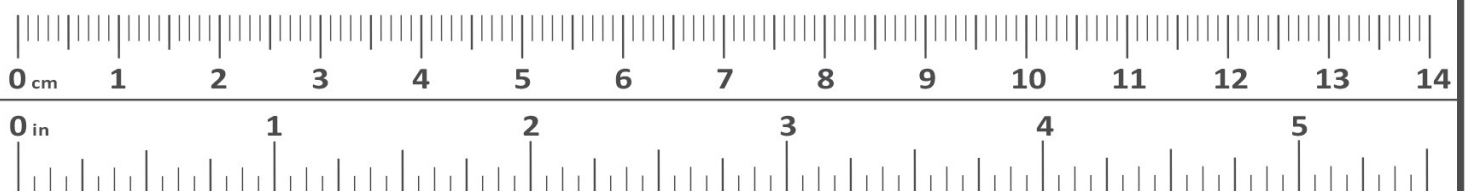

FAVOR IDENTIFICAR AS PEÇAS E COLOCAR SEUS RESPECTIVOS ACESSÓRIOS

Sequência de Montagem

- 01 - Parafusar peças 02 na peça 03;
- 02 - Fixar corredeças nas peça 01 e 04;
- 03 - Parafusar peça 01 e 04 nas peças 02.

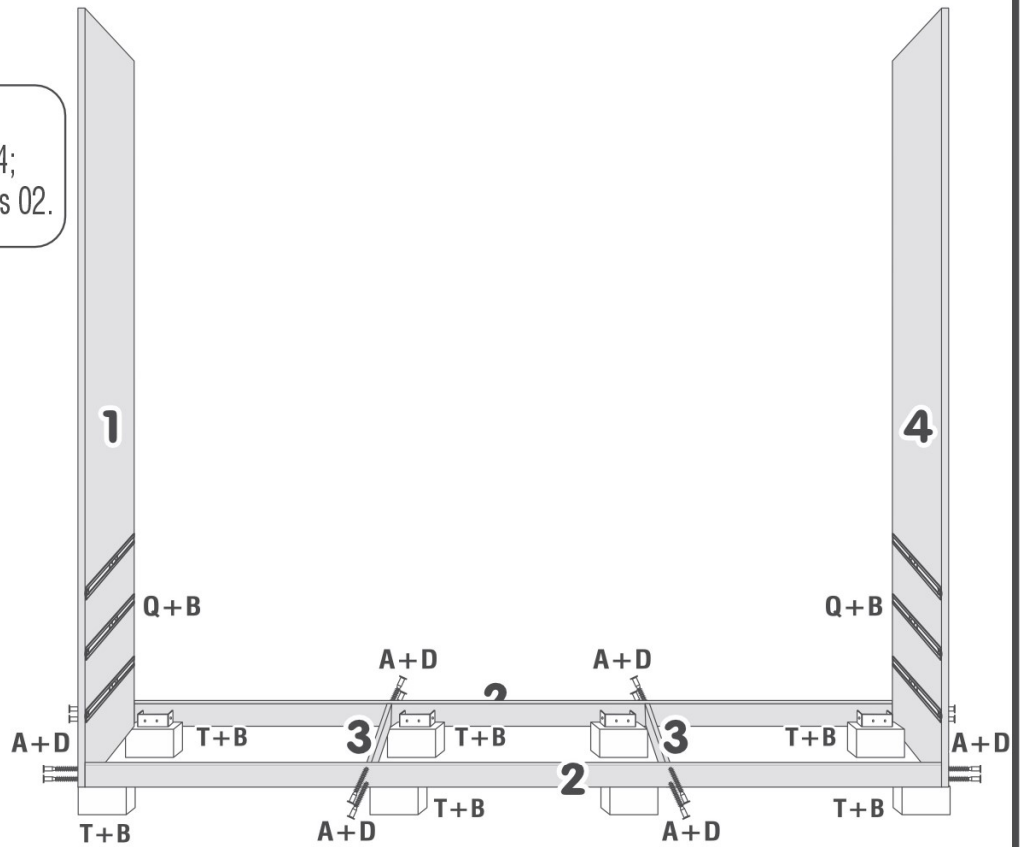
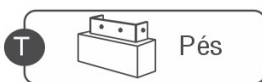
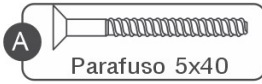

Sequência de Montagem

- 04 - Parafusar corredeças nas peças 05;
- 05 - Encaixar as peças 5 nas peças 2.

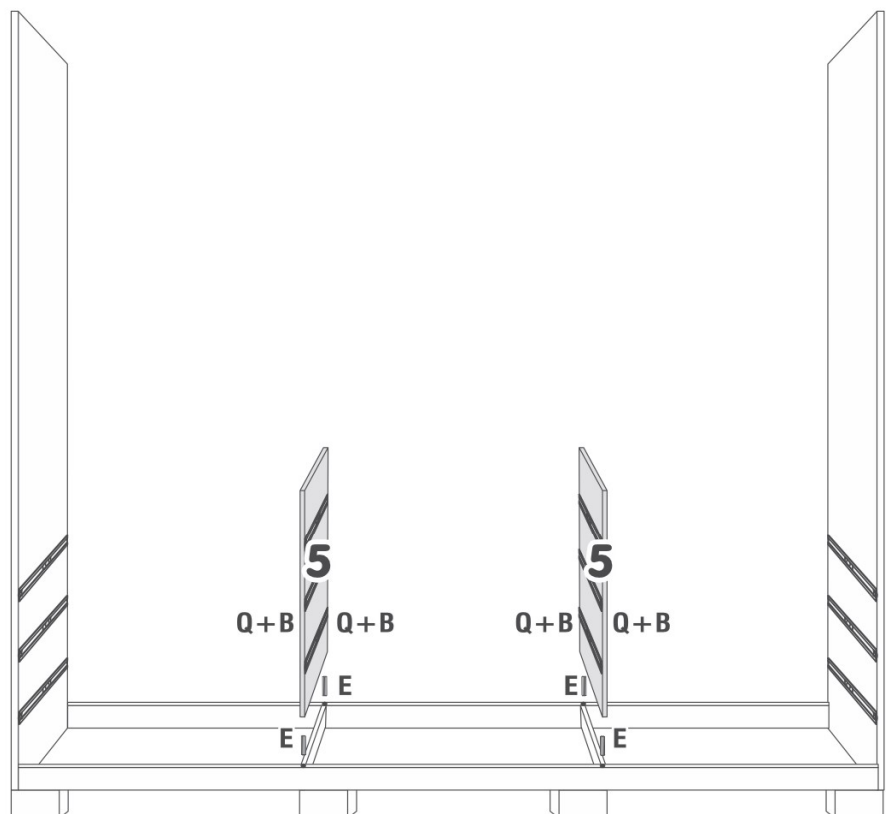

Sequência de Montagem

- 06 - Encaixar e parafusar peças 06 nas divisões 05 e nas laterais 01 e 04;
 07 - Encaixa a peça 08 nas peça 06;
 08 - Parafusar as peças 7 nas peças 01 e 08;
 09 - Parafusar as peças 7 nas peças 04 e 08.

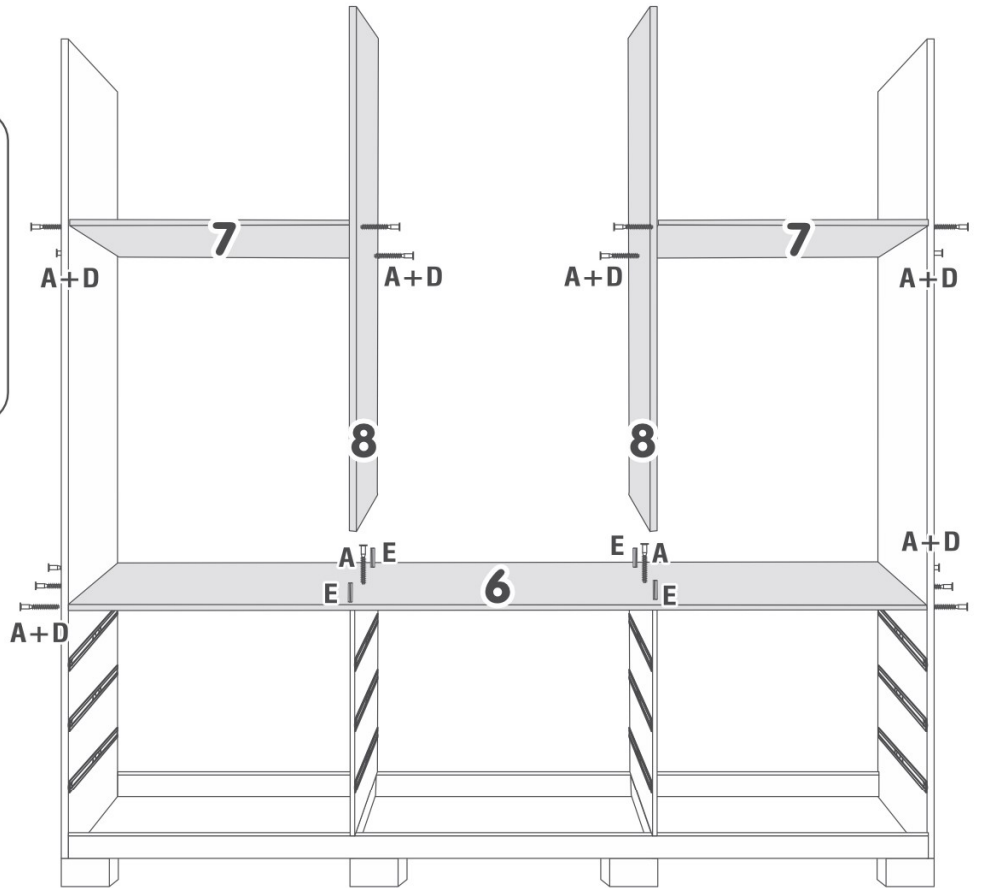
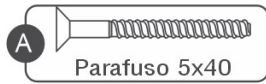

Sequência de Montagem

- 10 - Parafusar as peças 7 nas peças 08;
 11 - Parafusar peça 09 nas peças 01, 04 e 08;
 12 - Parafusar peça 10 nas peças 01, 04 e 09.

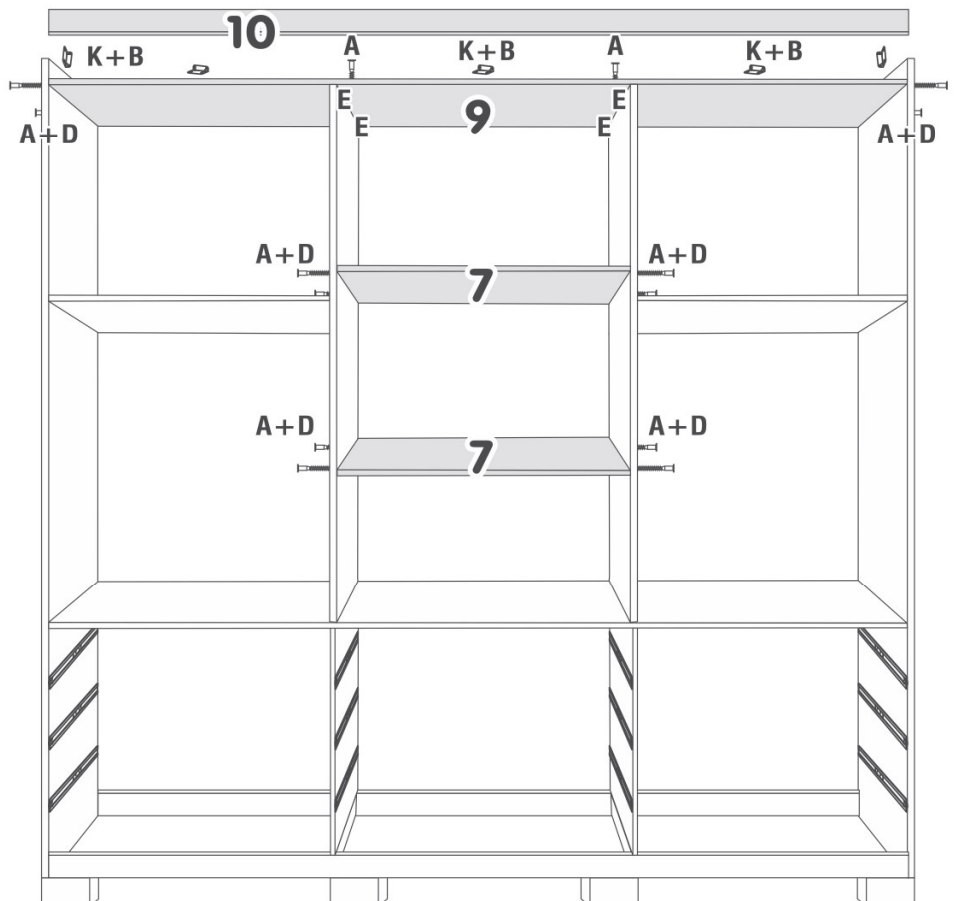

Sequência de Montagem

- 13 - Parafusar as cantoneiras plásticas nas peças 16;
- 14 - Parafusar as peças 16 na peça 15 colocando cola nas cavilhas;
- 15 - Parafusar a peça 17 nas peças 16;
- 16 - Parafusar peça 18 nas peças 16 e 17 conforme desenho abaixo, ajustando para melhor esquadramento da gaveta;
- 17 - Parafusar as corredeças na lateral da peça 16;
- 18 - Parafusar a peça 19 nas peças 16 e 17.

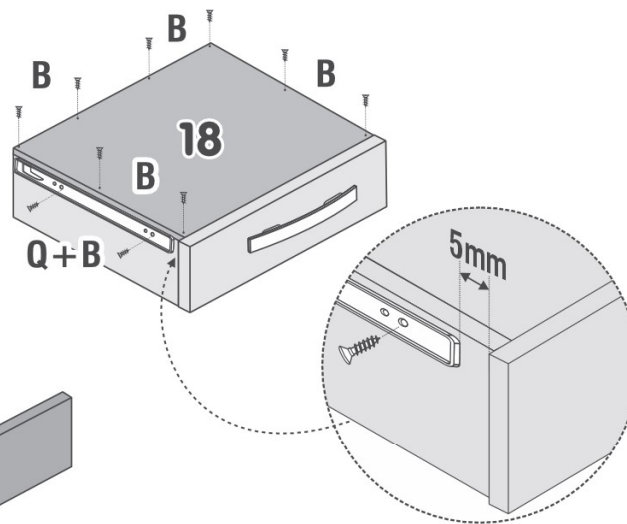
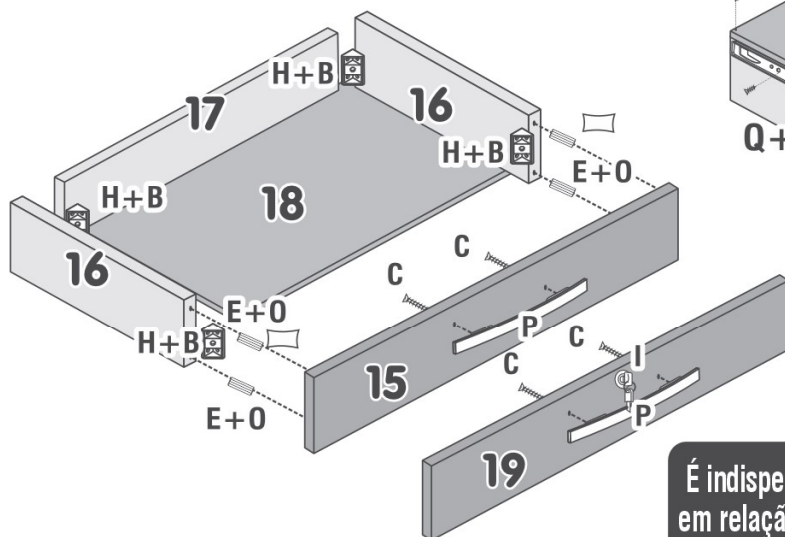
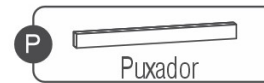

É indispensável fixar a corredeça na lateral, com recuo de 5 mm em relação a frente da gaveta, para acionar a trava da corredeça.

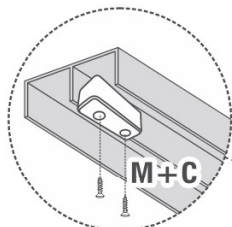

ATENÇÃO: USAR BATENTE (M+C) NA CALHA DA PORTA CENTRAL COM ESPELHO, EVITANDO QUE A MESMA BATA NOS PUXADORES DAS PORTAS LATERAIS EVITANDO DANIFICÁ-LOS.

Sequência de Montagem

- 19 - Parafusar o batente da portas 22 nas laterais 01 e 04;
- 20 - Parafusar trilho superior na peça 09;
- 21 - Parafusar trilho inferior de metal na peças 06;
- 22 - Parafusar Suporte Cabideiro;
- 23 - Colocar Cabideiros conforme desenho ao lado.

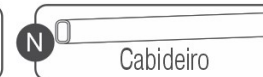
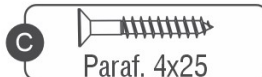
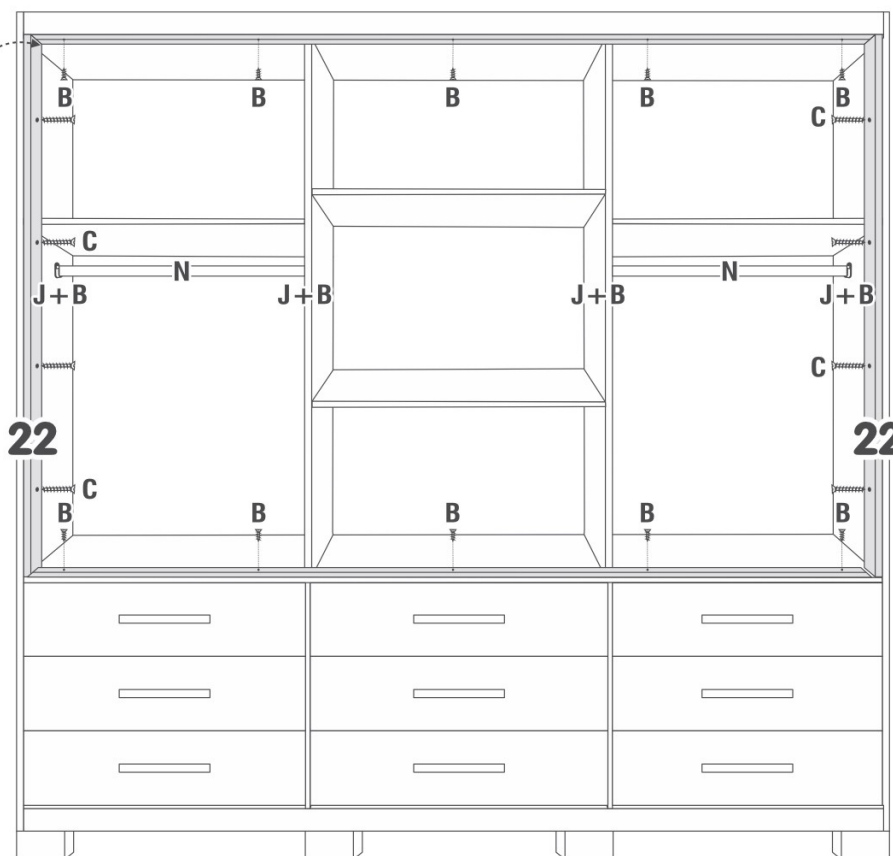

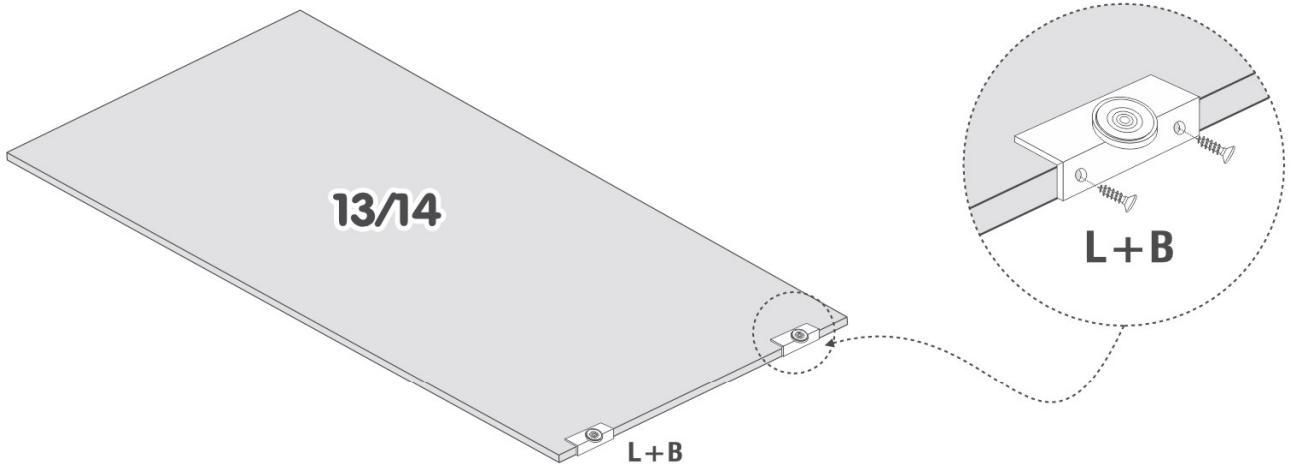

Sequência de Montagem

24 - Parafusar o kit roldana nas portas 13 e 14, encaixar as mesmas nos trilhos para fazer os ajustes finais.



ATENÇÃO: ESPELHO VENDIDO SEPARADAMENTE



Sequência de Montagem

25 - Pregiar as Costas 20 e 21, conforme desenho para sustentação do móvel.

OBS.: Acertar as costas para melhor esquadramento do móvel.

