

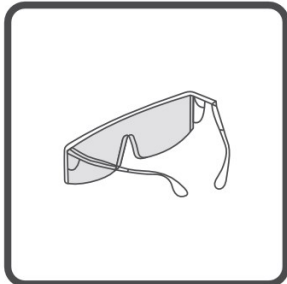

---

***ROUPEIRO ROMA 6PTAS***

***MONTAGEM DO KIT PÉS OPCIONAL***

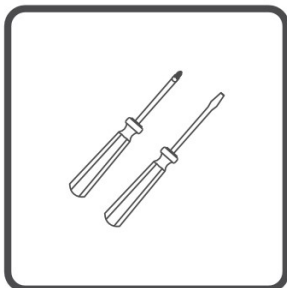

32 3539.5350  
www.benetil.com.br

## DETALHES IMPORTANTES



Corrediça Telecópica

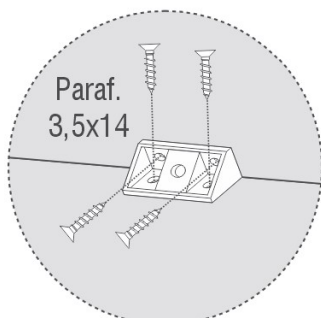

Cantoneira 4 Furos

COMPONENTES		
NUM.	PEÇA	QUANT.
01	LATERAL ESQUERDA	01
02	RODAPÉ MAIOR	02
03	RODAPÉ MENOR	02
04	LATERAL DIREITA	01
05	PÉ	08
06	BASE	01
07	DIVISÃO DIREITA	01
08	PRATELEIRA GAVETEIRO	02
09	PRATELEIRA CENTRAL INFERIOR	01
10	PRATELEIRA CENTRAL SUPERIOR	01
11	DIVISÃO DO NINCHO	01
12	PRAT. NINCHO	02
13	TAMPO INTERMEDIÁRIO	01
14	DIVISÃO DO MALEIRO	02
15	TAMPO SUPERIOR	01
16	VISTA SUPERIOR	01
18	FRENTE GAVETA	04
19	LATERAIS GAVETA	08
20	TRASEIRO GAVETA	04
21	FUNDOS DE GAVETA	04
22	COSTAS	03
24	PORTAS	06
25	DIVISÃO ESQUERDA	01

**ATENÇÃO: EM CASO DE ASSISTÊNCIA, VERIFICAR O NÚMERO DO LOTE DE PRODUÇÃO, NO TOPO DAS PEÇAS E NA ETIQUETA DA CAIXA DO PRODUTO.**

**RESERVAMO-NOS O DIREITO DE EFETUAR MODIFICAÇÕES TÉCNICAS OU DE MATERIAIS SEM PRÉVIO AVISO.**

# RELAÇÃO DE FERRAGENS EM TAMANHO REAL (MEDIDA EM MILÍMETRO).



A - PARAF. 3,5x14

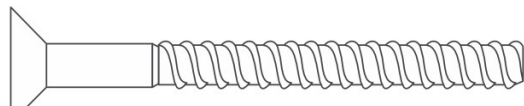

B - PARAF. 5x40 SEM PONTA

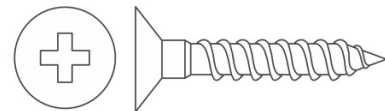

C - PARAF. 4,0x25

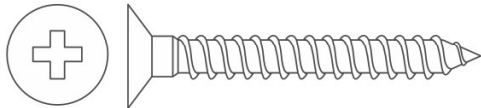

D - PARAF. 4,0x35

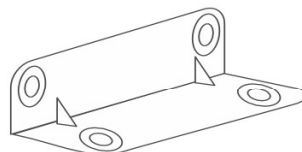

E - CANTONEIRA 4 FUROS



F - SACHÊ DE COLCA

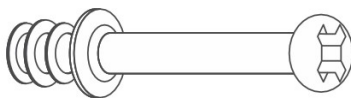

G - MINIFIX SIMPLES

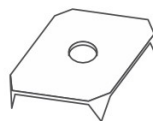

H - FIXADOR DE COSTAS



I - TAMBOR MINIFIX



J - TAMPA ADESIVA

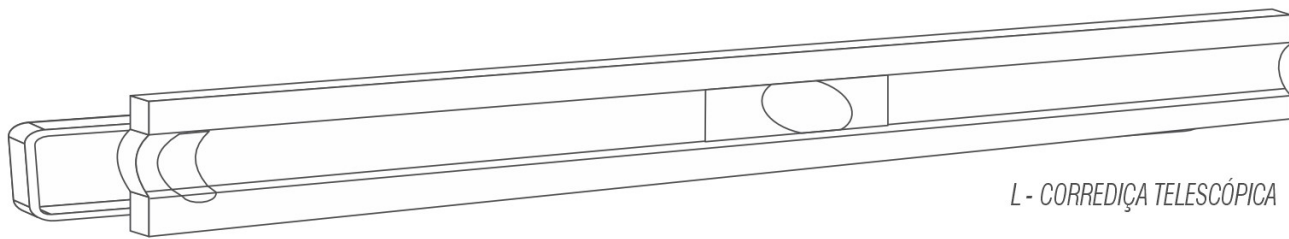

L - CORREDIÇA TELESCÓPICA

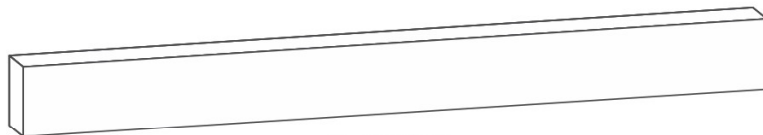

M - PUXADOR

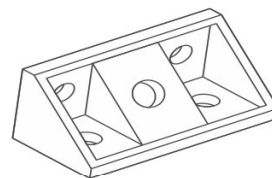

N - CANTONEIRA 4 FUROS

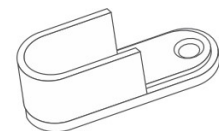

O - SUPORTE CABIDEIRO



P - CABIDEIRO

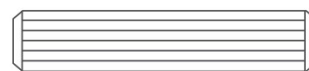

Q - CAVILHA 6x30



R - PREGO 10x10

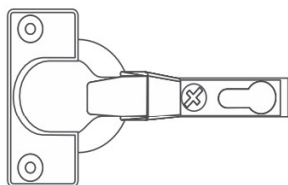

T - DOBRADIÇA

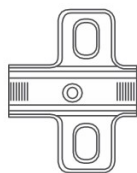

U - CALÇO

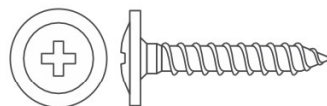

V - PARAF. 3,5x20 FLANGEADO

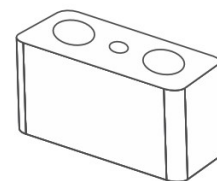

W - ALONGADOR DE CORREDIÇA



# FAVOR IDENTIFICAR AS PEÇAS E COLOCAR SEUS RESPECTIVOS ACESSÓRIOS

## Sequência de Montagem

- 01 - Parafusar peças 1 na peça 2.
- 02 - Parafusar peças 3 nos rodapés 2  
Observação: Seguir a furação que vai em cima do rodapé 2 para colocação do rodapé 03 tem que ficar alinhado.
- 03 - Parafusar peça 4 nas peças 2;
- 04 - Parafusar os Pés 5 nos rodapés 2.

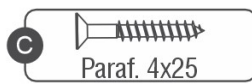
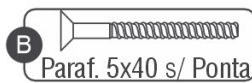

ATENÇÃO COM OS FUROS NA PARTE SUPERIOR DA PEÇA 2 AS PEÇAS 3 TEM QUE ALINHADOS COM OS MESMOS.



## Sequência de Montagem

- 05- Encaixar e Parafuse peça 6 nos rodapés 2 e laterais 1 e 4.
- 06- Encaixar e parafusar peças 7 e 25 na peça 6.
- 07- Parafusar peças 8 nas peças 7, 25, 1 e 4.

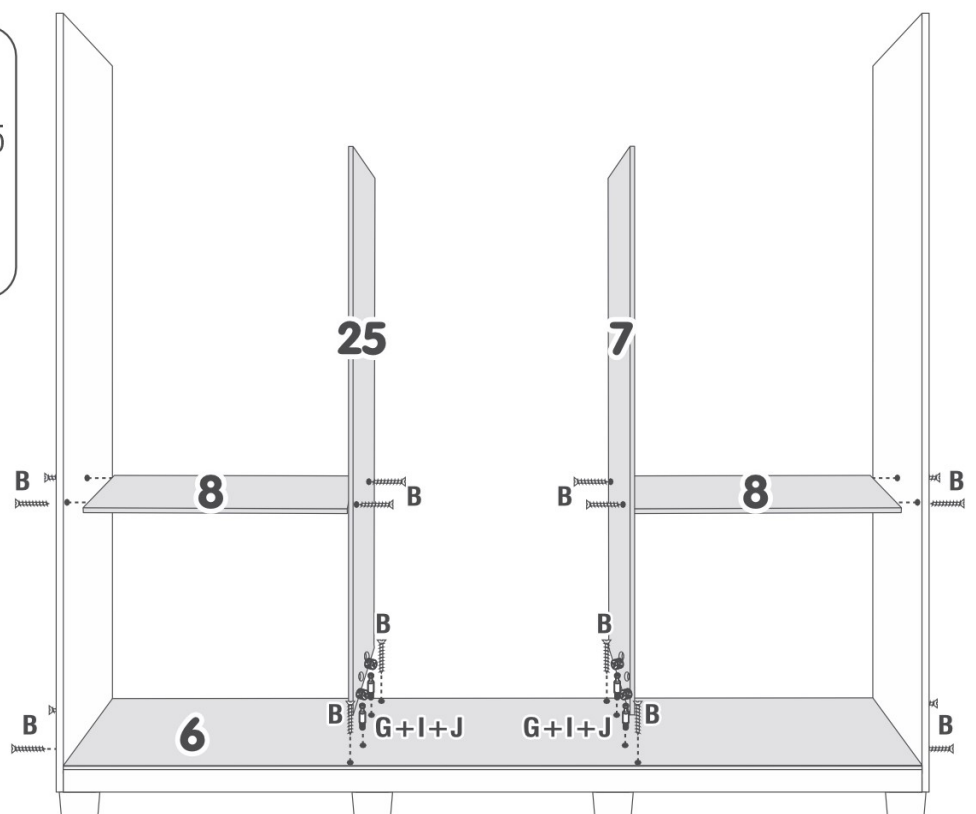
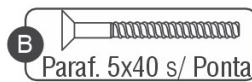

## Sequência de Montagem

- 08 - Encaixar e fixar peça 9 e 10 nas peças 7;
- 09 - Parafusar a peça 13 nas peças 1 e 4 em seguida parafusá-la nas peças 7;
- 10 - Parafusar peça 11 nas peças 10 e 13;
- 11 - Fixar as Peças 12 nas peças 7 e 11.

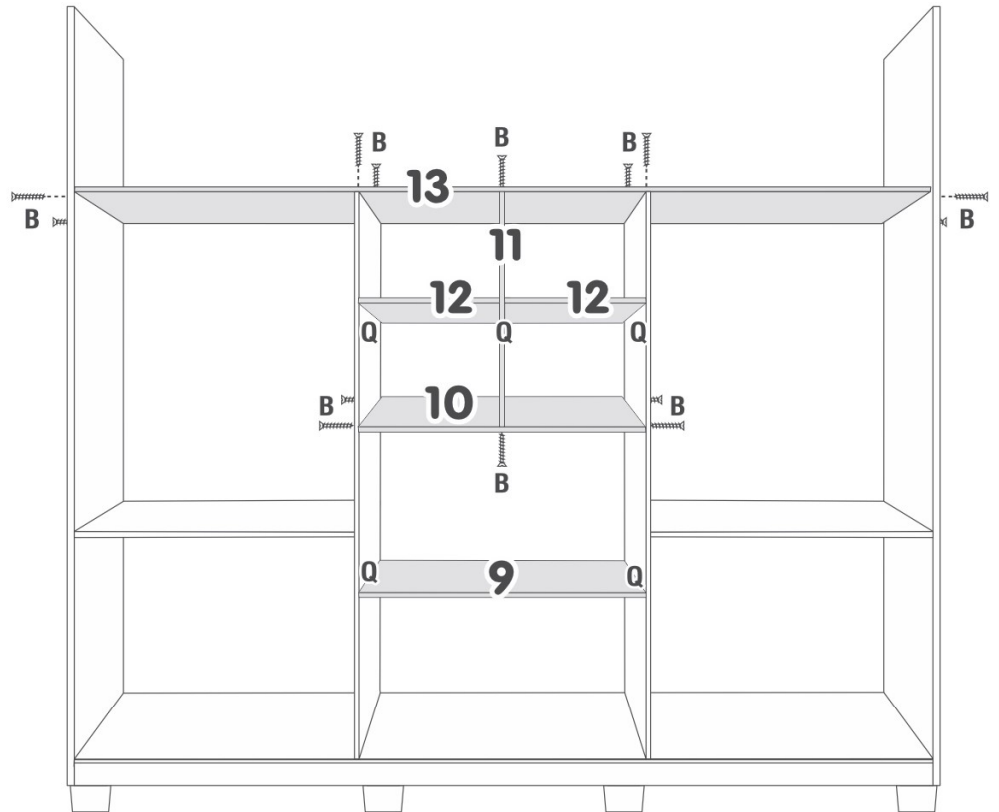
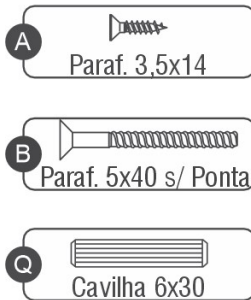

## Sequência de Montagem

- 12 - Fixar e parafusar peças 14 na peça 13.
- 13 - Encaixar e parafusar peça 15 na peças 01 e 04 e depois parafusá-la nas peças 14.

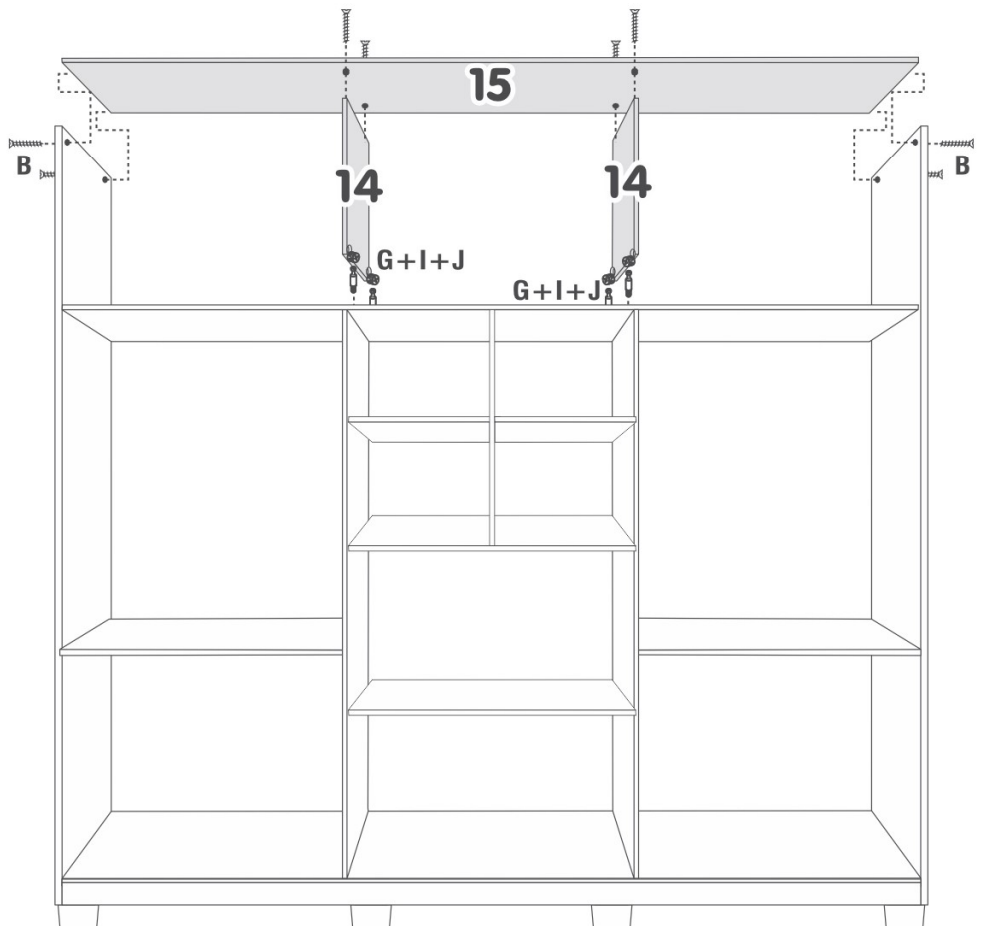

## Sequência de Montagem

- 14 - Fixar peças 16 nas peças 01, 04 e também na peça 15.  
 15 - Parafusar Alongador de corredeira conforme desenho.

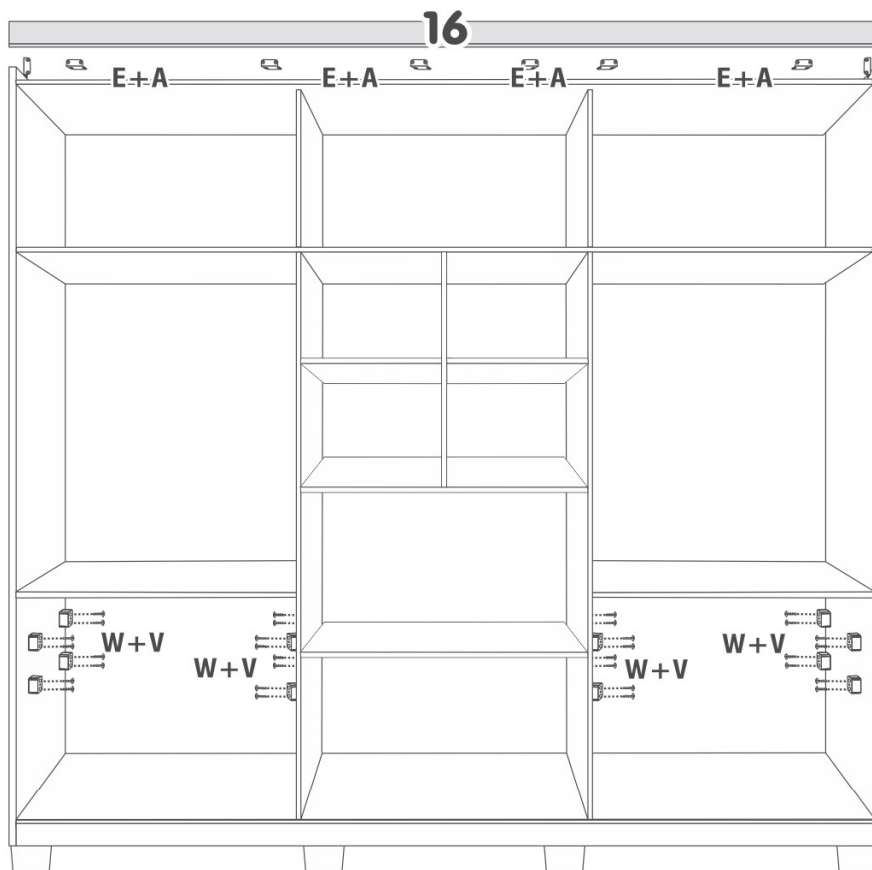

## Sequência de Montagem

- 16 - Montar os cabideiros com os suportes.  
 17 - Parafusar as corredeiras.

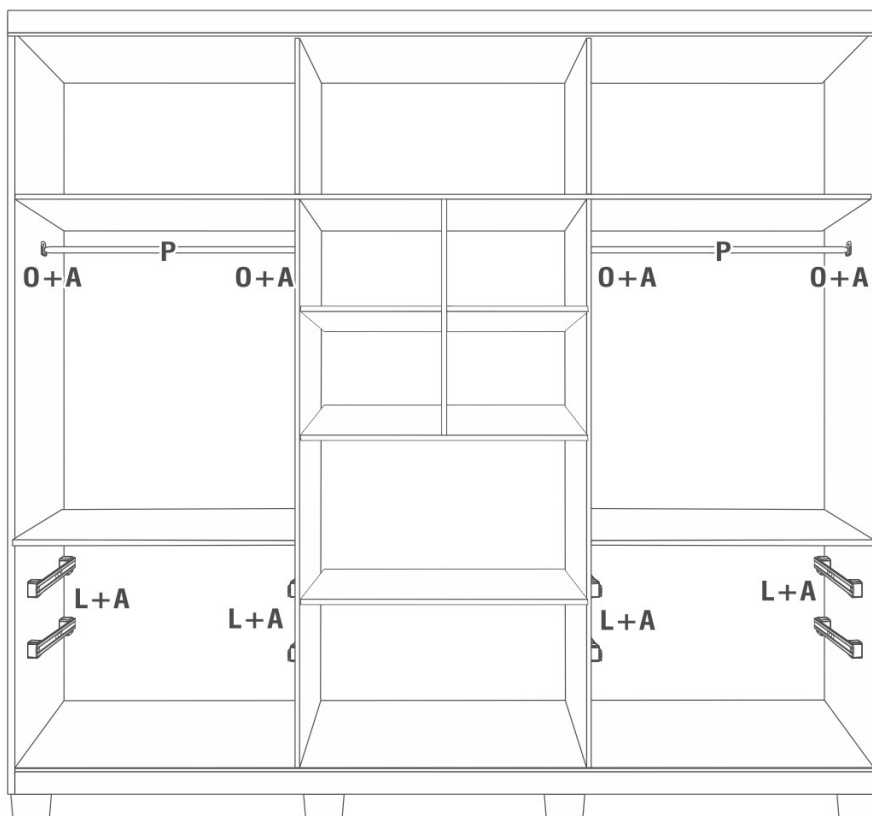

## Sequência de Montagem

18 - Preguar as Costas 22 conforme desenho ao lado.

OBS.: Acertar as costas para melhor esquadramento do móvel.

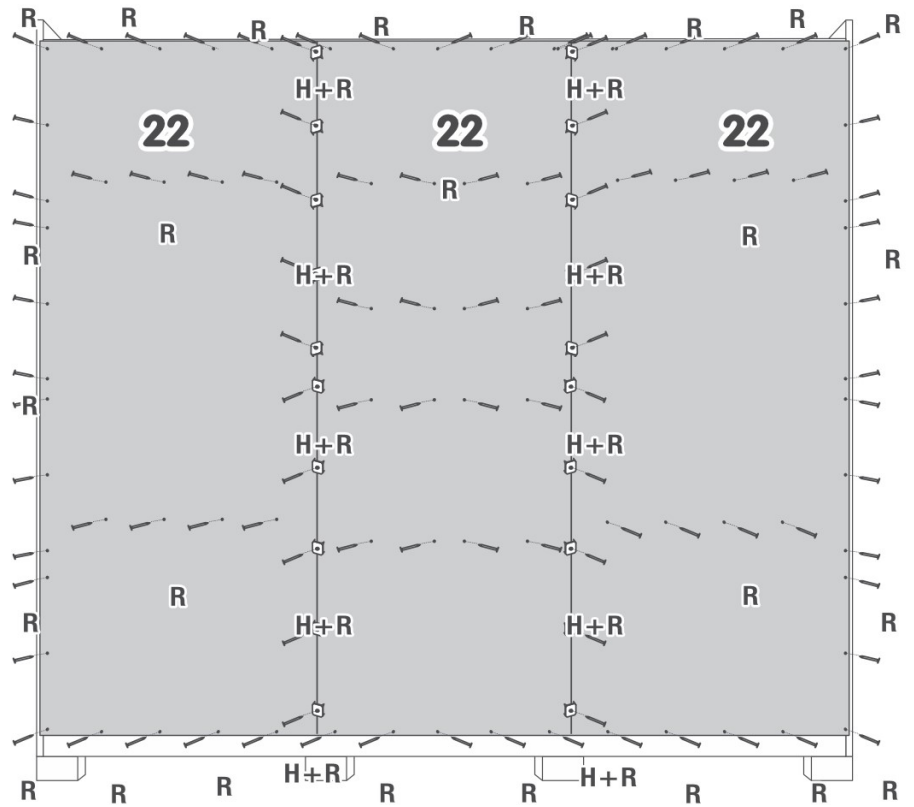
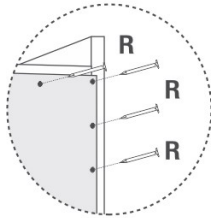

## Sequência de Montagem

19 - Montar e fixar as Portas 24.

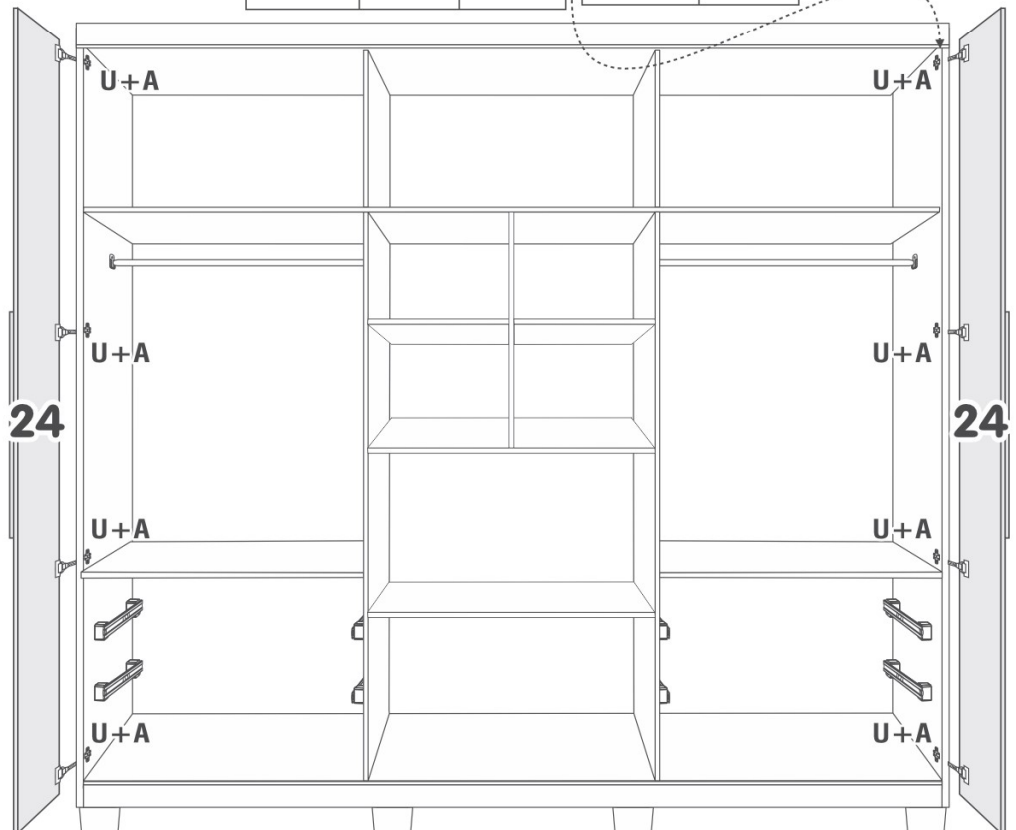
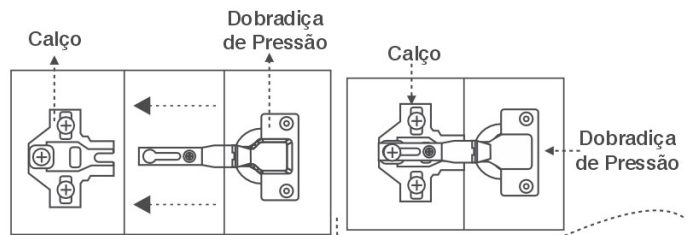
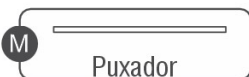
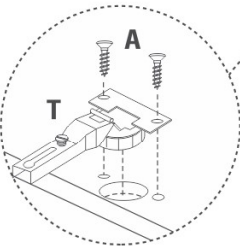

## Sequência de Montagem

- 20 - Parafusar as cantoneiras nas peças 19;
- 21 - Parafusar as peças 19 na peça 18 colocando cola nas cavilhas;
- 22 - Parafusar a peça 20 nas peças 19;
- 23 - Parafusar peça 21 nas peças 19 e 20 conforme desenho abaixo, ajustando para melhor esquadrejamento da gaveta;
- 24 - Parafusar as corrediças na lateral da peça 19;

