







ACESSÓRIOS

B4	BUCHA DE FIXAÇÃO NA PAREDE		4
G2	CHAPA CONEXÃO 60X40MM		2
G3	PASSA FIO		1
P1	PARAFUSO GERAL 3,5X14		8
P2	PARAFUSO 4,5X25		8
P6	PARAFUSO 4X50		22

VISTA EXPLODIDA

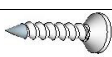

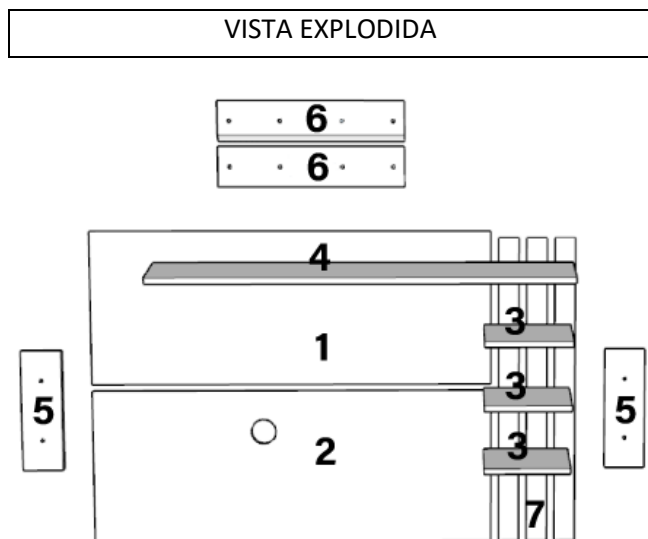
PEÇA	DESCRIÇÃO DA PEÇA	QUANTIDADE
1	PAINEL	1
2	PAINEL	1
3	PRATELEIRAS MENORES	3
4	PRATELEIRA MAIOR	1
5	APOIO DO PAINEL	2
6	TRAVESSA DE FIXAÇÃO	2
7	RIPADOS	3

PASSO 01

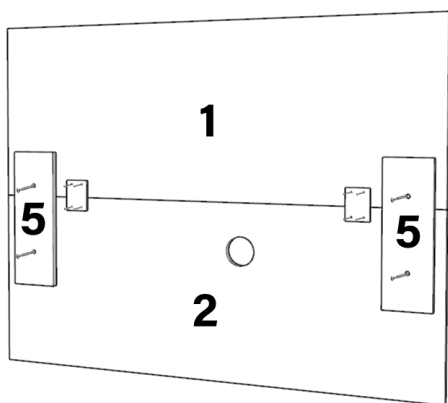

UNIR PAINÉIS "1, 2" USANDO CHAPA DE CONEXÃO "G2" E PARAFUSOS "P1".

APÓS, FIXE AS PEÇAS "5" USANDO PARAFUSO "P2".

PASSO 02

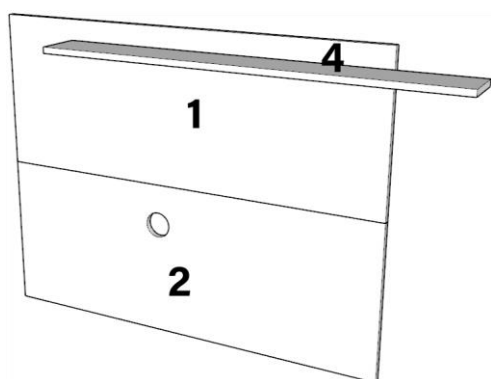

FIXAR PRATELEIRA MAIOR "4" USANDO PARAFUSO "P6".



PASSO 03

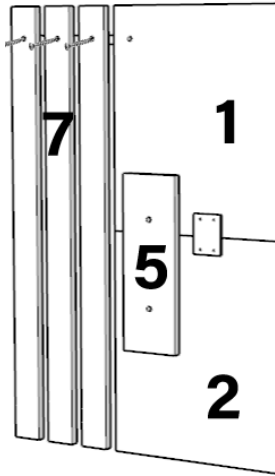

FIXAR RIPADOS "7" NA PRATELEIRA MAIOR "4" USANDO PARAFUSOS "P6".

OBS: DEIXE UM 1CM DE DISTÂNCIA ENTRE CADA RIPADO.

PASSO 04

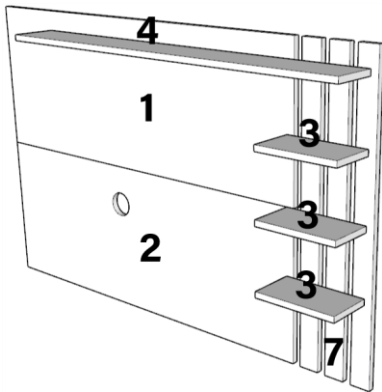

FIXAR PRATELEIRAS "3" NO RIPADO "7" USANDO PARAFUSOS "P6".

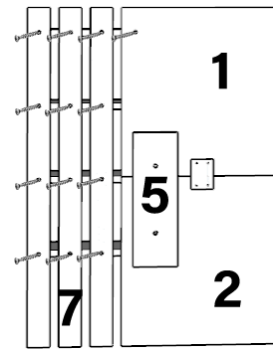

PASSO 05

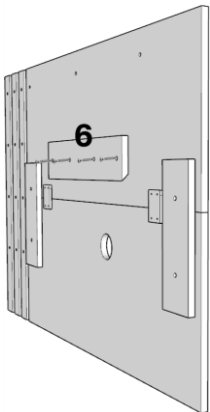

FIXAR TRAVESSA "6" NO PAINEL "1" UTILIZANDO PARAFUSOS "P2". ATENTE-SE QUE O CHANFRADO DEVE ESTAR PARA BAIXO. (CONFORME NA IMAGEM).

AGORA, FIXE NA PAREDE A PARTE 2 DA TRAVESSA "6" USANDO PARAFUSO "P6" + BUCHA "B4". ATENTE-SE QUE O CHANFRADO DEVE ESTAR PARA CIMA.











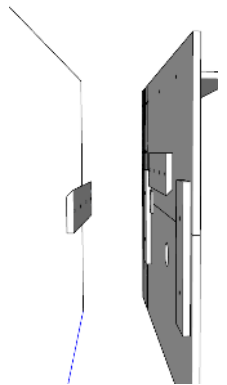
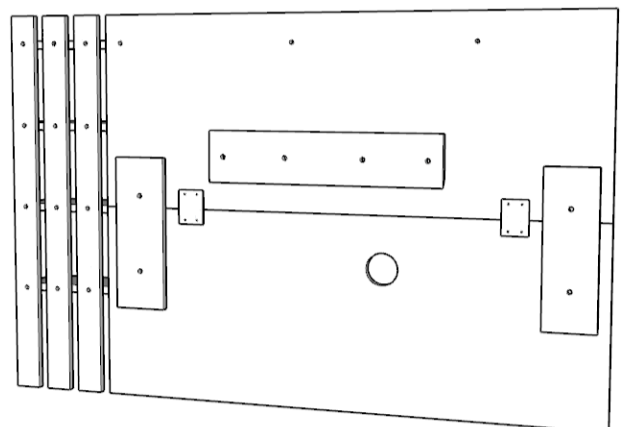
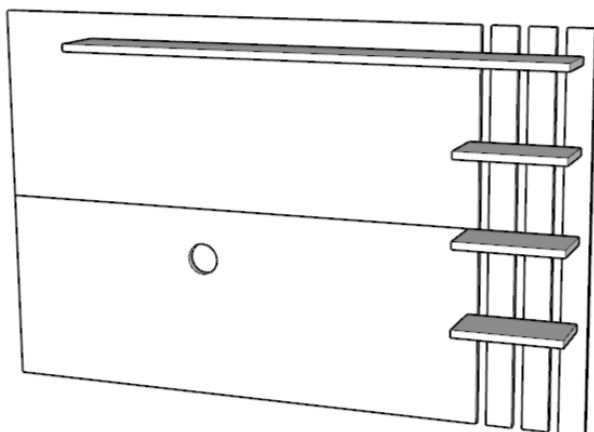



IMAGEM PRODUTO MONTADO



MANUAL DE MONTAGEM RACK TV 1200X600 15MM

ACESSÓRIOS

A1	ADESIVO TAPA FURO		16
C1	CAVILHA DE MADEIRA 6X30		24
D2	DOBRADIÇA BRAÇO CURVO		4
D3	DOBRADIÇA CALÇO		4
F3	PUXADOR		2
M1	TAMBOR MINIFIX		16
M2	HASTE MINIFIX ROSCA SOBERBA		16
P1	PARAFUSO GERAL 3,5X14		32
P2	PARAFUSO 4,5X25		2
P5	PREGOS 10X10		24
S2	PÉ TRIANGULAR		4

VISTA EXPLODIDA

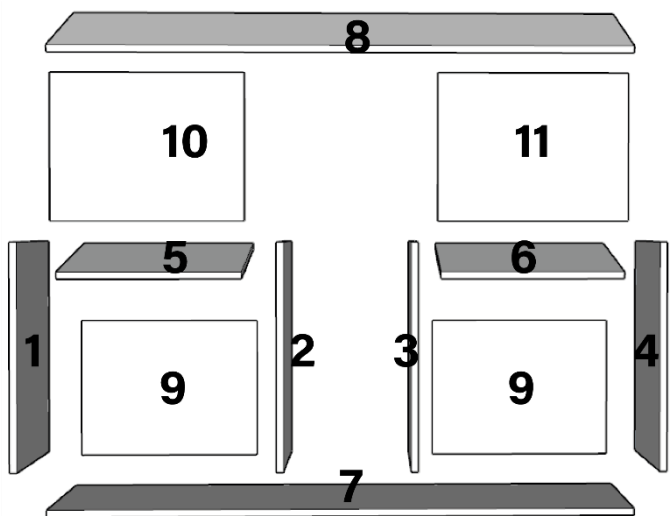

PEÇA	DESCRIÇÃO DA PEÇA	QUANTIDADE
1	LATERAL ESQUERDA	1
2	DIVISÓRIA ESQUERDA	1
3	DIVISÓRIA DIREITA	1
4	LATERAL DIREITA	1
5	PRATELEIRA ESQUERDA	1
6	PRATELEIRA DIREITA	1
7	BASE	1
8	TAMPO	1
9	EUCAPLAC	2
10	PORTA ESQUERDA	1
11	PORTA DIREITA	1

PASSO 01

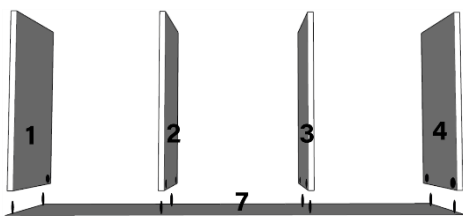

FIXE AS PEÇAS "1,2,3,4" NA BASE "7".

USE A HASTE "M2" NA BASE "7" E APÓS, USE TAMBOR "M1" NAS PEÇAS "1,2,3,4".

PASSO 02

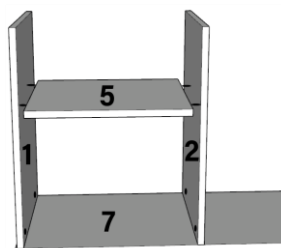

FIXAR DIVISÓRIA "5" NAS LATERAIS "1, 2".

USE CAVILHA "C1" NAS FURAÇÕES DA DIVISÓRIA "5".

REPITA O PROCESSO NO OUTRO LADO.

PASSO 03

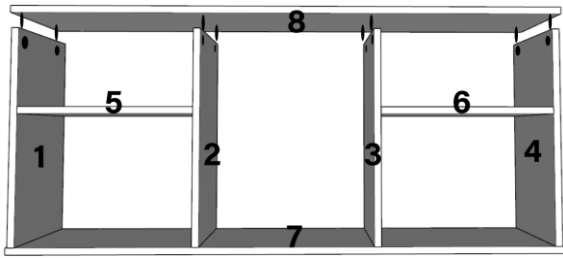

FIXE AS PEÇAS "1,2,3,4" NO TAMPO "8".

USE A HASTE "M2" NO TAMPO "8" E APÓS, USE TAMBOR "M1" NAS PEÇAS "1,2,3,4".

PASSO 04

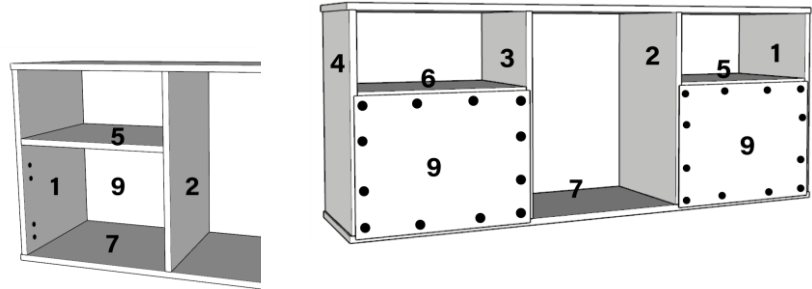

FIXAR EUCAPLAC "9" NA PARTE DE TRÁS.

(ATENTE-SE QUE HÁ PRÉ FURAÇÕES NAS LATERAIS PARA COLOCAR A DOBRADIÇAS "D3").

PASSO 05

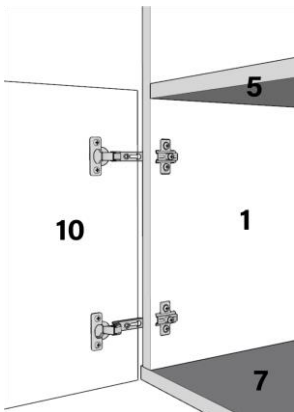

FIXAR PORTA "10".

USE DOBRADIÇA CALÇO "D3" + PARAFUSO 3,5X14 "P1" NA LATERAL "1" E DOBRADIÇA BRAÇO CURVO "D2" + PARAFUSO 3,5X14 "P1" NA PORTA "10".

REPITA O PROCESSO NO OUTRO LADO.

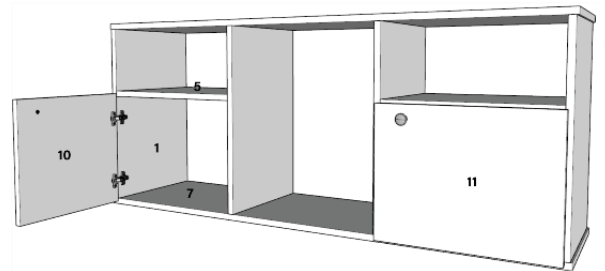

FIXAR PUXADOR "F3" NAS PORTAS "10" E "11" USANDO PARAFUSO 4,5X25 "P2".

PASSO 06

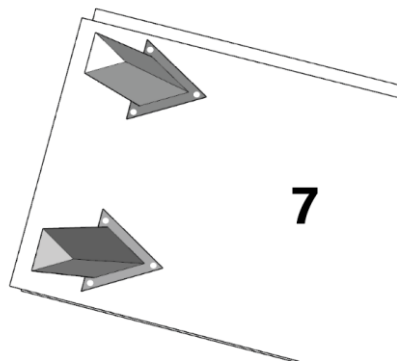

FIXAR PÉS "S2" NA BASE "7".

USE PARAFUSO 3,5X14 "P1" NAS FURAÇÕES DO PÉ.

FINALIZANDO O PROCESSO COLE OS ADESIVOS TAPA FURO "A1".

IMAGEM PRODUTO MONTADO

