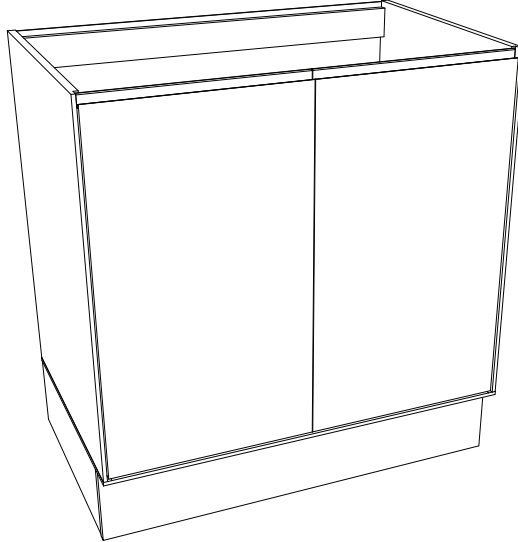

**HENN**Ind. e Com. de Móveis Henn  
Mondai - SC - Brasil

☎ +55 49 3674.3500

📷 📺 @moveishenn  
www.henn.com.br**INSTRUÇÕES DE  
MONTAGEM****INSTRUCCIONES DE MONTAJE  
ASSEMBLY INSTRUCTIONS****BALCÃO 2 PORTAS 800MM FINEZE | MOSTRADOR FINEZE DE 2 PUERTAS DE 800MM |  
FINEZE 800MM 2-DOOR COUNTER****C661-133 Areia HP****AVISO**

Para limpeza de seu móvel, use uma flanela seca ou umedecida, e não utilize produtos químicos que possam danificar seu produto.

**SISTEMA DE MONTAGEM**

O sistema de montagem dos produtos, funciona de acordo com a ordem crescente dos números indicados no desenho. Ex: 01, 02, 03, 04... até a conclusão da montagem.

**ASSISTÊNCIA TÉCNICA**

Para solicitação de Assistência Técnica você consumidor deverá entrar em contato com o Lojista o qual você realizou a compra deste produto e solicitar a assistência técnica das peças avariadas. A garantia abrange todas as peças, partes e componentes que eventualmente venham apresentar defeito de fabricação no prazo de 03 (três) meses, contando a partir da entrega do produto ao consumidor, mediante nota fiscal de compra. Se houver qualquer alteração na estrutura do produto ou ocorrer defeito por negligência do montador/consumidor em relação a instrução de montagem e manuseio, não será fornecido assistência técnica gratuita.

**ADVERTENCIA**

Para limpieza de su móvil, use una flanela seca o húmeda, y no utilice productos químicos que puedan dañar su producto.

**SISTEMA DE MONTAJE**

El sistema de montaje de los productos funciona de acuerdo con el orden creciente de los números indicados en el dibujo. Ej.: 01, 02, 03, 04... hasta la conclusión del montaje.

**ASISTENCIA TÉCNICA**

Para solicitar Asistencia Técnica, el consumidor debe comunicarse con el Comercio que usted realizó la compra de este producto y solicita asistencia técnica para las partes dañadas. La garantía cubre todas las partes, piezas y componentes que eventualmente puedan presentar defecto de fabricación en el plazo de 03 (tres) meses, contados a partir de la entrega del producto al consumidor, mediante factura de compra. Si se produce algún cambio en la estructura del producto o se produce un defecto por negligencia del montador/consumidor en relación con las instrucciones de montaje y manipulación, no se prestará asistencia técnica gratuita.

**NOTICE**

To clean your furniture, use a dry or wet cloth, and do not use chemicals that may damage your product.











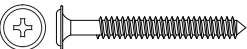

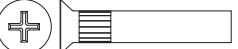

**ASSEMBLY SYSTEM**

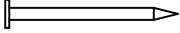
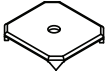
The products' assembly system works according to the increasing order of the indicated numbers. For example: 01, 02, 03, 04 ... to the end of the assembly.

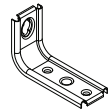
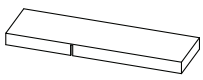
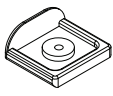
**TECHNICAL ASSISTANCE**

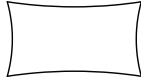
To request Technical Assistance, the consumer must contact the retailer from whom you purchased this product and request technical assistance for the damaged parts. The warranty covers all parts, parts and components that may eventually present a manufacturing defect within a period of 03 (three) months, counting from the delivery of the product to the consumer, by means of a purchase invoice. If there is any change in the structure of the product or defect occurs due to negligence of the assembler/consumer in relation to the assembly and handling instruction, free technical assistance will not be provided.

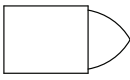
# ACESSÓRIOS | ACCESORIOS | ACCESSORIES

<p><b>A</b> x4</p>  <p>Parafuso 5,0x50mm FLA.</p>	<p><b>B</b> x19</p>  <p>Parafuso 3,5x40mm CHT.</p>	<p><b>C</b> x52</p>  <p>Parafuso 4,0x14mm CHT.</p>	<p><b>D</b> x4</p>  <p>Parafuso União Fêmea 27mm CHT</p>
<p><b>E</b> x4</p>  <p>Parafuso União Macho 12mm CHT</p>	<p><b>F</b> x20</p>  <p>Cavilha Plástica 8x25mm</p>	<p><b>G</b> x4</p>  <p>Prego 12x12mm Anelado</p>	<p><b>H</b> x28</p>  <p>Prego 10x10mm</p>
<p><b>I</b> x8</p>  <p>Fixador de Fundo</p>	<p><b>J</b> x8</p>  <p>Cantoneira de Fixação Metal</p>	<p><b>K</b> x4</p>  <p>Bucha Plástica 8mm</p>	<p><b>L</b> x2</p>  <p>Suporte de Fixação</p>
<p><b>M</b> x2</p>  <p>Proteção Cantoneira</p>	<p><b>N</b> x4</p>  <p>Sapata "L" 16x20mm</p>	<p><b>O</b> x4</p>  <p>Dob 35mm POP Alta C/Amortecedor + Calço Fixo</p>	<p><b>P</b> x1</p>  <p>Sachê de Cola</p>
<p><b>Q</b> x16</p>  <p>Adesivo Tapa Parafuso 10mm</p>	<p><b>R</b> x2</p>  <p>Giz de Correção</p>	<p><b>S</b> x1</p>  <p>Etiqueta Resinada Henn</p>	

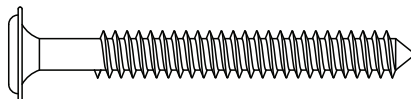
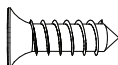
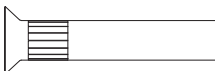
**PARAFUSOS EM ESCALA 1:1 | TORNILLOS A ESCALA 1:1 | 1:1 SCALE SCREWS****A****B****C****D****E**

## LISTA DE PEÇAS | LISTA DE PIEZAS | LIST OF PIECES

Item	Caixa Caja Box	Qty Ctd Qty	Descrição Descripción Description	Dimensões (mm)   Dimensiones (mm)   Dimensions (mm)		
				Comprimento Largo Length	Largura Ancho Width	Espessura Grosor Thickness
1	1/1	1	RODAPÉ FRONTAL   ZÓCALO DELANTERO   FRONT BASEBOARD	800	145	15
2	1/1	2	RODAPÉ LATERAL   ZÓCALO LATERAL   SIDE BASEBOARD	450	145	15
3	1/1	1	RODAPÉ TRASEIRO   ZÓCALO TRASERO   REAR BASEBOARD	768	145	15
4	1/1	1	BASE   BASE   BASE	800	507	15
5	1/1	1	LATERAL ESQUERDA   LATERAL IZQUIERDO   LEFT BACK	686	507	15
6	1/1	1	PRATELEIRA   ESTANTE   SHELF	769	400	15
7	1/1	1	TRAVESSA TRASEIRA   TRAVESAÑO TRASERO   REAR CROSSMEMBER	769	60	15
8	1/1	1	TRAVESSA FRONTAL   BARRA TRANSVERSAL DELANTERA   FRONT CROSSBAR	769	60	15
9	1/1	1	LATERAL DIREITA   DE VUELTA A LA DERECHA   RIGHT BACK	686	507	15
10	1/1	2	FUNDO   FONDO   BOTTOM	791	343	3
11	1/1	1	PORTA ESQUERDA   PUERTA IZQUIERDA   LEFT DOOR	680	390	15
12	1/1	1	PORTA DIREITA   PUERTA DERECHA   RIGHT DOOR	680	390	15

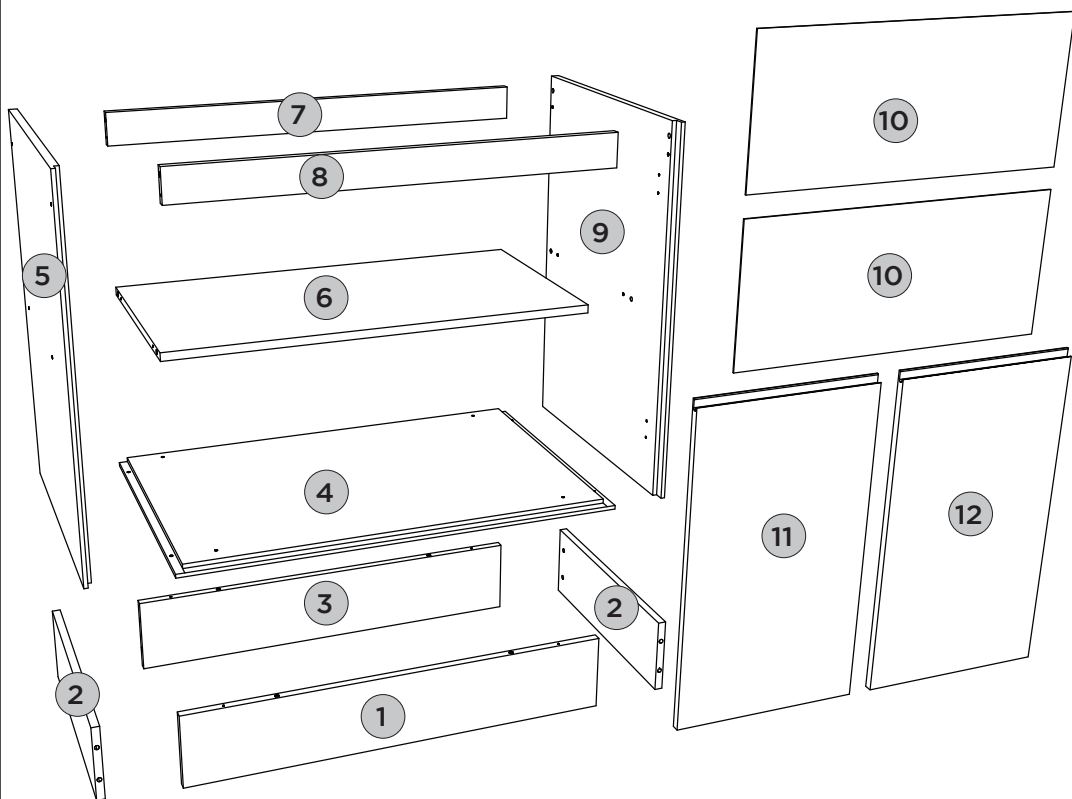

### REQUISITOS PARA MONTAGEM

### REQUISITOS PARA LA MONTAJE | ASSEMBLY REQUIREMENTS.

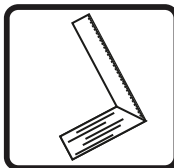
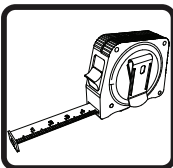
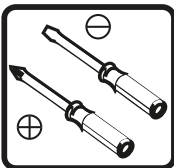
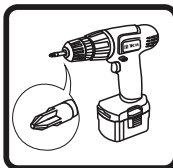

Imagens meramente ilustrativas, não acompanha o produto.





Imágenes ilustrativas, no incluidas con el producto.

Illustrative images, not included with the product.

**PEÇAS REQUERIDAS**

1	RODAPÉ FRONTAL	x1
2	RODAPÉ LATERAL	x2
3	RODAPÉ TRASEIRO	x1
6	PRATELEIRA	x1
7	TRAVESSA TRASEIRA	x1
8	TRAVESSA FRONTAL	x1

**ACESSÓRIOS REQUERIDOS**

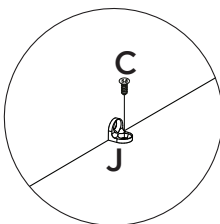
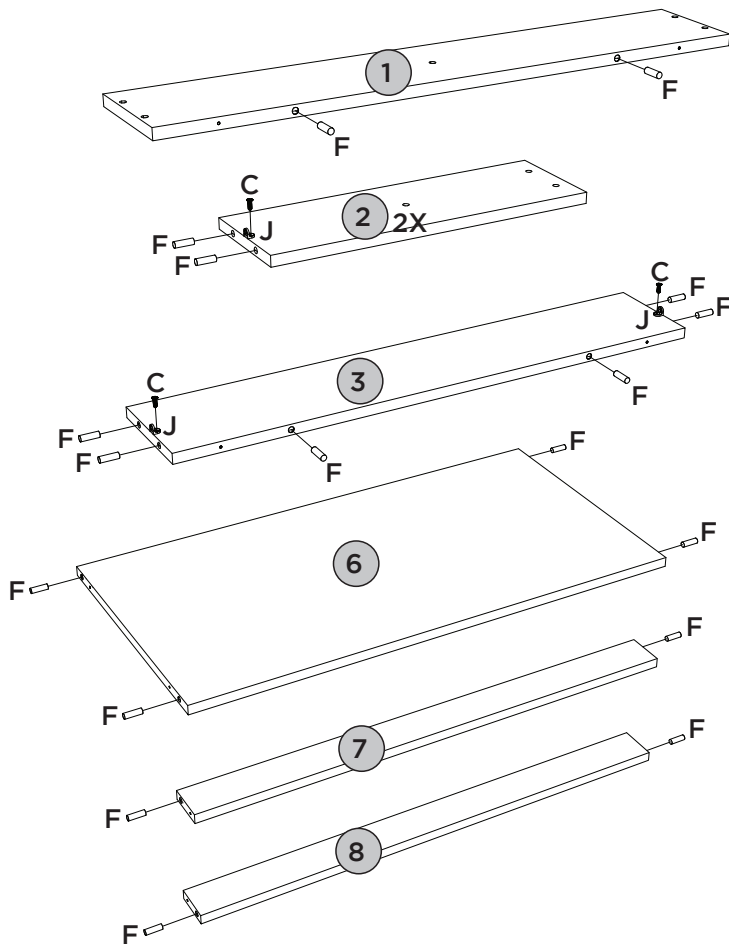
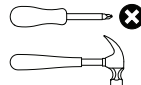

C		04
F		20
J		04
P		

**FERRAMENTAS NECESSÁRIAS**

**PEÇAS REQUERIDAS**

11	PORTA ESQUERDA	x1
12	PORTA DIREITA	x1

**ACESSÓRIOS REQUERIDOS**

C		08
O		04

**FERRAMENTAS NECESSÁRIAS**

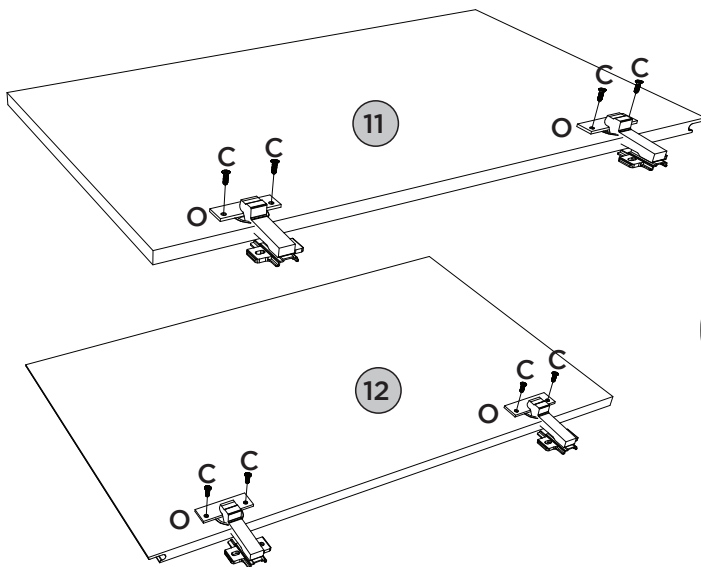
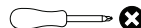



**MONTAGEM 1** | MONTAJE 1 | ASSEMBLY 1

**PEÇAS REQUERIDAS**

1	RODAPÉ FRONTAL	x1
2	RODAPÉ LATERAL	x2
3	RODAPÉ TRASEIRO	x1

**ACESSÓRIOS REQUERIDOS**

C		04
G		04
N		04

**FERRAMENTAS NECESSÁRIAS**

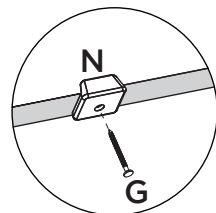
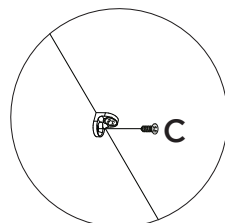
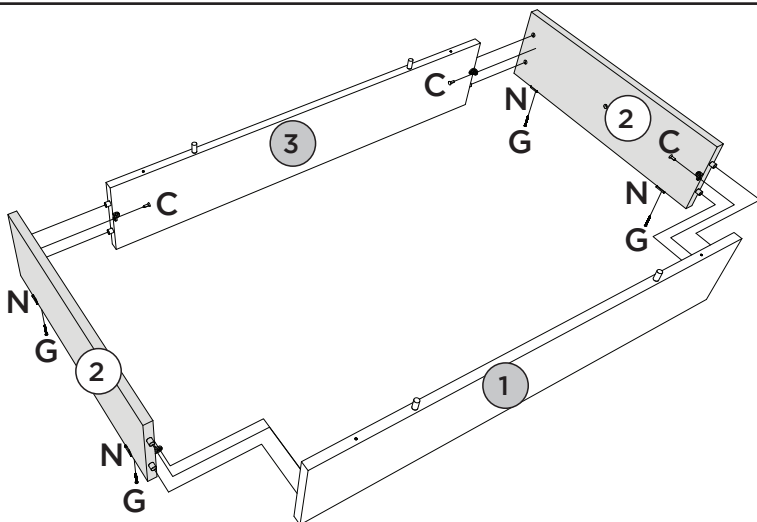
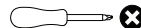

# MONTAGEM 2 | MONTAJE 2 | ASSEMBLY 2

## PEÇAS REQUERIDAS

4	BASE	x1
5	LATERAL ESQUERDA	x1
6	PRATELEIRA	x1
7	TRAVESSA TRASEIRA	x1
8	TRAVESSA FRONTAL	x1
9	LATERAL DIREITA	x1

## ACESSÓRIOS REQUERIDOS



## FERRAMENTAS NECESSÁRIAS

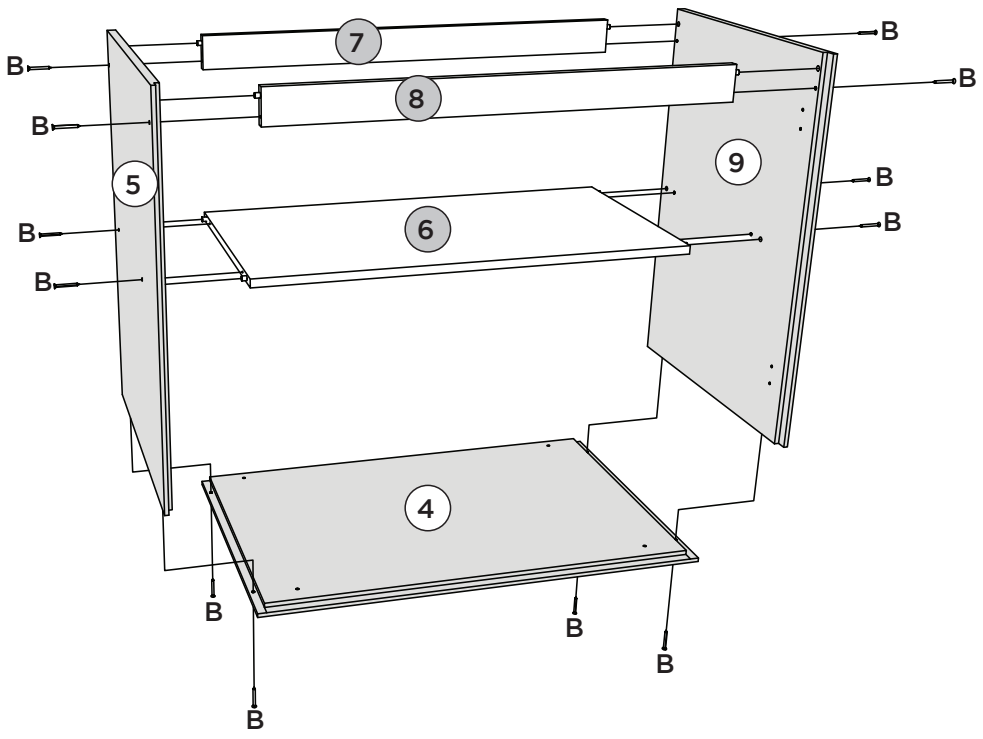
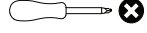

**ACESSÓRIOS REQUERIDOS**

**FERRAMENTAS NECESSÁRIAS**

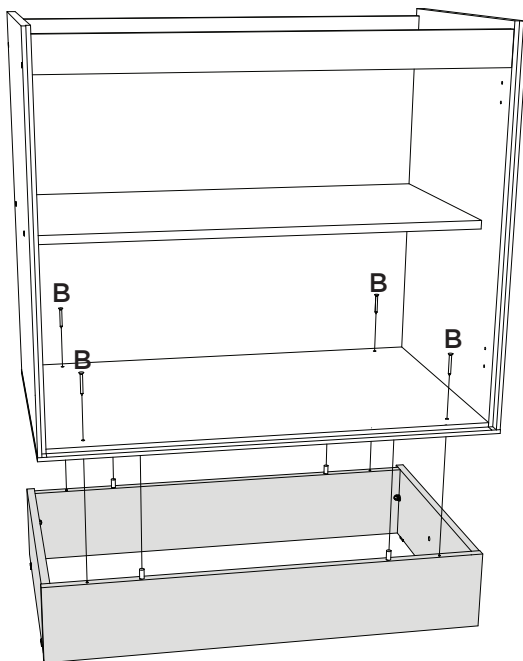
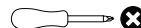
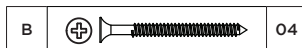

**MONTAGEM 4** | MONTAJE 4 | ASSEMBLY 4

**ACESSÓRIOS REQUERIDOS**

**FERRAMENTAS NECESSÁRIAS**

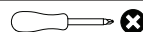
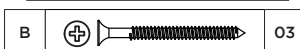

**Opção com Tampo**

O Tampo é vendido separadamente (C921-133/214).  
As ferragens para fixação do Tampo constam no produto.

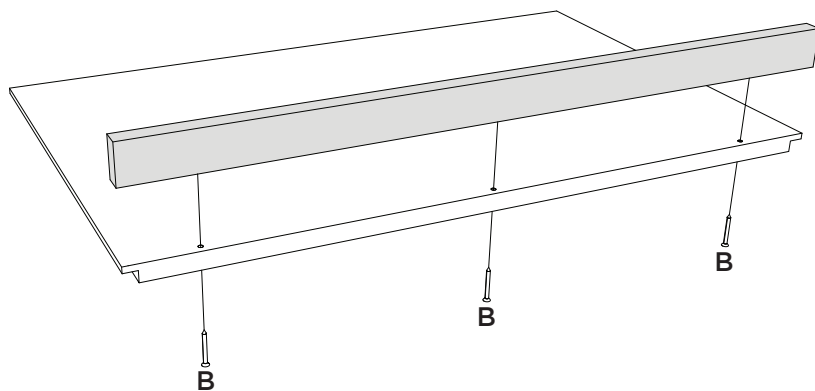

# MONTAGEM 5 | MONTAJE 5 | ASSEMBLY 5

ITM/C661-

## ACESSÓRIOS REQUERIDOS

C		08
J		04

## FERRAMENTAS NECESSÁRIAS

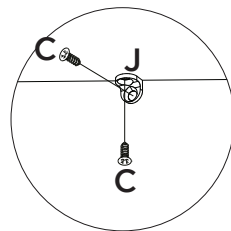
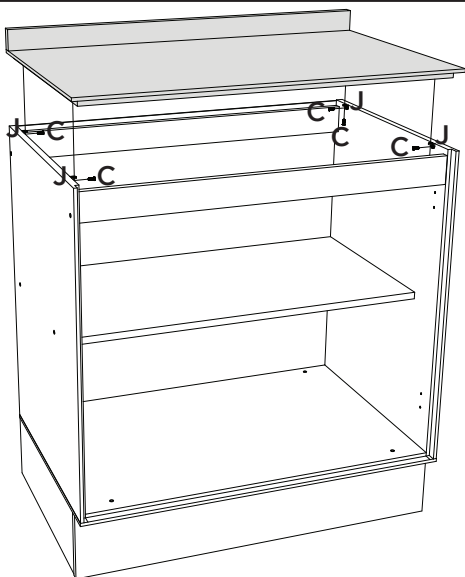



# MONTAGEM 6 | MONTAJE 6 | ASSEMBLY 6

## PEÇAS REQUERIDAS

10	FUNDO	x2
----	-------	----

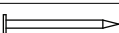
## ACESSÓRIOS REQUERIDOS

C		08
H		28
I		08

## FERRAMENTAS NECESSÁRIAS

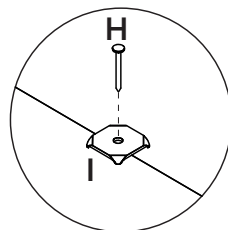
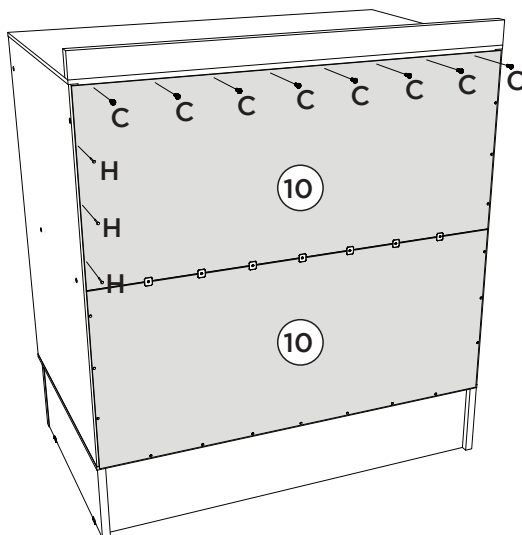
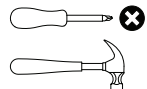

## PEÇAS REQUERIDAS

11	PORTA ESQUERDA	x1
12	PORTA DIREITA	x1





## ACESSÓRIOS REQUERIDOS

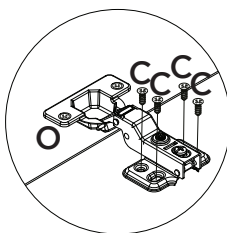
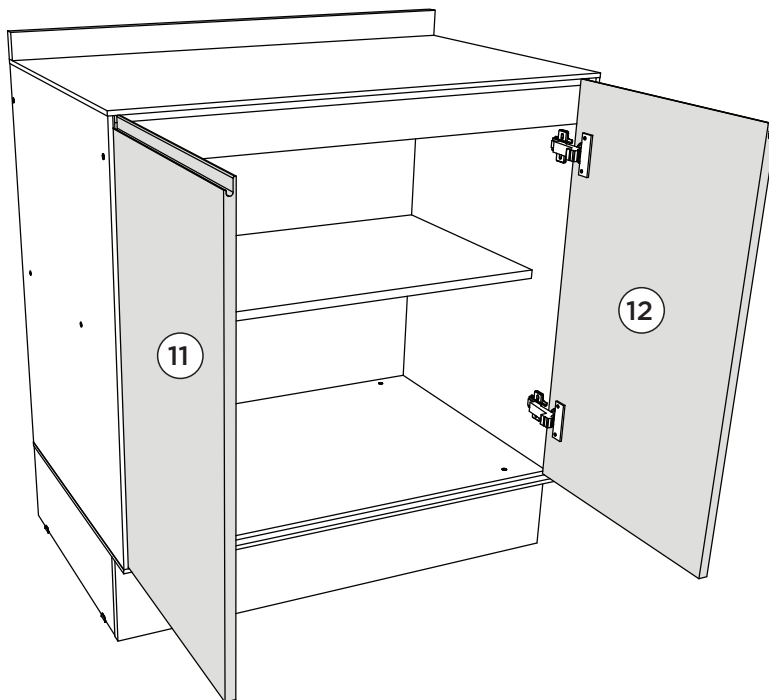
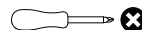

## FERRAMENTAS NECESSÁRIAS

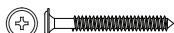

## ACESSÓRIOS REQUERIDOS

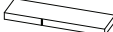
A		02	K		02
C		04	L		02
			M		02

## FERRAMENTAS NECESSÁRIAS

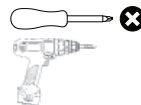

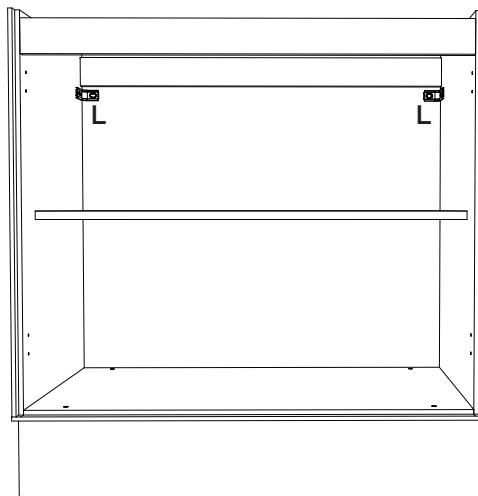
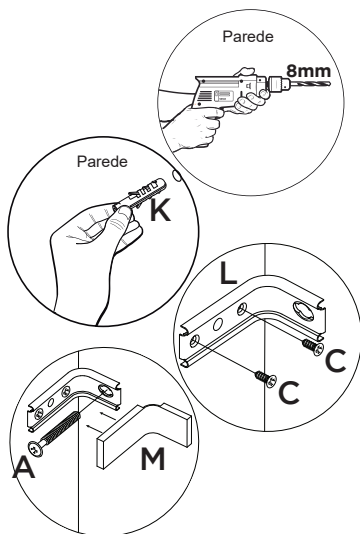

### Fixar móvel na Parede



# MONTAGEM 9 | MONTAJE 9 | ASSEMBLY 9

## ACESSÓRIOS REQUERIDOS

A		02
K		02



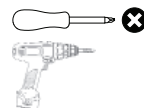

## FERRAMENTAS NECESSÁRIAS

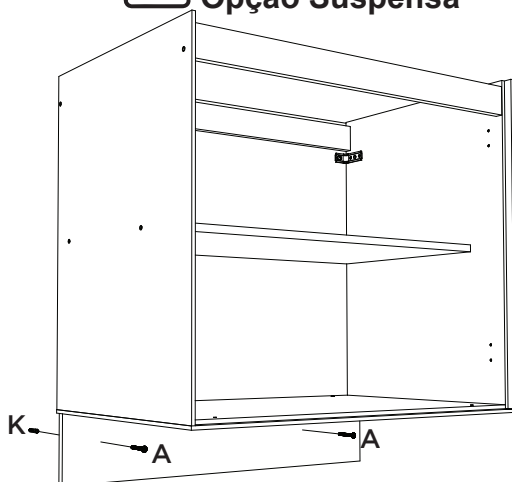
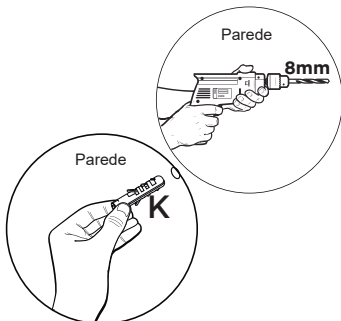

### Opção Suspensa



## ACESSÓRIOS REQUERIDOS

D			04
E			04

## FERRAMENTAS NECESSÁRIAS

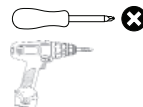
**OBSERVAÇÃO:**

Os parafusos (D e E) devem ser usados somente quando esse módulo for acoplado em outro módulo componível.

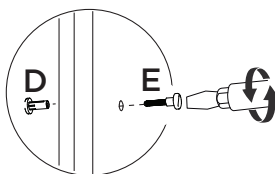

Fazer furação passante assim que os módulos estiverem alinhados.

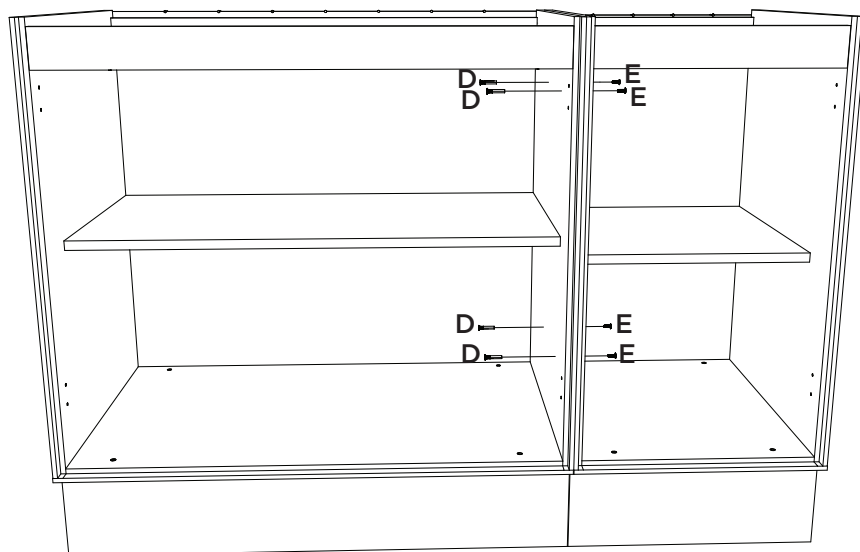

Balcão 2 Portas 800mm

Módulo Componível

## FERRAMENTAS NECESSÁRIAS

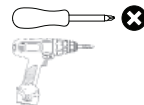

 **Opção com Pés**

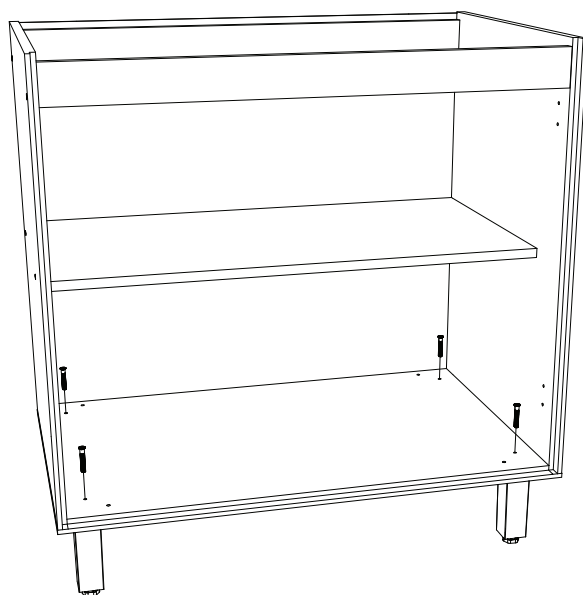
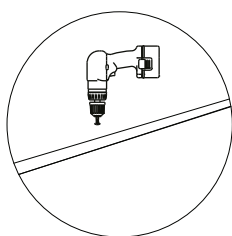
O Kit Pés é vendido separadamente (O898-121).  
As ferragens para fixação do Pés constam no Kit.



Para fixar os pés,  
é necessário  
fazer a furação  
passante da  
Base.

**ACESSÓRIOS REQUERIDOS**

Q		16
R		02
S	<b>HENN</b>	01

**Pesos máximos recomendados com carga distribuída.**  
**Peso máximo recomendado con la carga distribuída.**  
**Recommended maximum weight with distributed load.**

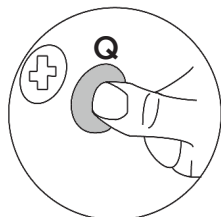
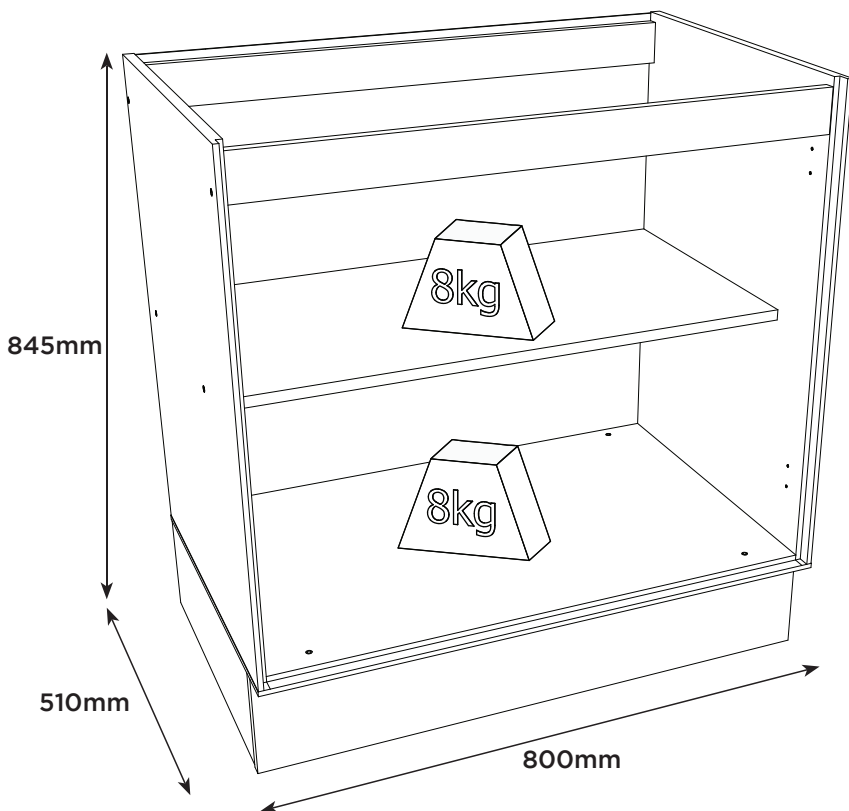

**PERFECT CORRECTION**  
**CORRECCIÓN PERFECTA**

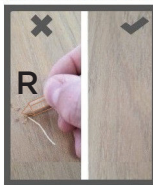



**PRODUTO CONCLUÍDO**  
**PRODUCTO TERMINADO**  
**FINISHED PRODUCT**

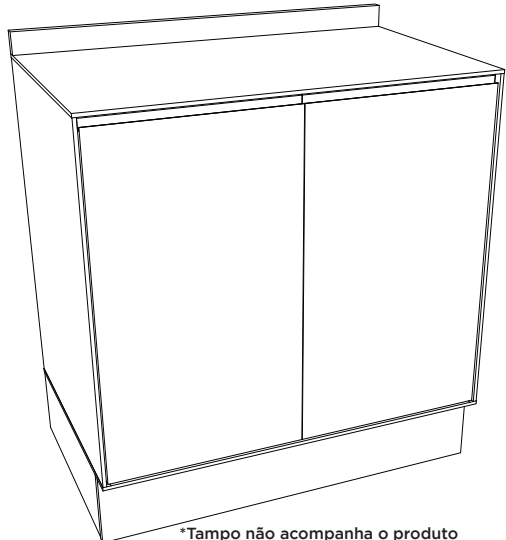
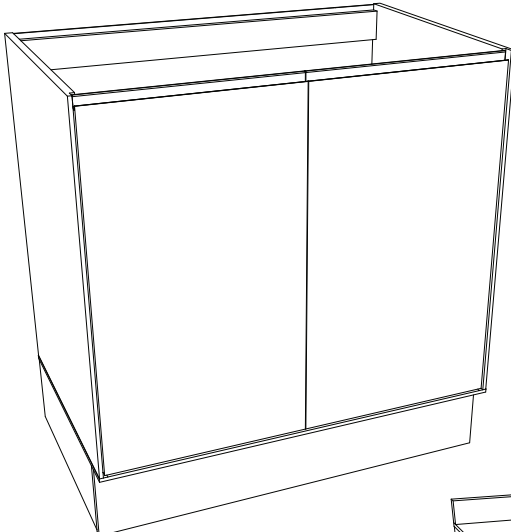

\*Tampo não acompanha o produto

