











MANUAL DE MONTAGEM APARADOR PÉ TRIANGULAR 2P 15MM 800x660

ACESSÓRIOS

A1	ADESIVO TAPA FURO		8
C1	CAVILHA DE MADEIRA 6X30		16
D1	DOBRADIÇA BRAÇO CURVO		4
D3	DOBRADIÇA CALÇO		4
F3	PUXADOR		2
G1	GARRA COSTA ARMÁRIO		4
M1	TAMBOR MINIFIX		8
M2	HASTE MINIFIX ROSCA SOBERBA		8
P1	PARAFUSO GERAL 3,5X14		28
P2	PARAFUSO 4,5X25		2
P5	PREGOS 10X10		24
S2	PÉ TRIANGULAR		4

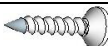
VISTA EXPLODIDA

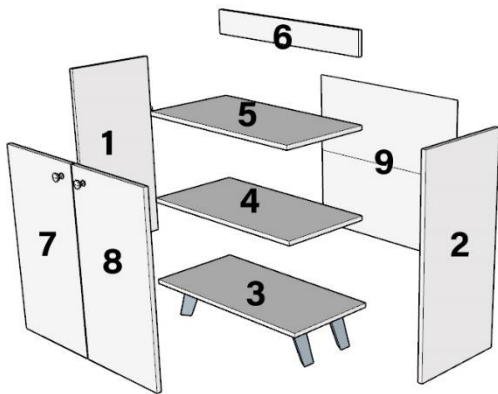

PEÇA	DESCRIÇÃO DA PEÇA	QUANTIDADE
1	LATERAL ESQ.	1
2	LATERAL DIR.	1
3	BASE	1
4	PRATELEIRA	1
5	TAMPO	1
6	TRAVESSA	1
7	PORTA ESQ.	1
8	PORTA DIR.	1
9	EUCAPLAC (A,B)	1

PASSO 01

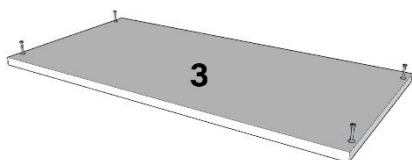

NA BASE "3"  
ENCAIXE AS  
HASTES MINIFIX  
"M2".

PASSO 02

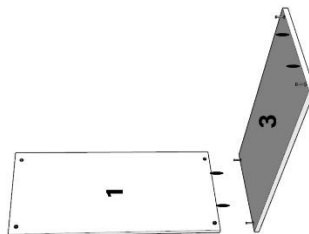

NA LATERAL ESQ. "1" FIXE CAVILHA  
DE MADEIRA "C1" NA PARTE  
INFERIOR.

FIXE A LATERAL ESQ "1" NA BASE "3"  
SOBRE A HASTE "M2".

PASSO 03

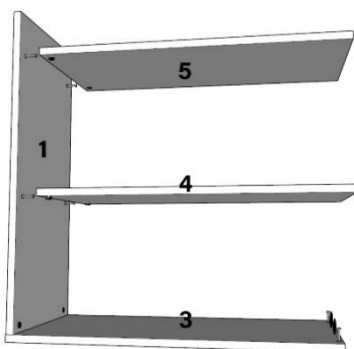

NAS FURAÇÕES DA LATERAL "1" FIXE  
HASTE MINIFIX "M2".

APÓS, ENCAIXE CAVILHAS "C1" NA  
PRATELEIRA "4" E NO TAMPO "5",  
ASSIM FIXE-AS NA LATERAL "1".

NA SEQUÊNCIA, FIXE O TAMBOR  
"M1" NAS FURAÇÕES DA PRATELEIRA  
"4" E TAMPO "5" E APORTE-OS.

PASSO 04

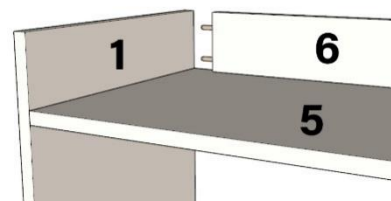

NA TRAVESSA "6"  
ENCAIXE CAVILHA  
DE MADEIRA "C1"  
E APÓS FIXE NA  
LATERAL "1".

PASSO 05

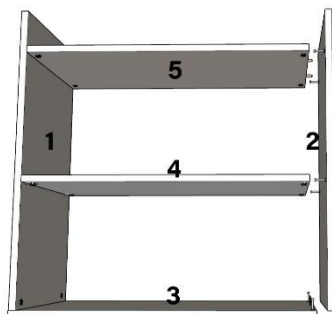

REPITA OS PASSOS (2, 3 E 4) PARA FIXAR A LATERAL "2".

PASSO 06

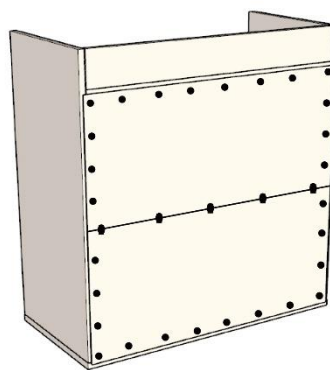

FIXAR EUCAPLAC "9" USANDO PREGOS "P5" EM TODA A SUA VOLTA. ENTRE OS EUCAPLAC'S "9 (A, B)" USE GARRA "G1" + PREGO "P5" PARA FIXA-

PASSO 07

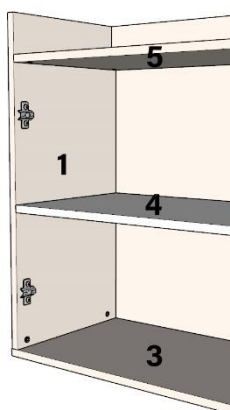

NA LATERAL "1" FIXE A DOBRADIÇA CALÇO "D3" USANDO PARAFUSO 3,5X14 "P1".

APÓS, REPITA O PROCESSO NO OUTRO LADO.

PASSO 08

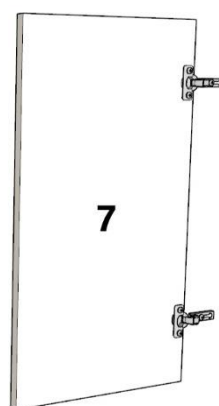

NA PORTA ESQ "7" FIXE A DOBRADIÇA BRAÇO CURVO "D1" USANDO PARAFUSO 3,5X14.

APÓS, REPITA O PROCESSO NO OUTRO LADO.

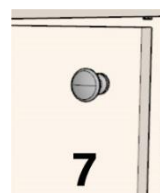

FIXAR PUXADOR "F3" NA PORTA "7" USANDO PARAFUSO 4,5X25.

REPITA O PROCESSO NO OUTRO LADO.

PASSO 09

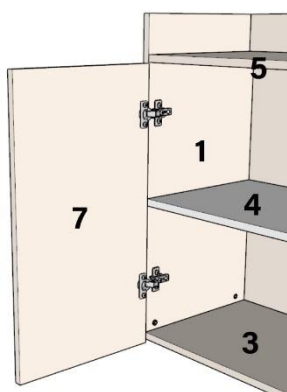

UNA AS DOBRADIÇAS "D1 E D3" PARA FIXAR A PORTA "7" NA LATERAL "1".

USE PARAFUSO 3,5X14 PARA REALIZAR A TAREFA.

APÓS, REPITA O PROCESSO NO OUTRO LADO.

PASSO 10

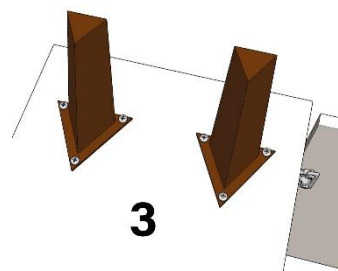

FIXAR PÉ TRIANGULAR "S2" NA BASE "3" USANDO PARAFUSO 3,5X14.

PARA FINALIZAR A MONTAGEM, COLE OS ADESIVOS TAPA FUROS "A1".

IMAGEM PRODUTO MONTADO

