

MANUAL DE MONTAGEM

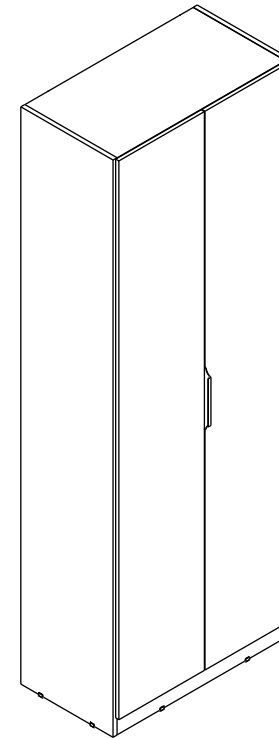

Sapateira Sublime c/ espelho



Abaixo sinalizadas, as ferramentas não fornecidas, mas necessárias para a montagem do produto.

MAMBEL MÓVEIS LTDA
Av. Valmor Bernardo Bonotto , 5050 - Bairro:Distrito Industrial III, - Cep. 95300-000
Lagoa Vermelha - Rio Grande do Sul - Brasil
Fone/fax: 55 (54) 3358 1060
E-mail: sac@mambel.com.br
Site: www.mambel.com.br



Partes do Produto

- ❶ Lateral Esquerda (1x) 1870 x 345 x 15mm
- ❷ Lateral Direita (1x) 1870 x 345 x 15mm
- ❸ Tampo Inferior (1x) 630 x 345 x 15mm
- ❹ Tampo Superior (1x) 630 x 345 x 15mm
- ❺ Prateleira Móvel (3x) 630 x 335 x 15mm
- ❻ Prateleira Fixa (2x) 630 x 335 x 15mm
- ❼ Rodapé Frontal (1x) 630 x 60 x 15mm
- ❽ Rodapé Traseiro (1x) 630 x 60 x 15mm
- ❾ Porta com espelho (2x) 1810 x 320 x 15mm
- ❿ Fundo (1x) 1806 x 656 x 3mm

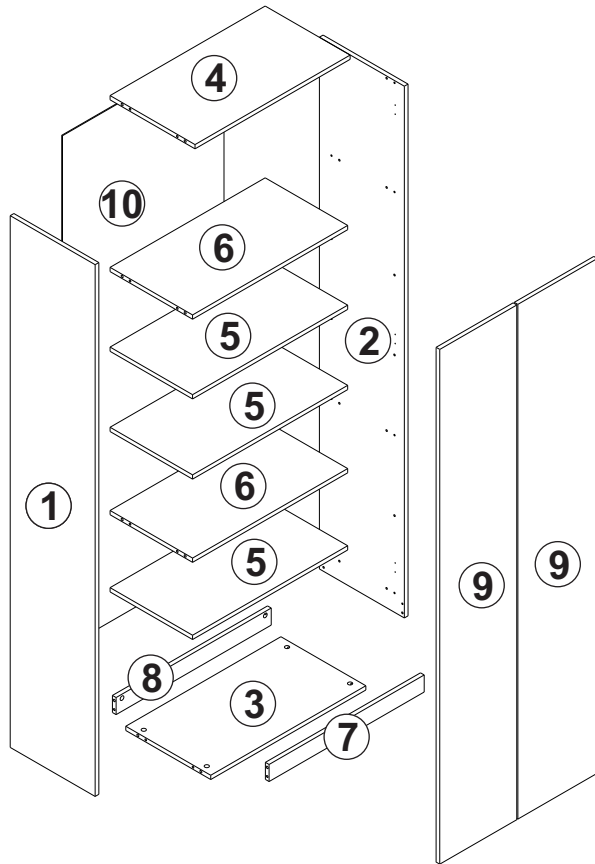

❸

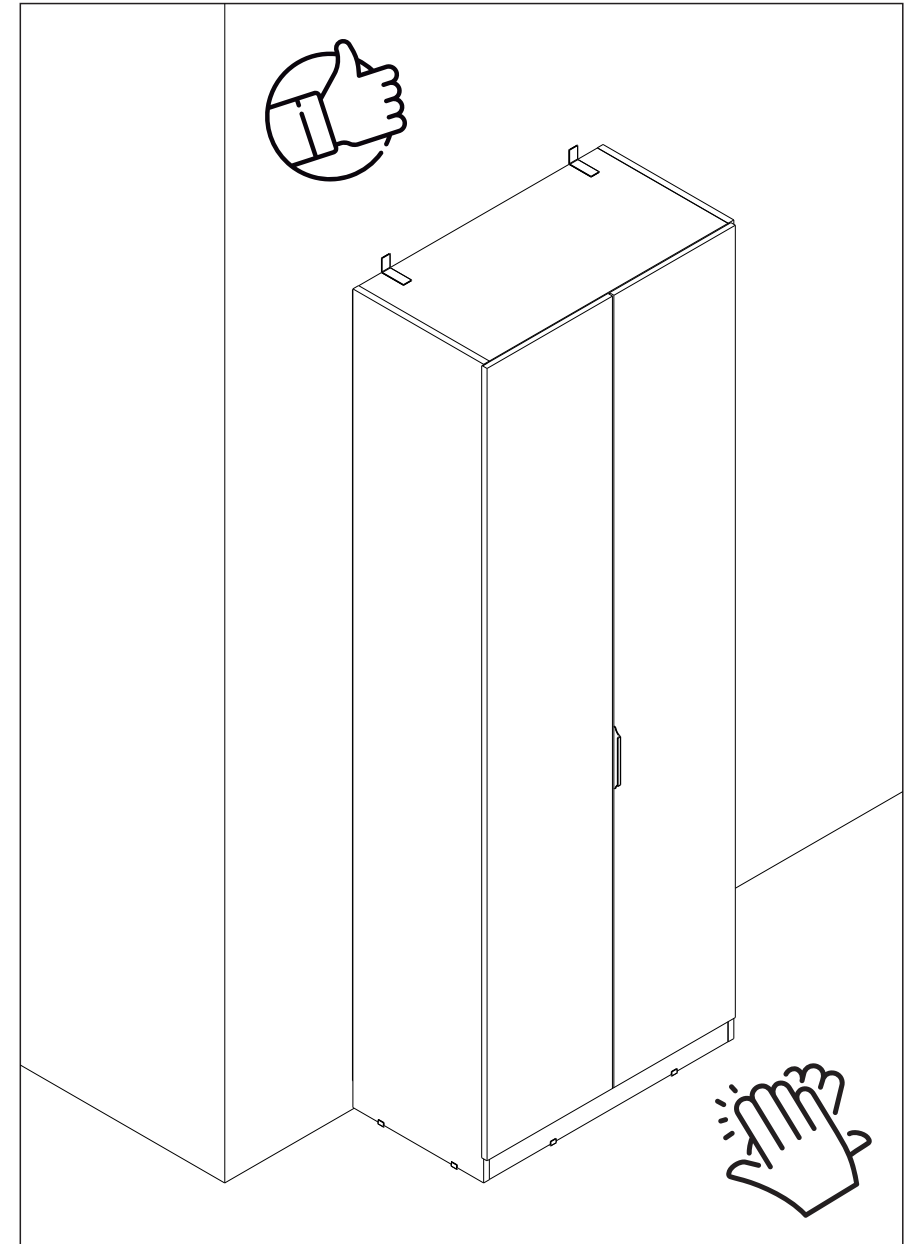

7

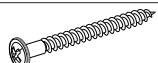
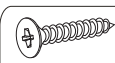
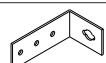
N- Bucha
ø8mm (2x)D- Parafuso
Ø4,5x60 (2x)E- Parafuso
Ø3,5x12 (4x)F- Suporte de
Fixação (2x)

Com o auxílio de uma furadeira + broca 8mm (não fornecido), fixar a bucha (N) na parede.

Prender o móvel com suporte de fixação (F) + parafuso (D), na parte superior do móvel, conforme desenho abaixo.



Cuidar para que o produto fique no esquadro durante a fixação na parede.

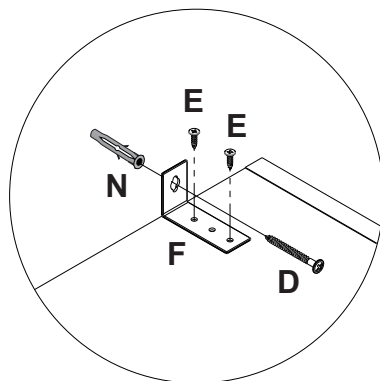
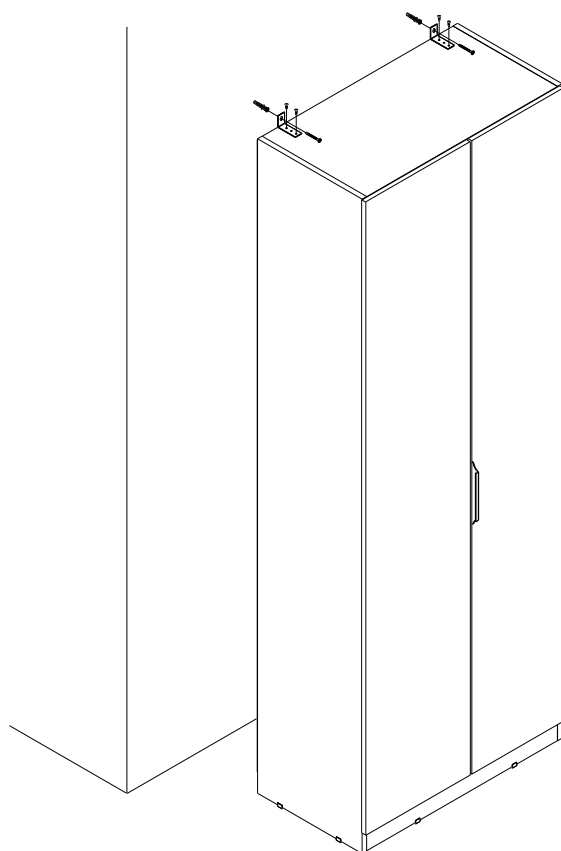

Para segurança, a fixação em paredes é imprescindível.

Componentes

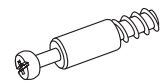

A- Minifix (20x)

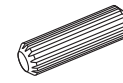
B- Cavilha
Ø6x30 (20x)

C- Tambor (20x)

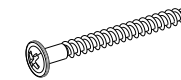
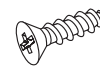
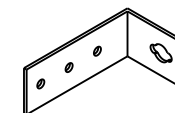
D- Parafuso
Ø4,5x60 (2x)E- Parafuso
Ø3,5x12 c.c. (40x)

F- Suporte de Fixação (2x)

G- Tapa Furo
Adesivo (16x)

H- Prego (40x)

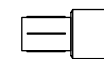
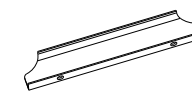

J- Sapatas (8x)

K- Suporte de
Prateleira (12x)

L- Puxador (1x)

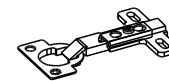
M- Dobradiça
com Pistão (6x)

N- Bucha Ø8mm (2x)

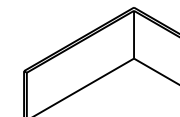

O- Proteção para suporte (2x)

Utilizar a régua abaixo para medir os componentes.

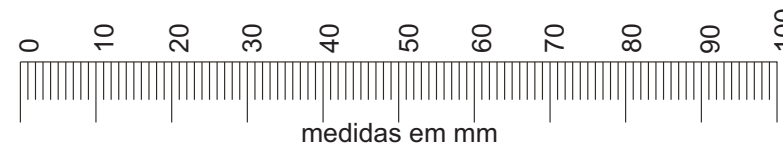

Pré-Montagem

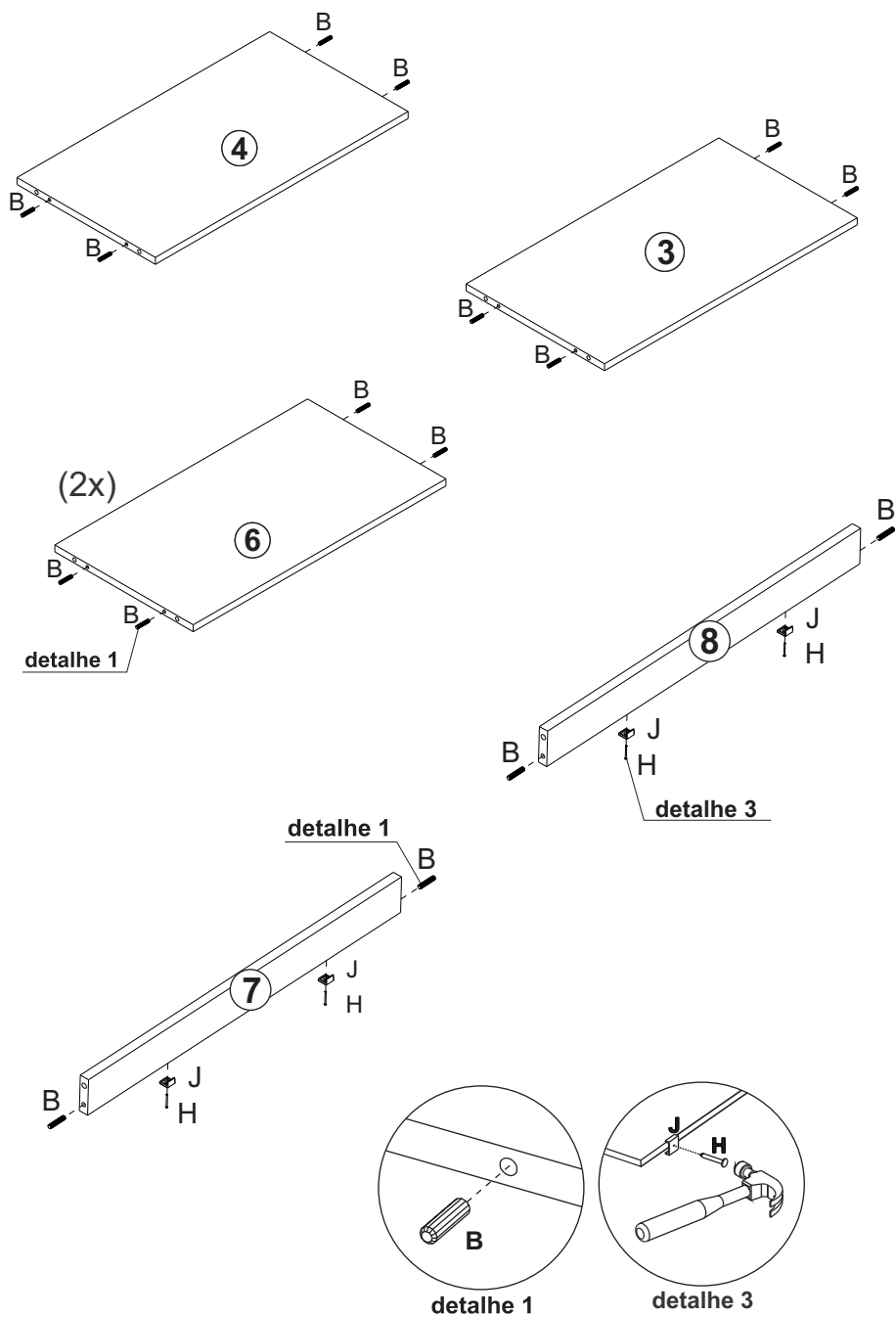

6

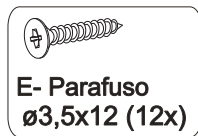

Montagem das portas, 2º passo:

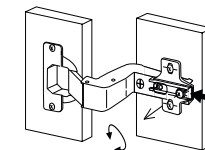
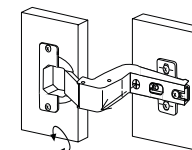
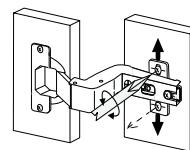
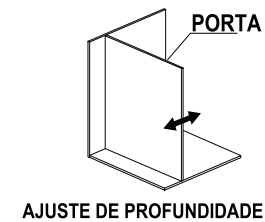
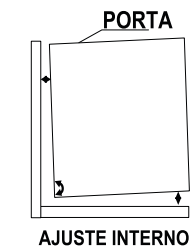
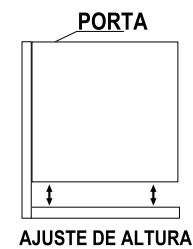
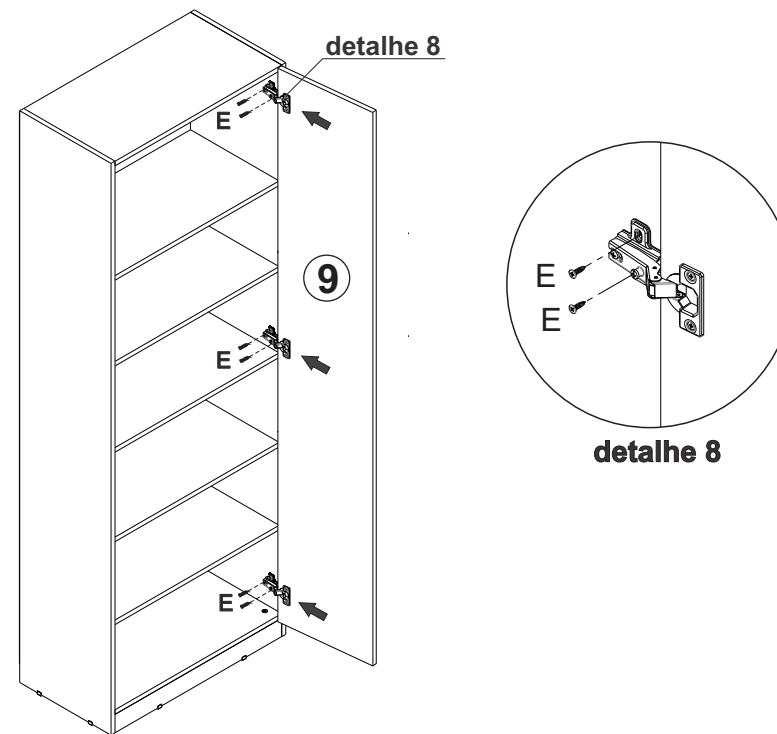

- 4** Colocar as prateleiras móveis como melhor se ajustar ao seu uso.

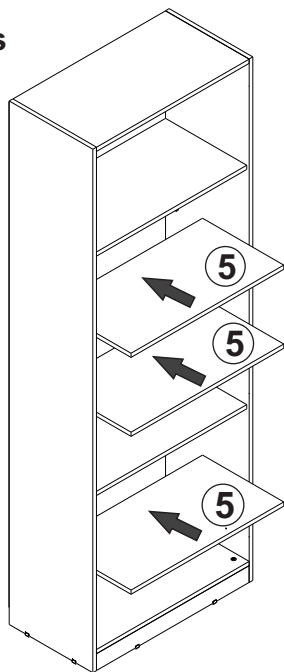

5

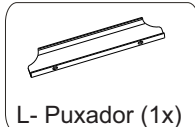
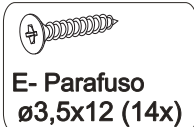

Montagem das portas, 1º passo:

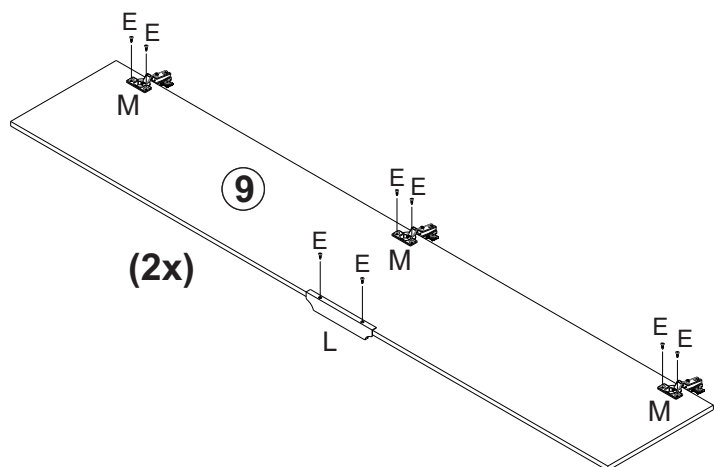

Pré-Montagem

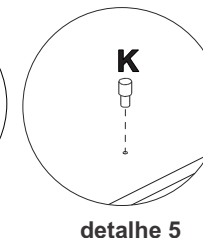
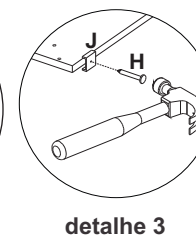
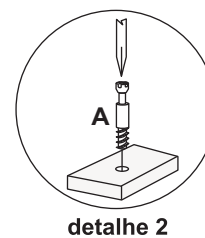
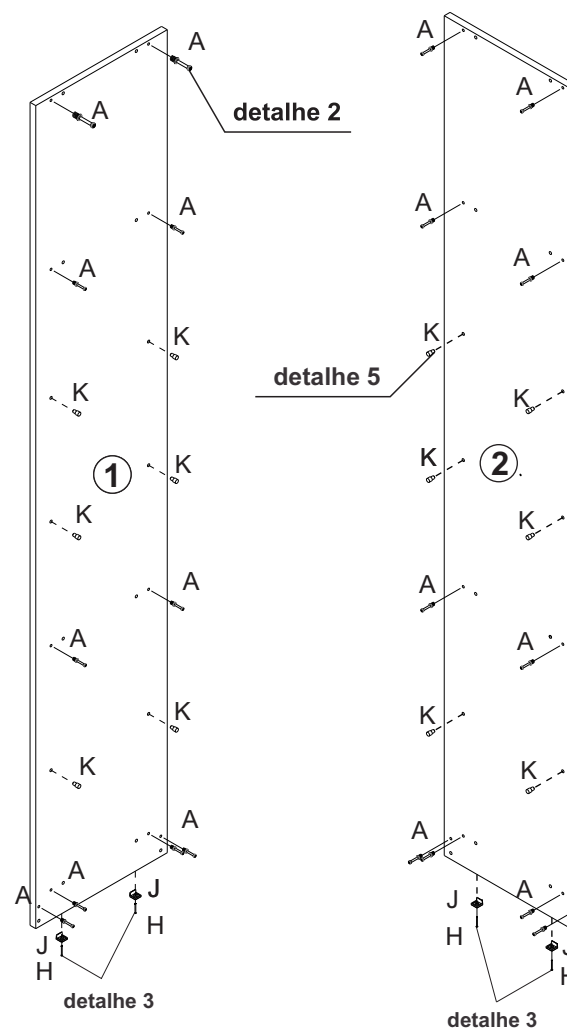

2

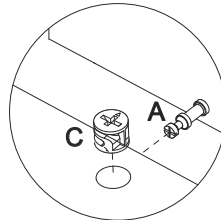
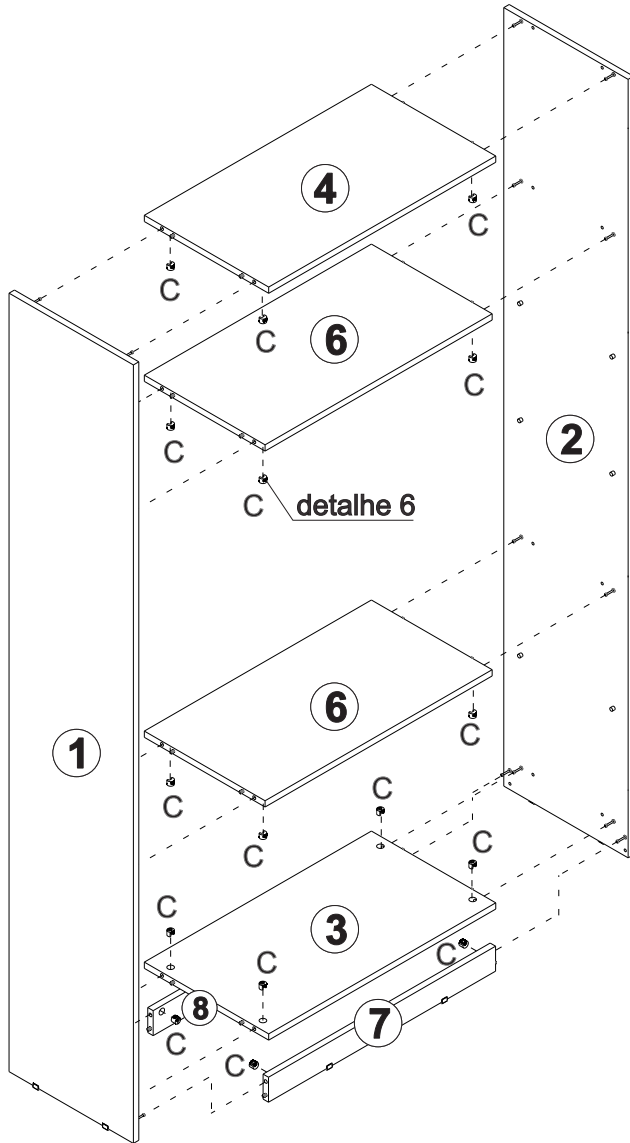
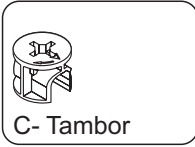

detalhe 6

Encaixar e girar os tambores (C) em sentido horário

3

