

HENNInd. e Com. de Móveis Henn
Mondai - SC - Brasil

☎ +55 49 3674.3500

📱 @moveishenn
www.henn.com.br**INSTRUÇÕES DE
MONTAGEM**INSTRUCCIONES DE MONTAJE
ASSEMBLY INSTRUCTIONS**Roupeiro Dubai 6 Portas 6 Gavetas | Armario Dubai 6 Puertas 6 Cajones |
Wardrobe Dubai 6 Doors 6 Drawers**

D322-207 Jequitibá HP/Verde HP

D322-208 Jequitibá HP/Preto HP

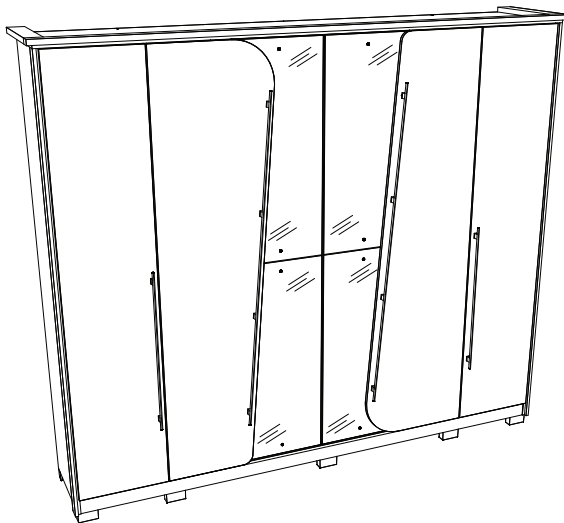
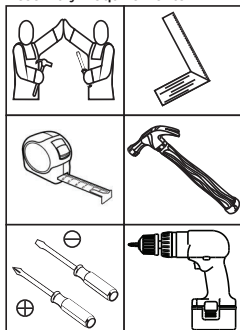
**Requisitos para montagem
Requisitos para la montaje
Assembly Requirements**

Imagens meramente ilustrativas,
não acompanha o produto.
Imágenes ilustrativas, no incluidas
con el producto.
Illustrative images, not included
with the product.

AVISO

Para limpeza de seu móvel, use uma flanela seca ou umedecida, e não utilize produtos químicos que possam danificar seu produto.

SISTEMA DE MONTAGEM

O sistema de montagem dos produtos, funciona de acordo com a ordem crescente dos números indicados no desenho. Ex: 01, 02, 03, 04... até a conclusão da montagem.

ASSISTÊNCIA TÉCNICA

Para solicitação de Assistência Técnica você consumidor deverá entrar em contato com o Lojista a qual você realizou a compra deste produto e solicitar a assistência técnica das peças avariadas. A garantia abrange todas as peças, partes e componentes que eventualmente venham apresentar defeito de fabricação no prazo de 03 (três) meses, contando a partir da entrega do produto ao consumidor, mediante nota fiscal de compra. Se houver qualquer alteração na estrutura do produto ou ocorrer defeito por negligência do montador/consumidor em relação a instrução de montagem e manuseio, não será fornecido assistência técnica gratuita.

ADVERTENCIA

Para limpeza de su móvil, use una flanela seca o húmeda, y no utilice productos químicos que puedan dañar su producto.

SISTEMA DE MONTAJE

El sistema de montaje de los productos funciona de acuerdo con el orden creciente de los números indicados en el dibujo. Ej.: 01, 02, 03, 04... hasta la conclusión del montaje.

ASISTENCIA TÉCNICA

Para solicitar Asistencia Técnica, el consumidor debe comunicarse con el Comercio que usted realizó la compra de este producto y solicita asistencia técnica para las partes dañadas. La garantía cubre todas las partes, piezas y componentes que eventualmente puedan presentar defecto de fabricación en el plazo de 03 (tres) meses, contados a partir de la entrega del producto al consumidor, mediante factura de compra. Si se produce algún cambio en la estructura del producto o se produce un defecto por negligencia del montador/consumidor en relación con las instrucciones de montaje y manipulación, no se prestará asistencia técnica gratuita.

NOTICE

To clean your furniture, use a dry or wet cloth, and do not use chemicals that may damage your product.

ASSEMBLY SYSTEM

The products' assembly system works according to the increasing order of the indicated numbers. For example: 01, 02, 03, 04 ... to the end of the assembly.

TECHNICAL ASSISTANCE

To request Technical Assistance, the consumer must contact the retailer from whom you purchased this product and request technical assistance for the damaged parts. The warranty covers all parts, parts and components that may eventually present a manufacturing defect within a period of 03 (three) months, counting from the delivery of the product to the consumer, by means of a purchase invoice. If there is any change in the structure of the product or defect occurs due to negligence of the assembler/consumer in relation to the assembly and handling instruction, free technical assistance will not be provided.

ACESSÓRIOS | ACCESORIOS | ACCESSORIES



x4



x12



x43



x21



x12



x10



x208



x92

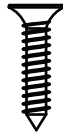

x12



x3



x3

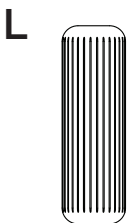

x132



x1



x4

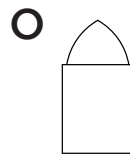

x3

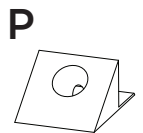

x12

Parafusos em escala
Tornillos escalados
Scaled screws

1:1

ACESSÓRIOS | ACCESORIOS | ACCESSORIES

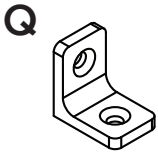

x19

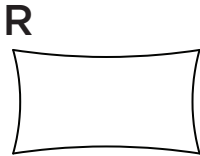

x3



x192

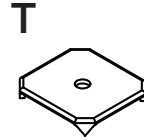

x54

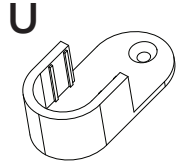

x4

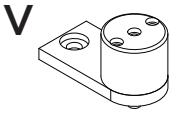

x12

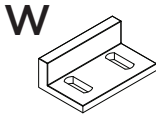

x4

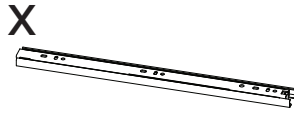

x6 Pares

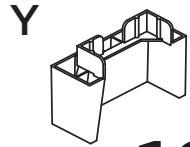

x10

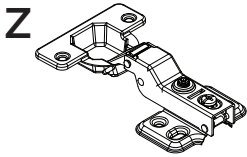

x24

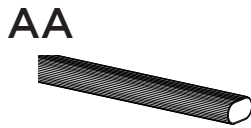

x2



x1



x2



x2

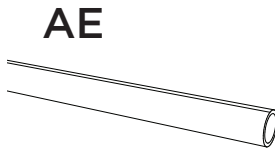

x2

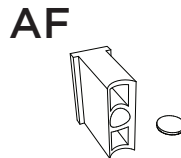

x1 Kit

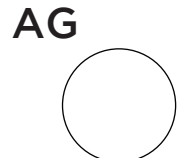

x4

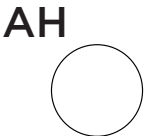

x72

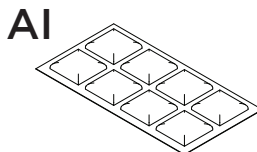

x8

LISTA DE PEÇAS | LISTA DE PIEZAS | LIST OF PIECES

Item	Caixa Caja Box	Qtd Ctd Qty	Descrição Descripción Description	Dimensões (mm) Dimensiones (mm) Dimensions (mm)		
				Comprimento Largo Length	Largura Ancho Width	Espessura Grosor Thickness
1	2/5	01	RODAPÉ FRONTAL FALDÓN DELANTERO FRONT SKIRTING	2567	73	15
2	2/5	03	TRAVESSA DO RODAPÉ PLACA DE RODAPIÉ SKIRTING PLATE	444	73	15
3	2/5	01	RODAPÉ TRASEIRO REPOSAPIÉS TRASERO BACK FOOTBOARD	2567	73	15
4	2/5	01	BASE BASE BASE	2567	480	15
5	1/5	01	DIVISÃO DIVISIÓN DIVISION	1693	460	15
6=10	3/5	01	TAMPO DAS GAVETAS TAPA DE LOS CAJONES TOP OF DRAWERS	826	400	15
7	2/5	01	DIVISÃO ESQUERDA DIVISIÓN IZQUIERDA LEFT	2122	480	15
8	1/5	01	CHÃO DO MALEIRO REPISA SUPERIOR FLOOR OF MALEIRO	1667	460	15
9	1/5	01	RIPA DO MALEIRO TRAVESAÑO SUPERIOR MALEIRO'S LATH	414	73	15
10=6	3/5	01	TAMPO DAS GAVETAS TAPA DE LOS CAJONES TOP OF DRAWERS	826	400	15
11	2/5	01	DIVISÃO DIREITA DIVISIÓN DERECHA RIGHT DIVISION	2122	480	15
12	3/5	08	PRATELEIRA ESTANTE SHELF	435	350	15
13	3/5	01	LATERAL ESQUERDA LATERAL IZQUIERDA LEFT SIDE	2210	480	15
14	3/5	01	LATERAL DIREITA LADO DERECHO RIGHT SIDE	2210	480	15
15	2/5	01	TAMPO TAPA TOP	2628	495	15
16	2/5	04	RIPA LATERAL RIPA LATERAL SIDE CLAPBOARD	525	80	25
17	2/5	02	MOLDURA LATERAL MARCO LATERAL LATERAL FRAME	2210	60	15
18	2/5	02	MOLDURA LATERAL SUPERIOR MARCO LATERAL SUPERIOR TOP SIDE FRAME	455	80	25
19	2/5	01	MOLDURA SUPERIOR MARCO SUPERIOR UPPER FRAME	2677	60	25
20	3/5	04	FUNDO FONDO BOTTOM	2152	416	3
21	3/5	02	FUNDO LATERAL FONDO LATERAL SIDE BACKGROUND	2152	455	3
22	4/5	02	PORTA ESPELHO SOPORTE ESPEJO MIRROR HOLDER	2116	445	15
23	4/5	04	ESPELHO ESPEJO MIRROR	1053	439	3
24	4/5	02	PORTA PUERTA DOOR	2124	445	15
25	5/5	02	PORTA USINADA PUERTA MECANIZADA MACHINED DOOR	2124	584	15
26	1/5	06	FRENTE DE GAVETA FRENTE DE CAJÓN DRAWER FRONT	770	170	15
27	1/5	12	LADO DE GAVETA LADO DEL CAJÓN SIDE OF DRAWER	350	122	15
28	3/5	06	FUNDO DE GAVETA RECORTADO FONDO DEL CAJÓN RECORTADO CROPPED DRAWER BOTTOM	732	361	3
29	1/5	06	RIPA DE TRÁS MALLA DETRÁS REAR LAHT	751	122	15

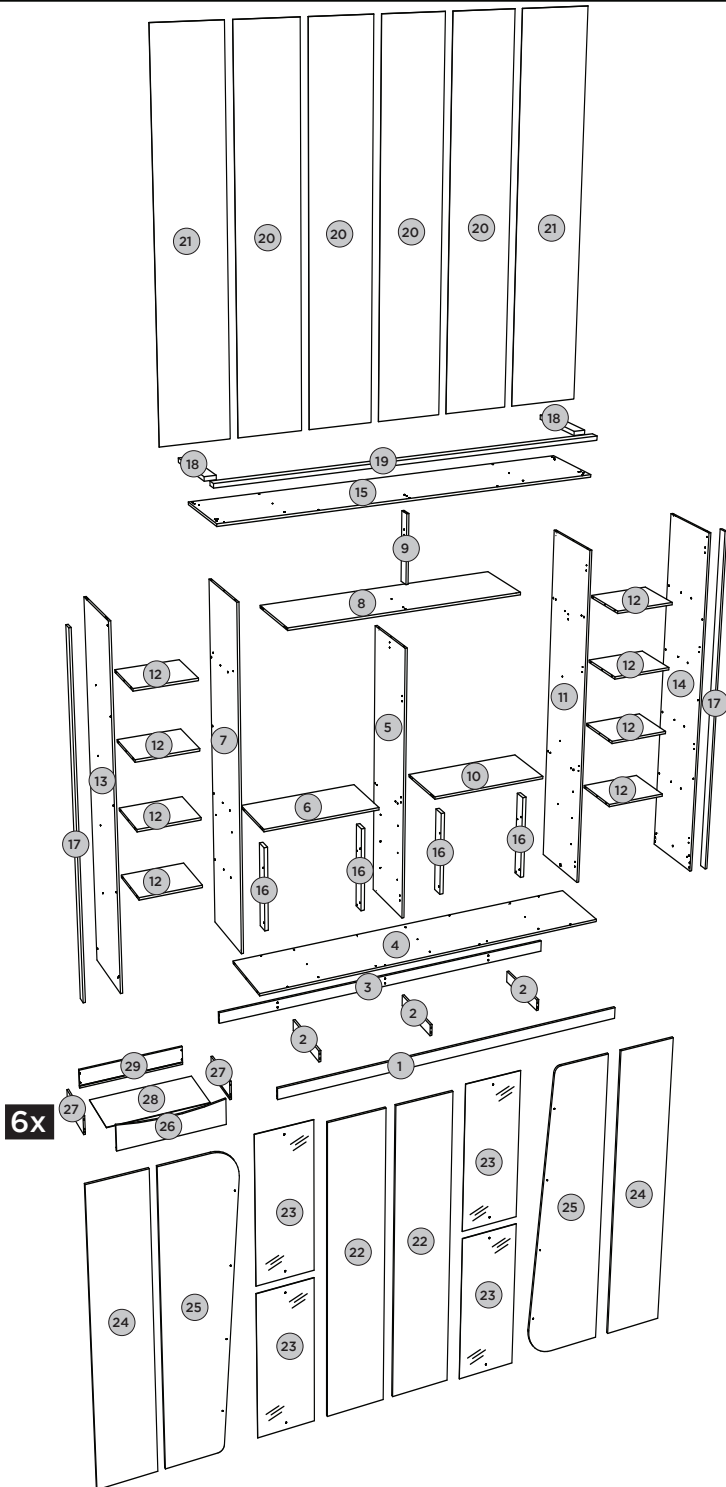

LISTA DE PEÇAS | LISTA DE PIEZAS | LIST OF PIECES



PASSO 1**PEÇAS REQUERIDAS**

1	RODAPÉ FRONTAL	x1
2	TRAVESSA DO RODAPÉ	x3
3	RODAPÉ TRASEIRO	x1

ACESSÓRIOS REQUERIDOS



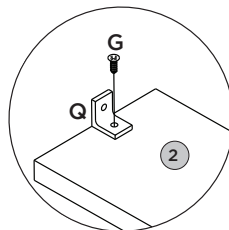
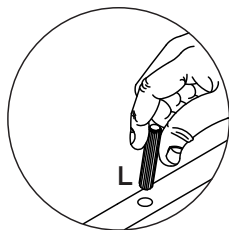
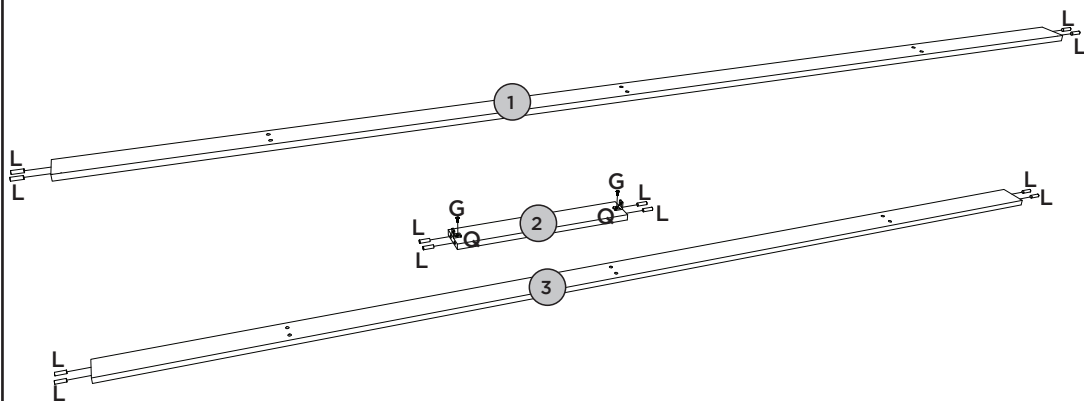
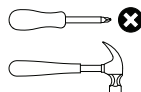

G		06
L		20
Q		06

FERRAMENTAS NECESSÁRIAS

PASSO 2**PEÇAS REQUERIDAS**

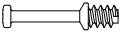
4	BASE	x1
15	TAMPO	x1

ACESSÓRIOS REQUERIDOS

G		08
J		03
L		02
N		04
W		04

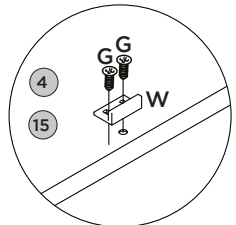
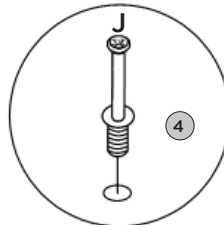
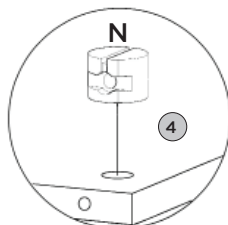
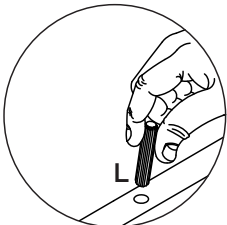
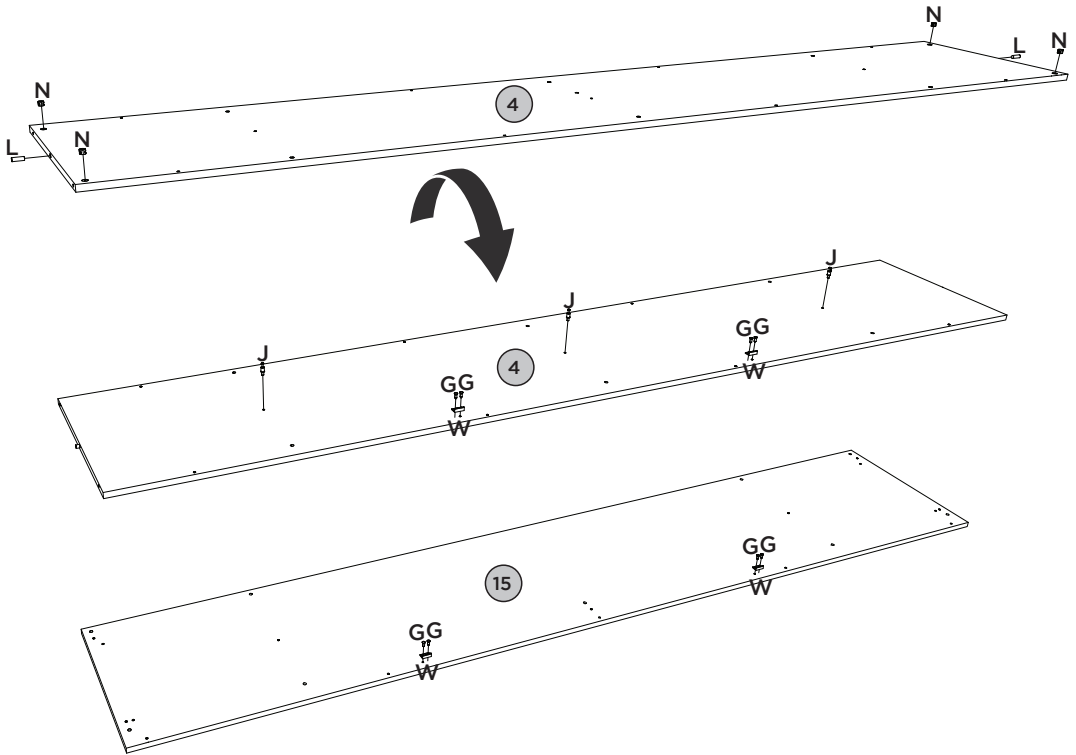
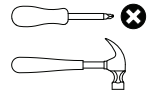
FERRAMENTAS NECESSÁRIAS





PASSO 3

ITM/D322-

PEÇAS REQUERIDAS

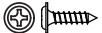
5	DIVISÃO	x1
7	DIVISÃO ESQUERDA	x1
11	DIVISÃO DIREITA	x1

ACESSÓRIOS REQUERIDOS

G		12
H		08
L		12
U		04
V		12

FERRAMENTAS NECESSÁRIAS

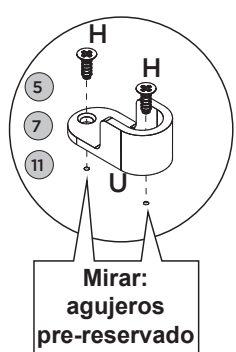
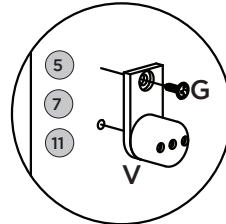
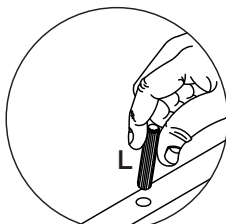
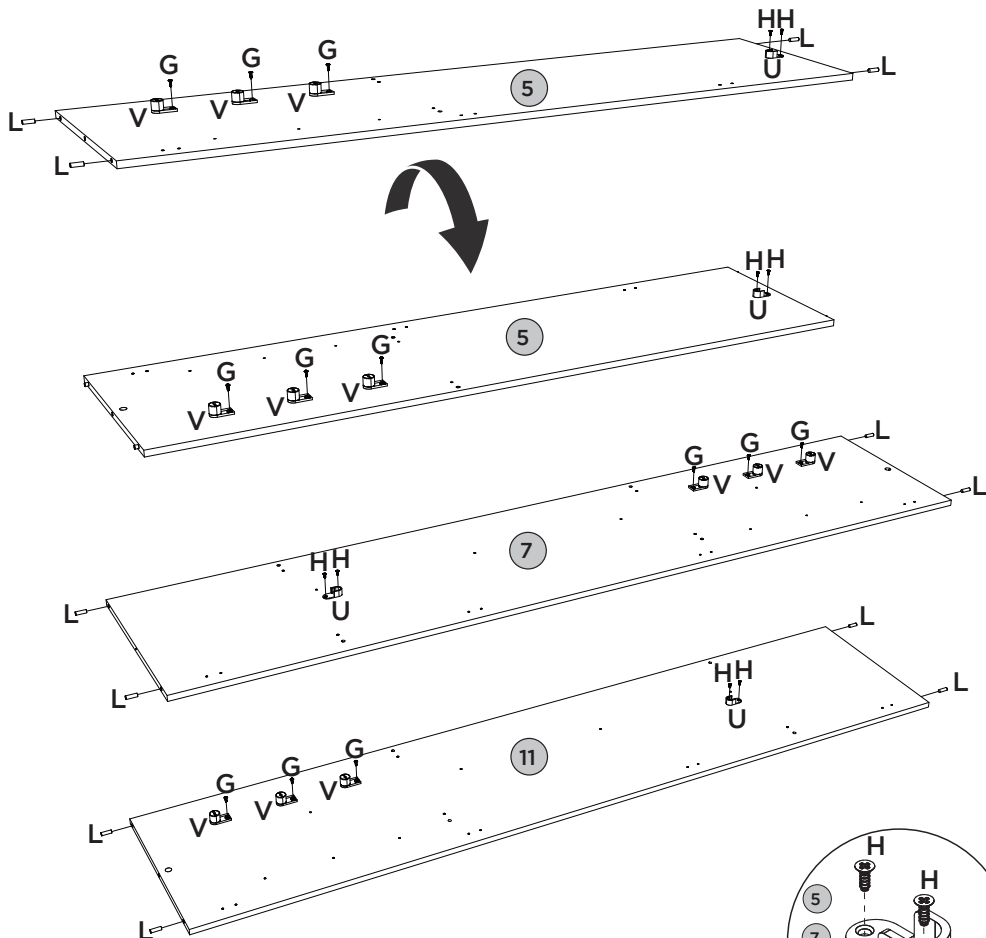
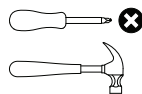

Mirar:
agujeros
pre-reservado

PASSO 4**PEÇAS REQUERIDAS**

6=10	TAMPO DAS GAVETAS	x2
8	CHÃO DO MALEIRO	x1
9	RIPA DO MALEIRO	x1
12	PRATELEIRA	x8
13	LATERAL ESQUERDA	x1
14	LATERAL DIREITA	x1

ACESSÓRIOS REQUERIDOS

L		50
---	---	----

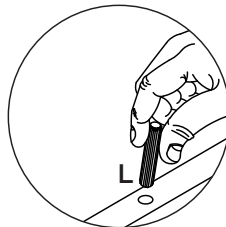
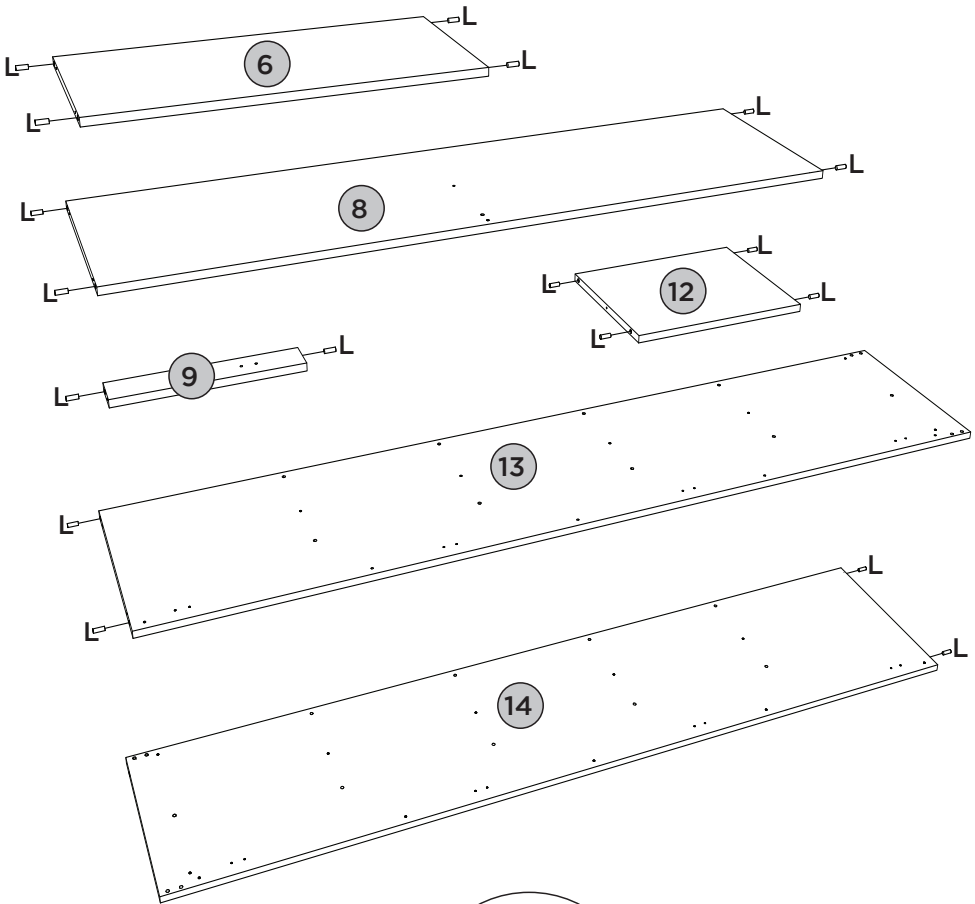
FERRAMENTAS NECESSÁRIAS

PASSO 5**PEÇAS REQUERIDAS**

1	RODAPÉ FRONTAL	x1
2	TRAVESSA DO RODAPÉ	x3
3	RODAPÉ TRASEIRO	x1

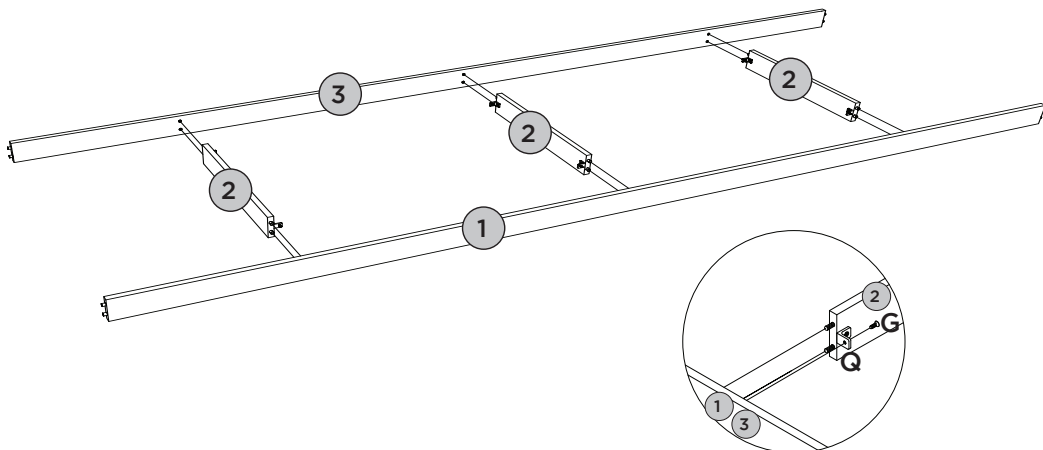
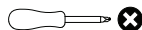

ACESSÓRIOS REQUERIDOS

G		06
---	---	----

FERRAMENTAS NECESSÁRIAS**PASSO 6****PEÇAS REQUERIDAS**

4	BASE	x1
---	------	----

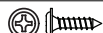
ACESSÓRIOS REQUERIDOS

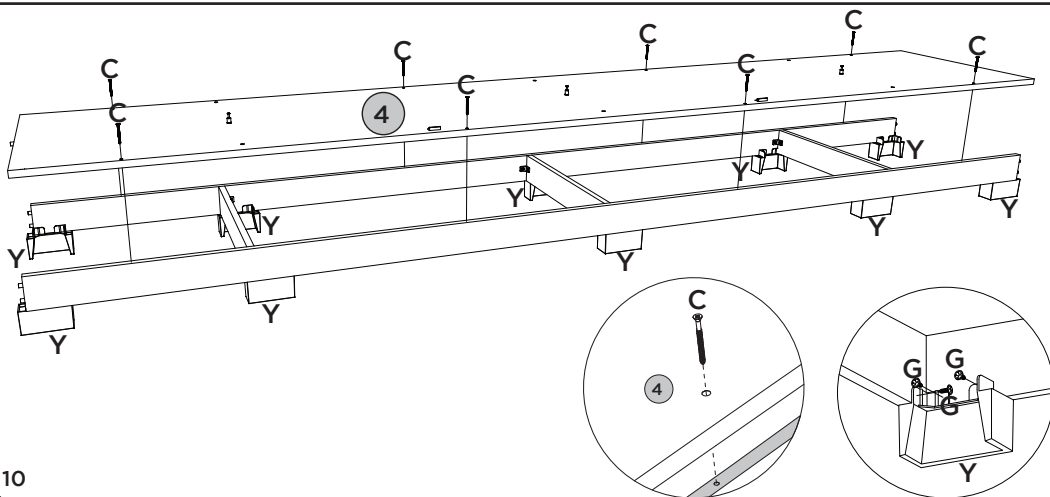

C		08
G		30
Y		10

FERRAMENTAS NECESSÁRIAS

PASSO 7**PEÇAS REQUERIDAS**

5	DIVISÃO	x1
6	TAMPO DAS GAVETAS	x1
7	DIVISÃO ESQUERDA	x1

ACESSÓRIOS REQUERIDOS

C		04
K		02

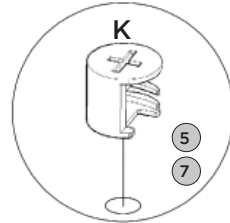
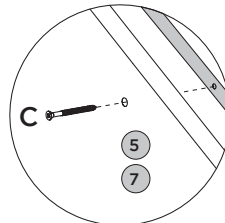
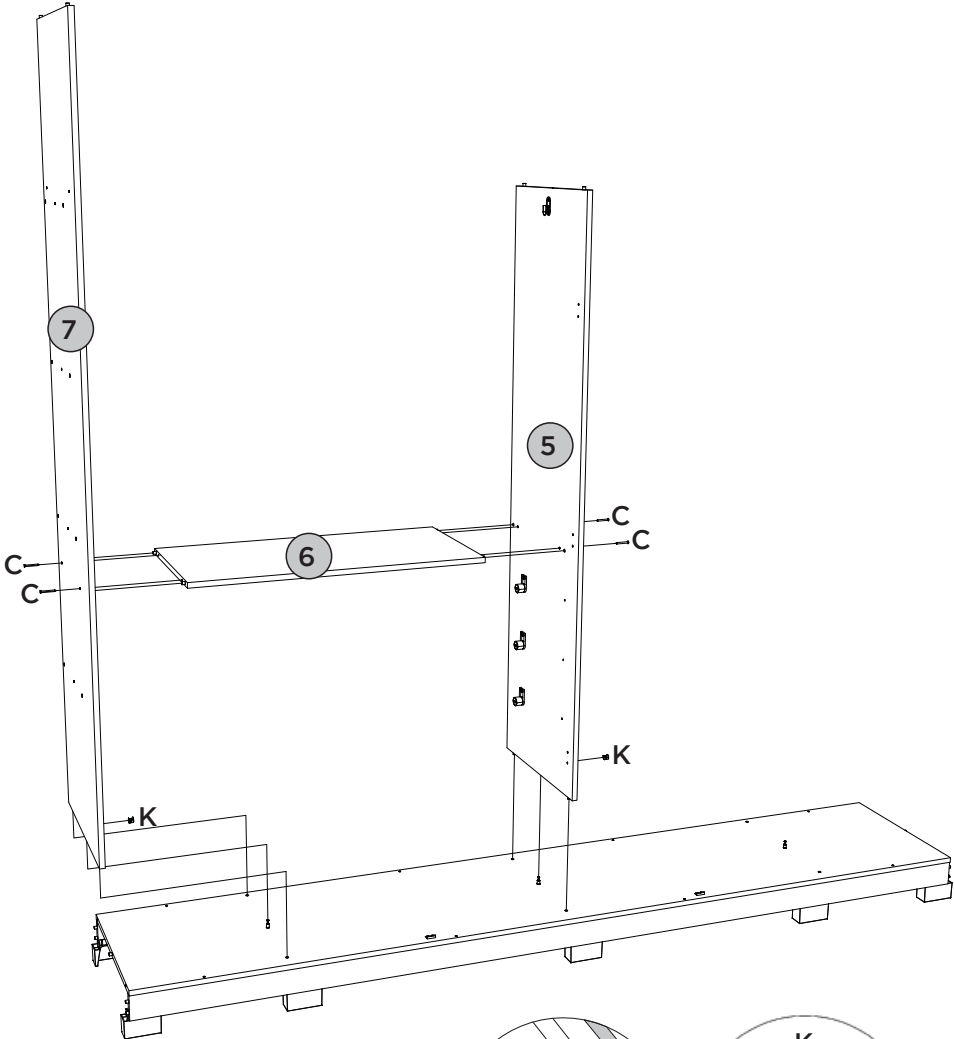
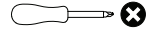
FERRAMENTAS NECESSARIAS

PEÇAS REQUERIDAS

8	CHÃO DO MALEIRO	x1
9	RIPA DO MALEIRO	x1
10=6	TAMPO DAS GAVETAS	x1
11	DIVISÃO DIREITA	x1

ACESSÓRIOS REQUERIDOS

C		08
G		02
K		01
Q		01

FERRAMENTAS NECESSÁRIAS

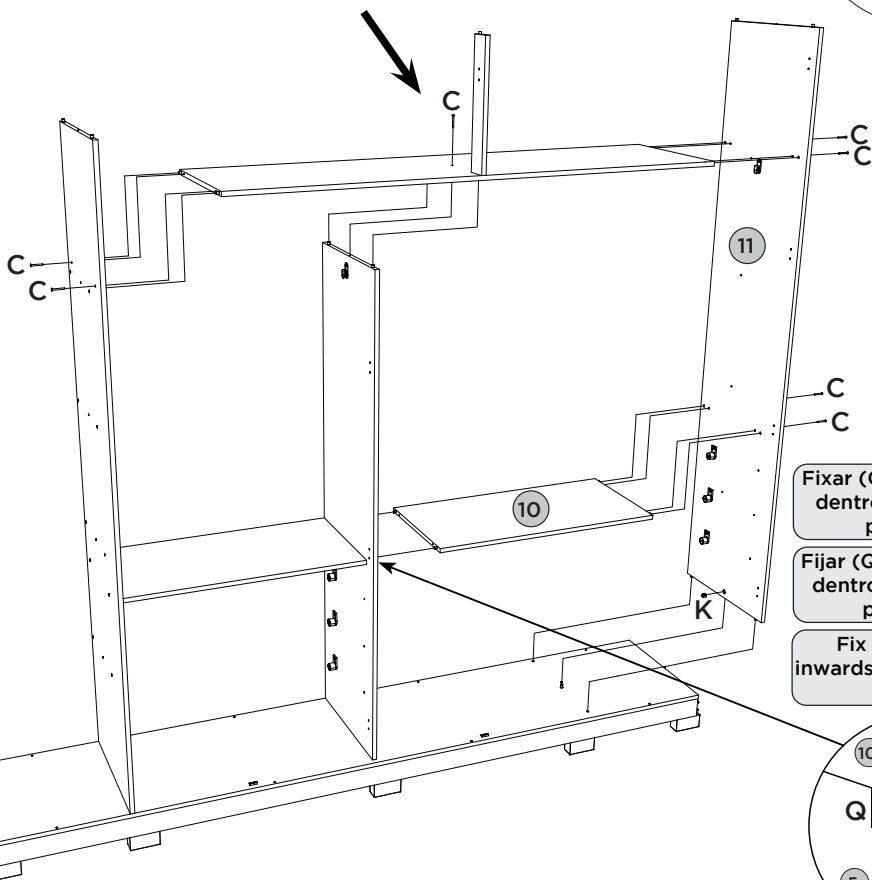
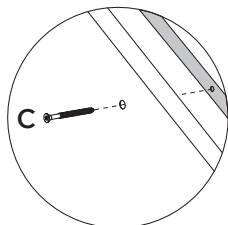
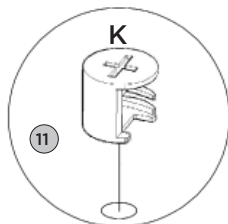
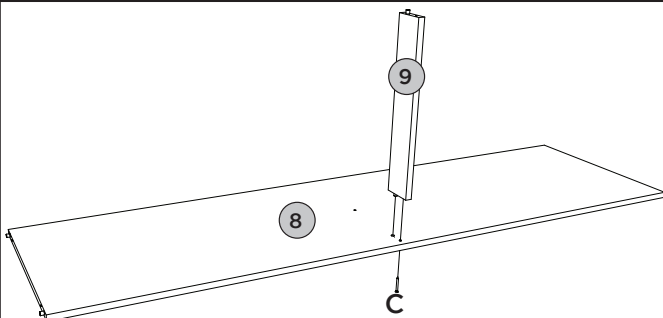
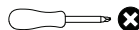

Fixar (Q) 120mm para dentro, embaixo da peça (10)

Fijar (Q) 120mm hacia dentro, debajo de la pieza (10)

Fix (Q) 120mm inwards, under the part (10)

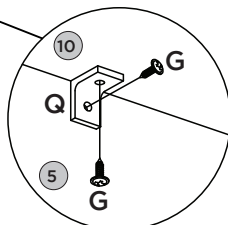





PASSO 9

PEÇAS REQUERIDAS

12	PRATELEIRA	x4
13	LATERAL ESQUERDA	x1

ACESSÓRIOS REQUERIDOS

A			02
C			08

FERRAMENTAS NECESSÁRIAS

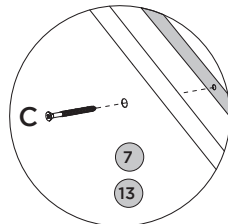
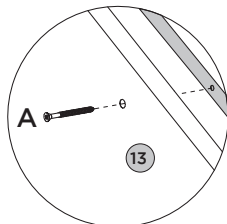
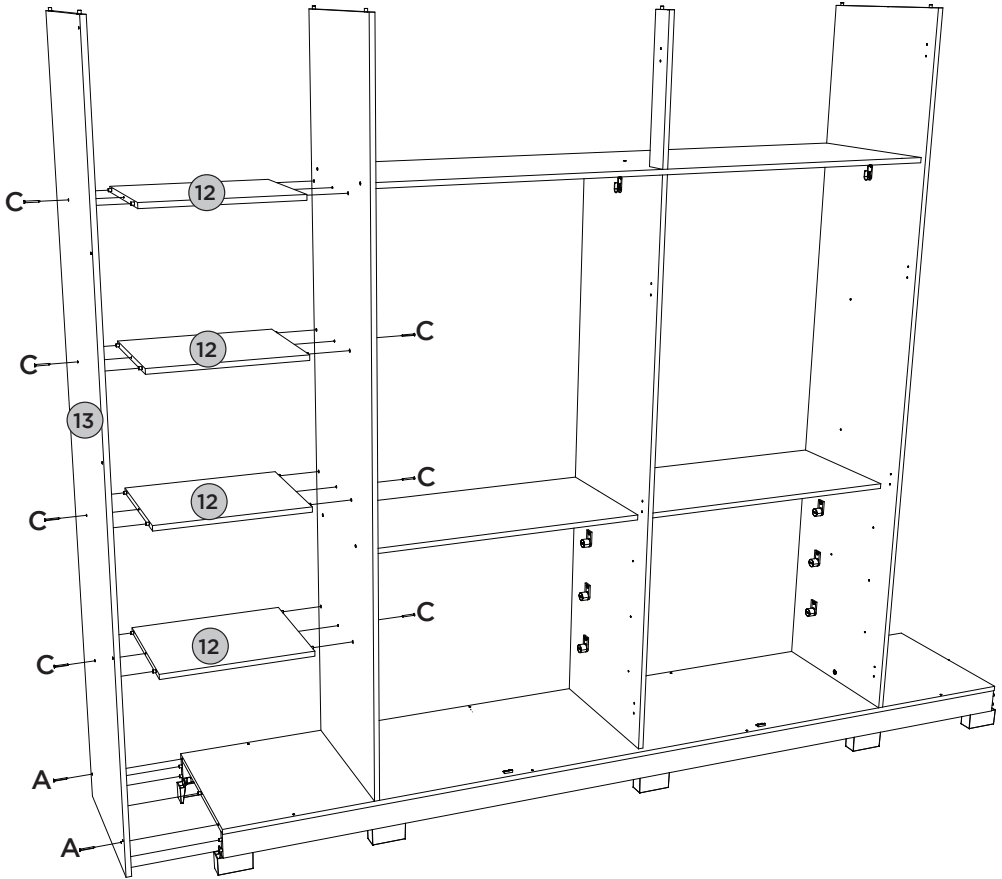
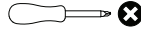



PASSO 10

ITM/D322-

PEÇAS REQUERIDAS

12	PRATELEIRA	x4
14	LATERAL DIREITA	x1

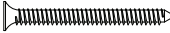
ACESSÓRIOS REQUERIDOS

A			02
C			08

FERRAMENTAS NECESSÁRIAS

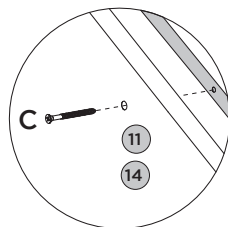
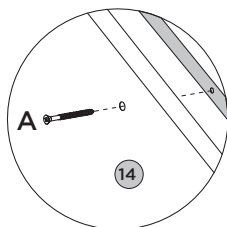
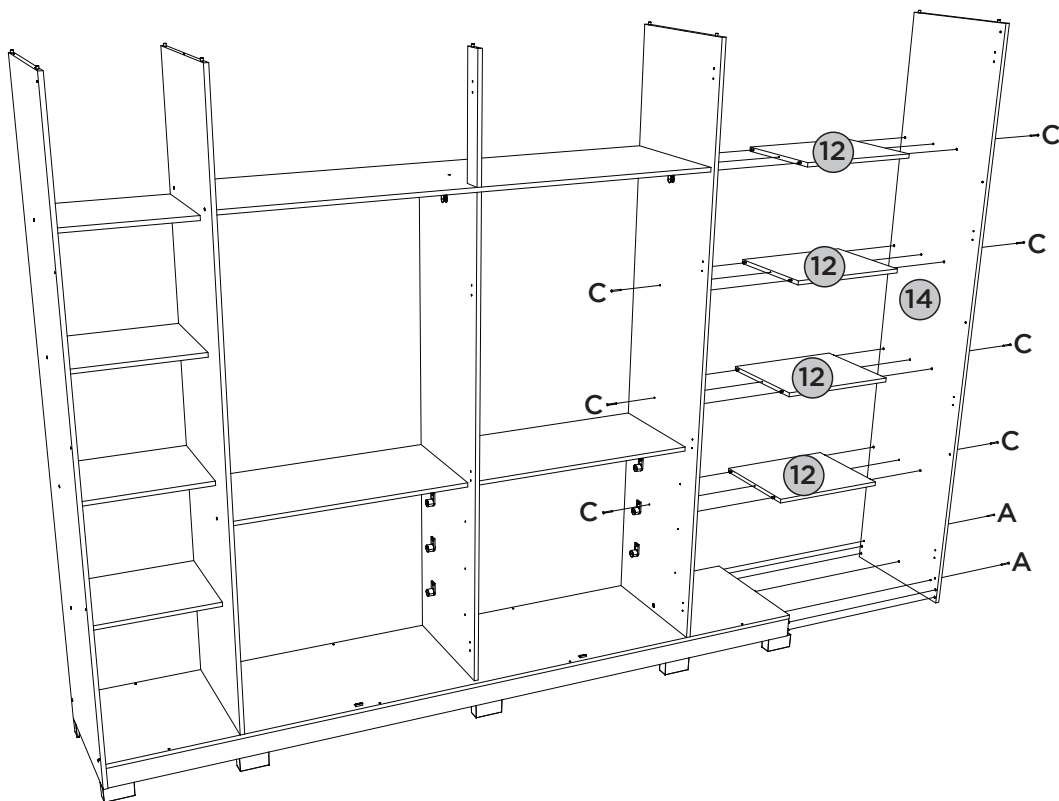



PASSO 11

PEÇAS REQUERIDAS

15	TAMPO	x1
16	RIPA LATERAL	x4

ACESSÓRIOS REQUERIDOS

C		07
D		12



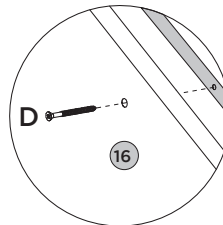
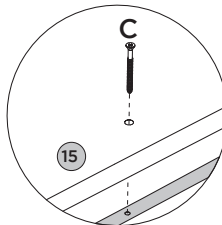
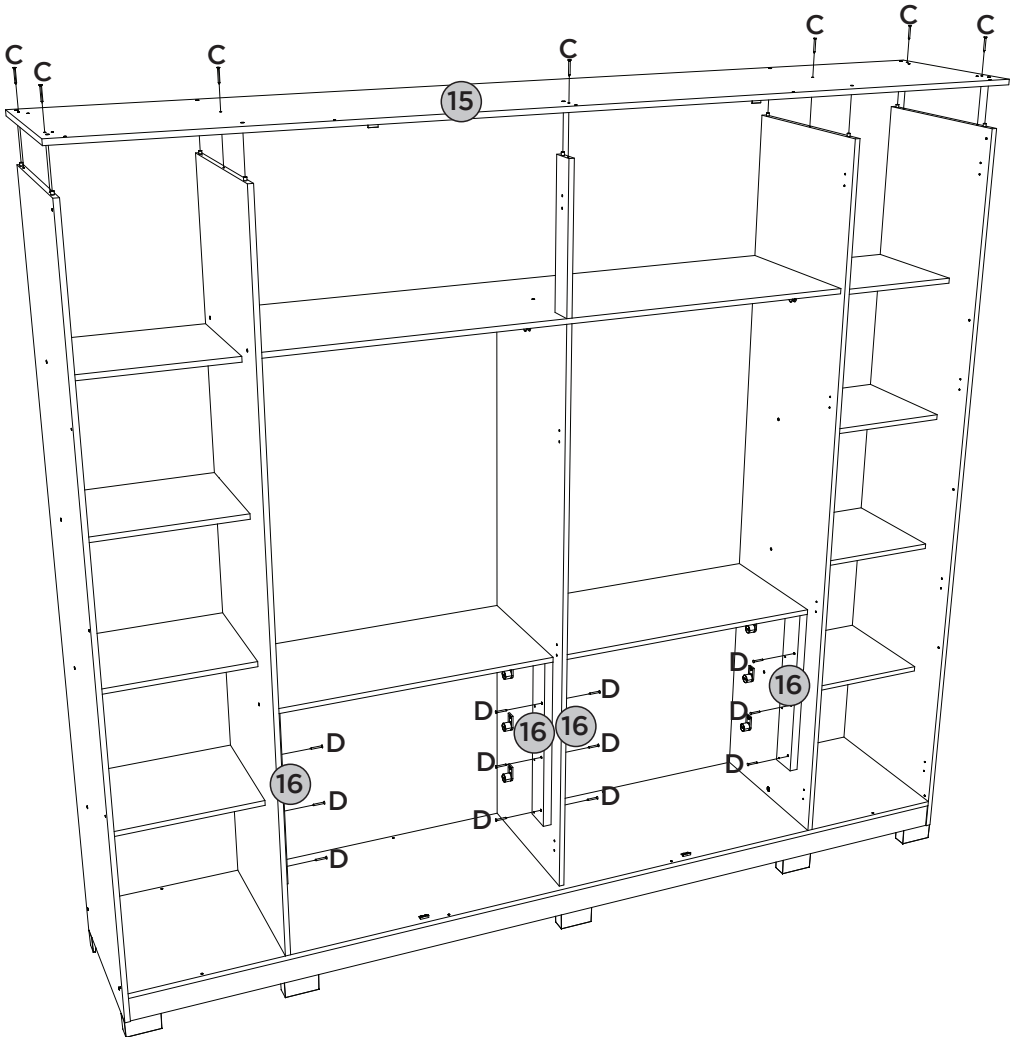
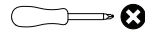



FERRAMENTAS NECESSÁRIAS

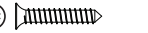

PEÇAS REQUERIDAS

17	MOLDURA LATERAL	x2
18	MOLDURA LATERAL SUP	x2
19	MOLDURA SUPERIOR	x1

ACESSÓRIOS REQUERIDOS

D			09
F			10
H			24
X			12

FERRAMENTAS NECESSÁRIAS

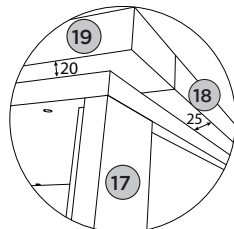
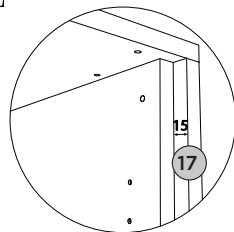
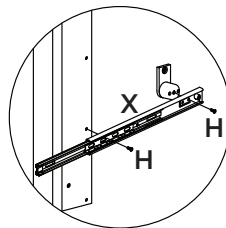
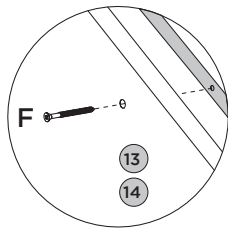
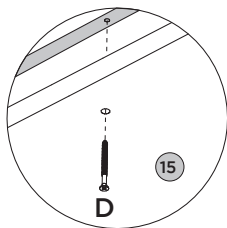
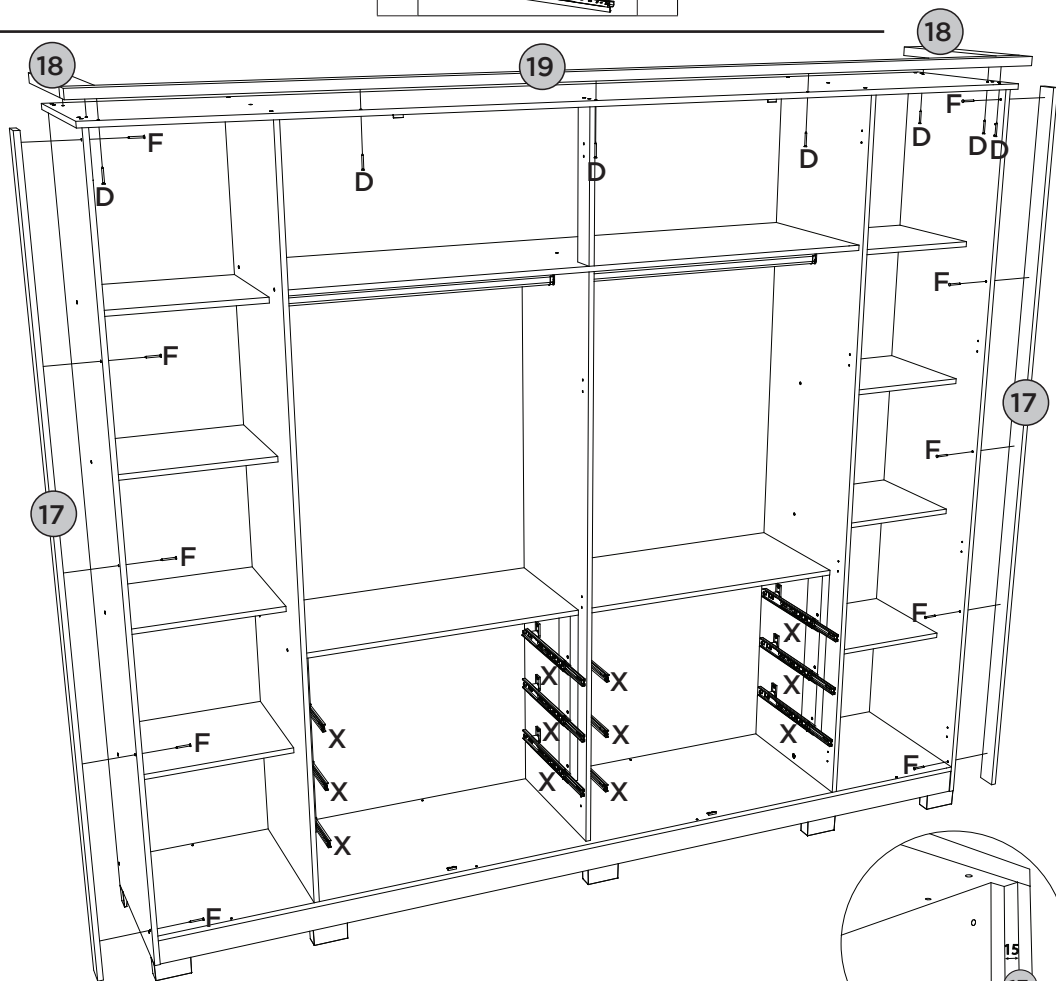
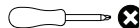





PASSO 13

PEÇAS REQUERIDAS

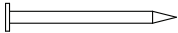
20	FUNDO	x4
21	FUNDO LATERAL	x2

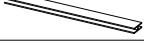
ACESSÓRIOS REQUERIDOS

S		192
T		54
AB		01
AC		02

FERRAMENTAS NECESSÁRIAS

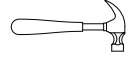

Fixar os pregos a uma distância de 100mm de um para outro.

Fijar las uñas a un distancia de 100mm uno a otro.



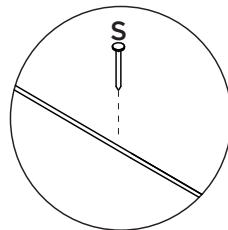
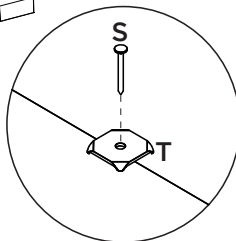
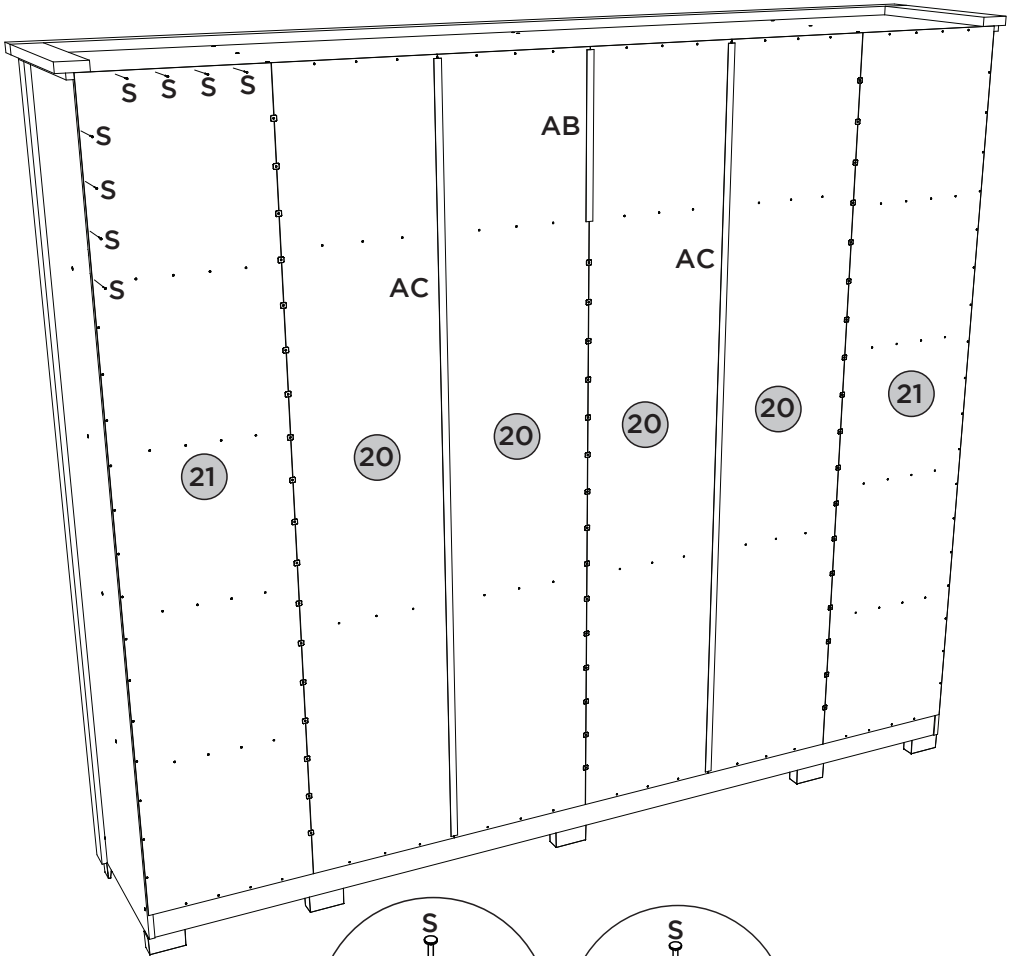

Fix the nails at a distance of 100mm from one to the other.





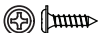

PEÇAS REQUERIDAS

22	PORTA ESPELHO	x2
23	ESPELHO	x4
24	PORTA	x2
25	PORTA USINADA	x2

ACESSÓRIOS REQUERIDOS

G		48
Z		24
AD		02
AE		02

FERRAMENTAS NECESSÁRIAS

		
AF		08
AI		08

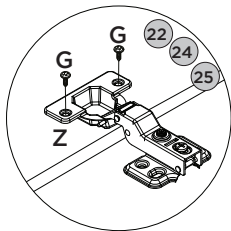
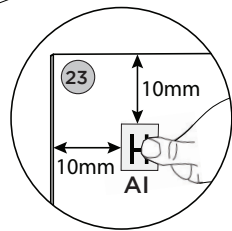
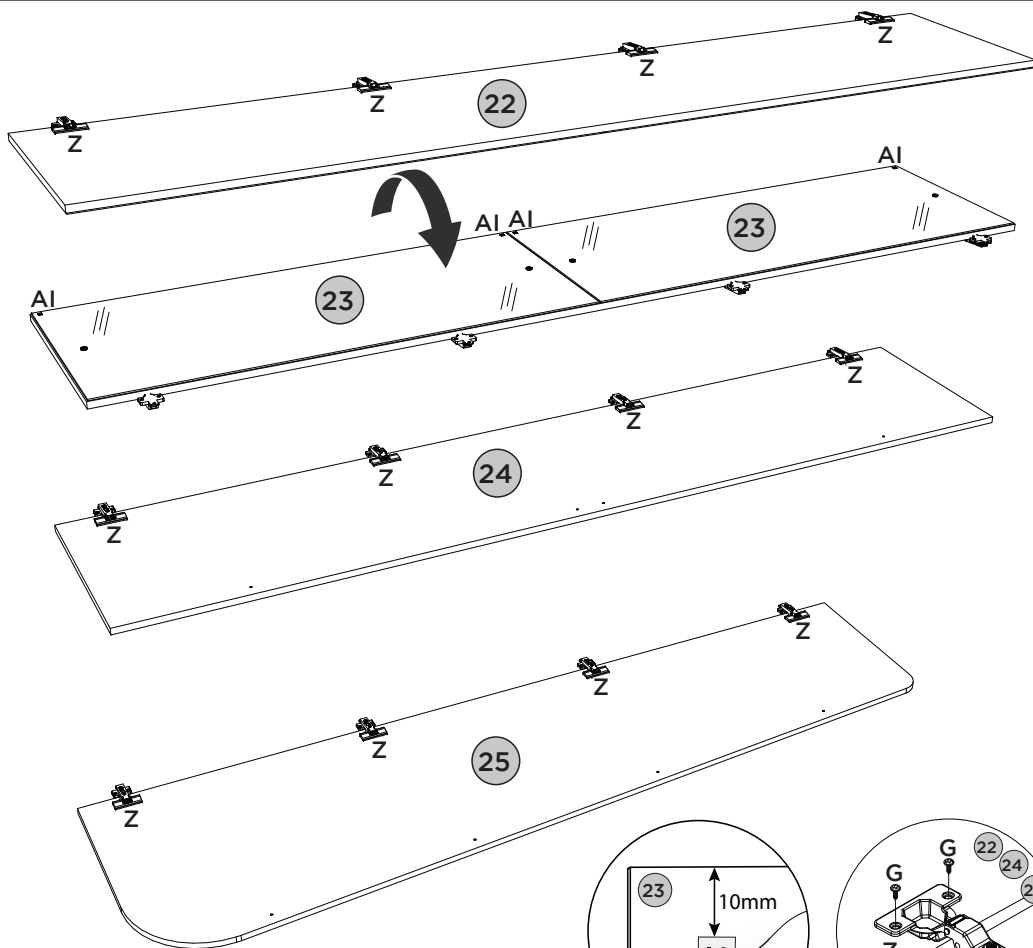



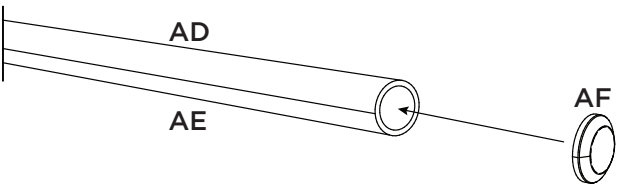

- Montagem do Puxador (AD) e (AE)
- Ensamblaje de la manija (AD) y (AE)
- Handle Assembly (AD) and (AE)







PEÇAS REQUERIDAS

22	PORTA ESPELHO	x2
23	ESPELHO	x4
24	PORTA	x2

ACESSÓRIOS REQUERIDOS

B		04
G		64
Z		16
AA		02

FERRAMENTAS NECESSÁRIAS

		
AD		02
AF		04
AH		08

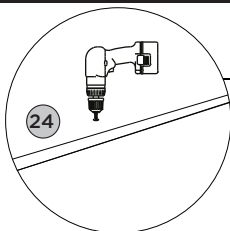

Para porta (24): fazer furação passante para puxador (AD)

Para la puerta (24): hacer agujeros pasantes para la manija (AD)

For door (24): make through holes for handle (AD)

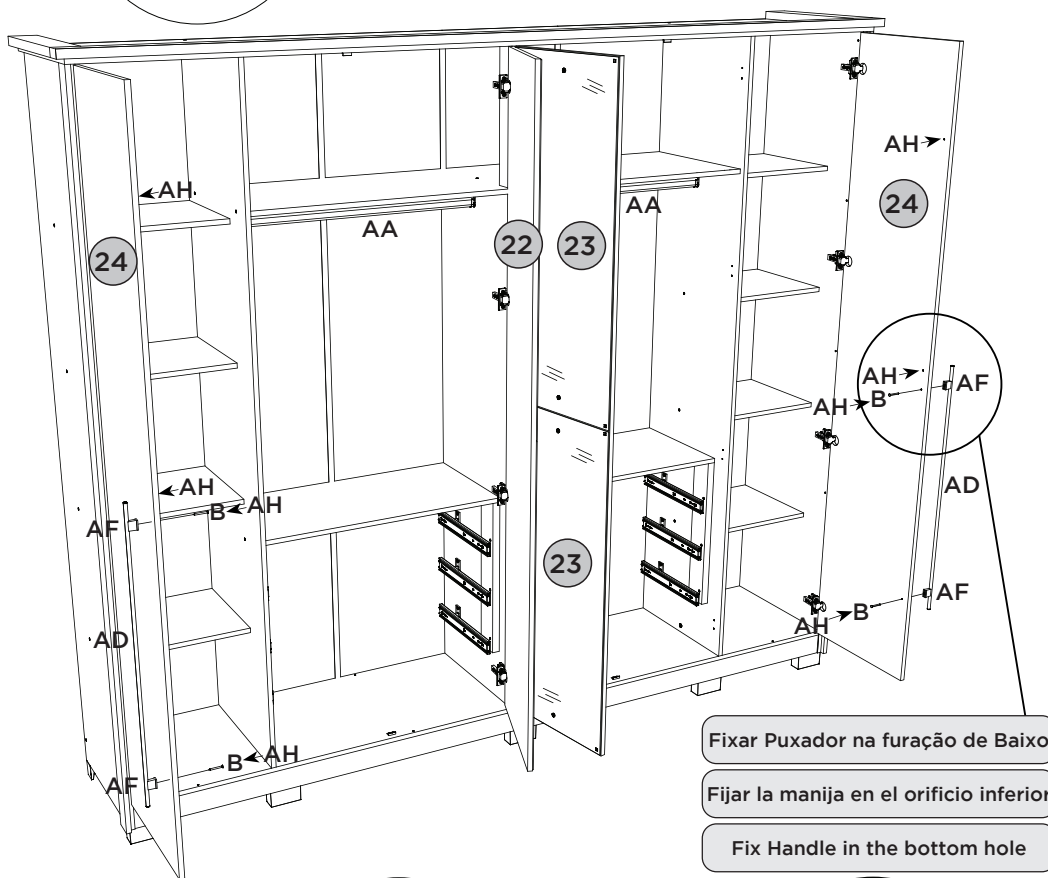

Fixar Puxador na furação de Baixo

Fijar la manija en el orificio inferior

Fix Handle in the bottom hole

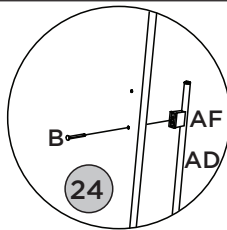
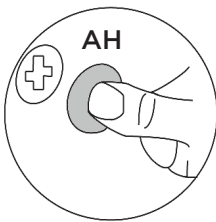
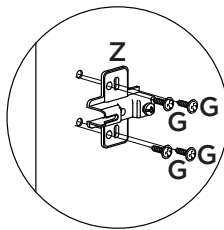
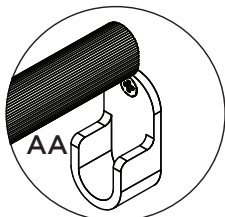

PEÇAS REQUERIDAS

25	PORTA USINADA	x2
----	---------------	----

ACESSÓRIOS REQUERIDOS

B		08
G		32
Z		08
AE		02
AF		08
AH		08

FERRAMENTAS NECESSÁRIAS

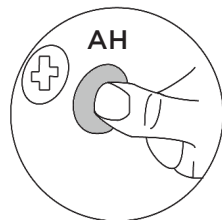
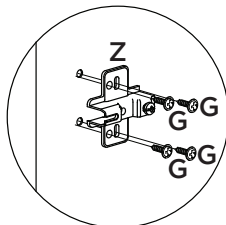
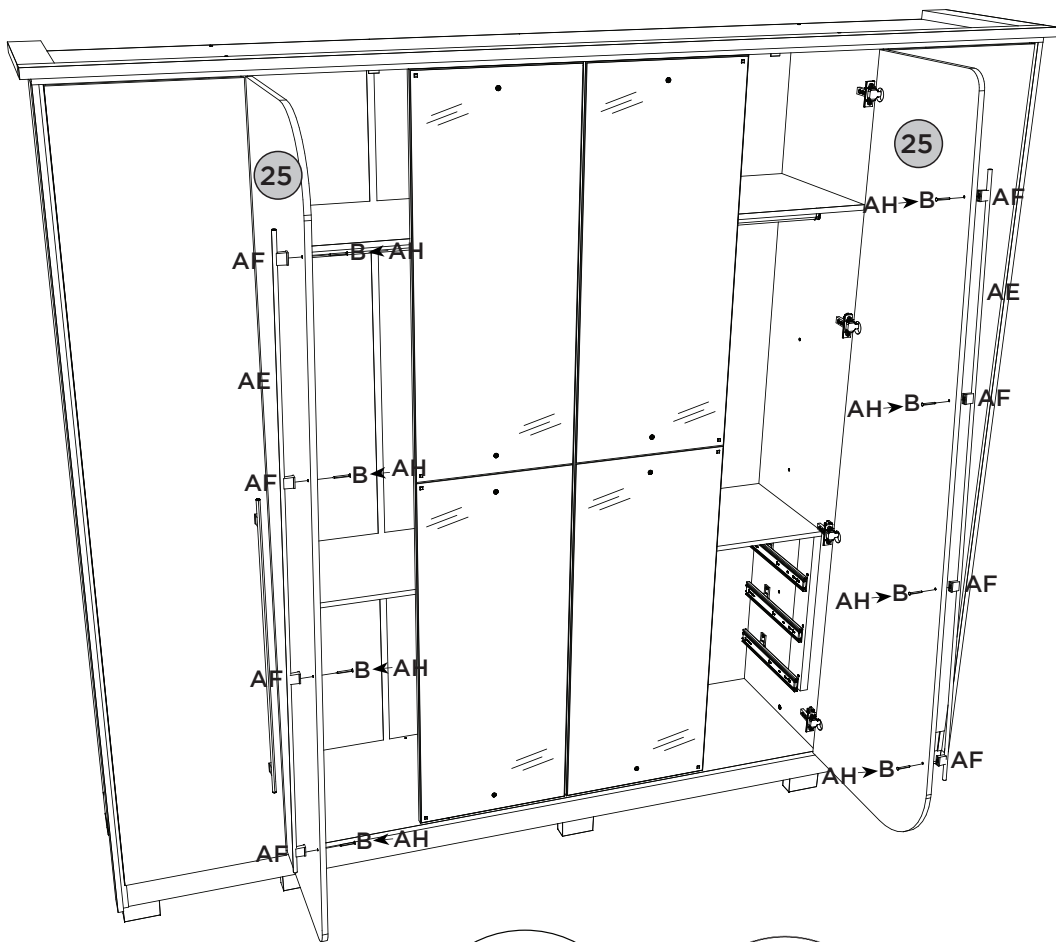
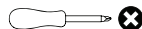



PASSO 17

PEÇAS REQUERIDAS

27	LADO DE GAVETA	x12
----	----------------	-----

ACESSÓRIOS REQUERIDOS

L		48
R		

FERRAMENTAS NECESSÁRIAS

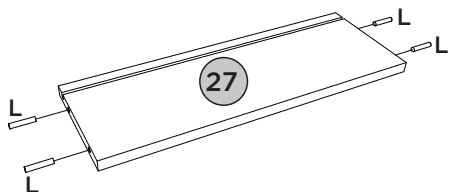

PASSO 18

PEÇAS REQUERIDAS

26	FRENTE DE GAVETA	x6
27	LADO DE GAVETA	x12
28	FUNDO DE GAVETA RECORTADO	x6

ACESSÓRIOS REQUERIDOS

R		
---	---	--

6x

1º

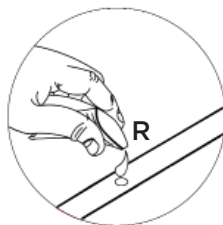
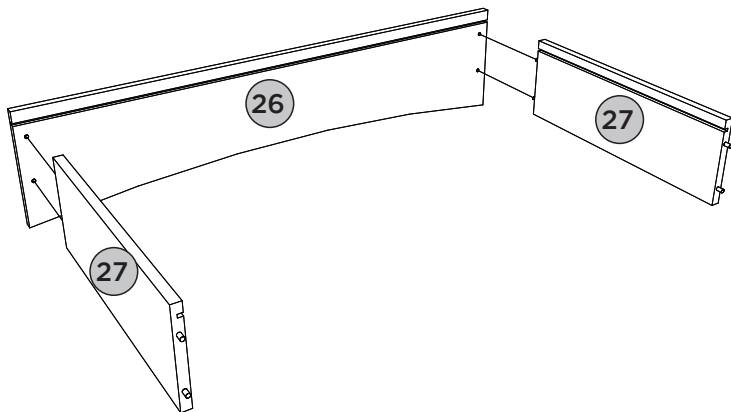

6x

2º

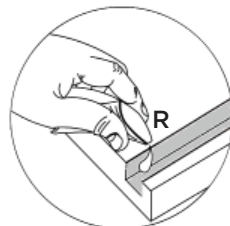
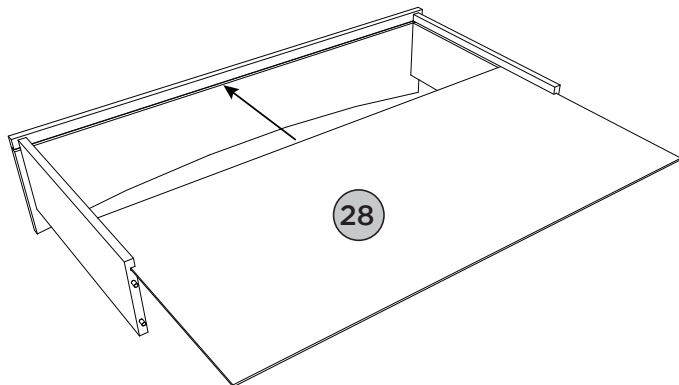





PASSO 19





PEÇAS REQUERIDAS

29	RIPA DE TRÁS	x6
----	--------------	----

ACESSÓRIOS REQUERIDOS

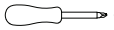
E		12
H		60
I		12
P		12

FERRAMENTAS NECESSÁRIAS

		X
Q		12
R		
X		12

6x

3º

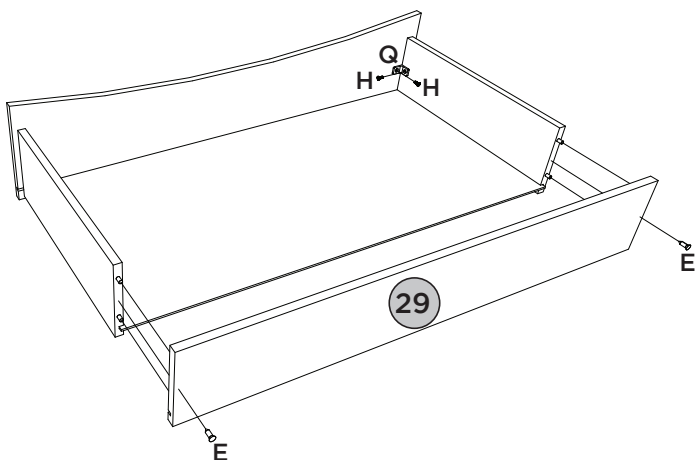
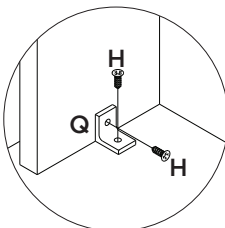
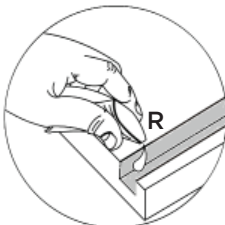
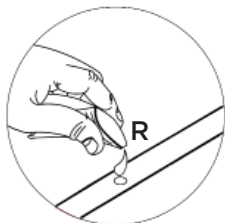

6x

4º

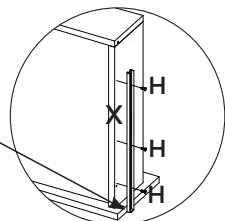
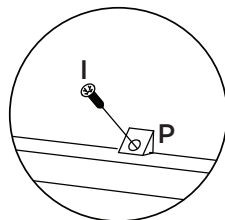
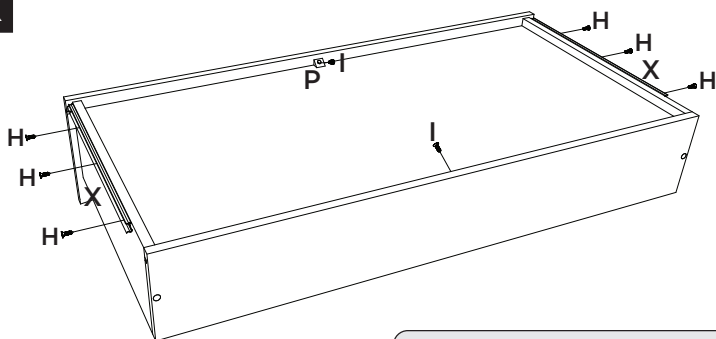



Deixar 3mm de distância da frente de gaveta.

Deje una separación de 3mm frente del cajón.

Leave 3mm away from the front of the drawer.

PASSO 20

ACESSÓRIOS REQUERIDOS

M	HENN	01
O		03
AG		03
AH		54

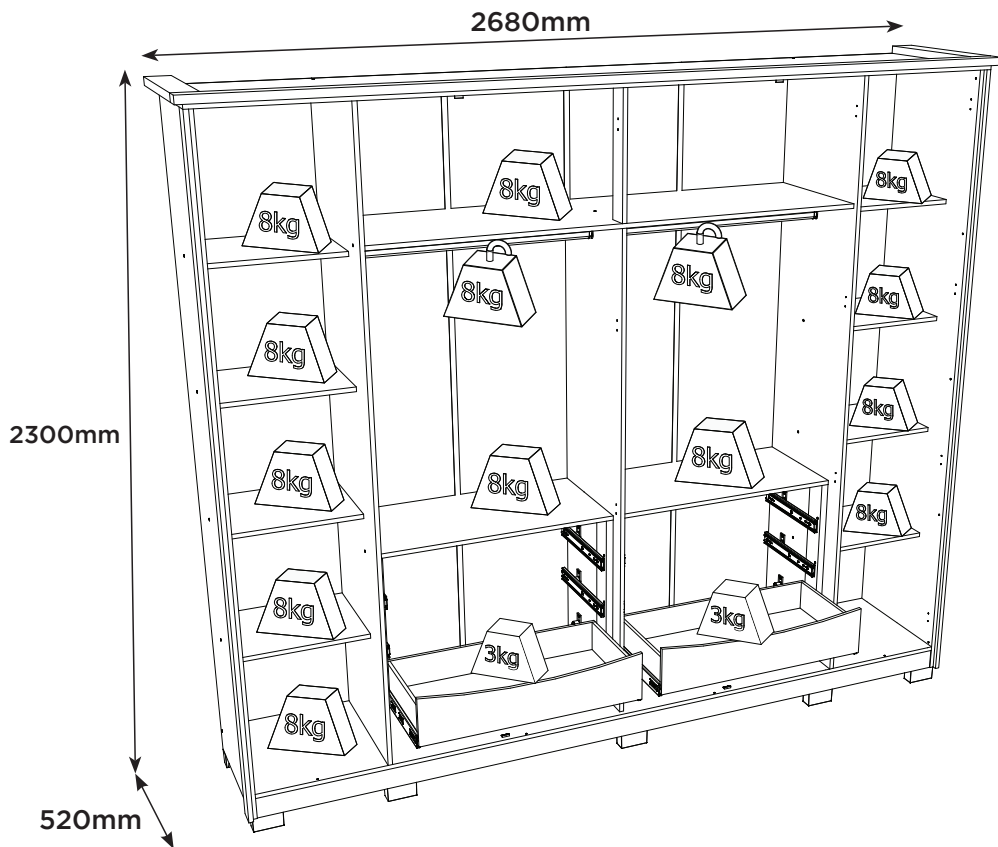

PERFECT CORRECTION
CORRECCIÓN PERFECTA

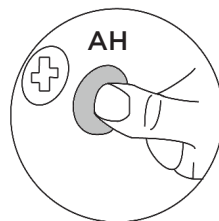
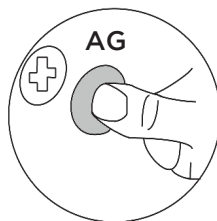
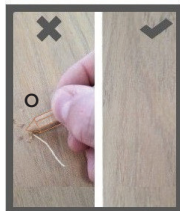

Pesos máximos recomendados com carga distribuída
Peso máximo recomendado con la carga distribuida
Recommended maximum weight with distributed load.

Produto Concluído
Producto terminado
Finished Product

