

CO7204 - AÉREO 0,60 M

Manual de Montagem
 Assembly Instructions
 Instrucción de Montaje

decibal®

Produto Montado
 Producto final
 Assembled

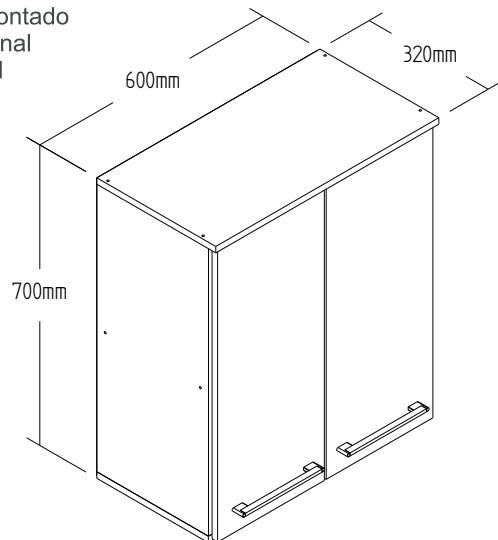

Verificar o lado desejado antes de efetuar a montagem
 Check the desired side before mounting
 Compruebe el lado deseado antes de montar

01°

C2
 12 UNI

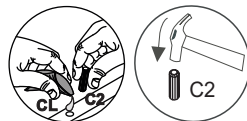
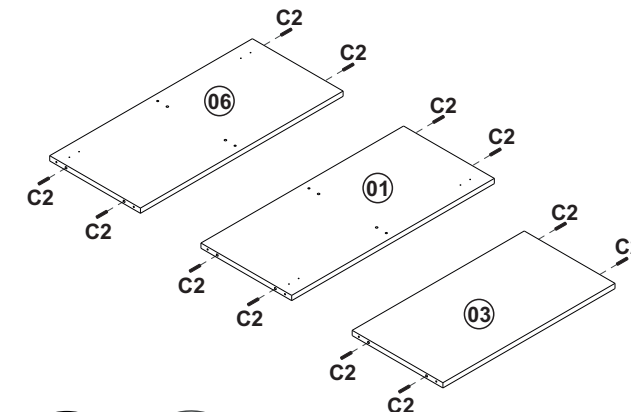

02°

P7
 4 UNI

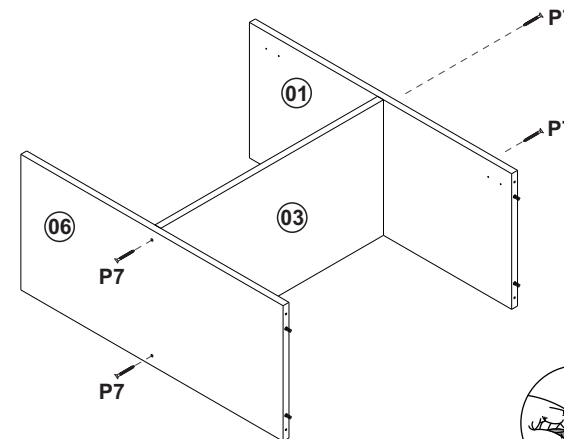

03°

P7
 8 UNI

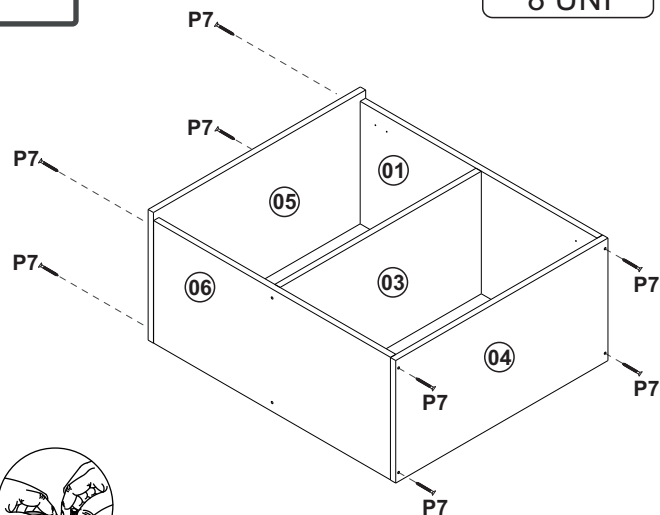

04°

COSTA/REVÉS/BACK

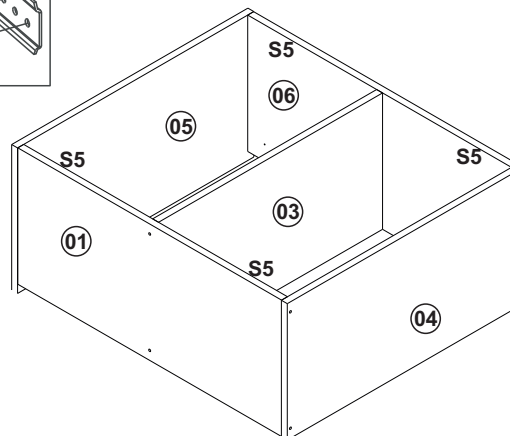
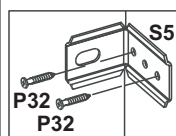

05°

COSTA/REVÉS/BACK

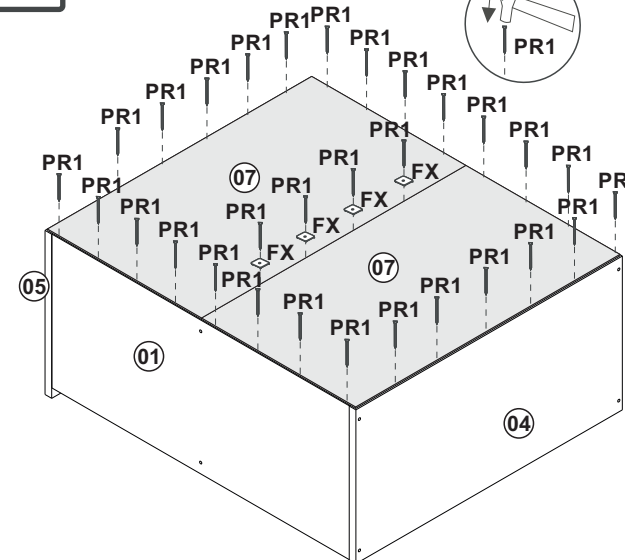

CO7204 - AÉREO 0,60 M

Manual de Montagem
Assembly Instructions
Instrucción de Montaje

decibal[®]
móveis

6°



**PESO SUPORTADO.
PESO SOPORTADO.
WEIGHT SUPPORTED.**

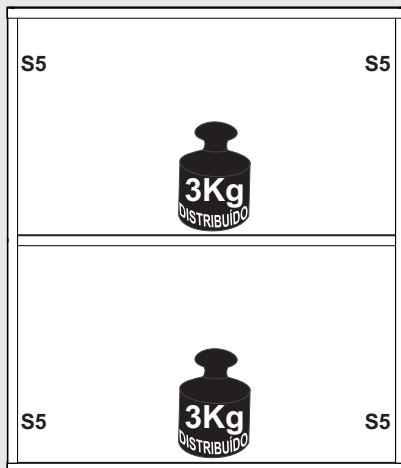
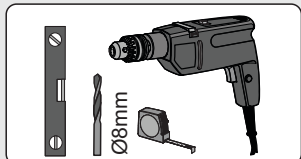

Fixação parede
Fixed in the wall

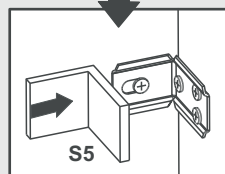
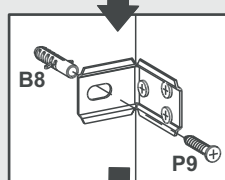
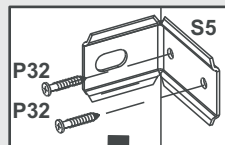

7°

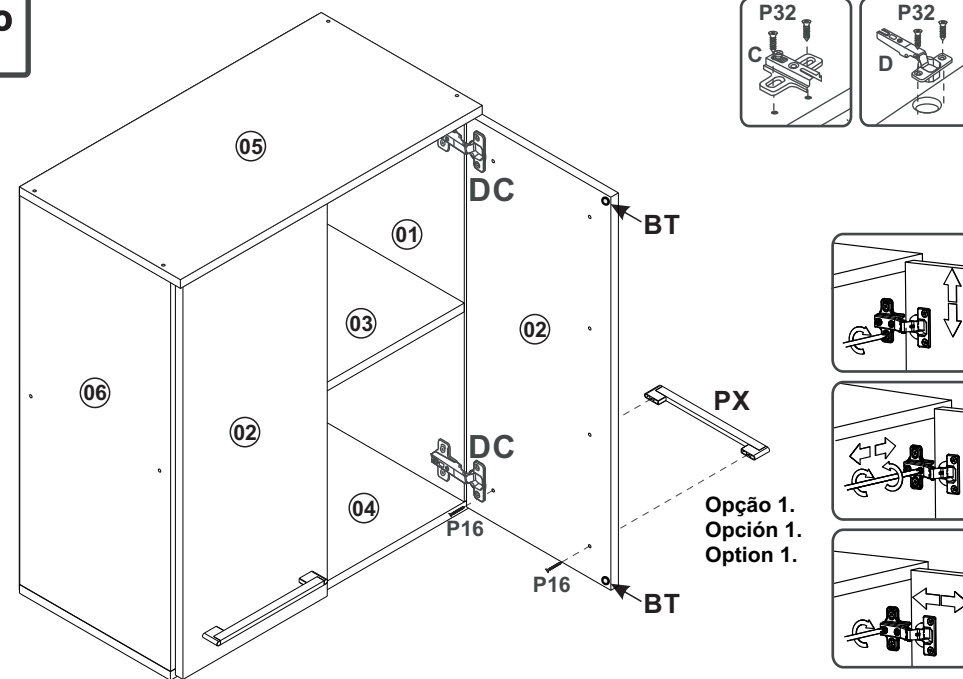

Relação de Peças/ Relación de Piezas/Parts List

N°	CÓDIGO/CODE	DESCRIÇÃO/DESCRIPCIÓN/DESCRIPTION	QTD/CANT	VOL.
1	0569357	LATERAL DIR/LATERAL/SIDE	670X300X15MM	1
2	0569359	PORTA/PUERTA/DOOR	677X287X15MM	2
3	0569360	PRATELEIRA/ESTANTE/SHELF	569X300X15MM	1
4	0569361	BASE	600X300X15MM	1
5	0569356	TAMPO/TAPA/TOP	600X320X15MM	1
6	0569358	LATERAL ESQ/ESTANTE/SHELF	670X300X15MM	1
7	0569362	COSTA/REVÉS/BACK	595X347X2, 8MM	2

ATENÇÃO!!!! montadores e consumidores

* Ajustar o torque da parafusadeira para não danificar as peças escareando o parafuso *

ATENCIÓN!!!! montadores e consumidores

* Ajuste el torque del destornillador para no dañar las piezas avallanando el tornillo *

ATTENTION!!!! assemblers and consumers

* Adjust the torque of the screwdriver so as not to damage the parts by countersinking the screw *



Atenção! verificar a posição adequada do puxador antes de efetuar a montagem.
¡Atención! Compruebe la posición adecuada del mango antes del montaje.
Attention! Check the proper position of the handle before assembling.



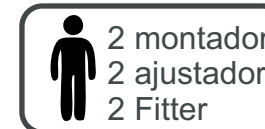
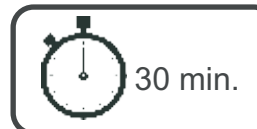













www.decibal.com.br



CO7204 - AÉREO 0,60 M

Manual de Montagem
Assembly Instructions
Instrucción de Montaje

decibal[®]
móveis

Escala (1:1)		Ferragens/ Herrajes/ Hardware		Escala (N/A)			
LEGENDA	DESCRIÇÃO/DESCRIPCIÓN/DESCRIPTION	CÓDIGO	QUANT.	LEGENDA	DESCRIÇÃO/DESCRIPCIÓN/DESCRIPTION	CÓDIGO	QUANT.
P7	 PARAFUSO/TORNILLO/SCREW 4X45	01318	12	CL	 COLA/PEGAMENTO/GLUE	01213	01
P9	 PARAFUSO/TORNILLO/SCREW 6X50	03827	04	ET	 ETIQUETA LOGO DECIBAL/LABEL DECIBAL	01312	01
P16	 PARAFUSO/TORNILLO/SCREW 3,5X25	09955	04	B8	 BUCHA/BUJE/BUCHING (8mm)	01311	04
P32	 PARAFUSO/TORNILLO/SCREW 4X14	12412	32	S5	 SUPORTE AÉREO/APOYO AÉREO/AIR SUPPORT	03828	04
C2	 CAVILHA/TARUGO/DOWEL 6X30 MM	01211	14	FX	 FIXADOR COSTA/FIJADOR FONDO/FIXER COAST	01331	05
PU	 PARAFUSO UNIÃO/UNIÓN DETORNILLO /SCREW UNION	01495	02	AD	 ADESIVO/ADHESIVO/ADHESIVE	15mm	08
PR1	 PREGO/CLAVO/NAIL 10X10	01330	40	BT	 BATENTE/BATIENTE DE SILICONA/SILICONE STOP 8MM	02921	04
				DC	 DOBRADIÇA/BISAGRA/HINGE D=35mm C= Alta	12615 (Amortecimento)	04
				PX	 PUXADOR/PEGADOR /HANDLE SEVILHA NEW GOLD 192 MM	13106	02

ATENÇÃO!!!! montadores e consumidores

* Para limpar o móveis utilize somente um pano úmido (umedecido em água pura ou água com sabão neutro). Depois, passe um pano seco. Evite a umidade excessiva.
* Evite usar álcool, água sanitária, detergente e outros produtos químicos, mesmo diluídos em água. Não utilize produtos abrasivos de nenhuma espécie

ATENCIÓN!!!! montadores e consumidores

* Para limpiar el mueble utilice solamente un paño húmedo (humedecido con agua limpia o con un jabón suave). A continuación, utilice un paño seco. Evite el exceso de humedad.
* Evite uso de alcohol, hipocloritro solución basada, detergente y otros productos químicos, mismo diluídos en agua.
* No utilice productos abrasivos de ningún tipo.

ATTENTION!!!! assemblers and consumers

*To clean the furniture, use only a damp cloth (humidify it only in pure water or water and neutral soap).After, use a dry cloth.Avoid excessive humidity.
*Avoid using alcohol, bleach, detergent and other chemical products, even diluted in water. Do not use any kind of abrasive cleaning agents to clean the furniture.
The use of such products may jeopardize the ?nal characteristics of the furniture.

Ferramentas necessárias
Necessary tools
Herramientas necesarias

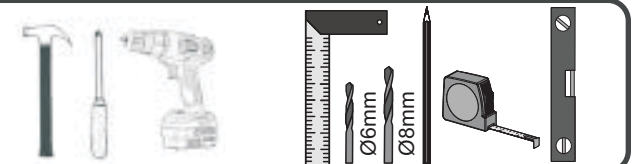

Medida em mm

