

Guarda Roupa City Of Lights Gr3020

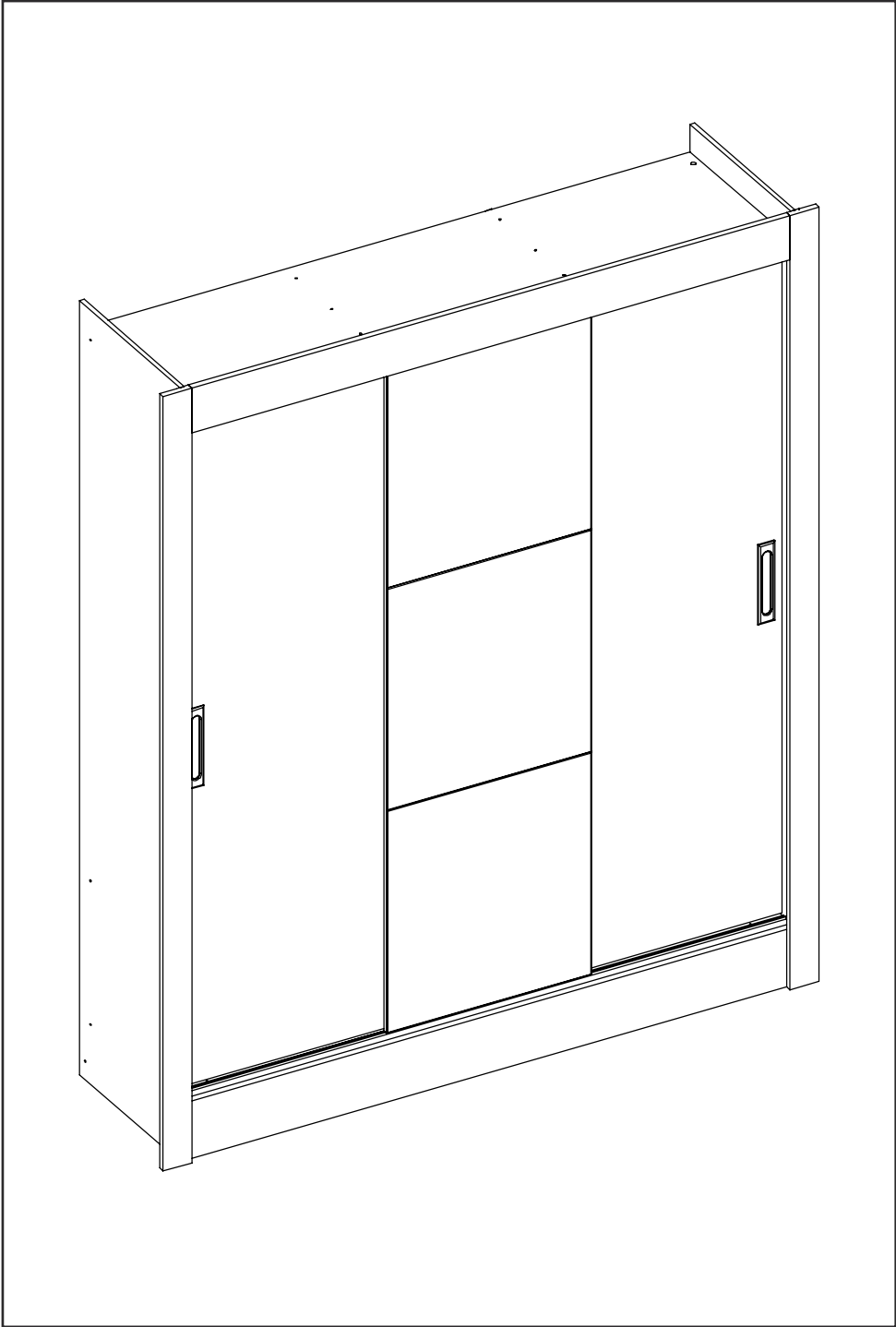

Como trocar seu produto

Se seu produto chegou com algum defeito você tem 7 dias para solicitar a troca. Você vai precisar:

- 1 Ter em mãos as fotos das peças com defeito; descrição; código (como está aqui no manual) e quantidade de peças com defeito.
- 2 Acesse o chat em nosso site.
- 3 Selecione o seu pedido, e depois a opção “Quero trocar um produto”.
- 4 Pronto, agora é só preencher as informações e enviar. Entraremos em contato por e-mail para te dar todas as instruções.

Dicas para prolongar a vida útil do móvel

- 1 Retire o pó com uma flanela seca, depois use um pano macio, levemente umedecido com água. Pode utilizar detergente neutro ou sabão neutro.
- 2 Reaperte os parafusos de tempos em tempos para garantir a estabilidade e durabilidade.
- 3 O acabamento do seu produto pode ser danificado pela falta de ventilação e excesso de calor

Qualquer dúvida sobre os nossos produtos você pode entrar em contato pelo nosso canal de atendimento: <https://www.madeiramadeira.com.br/central-de-ajuda>

Para mais dicas amigas e inspirações de decoração acesse o Blog: <https://www.madeiramadeira.com.br/central-de-dicas>

Siga MadeiraMadeira:





















Para a montagem do produto você vai precisar de:

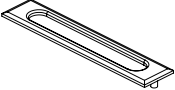



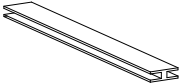
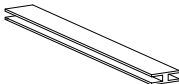

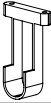
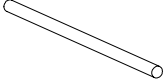

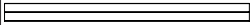

- Confira as peças, componentes e se possui as ferramentas necessárias para a montagem
- Para proteger seu móvel, coloque as peças sobre um tapete.
- Para realizar a montagem, é necessário 2 pessoas.
Convide sua família e amigos para montar com você.

LISTA DE FERRAGENS

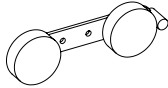
REF.	COD.	DESCRIÇÃO		QTD.
A	12757	Parafuso Ø3,5x40 Phillips c/flageada		18
B	8659	Parafuso Ø3,5x40 Phillips c/chata		4
C	5738	Parafuso Ø3,5x12 Phillips c/chata		61
D	3874	Porca plástica 12x9		22
E	3881	Cavilha Ø6,0x30		10
F	8686	Cavilha Ø6,0x50		01
G	3875	Prego 10x10 c/c		60
H	8740	Suporte prateleira branco		8

I	10421	Suporte cabideiro branco		02
J	3877	Garra p/ costas		10
K	8455	Puxador		03
L	3882	Cantoneira Metálica		12
M	3872	Bisnaga de cola		01
N	23743	Cantoneira Plástica 20x20x42		09
O	23704	Perfil p/costas 1780 branco		01
P	16562	Perfil p/costas 375 branco		01
Q	11409	Cantoneira Dupla		03
R	23565	Suporte Cabideiro central		01
S	23703	Cabideiro 1037MM		01
T	7035	Parafuso Ø3,5x20 Phillips c/chata		02
U	15597	Sapata simples		04

V	3878	Sapata Dupla		02
W	30490	Trilho alumínio 1569		01
X	23706	Trilho Plástico 1569x60x24		01
Y	21709	Guia porta de correr inferior		09
Z	23319	Guia porta de correr superior		01
AA	12025	Parafuso Ø3,5x20 Phillips c/flageada		04
AB	7035	Parafuso Ø3,5x20 Phillips c/chata		01
AC	22812	Batente porta de correr		01
AD	5738	Parafuso Ø3,5x12 Phillips c/chata		06

LISTA DE PEÇAS

PEÇAS POR VOLUME

CAIXA LATERAL

Nº PEÇA	CÓD IND	DESCRIÇÃO	QTD	DIMENSÕES (mm)			KG
				COMP	LARG	ESP	
1	23707	Chapéu	1	1569	385	12	4,890
2	23713	Chapéu inferior	1	1569	450	12	5,710
3	23717	Chapéu superior	1	1569	450	12	5,710
4	23719	Divisão	1	1388	385	12	4,320
5	23720	Encabeçamento	1	1549	115	15	0,863
6	23722	Frontal	2	2005	75	15	0,846
7	23724	Lateral Dir	1	2005	450	12	6,920
8	23726	Lateral Esq	1	2005	450	12	6,920
9	24980	Pilastra	2	360	92	12	0,249
10	23732	Prateleira	2	515	360	12	4,07
11	23733	Rodapé frontal	1	1569	150	15	0,846
12	23735	Rodapé traseiro	1	1569	150	15	0,846
13	24981	travessa	1	401	150	15	0,200

CAIXA PORTAS							
Nº PEÇA	CÓD IND	DESCRIÇÃO	QTD	DIMENSÕES (mm)			KG
				COMP	LARG	ESP	
14	23718	Costas	3	1780	528	3	2,739
15	23730	Portas	3	1736	530	15	3,779

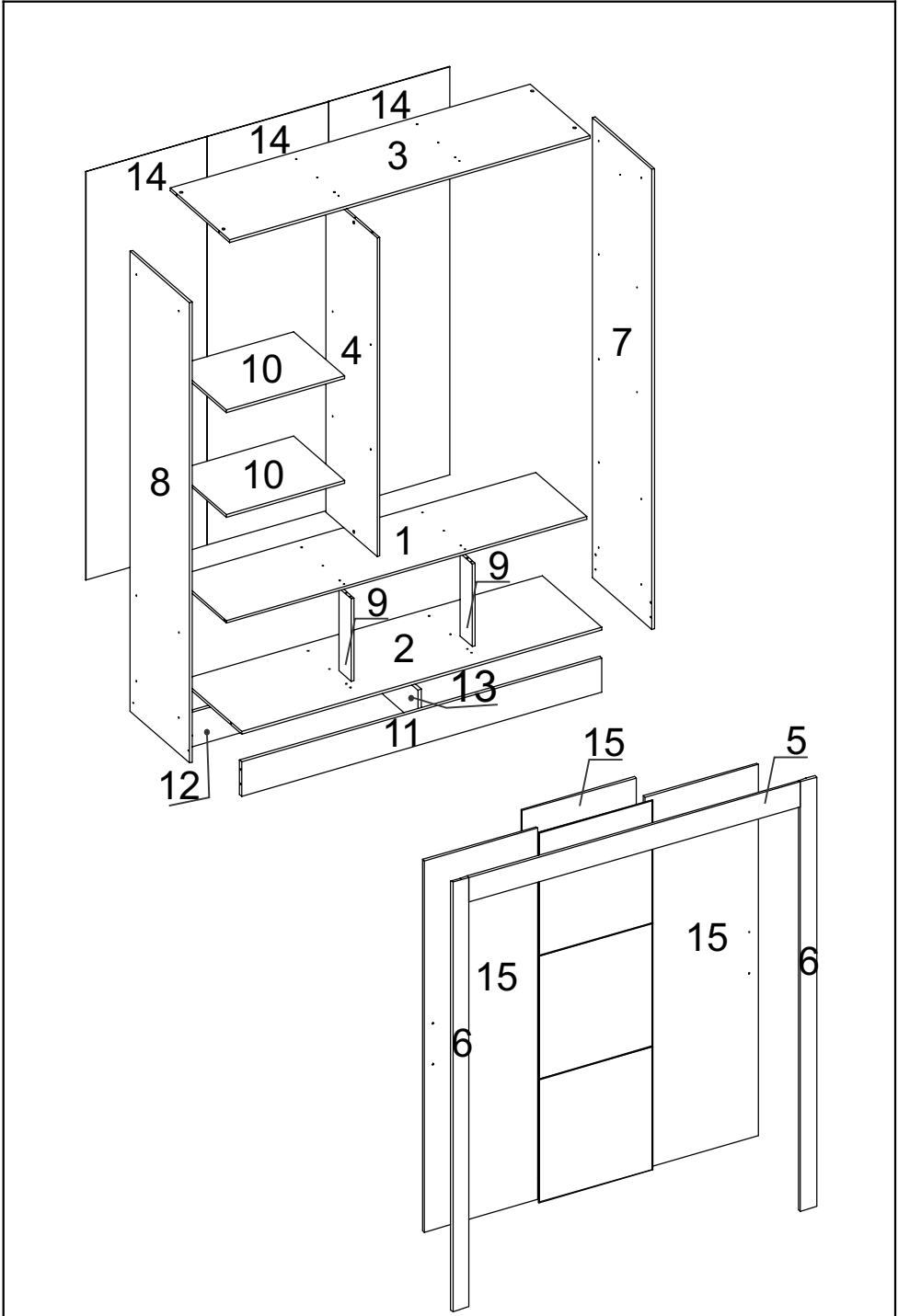

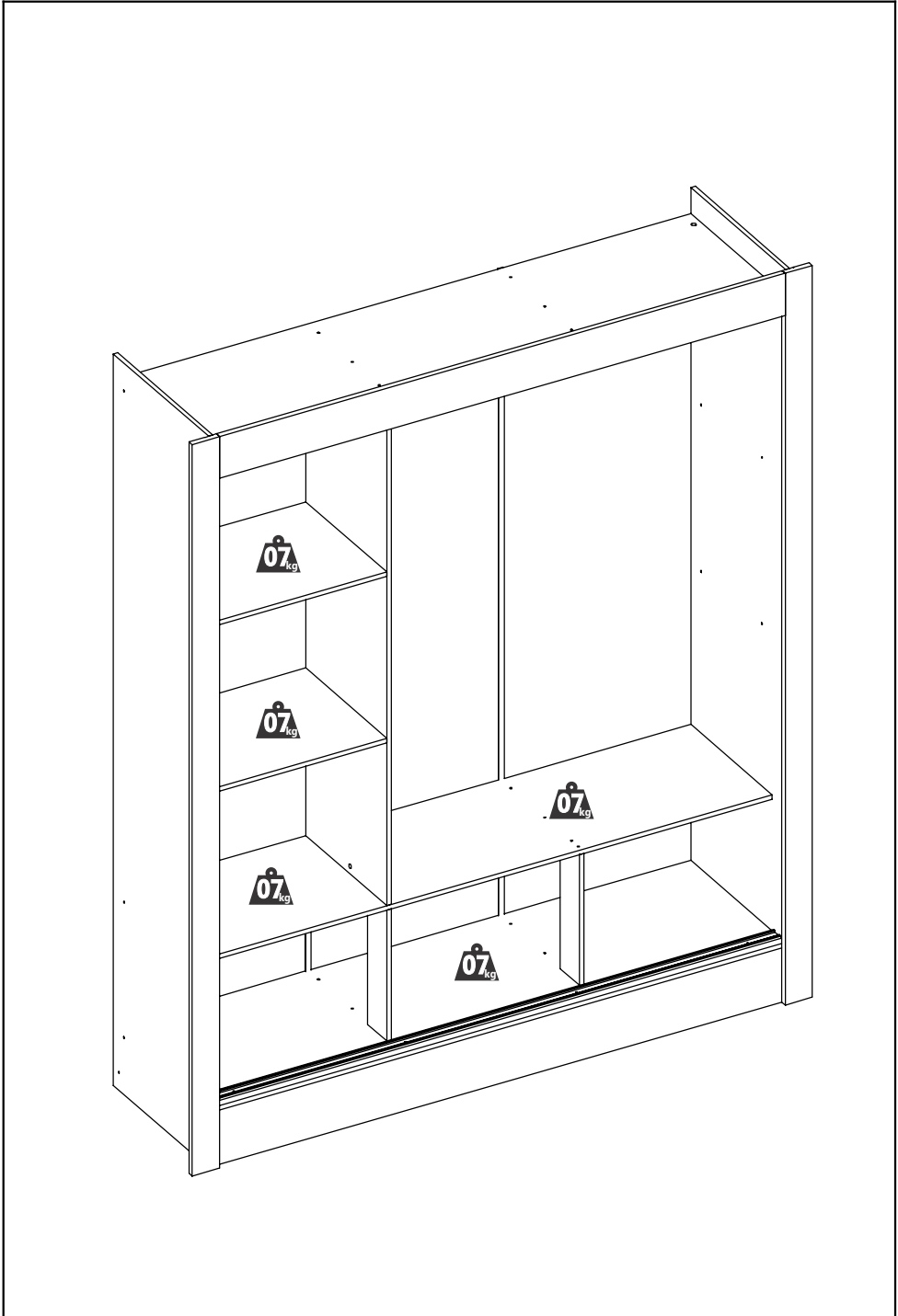

1

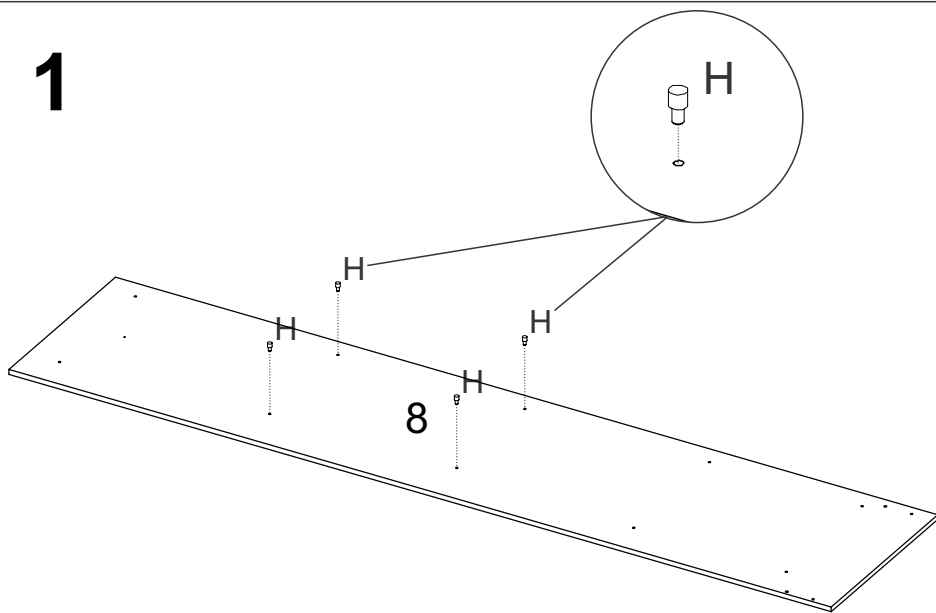

2

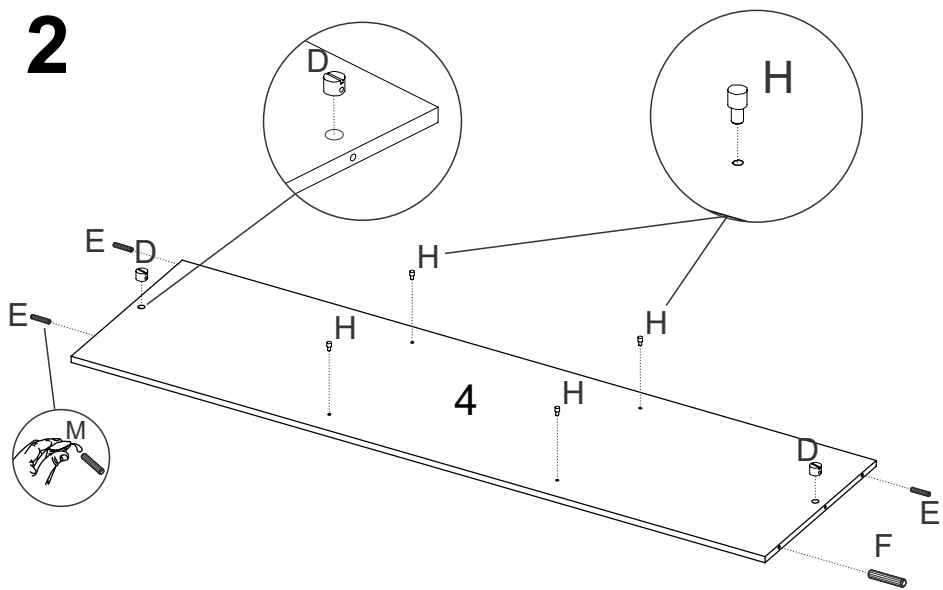

ATENÇÃO
Cavilha Maior
F

3

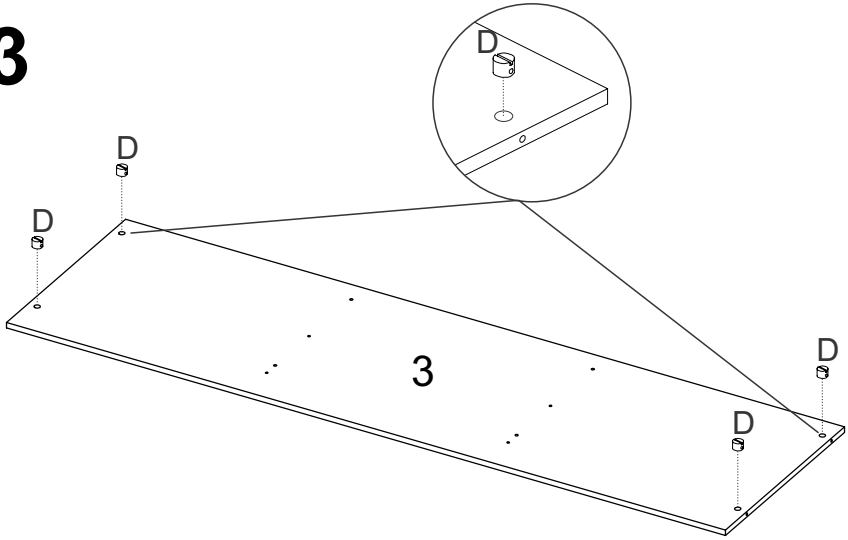

4

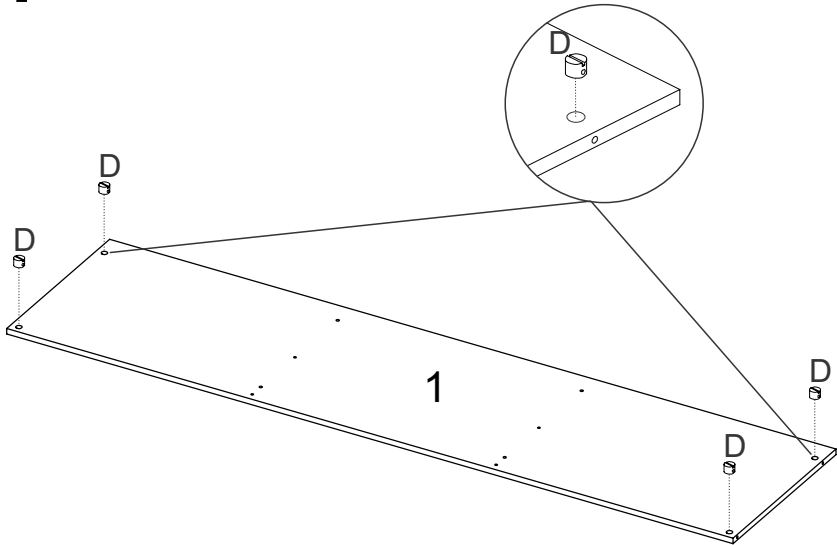

5

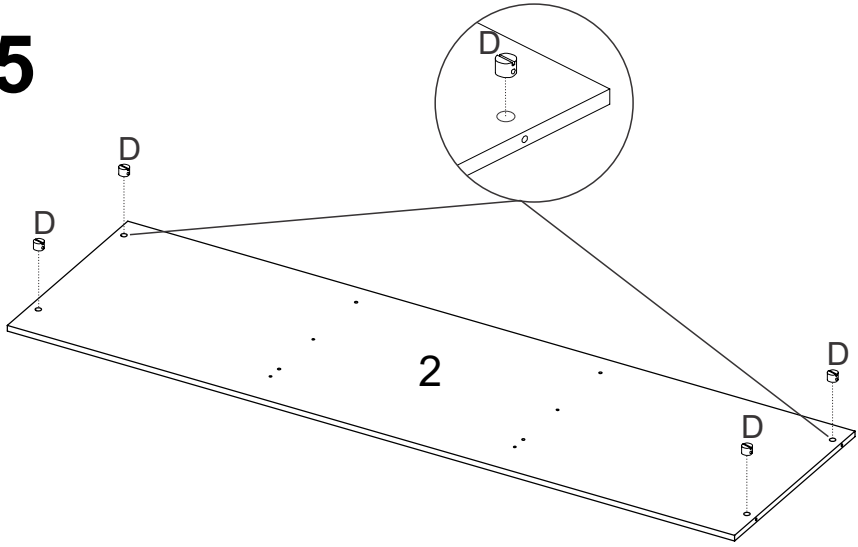

6

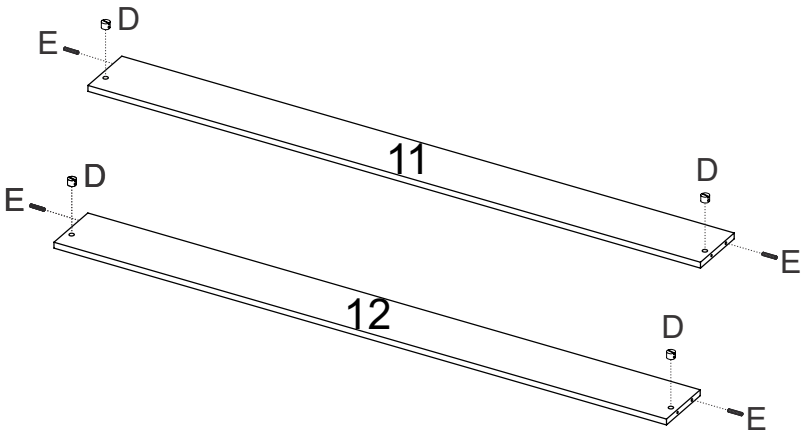

7

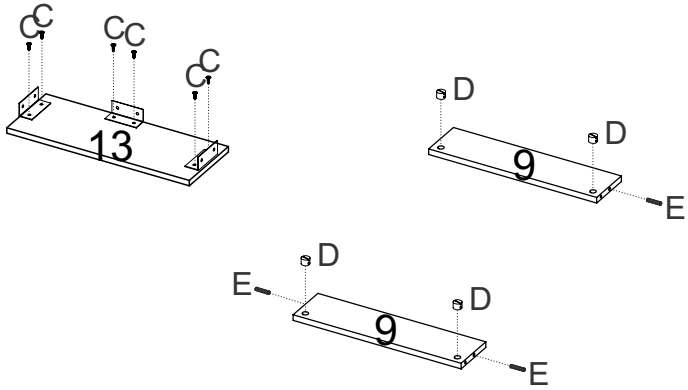

8

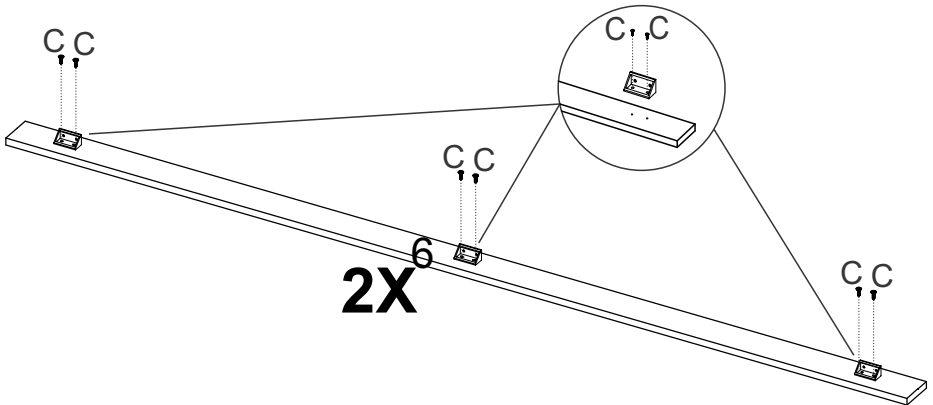

9

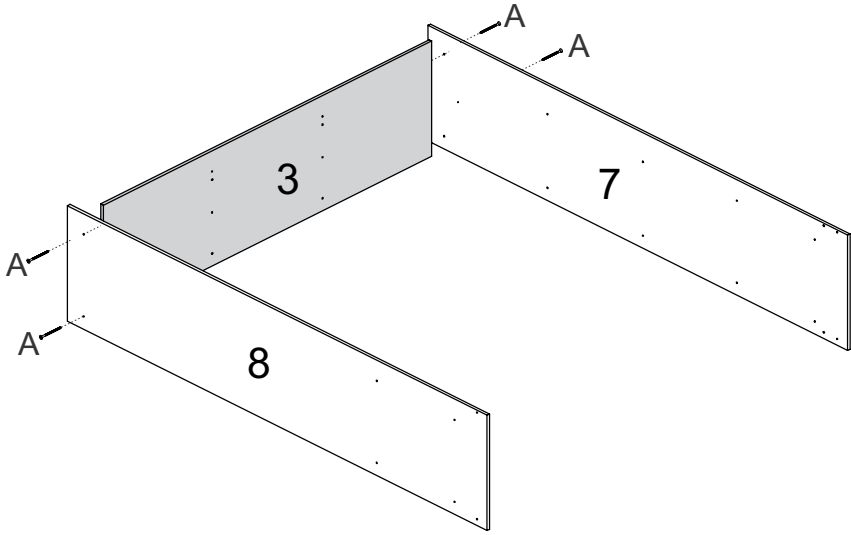

10

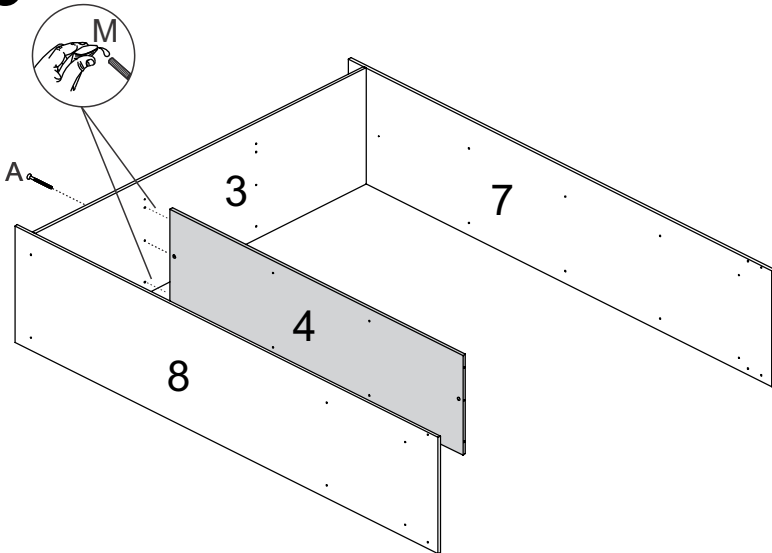

11

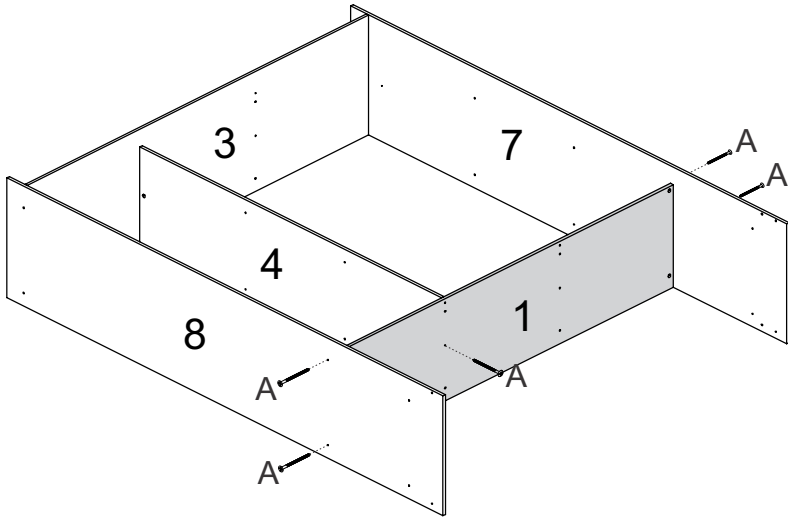

12

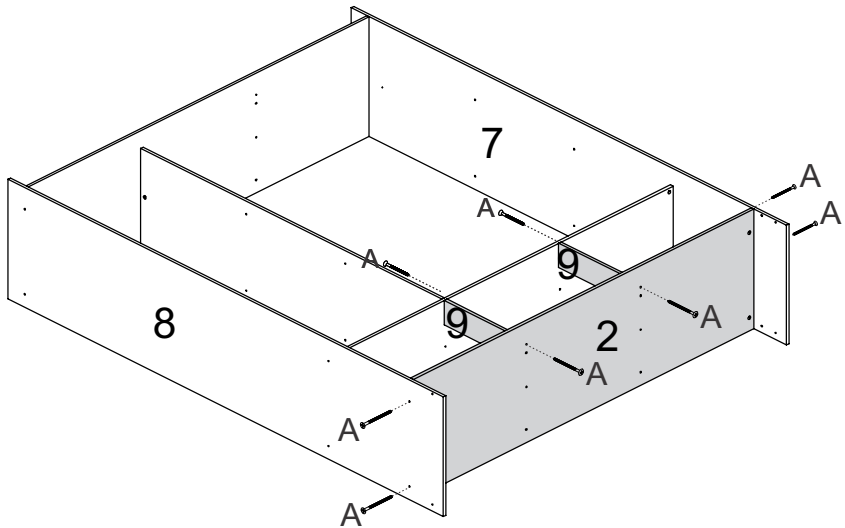

13

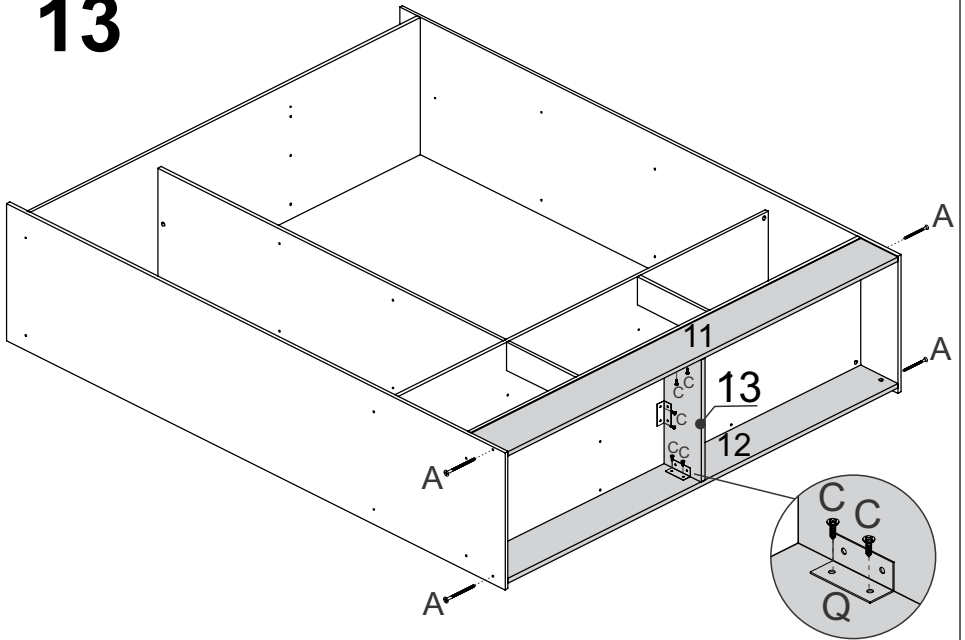

14

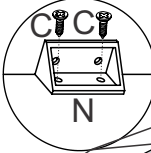

x3

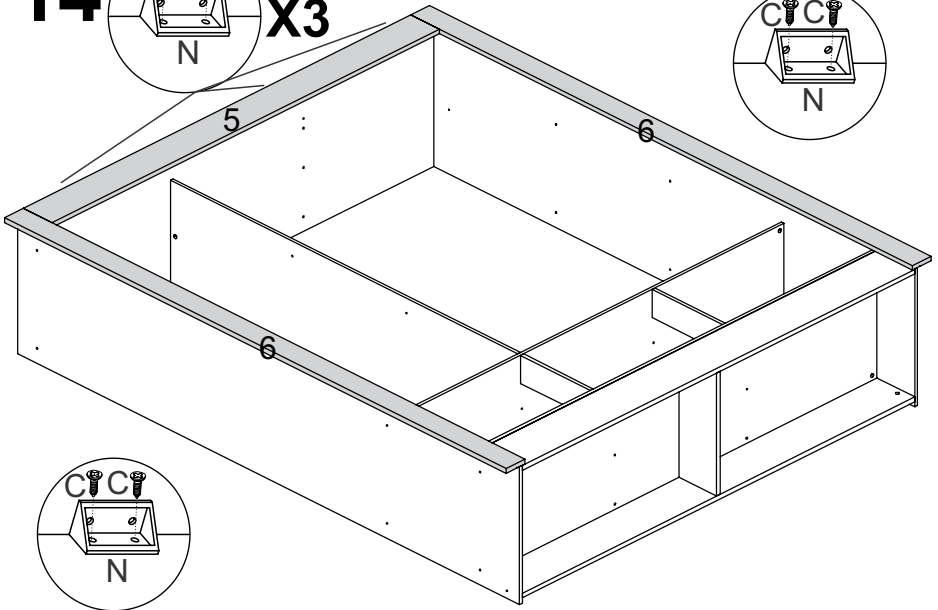
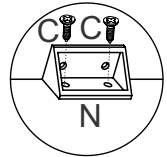

15

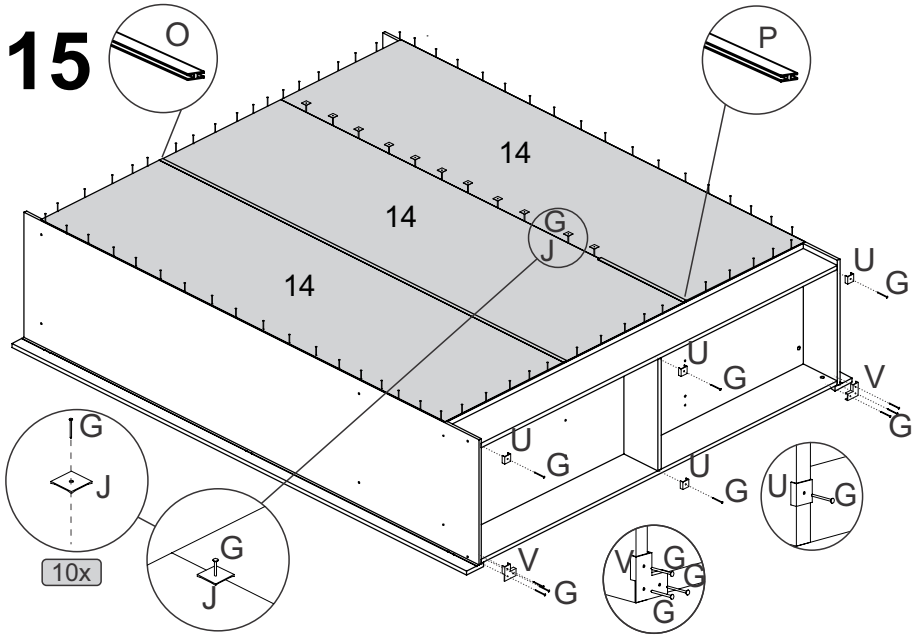

16

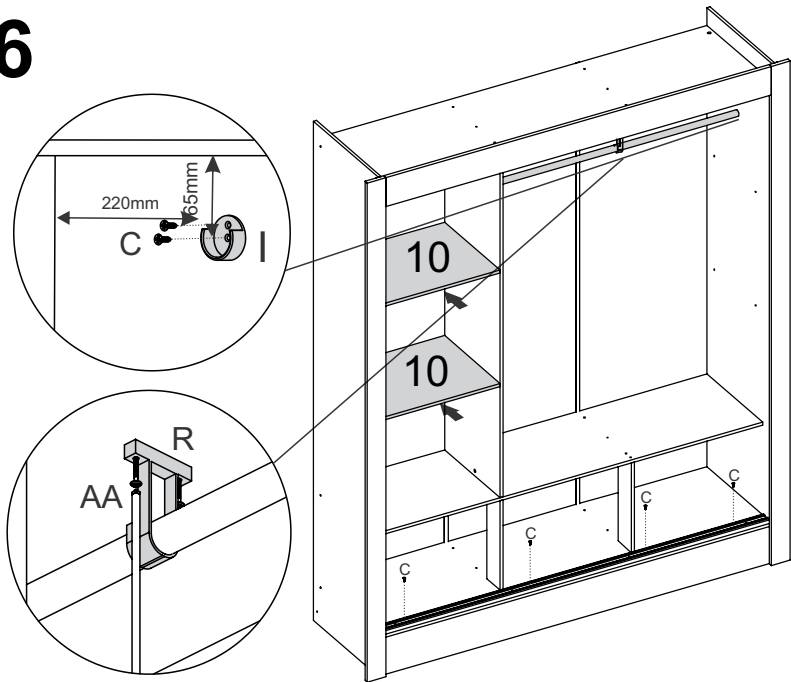

17

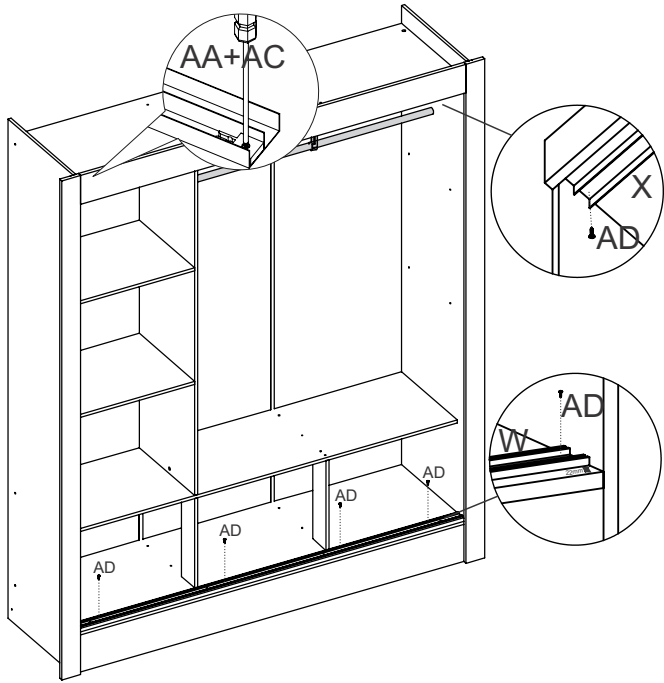

18

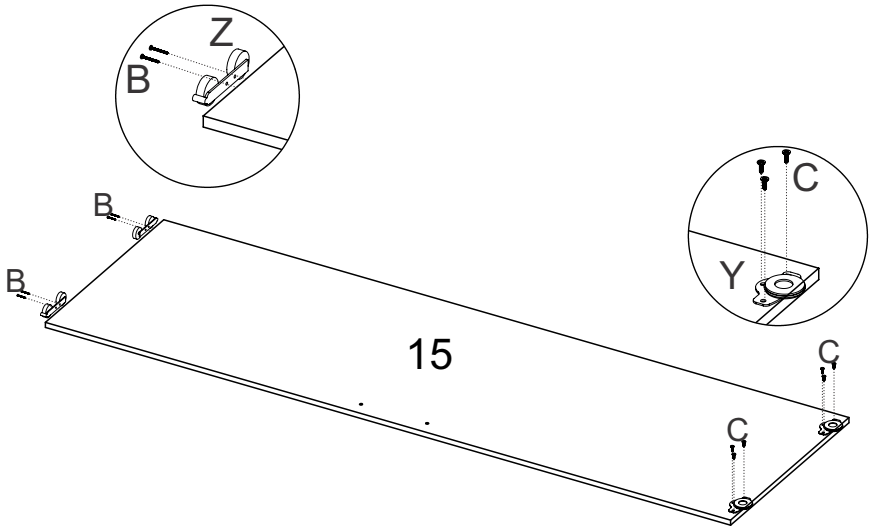

19

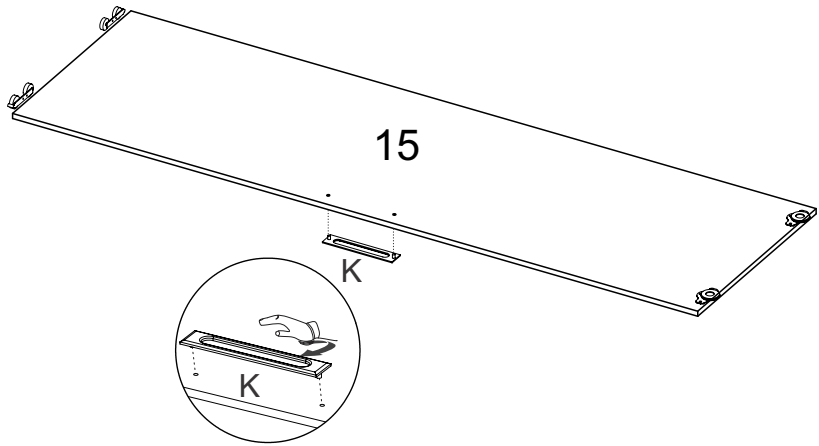

20

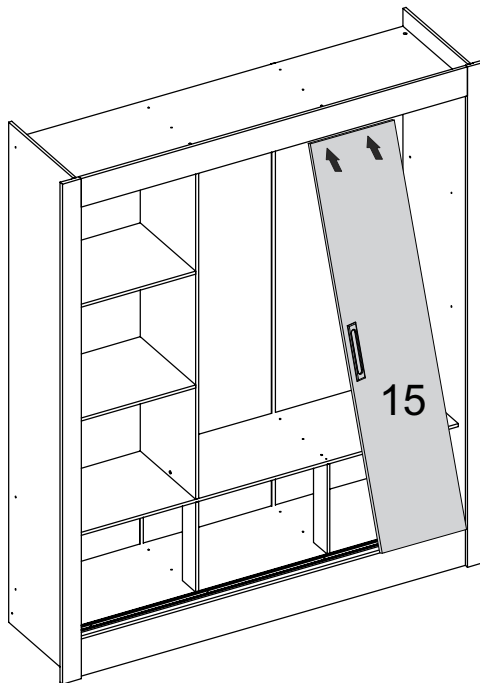

21

Montagem do espelho(se adquirido)

- Efetuar limpeza das peças com álcool isopropílico nas duas superfícies;
- Após a colagem considerar um tempo de espera (pre-secagem 40min) antes de usar o componente ou concluir a montagem destas peças.
- Recomenda-se a montagem no chão, em superfície estável e plana devendo aplicar pressão no espelho para a melhor fixação.
- Recomendamos que o espelho seja o primeiro passo de montagem e a colocação das portas o último, assim asseguramos um tempo de cura da colagem.



22

-Retirar a película de proteção da fita dupla-face do espelho e fixar na porta começando a partir da parte inferior conforme imagem abaixo;

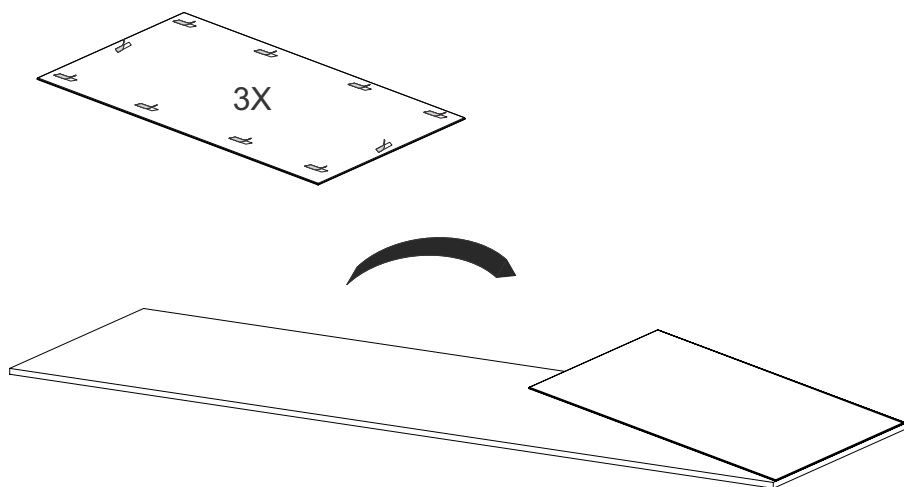

23

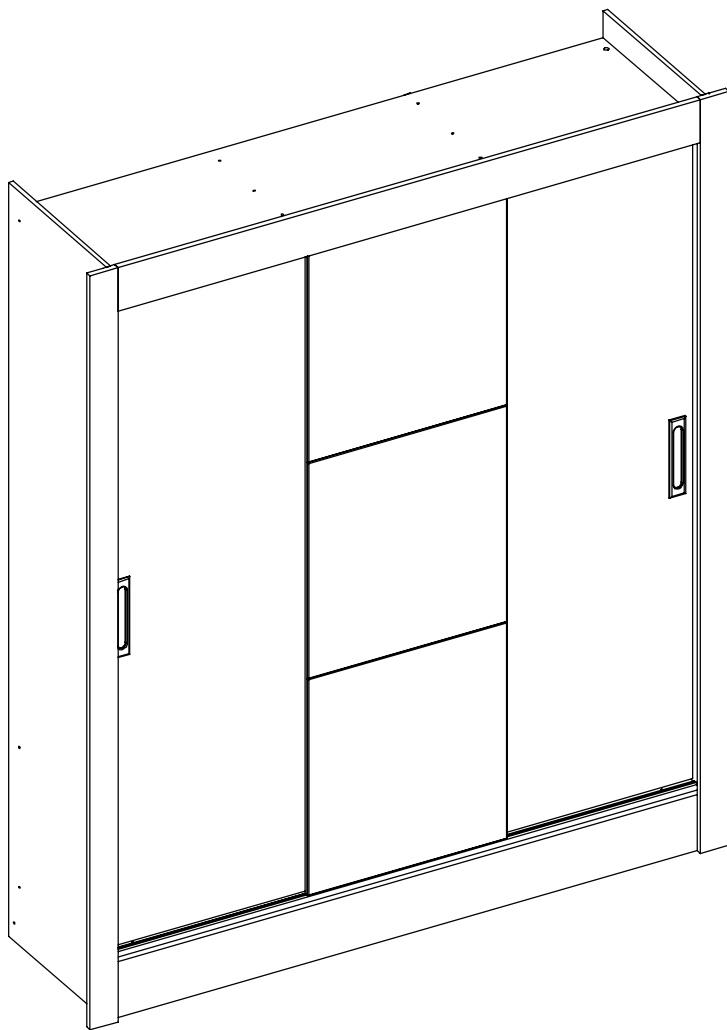

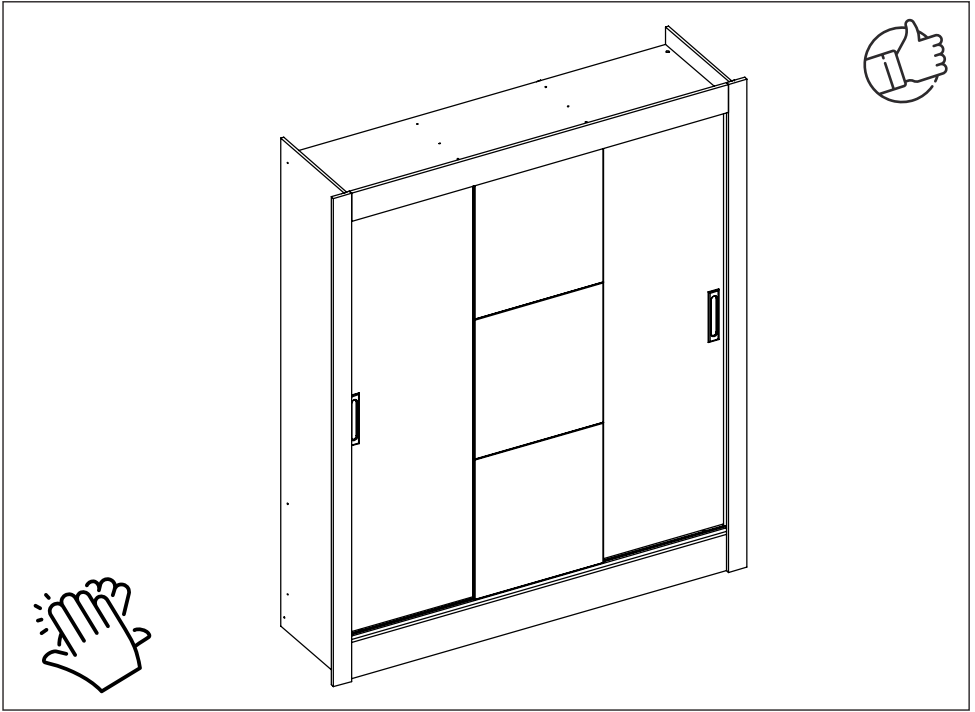

yes casa
madeiramadeira

V.01