

ORIENTAÇÕES GERAIS | General guidelines | Orientaciones generales

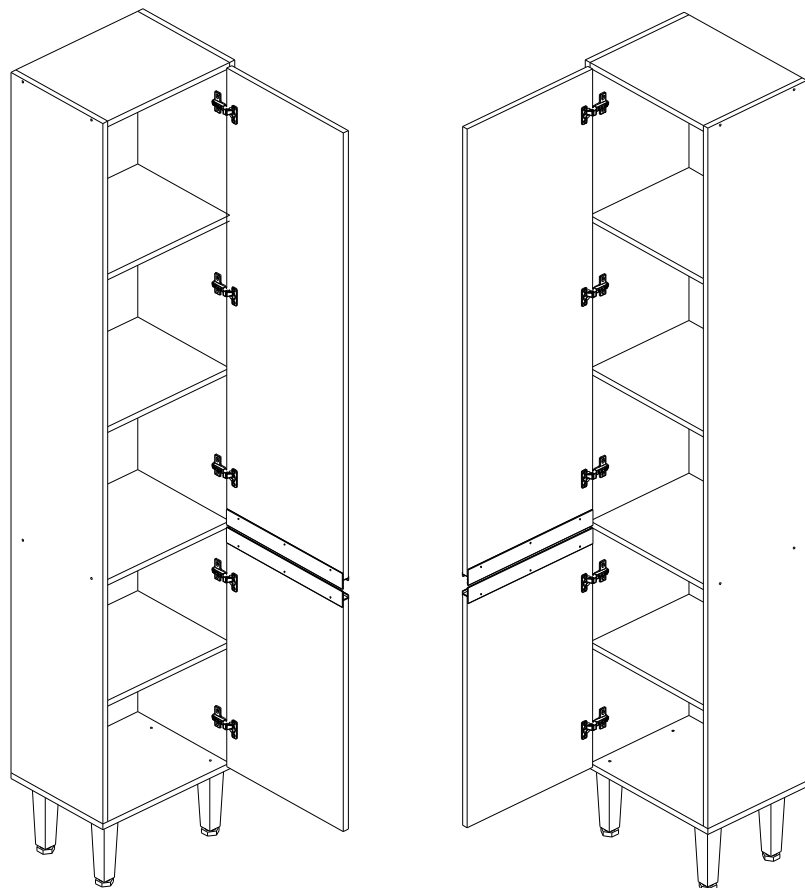

NOTA: As portas podem ser montadas para a direita ou esquerda.

NOTE: The doors can be assembly to right or left.

NOTA: Las puertas pueden ser armadas a derecha o izquierda.

- Separe e verifique todas as peças e ferragens antes de iniciar a montagem, isso facilitará a mesma.
- Separate and check all parts and hardware before starting assembly, this will facilitate it.
- Separe y verifique todas las piezas y herrajes antes de iniciar el armado, eso facilitará la misma.

- Utilize a caixa para proteger o piso durante a montagem.
- Use the box to protect the floor during assembly.
- Utilice la caja para proteger el suelo durante el armado.

- Para o bom funcionamento do produto é fundamental seguir as instruções desse manual.
- For the proper functioning of the product it is essential to follow the instructions in that manual.
- Para el buen funcionamiento del producto es fundamental seguir las instrucciones de dicho manual.

- A conservação e limpeza deve ser feita com pano levemente umedecido com água, não utilizar produtos abrasivos e não expor o produto ao calor excessivo.
- Preservation and cleaning should be done with cloth slightly moistened with water, do not use abrasives and do not expose the product to excessive heat.
- La conservación y la limpieza deben hacerse con un paño ligeramente humedecido con agua, no utilizar productos abrasivos y no exponer el producto al calor excesivo.

FERRAMENTAS NECESSÁRIAS | Necessary Tools | Herramientas necesarias



Chave Phillips  
Screwdriver Phillips  
Destornillador cruz



Martelo  
Hammer  
Martillo



Furadeira  
Drill machine  
Taladro



Broca 8mm  
Drill bit 5/16"  
Taladro 8mm

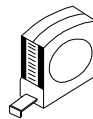







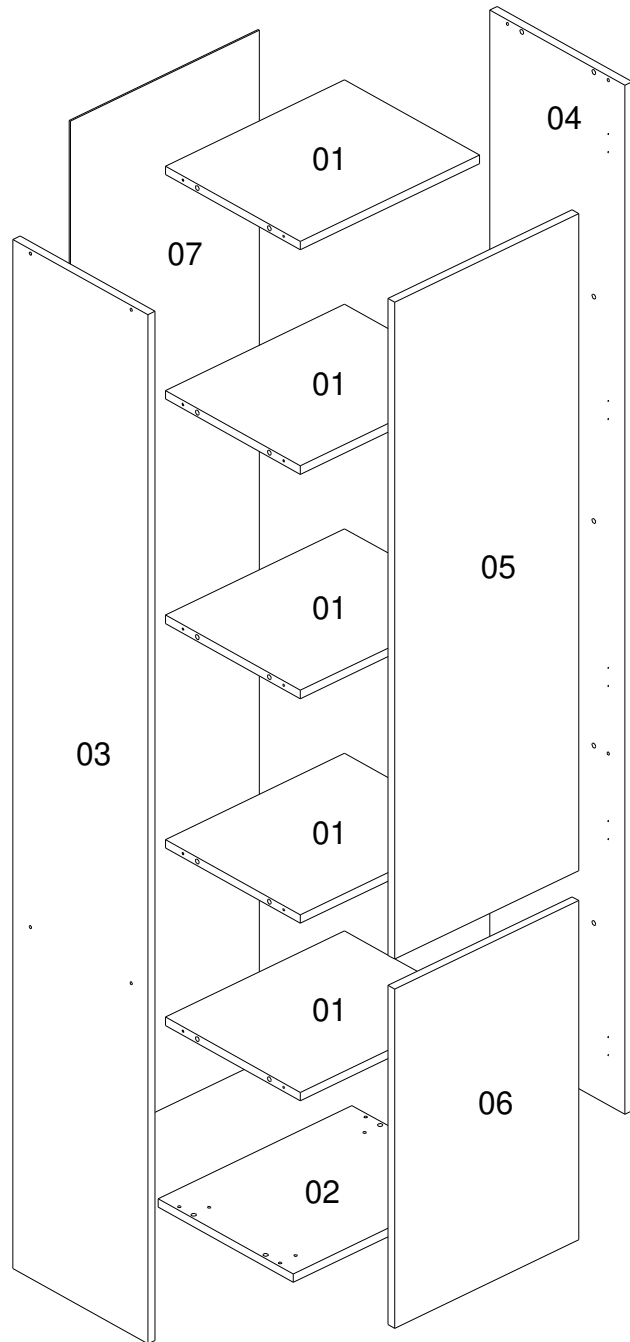



Trena  
Measuring tape  
Cinta de medición

- A Mademovel Brasil Indústria de Móveis Ltda oferece garantia contra defeitos de fabricação por 90 dias, contados a partir do recebimento do produto pelo consumidor.
- The Mademovel Brasil Indústria de Móveis Ltda offers warranty against manufacturing defects for 90 days, counted from the receipt of the product by the consumer.
- A Mademovel Brasil Indústria de Móveis Ltda ofrece garantía contra defectos de fabricación por 90 días, contados a partir de la recepción del producto por el consumidor.

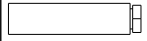
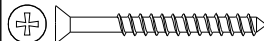
IDENTIFICAÇÃO DAS PEÇAS | Parts identification | Identificación de las piezas

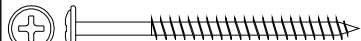
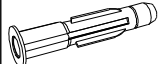
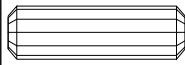

IDENTIFICAÇÃO DOS ACESSÓRIOS | Accessories identification | Identificación de accesorios

A3		Cantoneira de metal Metalic angle plates Suporte de metal	-	2
A5		Tapa furo adesivo Bore patch adhesive Tapones adhesivo	15mm	8
A7		Capa Cover Cubierta	-	2
B		Dobradiça curva Metal hinge curve Esquina de bisagra metálica	26mm	5
C		Prego Nail Clavo	10X10	44
C2		Pé Foot Pie	-	4
D5		Parafuso chato Flat head screw Tornillo plano	4x45mm	12
G		Calço dobradiça Hinge shim Bisagra de calce	-	5
J		Parafuso flangeado Flanged head screw Tornillo de flangeado	5x60mm	2
M		Bucha Bushing Tapón	8mm	2
P		Cavilha Wooden dowel Taquete	8X30mm	24
Q		Parafuso chato Flat head screw Tornillo plano	3,5x14mm	32
U		Parafuso panela Flanged head screw Tornillo de flangeado	4,5X45mm	4
X9		Puxador Handle Tirador	378mm	2

PRÉ-MONTAGEM | Pre-assemble | Pre armado

01

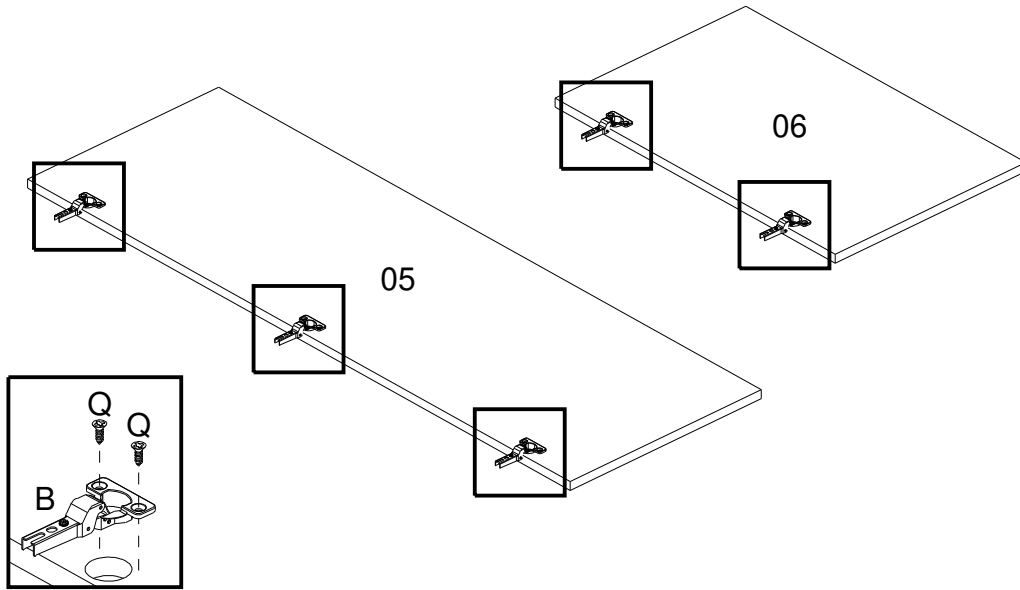

02

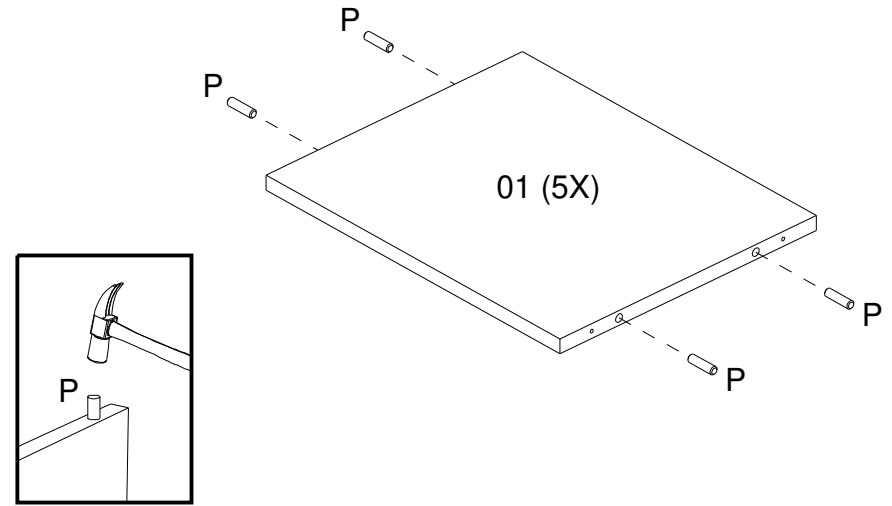

03

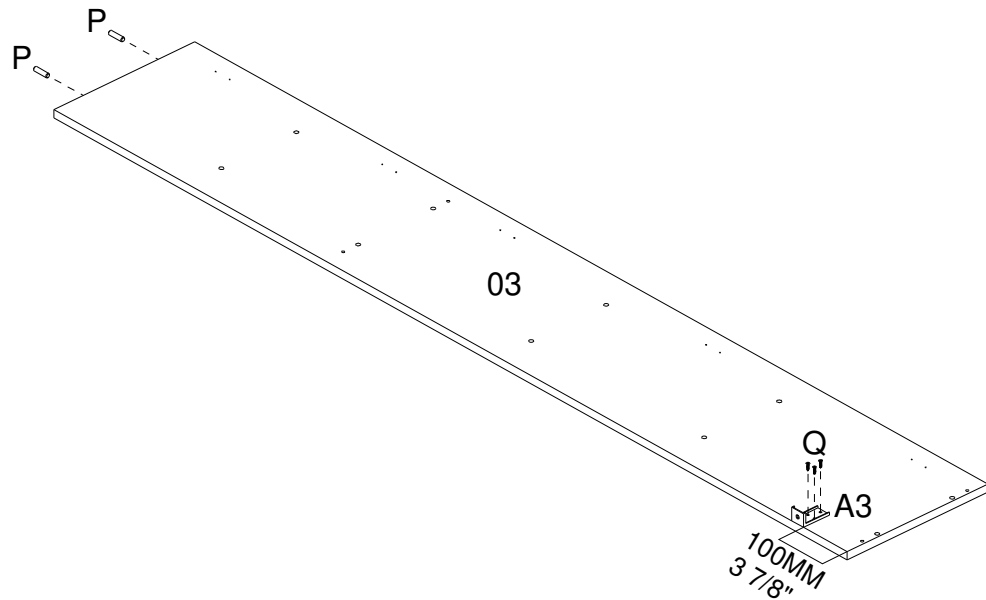

04

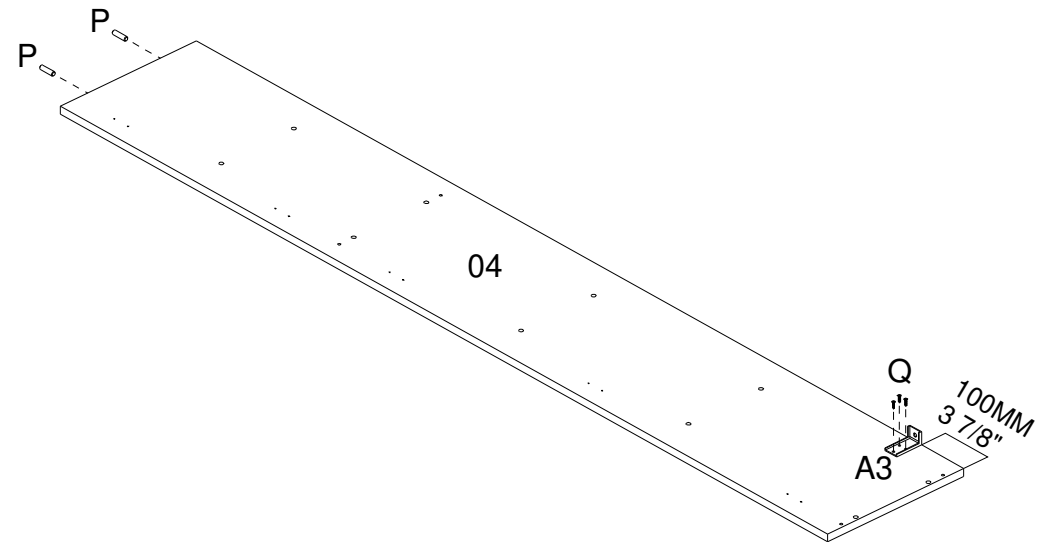

# MONTAGEM | Assembly | Armado

05

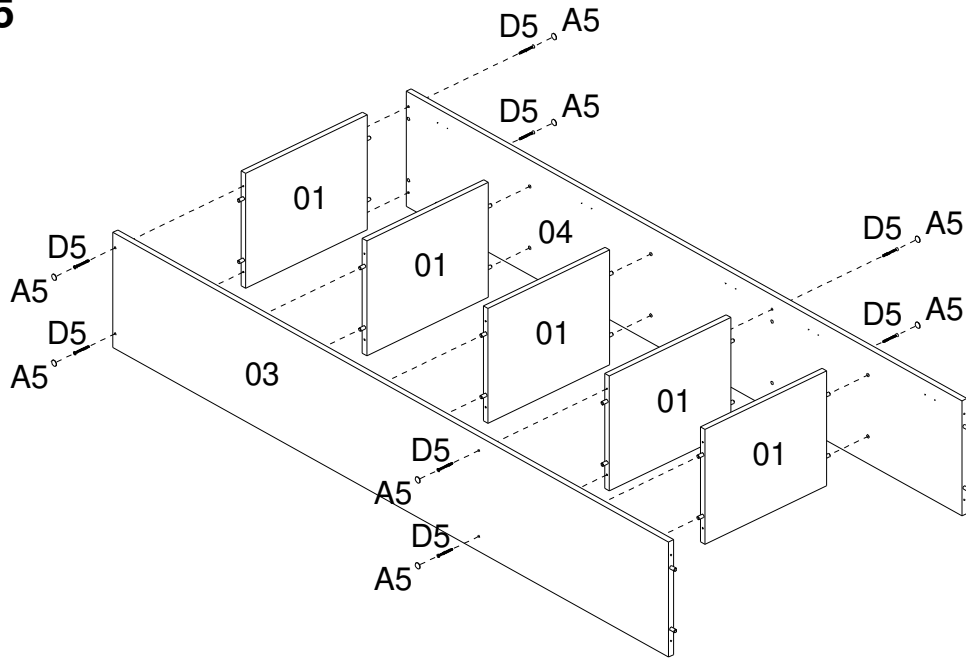

06

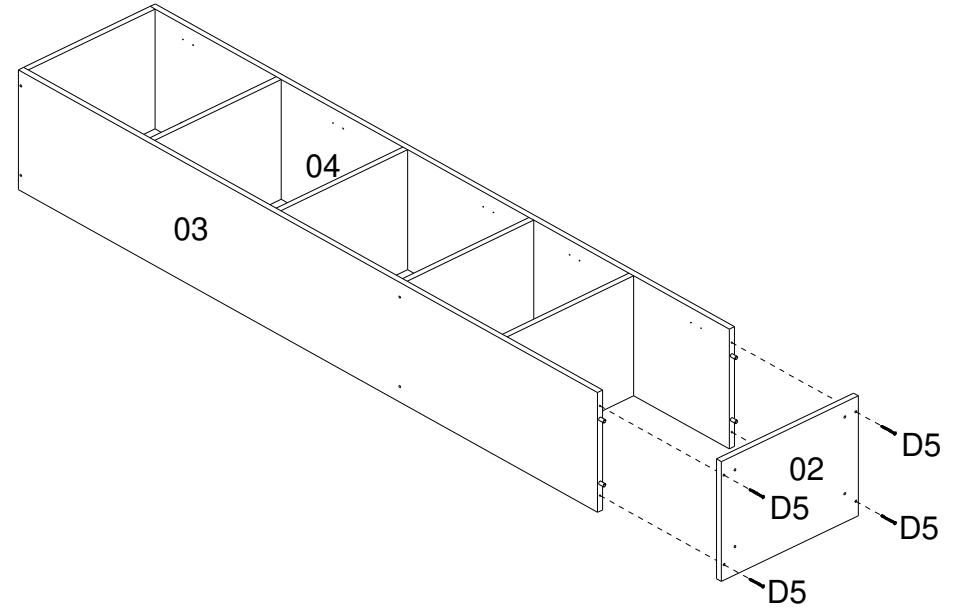

07

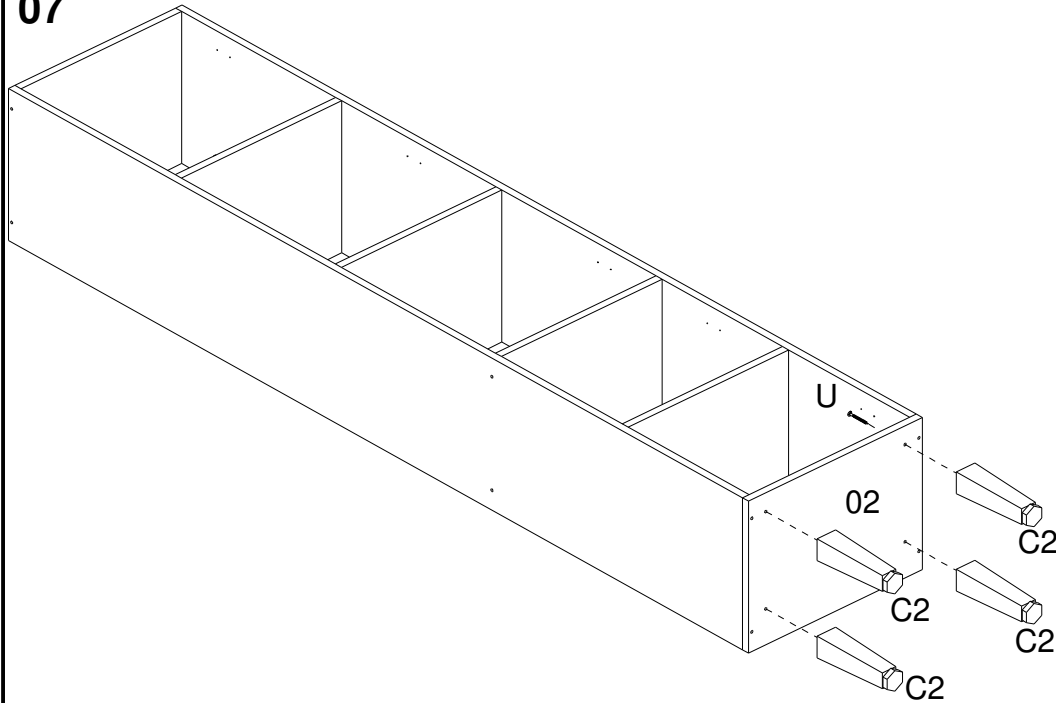

08

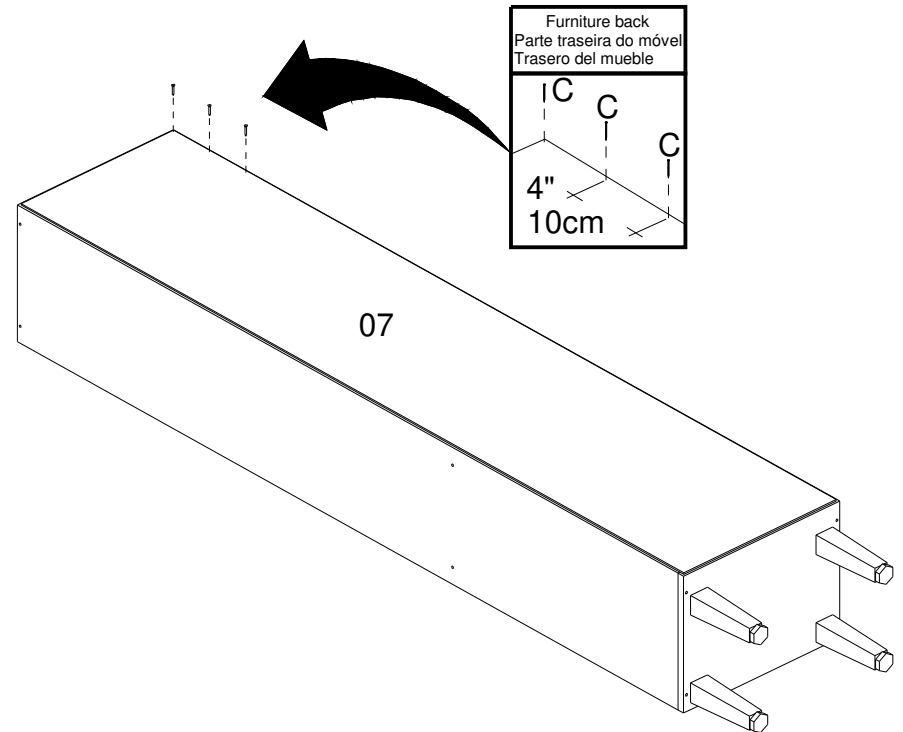

# PORTAS PARA DIREITA | Doors to the right | Puertas a la derecha

09

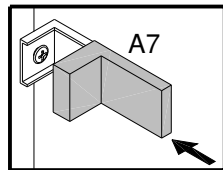
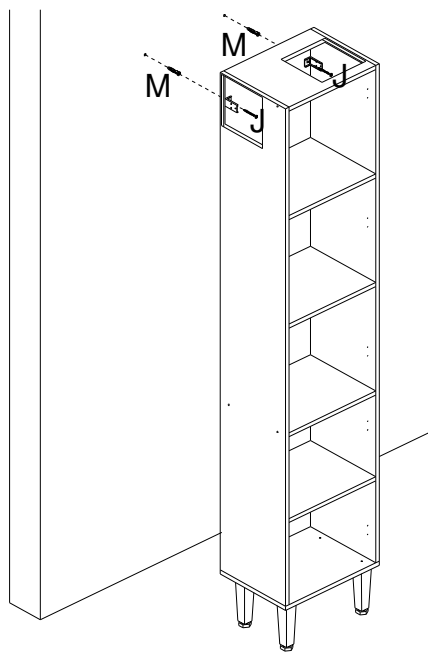

- PARA EVITAR QUALQUER ACIDENTE, É OBRIGATÓRIO FIXAR O MÓVEL NA PAREDE.

- TO AVOID ANY INJURY THE FURNITURE MUST BE FIXED ON THE WALL.

- PARA EVITAR CUALQUIER ACCIDENTE ES OBLIGATORIO ANCLAR EL MUEBLE EN LA PARED.

10

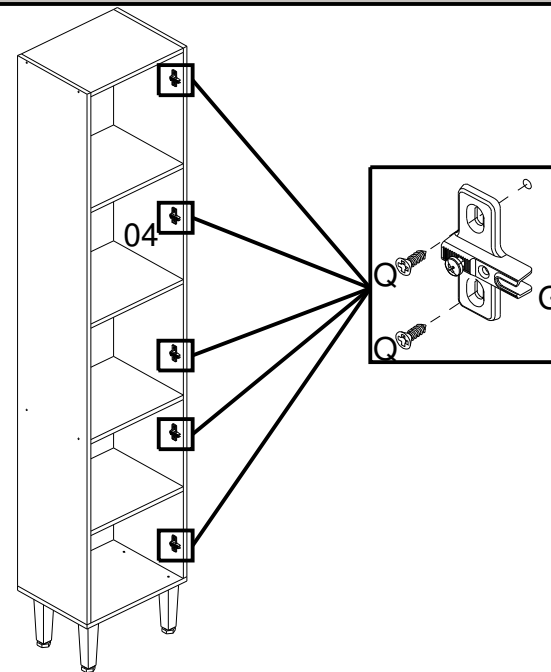

11

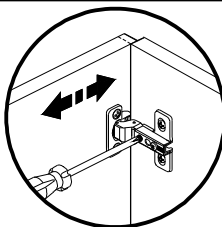
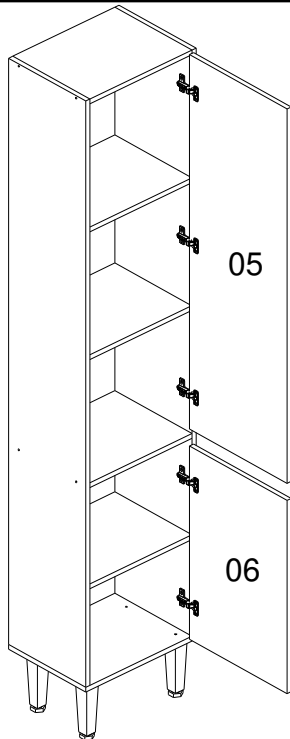
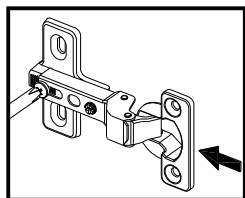

Horizontal Adjustment  
Regulagem Horizontal  
Ajuste Horizontal

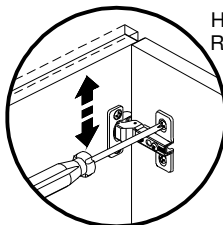

Vertical Adjustment  
Regulagem Vertical  
Ajuste Vertical

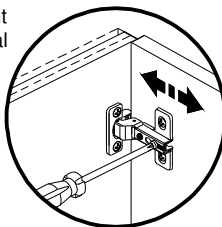

Depth Adjustment  
Regulagem Profundidade  
Ajuste Profundidad

12

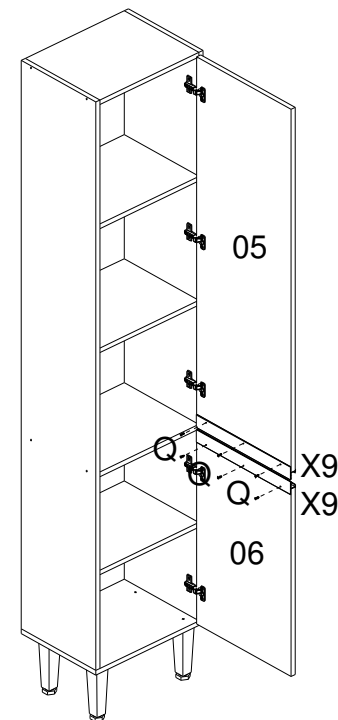

# PORTAS PARA ESQUERDA | Doors to the left | Puertas a la izquierda

09

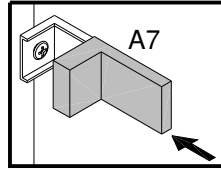
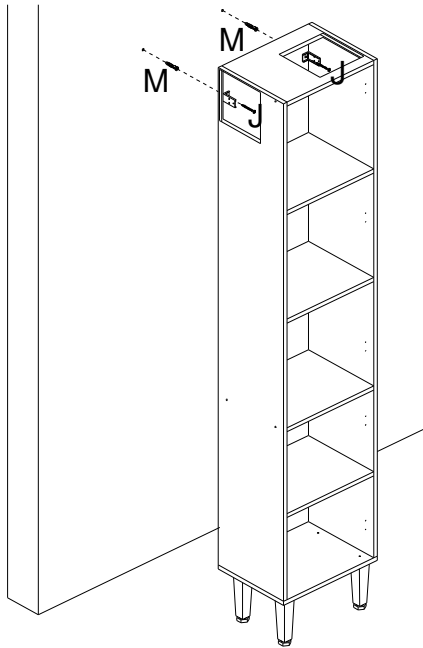

- PARA EVITAR QUALQUER ACIDENTE, É OBRIGATÓRIO FIXAR O MÓVEL NA PAREDE.  
 - TO AVOID ANY INJURY THE FURNITURE MUST BE FIXED ON THE WALL.  
 - PARA EVITAR CUALQUIER ACCIDENTE ES OBLIGATORIO ANCLAR EL MUEBLE EN LA PARED.

10

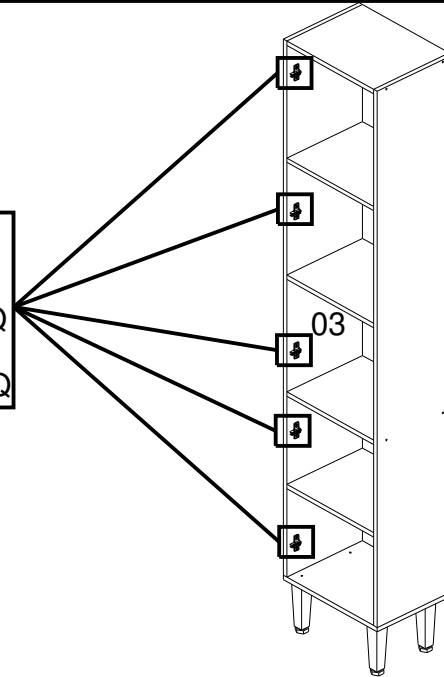
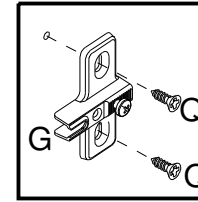

11

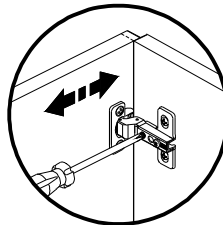
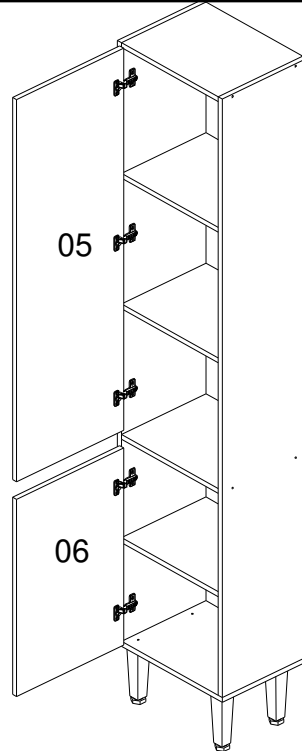
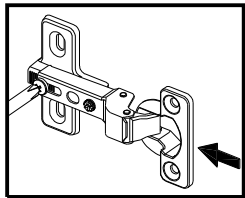

Horizontal Adjustment  
Regulagem Horizontal  
Ajuste Horizontal

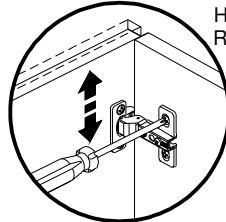

Vertical Adjustment  
Regulagem Vertical  
Ajuste Vertical

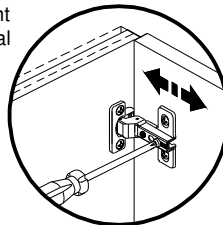

Depth Adjustment  
Regulagem Profundidade  
Ajuste Profundidad

12

