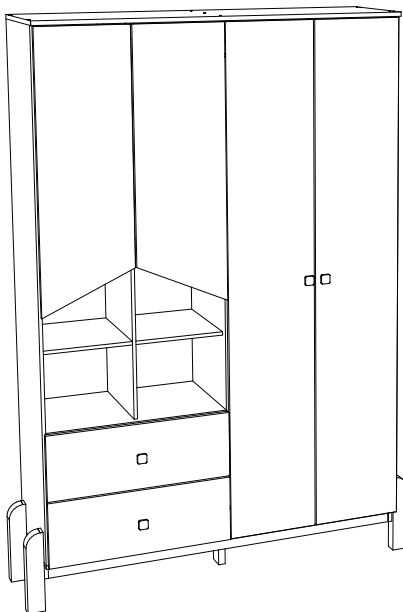
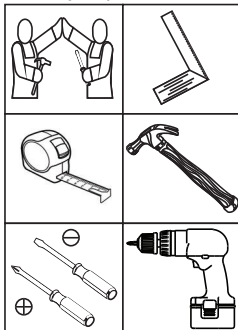

HENNInd. e Com. de Móveis Henn
Mondai - SC - Brasil

☎ +55 49 3674.3500

📱 @moveishenn
www.henn.com.br**INSTRUÇÕES DE
MONTAGEM**INSTRUCCIONES DE MONTAJE
ASSEMBLY INSTRUCTIONS**Roupeiro Ternura 4 Portas | Armario Ternura 4 Puertas |
Wardrobe Ternura 4 Doors**

I130-190 Branco/Jequitibá HP

**Requisitos para montagem
Requisitos para la montaje
Assembly Requirements**

Imagens meramente ilustrativas,
não acompanha o produto.
Imágenes ilustrativas, no incluidas
con el producto.
Illustrative images, not included
with the product.

AVISO

Para limpeza de seu móvel, use uma flanela seca ou umedecida, e não utilize produtos químicos que possam danificar seu produto.

SISTEMA DE MONTAGEM

O sistema de montagem dos produtos, funciona de acordo com a ordem crescente dos números indicados no desenho. Ex: 01, 02, 03, 04... até a conclusão da montagem.

ASSISTÊNCIA TÉCNICA

Para solicitação de Assistência Técnica você consumidor deverá entrar em contato com o Lojista o qual você realizou a compra deste produto e solicitar a assistência técnica das peças avariadas. A garantia abrange todas as peças, partes e componentes que eventualmente venham apresentar defeito de fabricação no prazo de 03 (três) meses, contando a partir da entrega do produto ao consumidor, mediante nota fiscal de compra. Se houver qualquer alteração na estrutura do produto ou ocorrer defeito por negligência do montador/consumidor em relação a instrução de montagem e manuseio, não será fornecido assistência técnica gratuita.

ADVERTENCIA

Para limpeza de su móvil, use una flanela seca o húmeda, y no utilice productos químicos que puedan dañar su producto.

SISTEMA DE MONTAJE

El sistema de montaje de los productos funciona de acuerdo con el orden creciente de los números indicados en el dibujo. Ej.: 01, 02, 03, 04... hasta la conclusión del montaje.

ASISTENCIA TÉCNICA

Para solicitar Asistencia Técnica, el consumidor debe comunicarse con el Comercio que usted realizó la compra de este producto y solicita asistencia técnica para las partes dañadas. La garantía cubre todas las partes, piezas y componentes que eventualmente puedan presentar defecto de fabricación en el plazo de 03 (tres) meses, contados a partir de la entrega del producto al consumidor, mediante factura de compra. Si se produce algún cambio en la estructura del producto o se produce un defecto por negligencia del montador/consumidor en relación con las instrucciones de montaje y manipulación, no se prestará asistencia técnica gratuita.

NOTICE

To clean your furniture, use a dry or wet cloth, and do not use chemicals that may damage your product.

ASSEMBLY SYSTEM

The products' assembly system works according to the increasing order of the indicated numbers. For example: 01, 02, 03, 04 ... to the end of the assembly.

TECHNICAL ASSISTANCE

To request Technical Assistance, the consumer must contact the retailer from whom you purchased this product and request technical assistance for the damaged parts. The warranty covers all parts, parts and components that may eventually present a manufacturing defect within a period of 03 (three) months, counting from the delivery of the product to the consumer, by means of a purchase invoice. If there is any change in the structure of the product or defect occurs due to negligence of the assembler/consumer in relation to the assembly and handling instruction, free technical assistance will not be provided.

ACESSÓRIOS | ACCESORIOS | ACCESSORIES

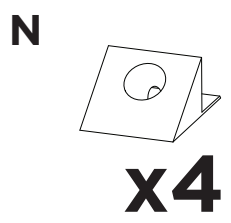
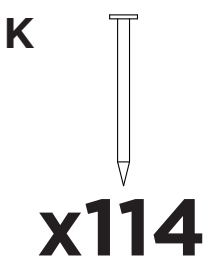
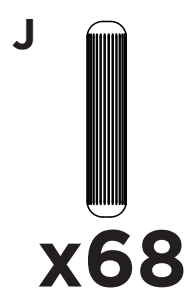
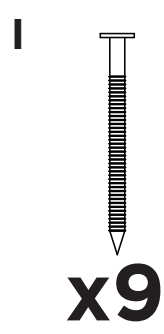
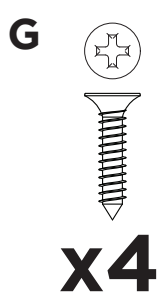
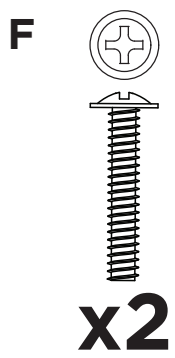
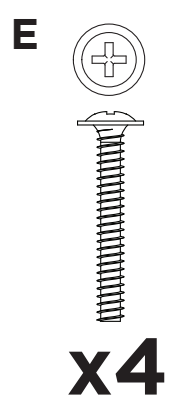
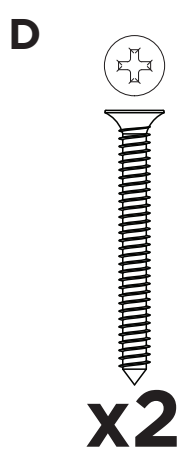
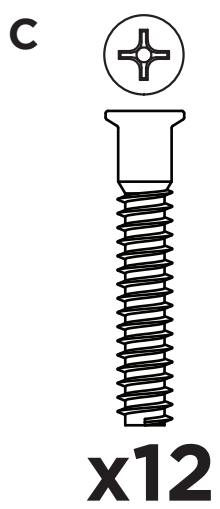
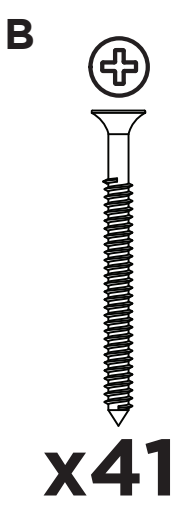
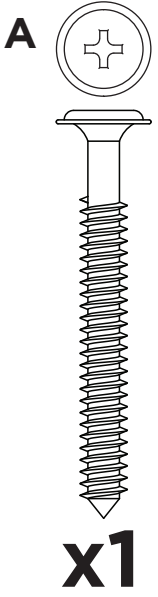

Parafusos em escala
Tornillos escalados
Scaled screws **1:1**

ACESSÓRIOS | ACCESORIOS | ACCESSORIES

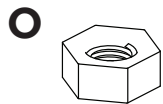

x2

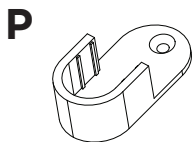

x2

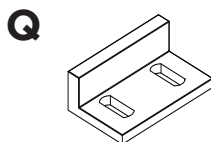

x2

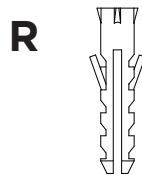

x1

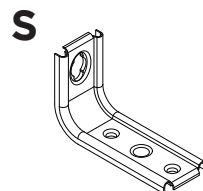

x1



x4

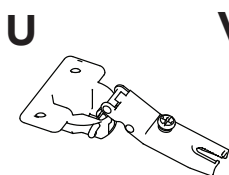

x10

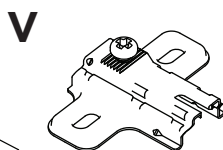

x10



x5



x2 PAR



x1



x1



x1

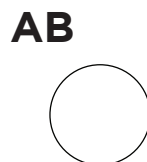

x26

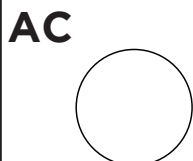

x4

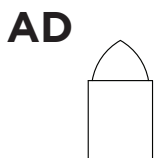

x3



x1



HENN

x1



x4

Parafusos em escala
Tornillos escalados
Scaled screws

1:1

LISTA DE PEÇAS | LISTA DE PIEZAS | LIST OF PIECES

Item	Caixa Caja Box	Qty Ctd Qty	Descrição Descripción Description	Dimensões (mm) Dimensiones (mm) Dimensions (mm)		
				Comprimento Largo Length	Largura Ancho Width	Espessura Grosor Thickness
1	1/2	04	PÉ PIE FOOT	280	60	40
2	2/2	02	TRAVESSA LATERAL TRAVESAÑO LATERAL SIDE TRAY	301	50	15
3	2/2	02	TRAVESSA MAIOR TRAVESAÑO MÁS GRANDE BIGGER TRAY	1270	50	15
4	2/2	01	TRAVESSA TRAVESAÑO TRAY	270	50	12
5	1/2	01	PÉ CENTRAL PIE CENTRAL CENTER FOOT	160	60	25
6	1/2	01	LATERAL ESQUERDA LADO IZQUIERDO LEFT SIDE	1813	380	12
7	1/2	01	DIVISÃO DIVISIÓN DIVISION	1813	380	12
8	1/2	01	TAMPO DAS GAVETAS TAPA DE LOS CAJONES TOP OF DRAWERS	632	380	12
9	1/2	01	DIVISÃO MENOR DIVISIÓN MENOR MINOR DIVISION	540	351	12
10	1/2	02	PRATELEIRA MENOR ESTANTE MENOR MINOR SHELF	350	310	12
11	1/2	01	PRATELEIRA SUPERIOR ESTANTE SUPERIOR TOP SHELF	632	380	12
12	1/2	01	BASE BASE BASE	1300	380	12
13	1/2	01	LATERAL DIREITA LADO DERECHO RIGHT SIDE	1813	380	12
14	1/2	04	PRATELEIRA ESTANTE SHELF	632	350	12
15	1/2	01	TAMPO TAPA TOP	1301	397	15
16	2/2	02	FUNDO EXTERNO FONDO EXTERNO EXTERNAL BOTTOM	1018	323	3
17	2/2	02	FUNDO SUPERIOR FONDO MÁS ALTO TOP BOTTOM	819	323	3
18	1/2	02	FUNDO MAIOR FONDO MÁS GRANDE BIGGER BOTTOM	1838	323	3
19	2/2	01	PORTA ESQUERDA PUERTA IZQUIERDA LEFT DOOR	955	319	15
20	2/2	01	PORTA DIREITA PUERTA DERECHA RIGHT DOOR	955	319	15
21	2/2	02	PORTA MAIOR PUERTA MÁS GRANDE BIGGER DOOR	1815	319	15
22	2/2	02	FRENTE DE GAVETA FRENTE DEL CAJÓN DRAWER FRONT	642	230	15
23	1/2	04	LADO DE GAVETA LATERAL DEL CAJÓN DRAWER SIDE	350	122	12
24	1/2	02	FUNDO DE GAVETA FONDO DEL CAJÓN DRAWER BOTTOM	594	361	3
25	1/2	02	RIPA DE TRÁS TRAVESAÑO TRASERO REAR CLAPBOARD	607	122	12



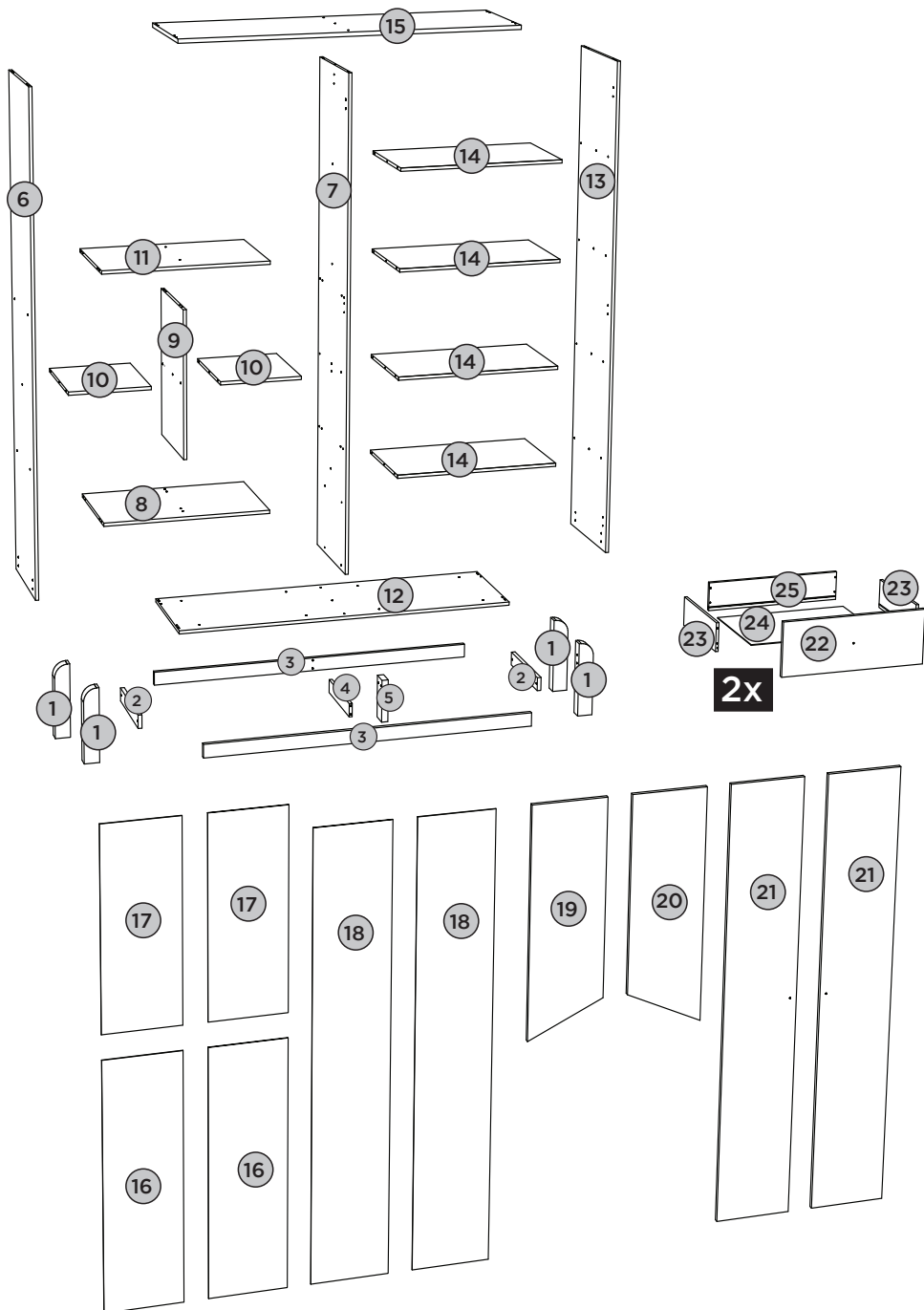

LISTA DE PEÇAS | LISTA DE PIEZAS | LIST OF PIECES



PEÇAS REQUERIDAS

1	PÉ	x4
3	TRAVESSA MAIOR	x2
4	TRAVESSA	x1
5	PÉ CENTRAL	x1

ACESSÓRIOS REQUERIDOS

H		06
I		05
J		04
M		06
W		05



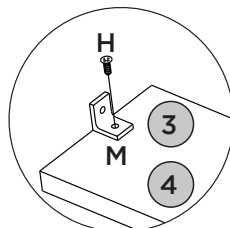
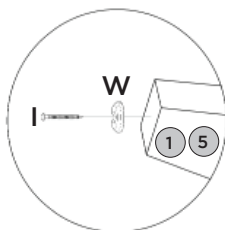
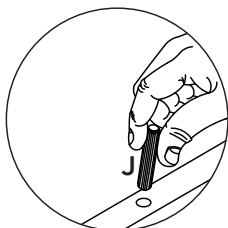
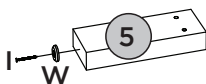
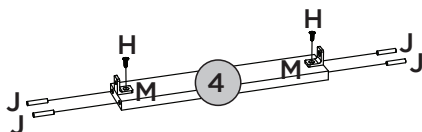
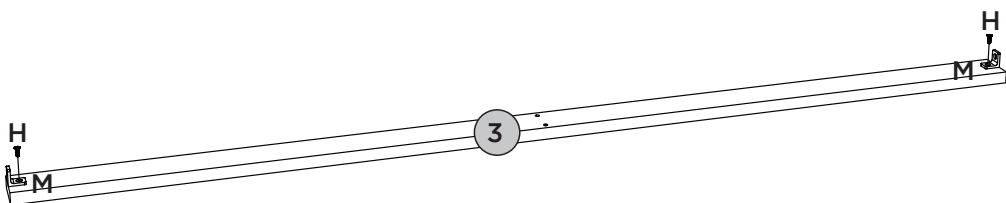
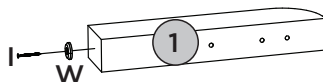
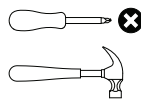

FERRAMENTAS NECESSÁRIAS



PEÇAS REQUERIDAS

6	LATERAL ESQUERDA	x1
7	DIVISÃO	x1
13	LATERAL DIREITA	x1

ACESSÓRIOS REQUERIDOS

H		29
J		12
P		02
V		08
X		02

FERRAMENTAS NECESSÁRIAS

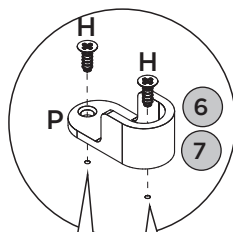
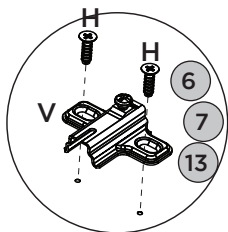
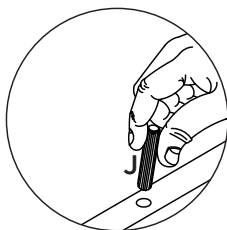
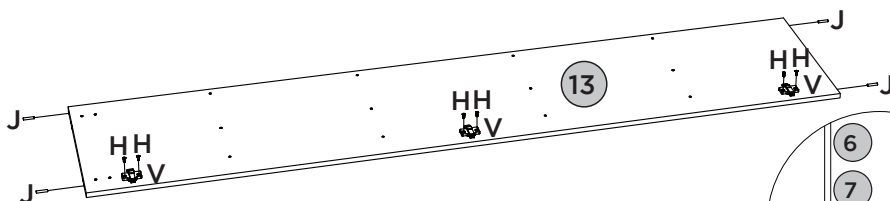
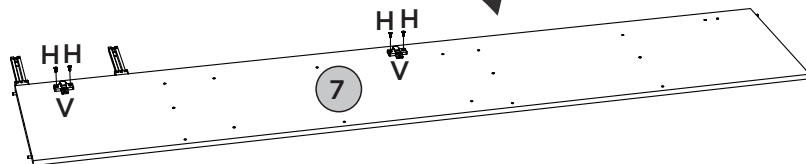
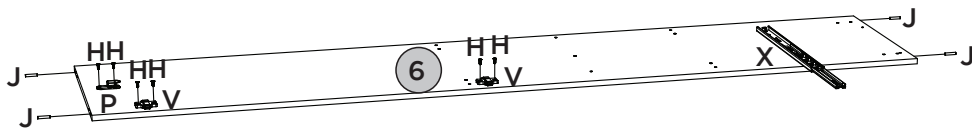
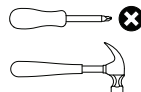

**Observe:
Furos
pré-marcados**

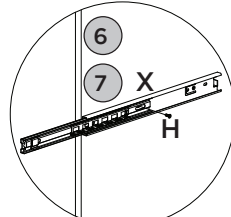
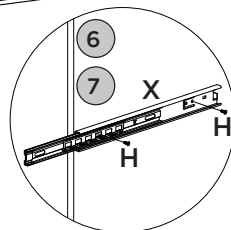

PEÇAS REQUERIDAS

8	TAMPO DAS GAVETAS	x1
9	DIVISÃO MENOR	x1
10	PRATELEIRA MENOR	x2
11	PRATELEIRA EXTERNA	x1
14	PRATELEIRA	x4

ACESSÓRIOS REQUERIDOS

J		36
---	---	----

FERRAMENTAS NECESSÁRIAS

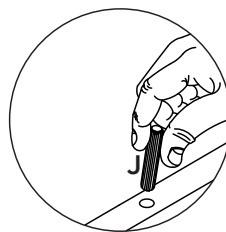
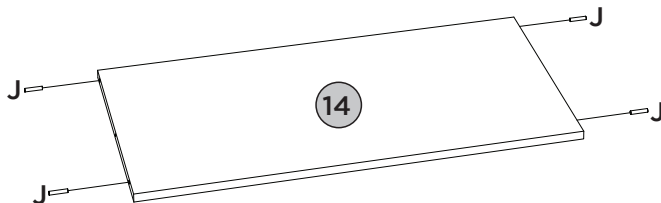
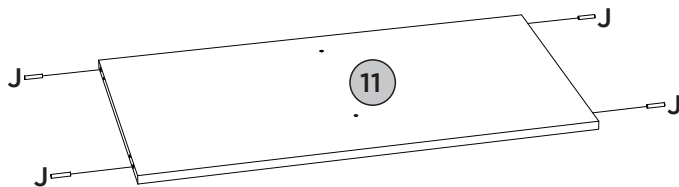
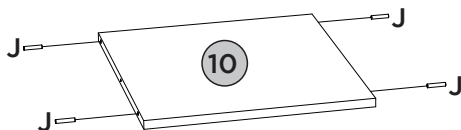
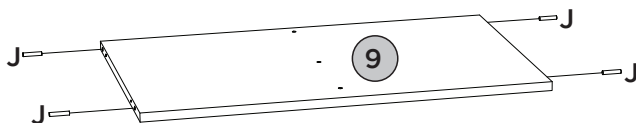
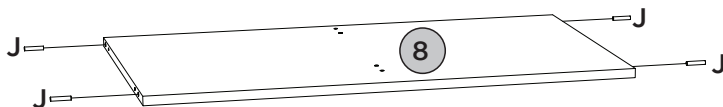
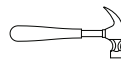

PASSO 4

ITM/I130-

PEÇAS REQUERIDAS

1	PÉ	x4
2	TRAVESSA LATERAL	x2

ACESSÓRIOS REQUERIDOS

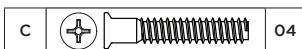

FERRAMENTAS NECESSÁRIAS

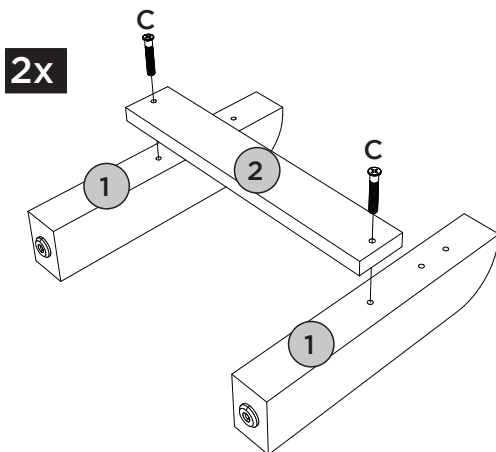
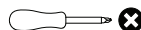

PASSO 5

PEÇAS REQUERIDAS

3	TRAVESSA MAIOR	x2
4	TRAVESSA	x1

ACESSÓRIOS REQUERIDOS





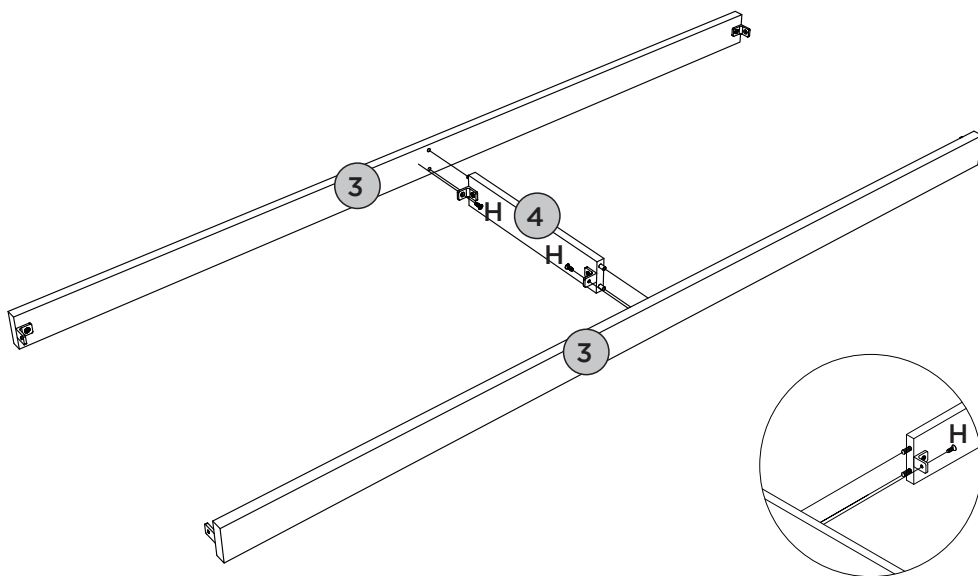
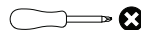

FERRAMENTAS NECESSÁRIAS



PASSO 6**PEÇAS REQUERIDAS**

5	PÉ CENTRAL	x1
---	------------	----

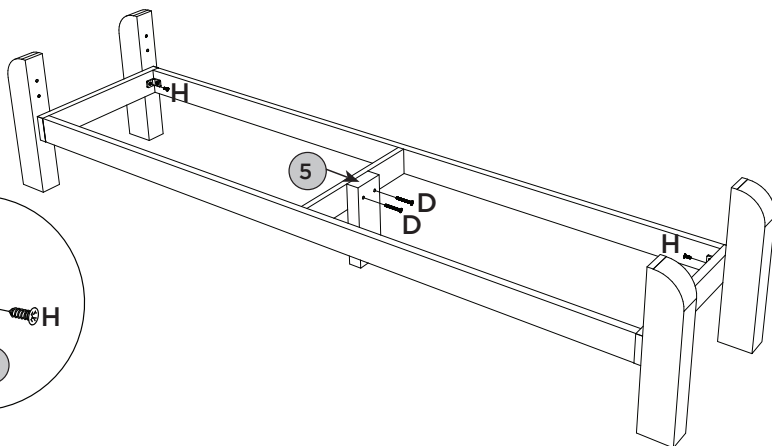
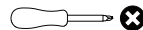

ACESSÓRIOS REQUERIDOS

D			02
H			04

FERRAMENTAS NECESSÁRIAS**PASSO 7****PEÇAS REQUERIDAS**

8	TAMPO DAS GAVETAS	x1
9	DIVISÃO MENOR	x1
10	PRATELEIRA MENOR	x1
11	PRATELEIRA EXTERNA	x1

ACESSÓRIOS REQUERIDOS

B			05
---	---	---	----

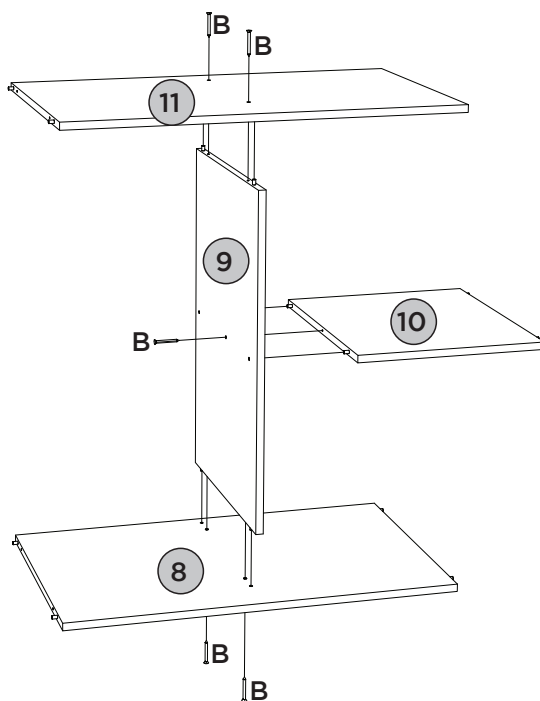
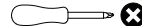
FERRAMENTAS NECESSÁRIAS

PEÇAS REQUERIDAS

6	LATERAL ESQUERDA	x1
7	DIVISÃO	x1
10	PRATELEIRA MENOR	x1

ACESSÓRIOS REQUERIDOS

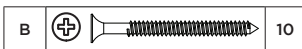

FERRAMENTAS NECESSÁRIAS

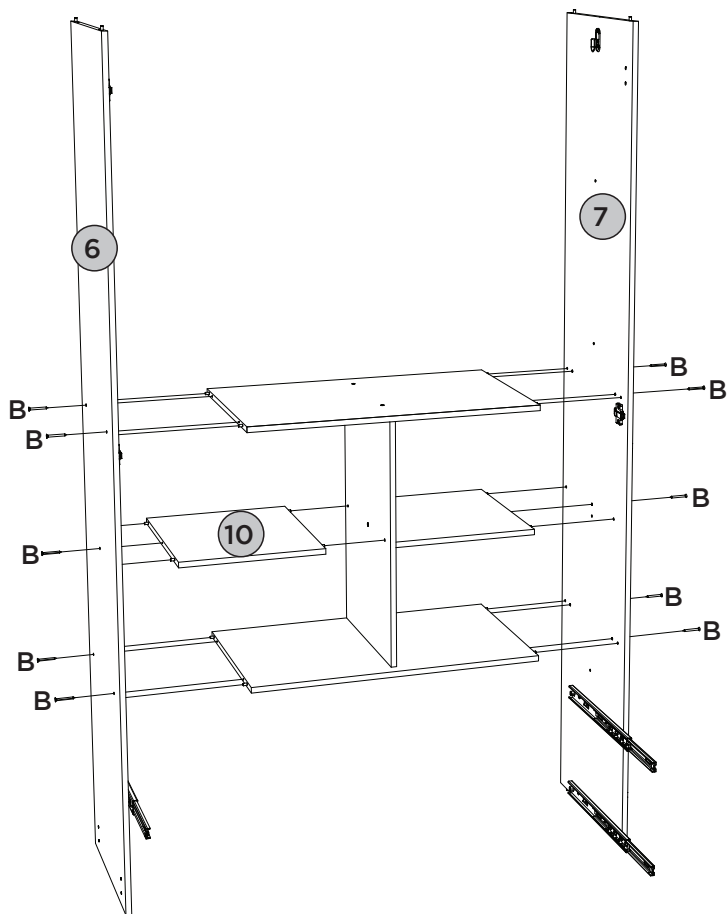
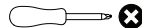

PASSO 9

ITM/1130-

PEÇAS REQUERIDAS

12	BASE	x1
13	LATERAL DIREITA	x1
14	PRATELEIRA	x4

ACESSÓRIOS REQUERIDOS

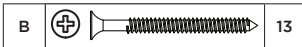



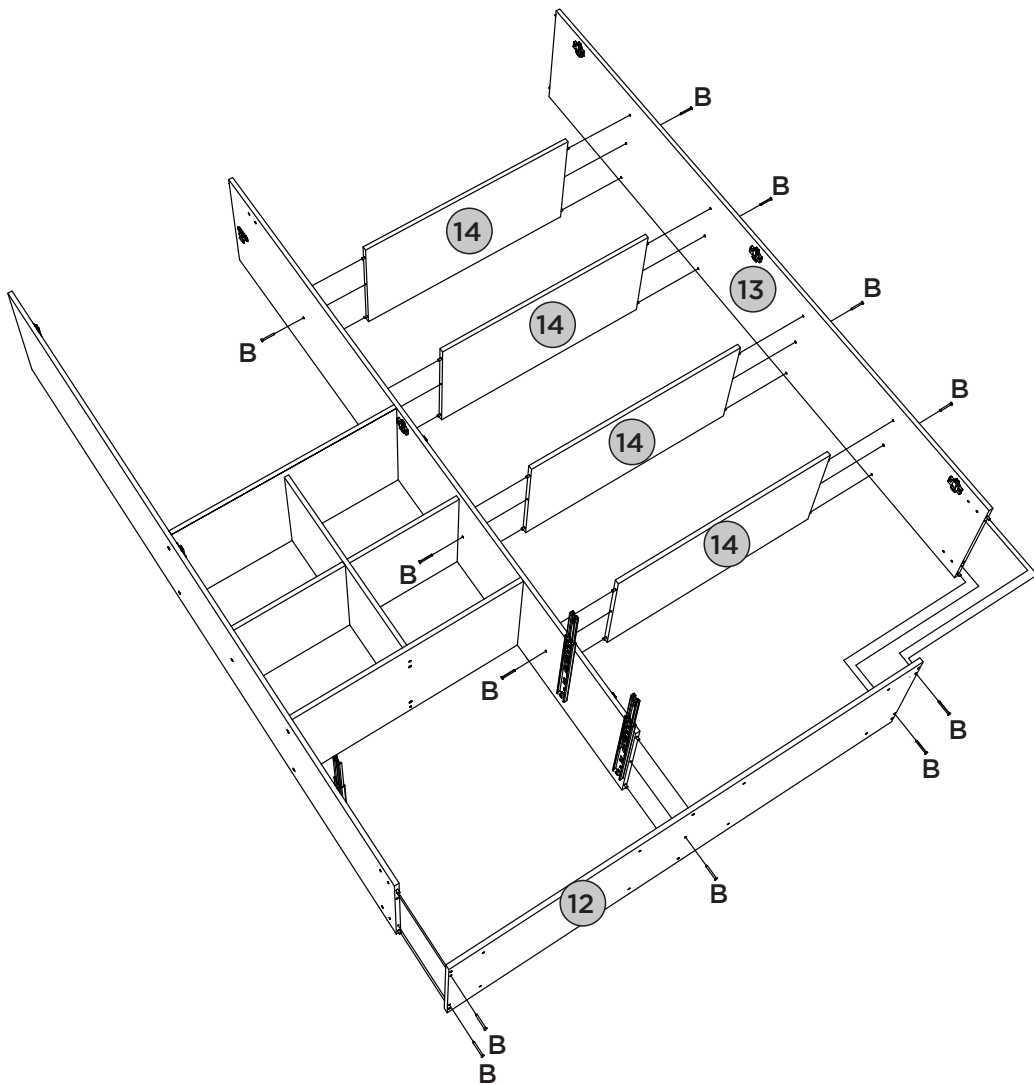
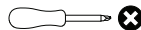

FERRAMENTAS NECESSÁRIAS



PEÇAS REQUERIDAS

15	TAMPO	x1
----	-------	----

ACESSÓRIOS REQUERIDOS

B			13
C			08

FERRAMENTAS NECESSÁRIAS

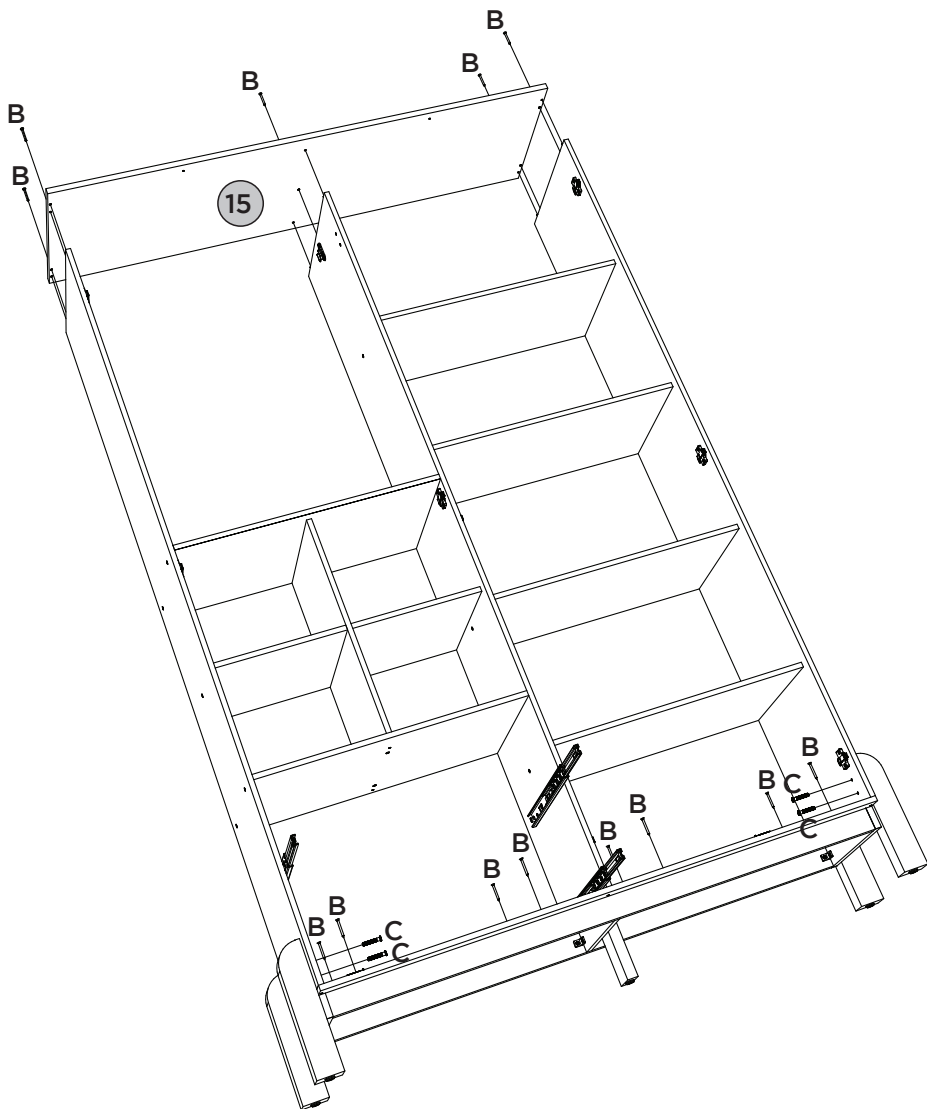





PASSO 11

ITM/1130-

PEÇAS REQUERIDAS

16	FUNDO EXTERNO	x2
17	FUNDO SUPERIOR	x2
18	FUNDO MAIOR	x2

ACESSÓRIOS REQUERIDOS

K		114
L		24
Y		01
Z		01



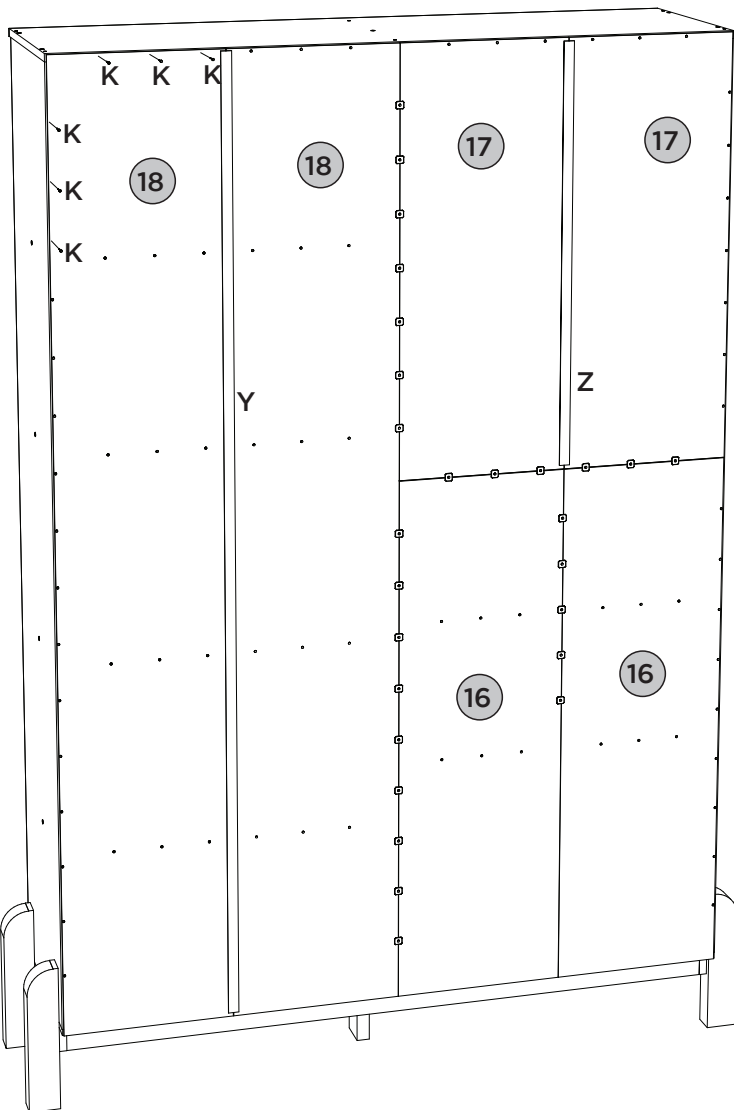

FERRAMENTAS NECESSÁRIAS



PEÇAS REQUERIDAS

19	PORTA ESQUERDA	x1
20	PORTA DIREITA	x1
21	PORTA MAIOR	x2

ACESSÓRIOS REQUERIDOS

E		02
H		20
T		02
U		10

FERRAMENTAS NECESSÁRIAS

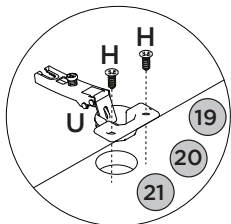
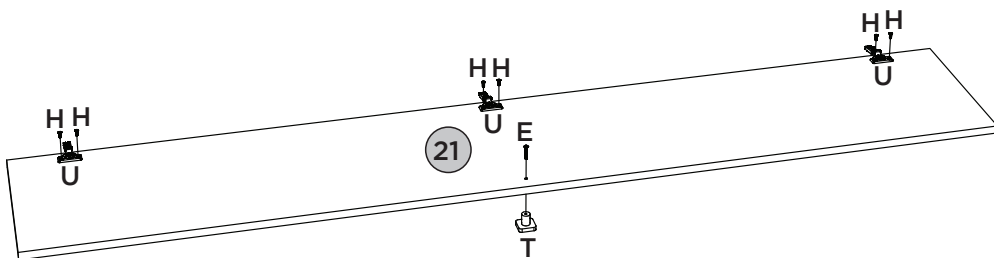
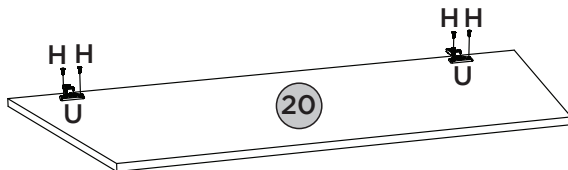
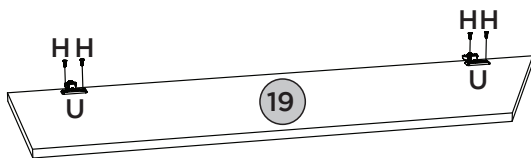
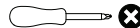

Vídeo: Instalar e regular Dobradiças







Vídeo: Instale y ajuste las bisagras

Video: Install and adjust hinges

PEÇAS REQUERIDAS

19	PORTA ESQUERDA	x1
20	PORTA DIREITA	x1
21	PORTA MAIOR	x2

ACESSÓRIOS REQUERIDOS

F		02
H		03
O		02
Q		02
V		02
X		01
AA		01

FERRAMENTAS NECESSÁRIAS

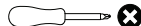

AG		04
----	---	----

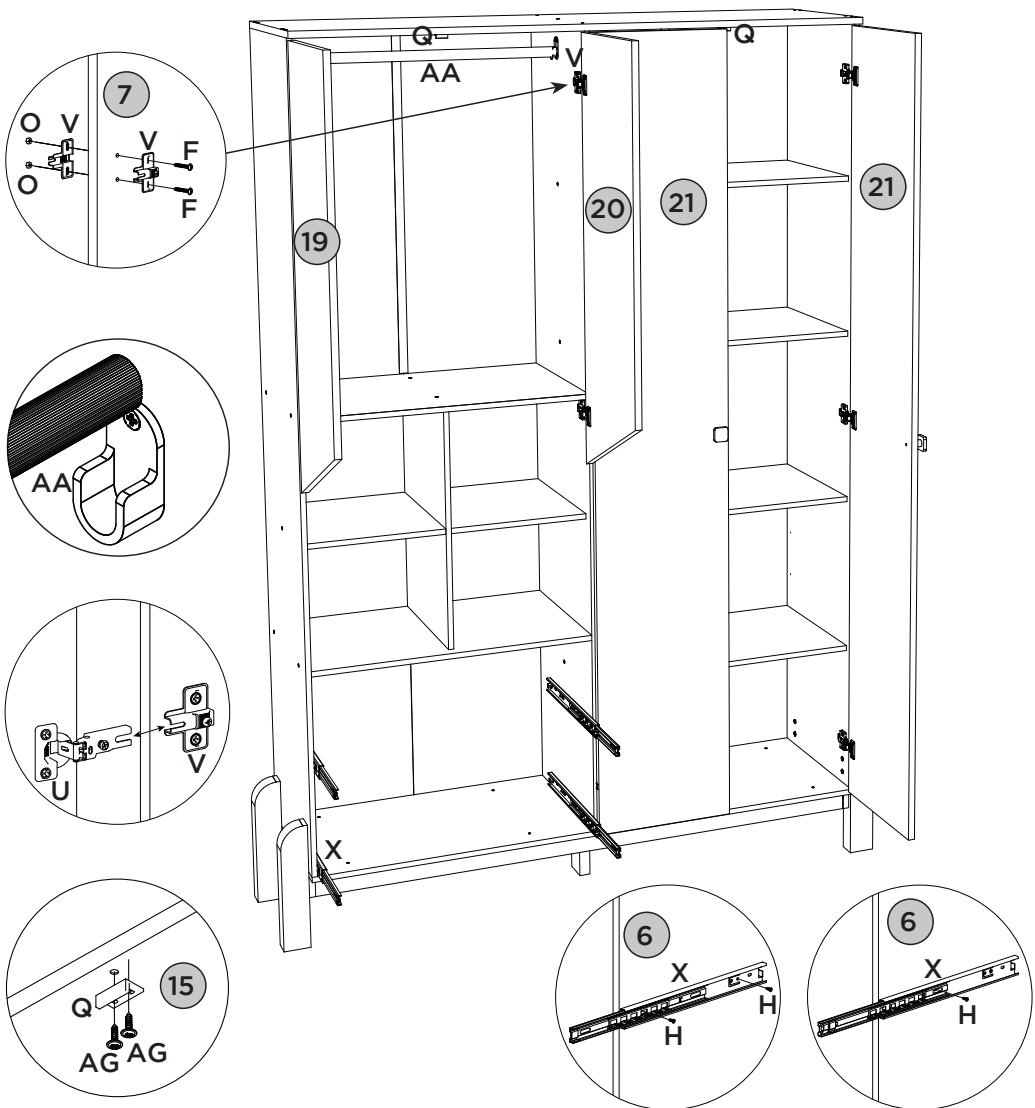

PASSO 14

ITM/I130-

PEÇAS REQUERIDAS

23	LADO DE GAVETA	x4
----	----------------	----

ACESSÓRIOS REQUERIDOS

J		16
AE		

FERRAMENTAS NECESSÁRIAS

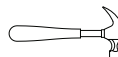

4x

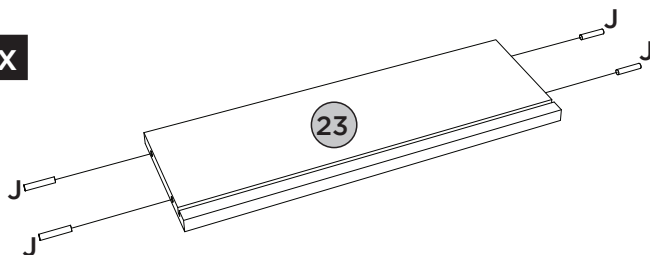



PASSO 15

PEÇAS REQUERIDAS

22	FRENTE DE GAVETA	x2
23	LADO DE GAVETA	x4
24	FUNDO DE GAVETA	x2

ACESSÓRIOS REQUERIDOS

H		08
M		04
AE		

FERRAMENTAS NECESSÁRIAS

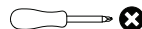

2x

1º

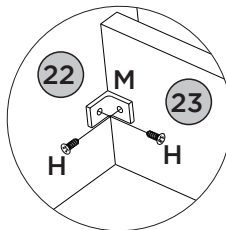
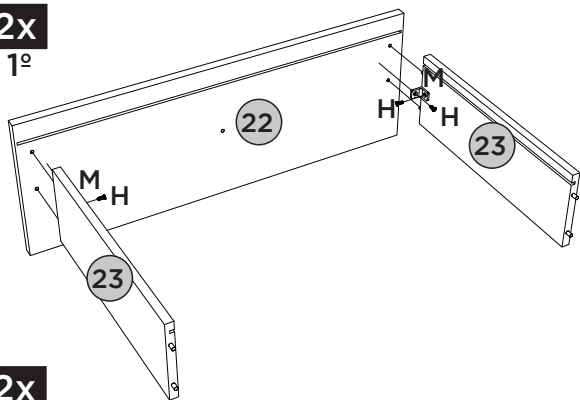

2x

2º

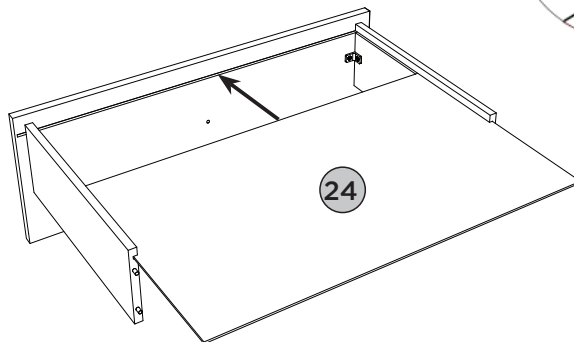
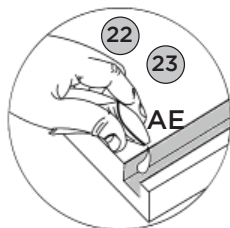

PEÇAS REQUERIDAS

25	RIPA DE TRÁS	x2
----	--------------	----

ACESSÓRIOS REQUERIDOS

E		02
G		04
H		12
I		04
N		04

FERRAMENTAS NECESSÁRIAS

		02
		02
		02

2x
3º

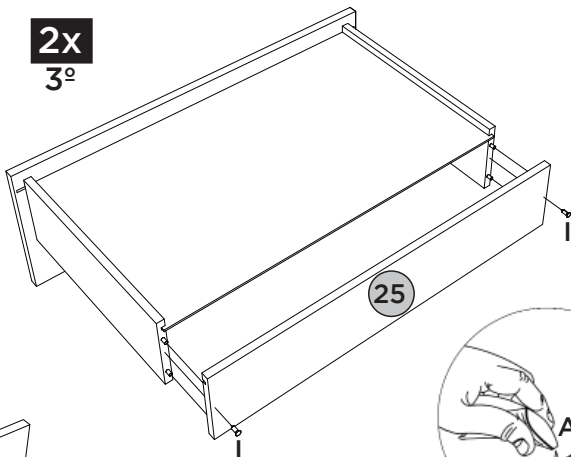

2x
4º

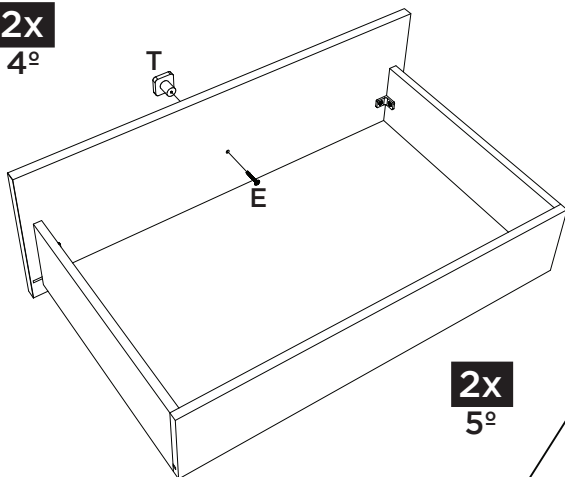

Deixar 3mm de distância da frente de gaveta.

Deje una separación de 3mm del frente del cajón.





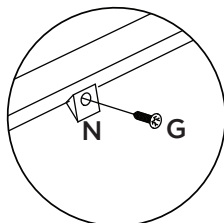
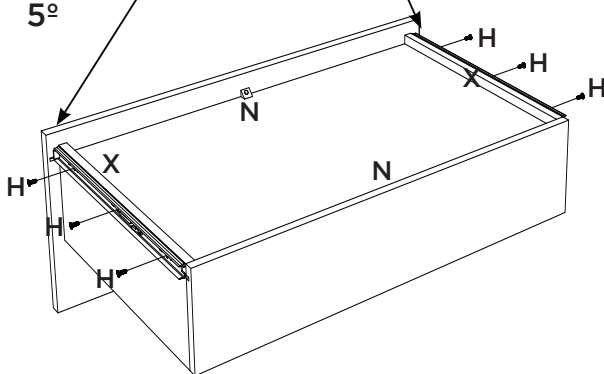

Leave 3mm away from the front of the drawer.

2x
5º



ACESSÓRIOS REQUERIDOS

FERRAMENTAS NECESSÁRIAS

A		01	AB		26
H		02	AC		04
R		01	AD		03
S		01	AF	HENN	01

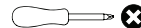

Imprescindível a fixação do produto na parede, a não colocação destas ferragens para fixação (A, H, R, e S), poderá permitir que o produto vire, causando acidente.

Es imprescindible la fijación del producto en la pared, la no colocación de estos herrajes para fijación (A, H, R, y S), podrá permitir que el El producto se vuelve, causando accidente.

Indispensable to fix the product on the wall, not the placement of these attachment fittings (A, H, R and S) may allow the product to turn, causing an accident.

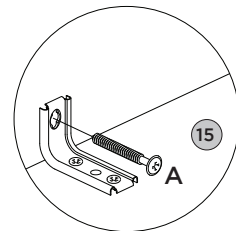
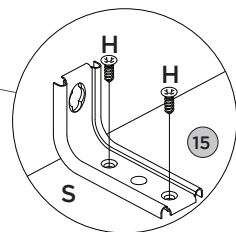
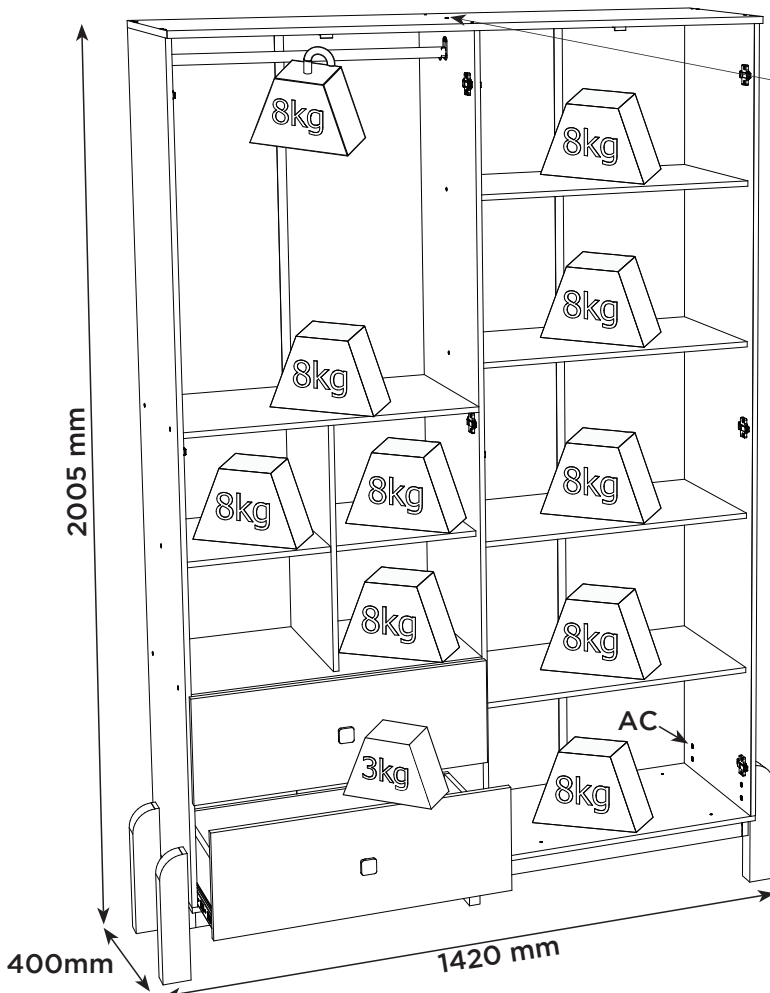

PERFECT CORRECTION
CORRECCIÓN PERFECTA

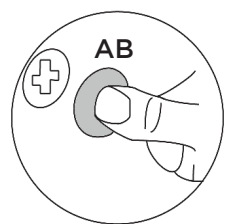
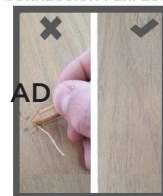

Pesos máximos recomendados com carga distribuída
Peso máximo recomendado con la carga distribuida
Recommended maximum weight with distributed load.

Produto Concluído
Producto terminado
Finished Product

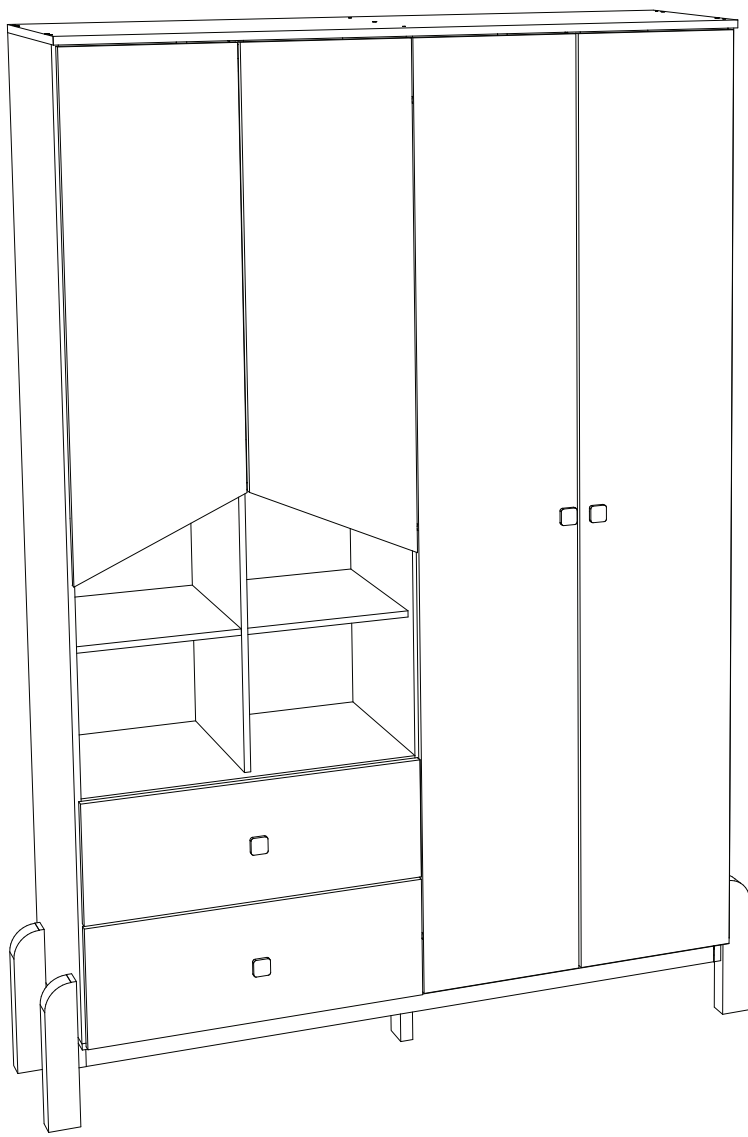

HENNInd. e Com. de Móveis Henn
Mondai - SC - Brasil

☎ +55 49 3674.3500

📷 @moveishenn
www.henn.com.br**INSTRUÇÕES DE
MONTAGEM**INSTRUCCIONES DE MONTAJE
ASSEMBLY INSTRUCTIONS**Cômoda Ternura 1 Porta 3 Gavetas |**
Cómoda Ternura 1 Puerta 3 Cajones | Tenderness Dresser 1 Door 3 Drawers

1725-190 Branco/Jequitibá HP

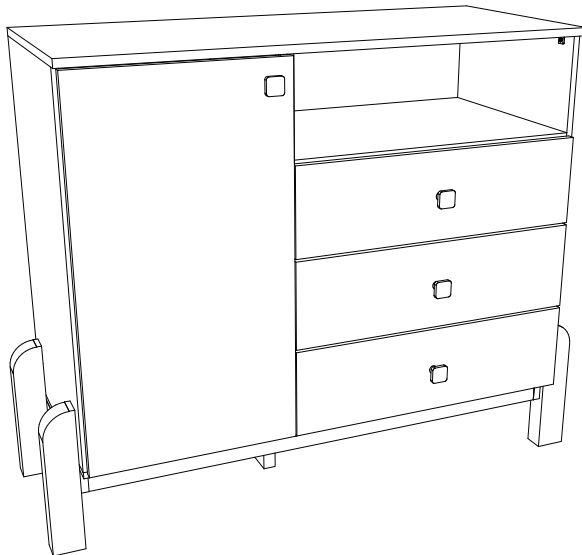
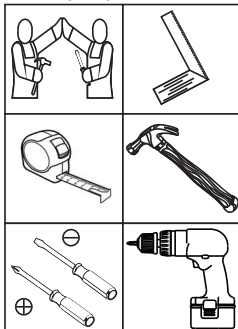
**Requisitos para montagem**
Requisitos para la montaje
Assembly Requirements

Imagens meramente ilustrativas,
não acompanha o produto.
Imágenes ilustrativas, no incluidas
con el producto.
Illustrative images, not included
with the product.

AVISO

Para limpeza de seu móvel, use uma flanela seca ou umedecida, e não utilize produtos químicos que possam danificar seu produto.

SISTEMA DE MONTAGEM

O sistema de montagem dos produtos, funciona de acordo com a ordem crescente dos números indicados no desenho. Ex: 01, 02, 03, 04... até a conclusão da montagem.

ASSISTÊNCIA TÉCNICA

Para solicitação de Assistência Técnica você consumidor deverá entrar em contato com o Lojista o qual você realizou a compra deste produto e solicitar a assistência técnica das peças avariadas. A garantia abrange todas as peças, partes e componentes que eventualmente venham apresentar defeito de fabricação no prazo de 03 (três) meses, contando a partir da entrega do produto ao consumidor, mediante nota fiscal de compra. Se houver qualquer alteração na estrutura do produto ou ocorrer defeito por negligência do montador/consumidor em relação a instrução de montagem e manuseio, não será fornecido assistência técnica gratuita.

ADVERTENCIA

Para limpeza de su móvil, use una flanela seca o húmeda, y no utilice productos químicos que puedan dañar su producto.

SISTEMA DE MONTAJE

El sistema de montaje de los productos funciona de acuerdo con el orden creciente de los números indicados en el dibujo. Ej.: 01, 02, 03, 04... hasta la conclusión del montaje.

ASISTENCIA TÉCNICA

Para solicitar Asistencia Técnica, el consumidor debe comunicarse con el Comercio que usted realizó la compra de este producto y solicita asistencia técnica para las partes dañadas. La garantía cubre todas las partes, piezas y componentes que eventualmente puedan presentar defecto de fabricación en el plazo de 03 (tres) meses, contados a partir de la entrega del producto al consumidor, mediante factura de compra. Si se produce algún cambio en la estructura del producto o se produce un defecto por negligencia del montador/consumidor en relación con las instrucciones de montaje y manipulación, no se prestará asistencia técnica gratuita.

NOTICE

To clean your furniture, use a dry or wet cloth, and do not use chemicals that may damage your product.

ASSEMBLY SYSTEM

The products' assembly system works according to the increasing order of the indicated numbers. For example: 01, 02, 03, 04 ... to the end of the assembly.

TECHNICAL ASSISTANCE

To request Technical Assistance, the consumer must contact the retailer from whom you purchased this product and request technical assistance for the damaged parts. The warranty covers all parts, parts and components that may eventually present a manufacturing defect within a period of 03 (three) months, counting from the delivery of the product to the consumer, by means of a purchase invoice. If there is any change in the structure of the product or defect occurs due to negligence of the assembler/consumer in relation to the assembly and handling instruction, free technical assistance will not be provided.

ACESSÓRIOS | ACCESORIOS | ACCESSORIES

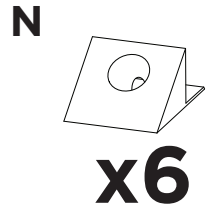
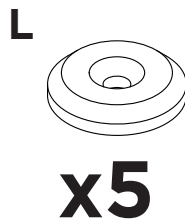
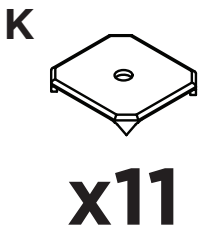
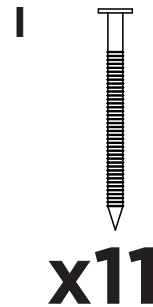
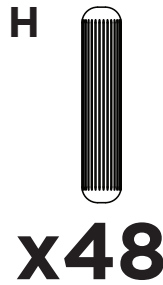
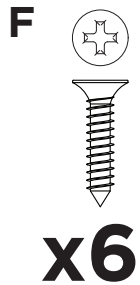
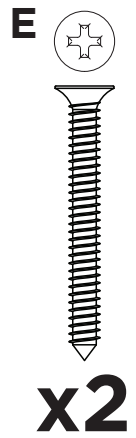
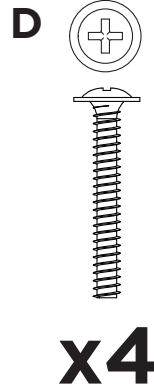
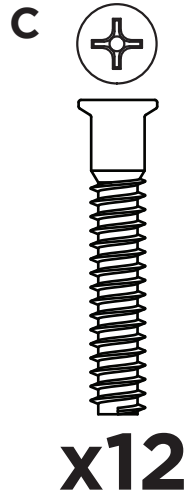
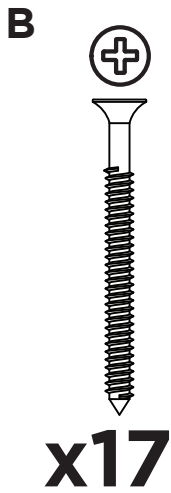
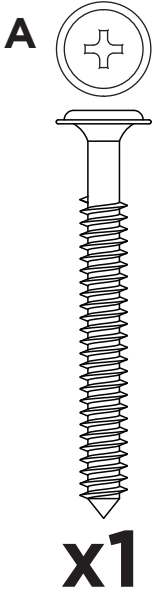

ACESSÓRIOS | ACCESORIOS | ACCESSORIES

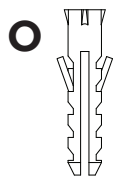

x1

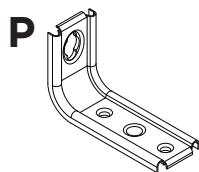

x1



x4

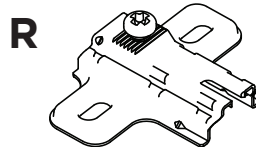

x2

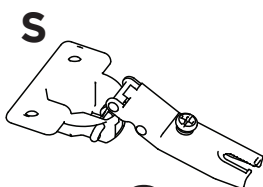

x2



x3 PAR



x1

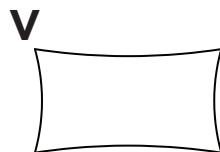

x2



x8

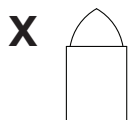

x3



HENN

x1

LISTA DE PEÇAS | LISTA DE PIEZAS | LIST OF PIECES

Item	Caixa Caja Box	Qty Ctd Qty	Descrição Descripción Description	Dimensões (mm) Dimensiones (mm) Dimensions (mm)		
				Comprimento Largo Length	Largura Ancho Width	Espessura Grosor Thickness
1	1/1	04	PÉ PIE FOOT	280	60	40
2	1/1	02	TRAVESSA LATERAL TRAVESAÑO LATERAL SIDE TRAY	331	50	15
3	1/1	02	TRAVESSA MAIOR TRAVESAÑO MÁS GRANDE BIGGER TRAY	950	50	15
4	1/1	01	TRAVESSA TRAVESAÑO TRAY	300	50	12
5	1/1	01	PÉ CENTRAL PIE CENTRAL CENTER FOOT	160	60	25
6	1/1	01	BASE BASE BASE	980	410	12
7	1/1	01	LATERAL ESQUERDA LADO IZQUIERDO LEFT SIDE	704	410	12
8	1/1	01	PRATELEIRA ESTANTE SHELF	379	379	12
9	1/1	01	DIVISÃO DIVISIÓN DIVISION	704	410	12
10	1/1	01	TAMPO DAS GAVETAS TAPA DE LOS CAJONES TOP OF DRAWERS	565	410	12
11	1/1	01	LATERAL DIREITA LADO DERECHO RIGHT SIDE	704	410	12
12	1/1	01	TAMPO TAPA TOP	981	427	15
13	1/1	01	FUNDO MAIOR FONDO MÁS GRANDE BIGGER BOTTOM	729	395	3
14	1/1	01	FUNDO MENOR FONDO MÁS PEQUEÑO SMALLER BOTTOM	581	203	3
15	1/1	02	FUNDO CRU FONDO CRUDO RAW FUND	581	261	3
16	1/1	01	PORTA PUERTA DOOR	705	390	15
17	1/1	03	FRENTE DE GAVETA FRENTE DEL CAJÓN DRAWER FRONT	575	170	15
18	1/1	06	LADO DE GAVETA LATERAL DEL CAJÓN DRAWER SIDE	350	122	12
19	1/1	03	FUNDO DE GAVETA FONDO DEL CAJÓN DRAWER BOTTOM	527	361	3
20	1/1	03	RIPA DE TRÁS TRAVESAÑO TRASERO REAR CLAPBOARD	540	122	12



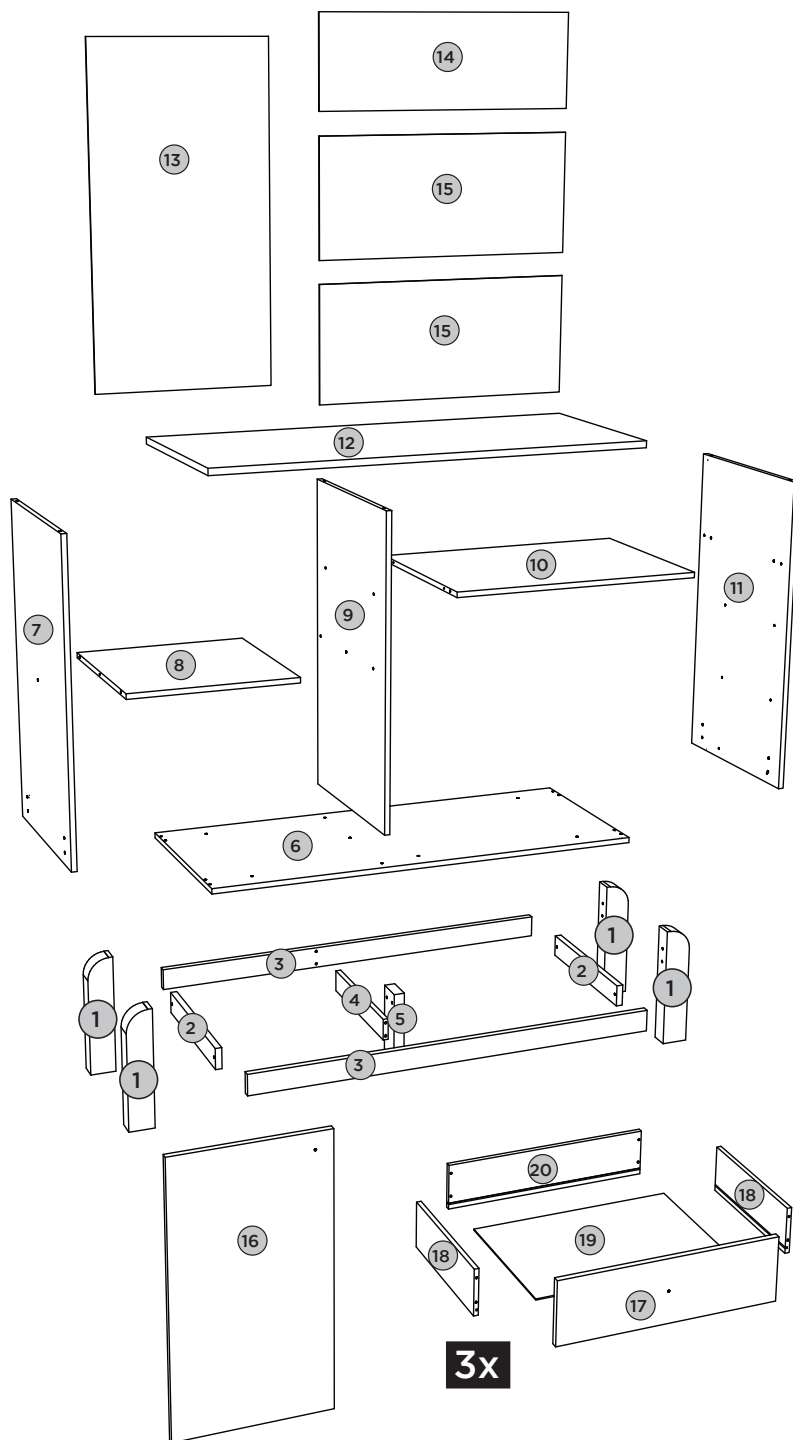

LISTA DE PEÇAS | LISTA DE PIEZAS | LIST OF PIECES



PEÇAS REQUERIDAS

1	PÉ	x4
3	TRAVESSA MAIOR	x2
4	TRAVESSA	x1
5	PÉ CENTRAL	x1

ACESSÓRIOS REQUERIDOS

G		06
H		04
I		05
L		05
M		06



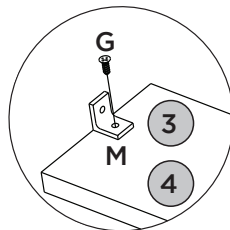
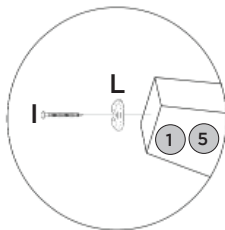
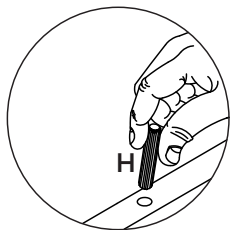
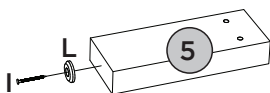
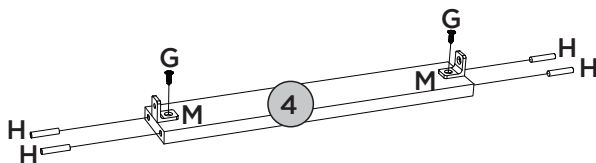
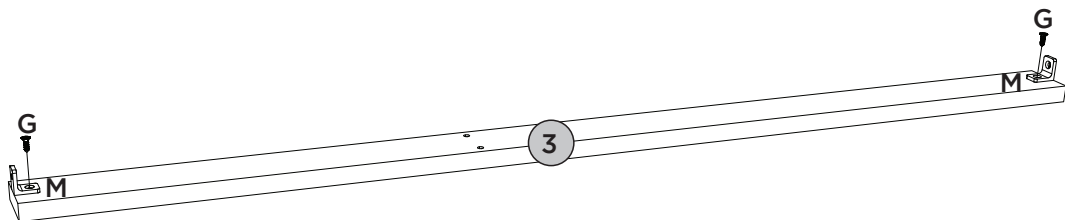
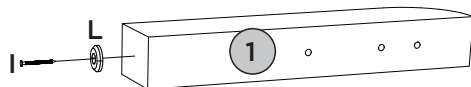
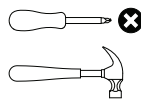

FERRAMENTAS NECESSÁRIAS



PEÇAS REQUERIDAS

7	LATERAL ESQUERDA	x1
8	PRATELEIRA	x1
9	DIVISÃO	x1
10	TAMPO DAS GAVETAS	x1
11	LATERAL DIREITA	x1

ACESSÓRIOS REQUERIDOS

G		25
H		20
M		06
R		02
T		03

FERRAMENTAS NECESSÁRIAS

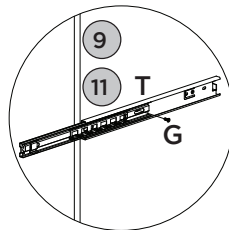
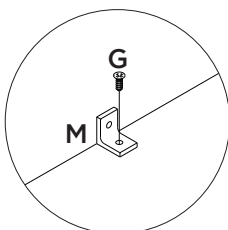
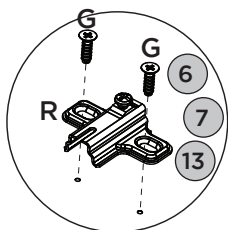
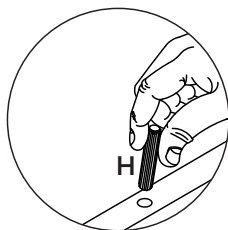
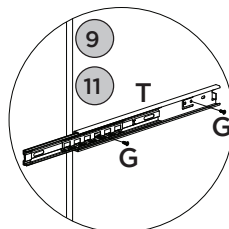
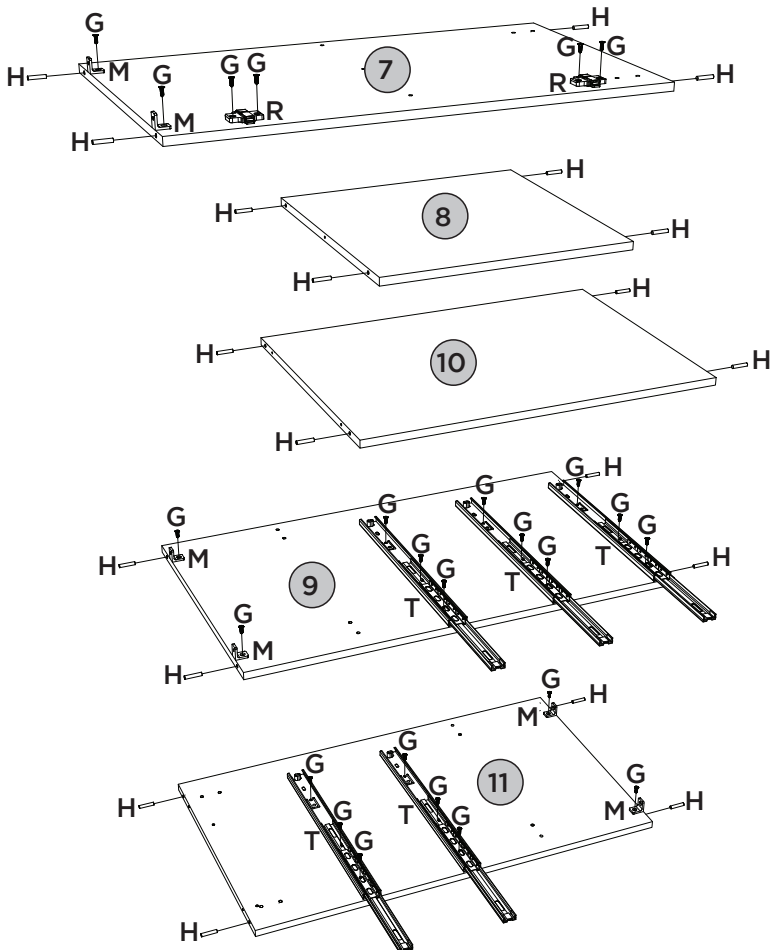
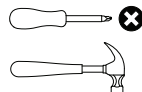

PASSO 3

ITM/1725-

PEÇAS REQUERIDAS

1	PÉ	x4
2	TRAVESSA LATERAL	x2

ACESSÓRIOS REQUERIDOS

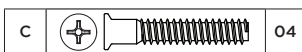

FERRAMENTAS NECESSÁRIAS

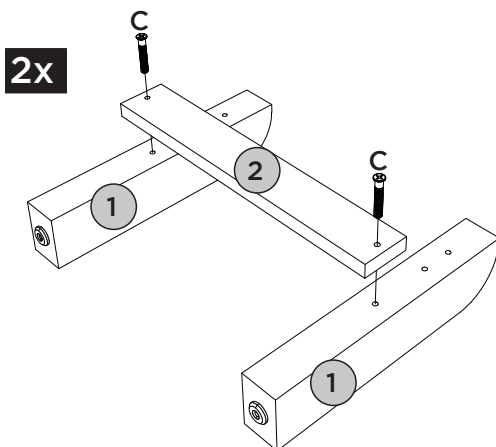
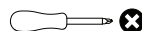

PASSO 4

PEÇAS REQUERIDAS

3	TRAVESSA MAIOR	x2
4	TRAVESSA	x1

ACESSÓRIOS REQUERIDOS





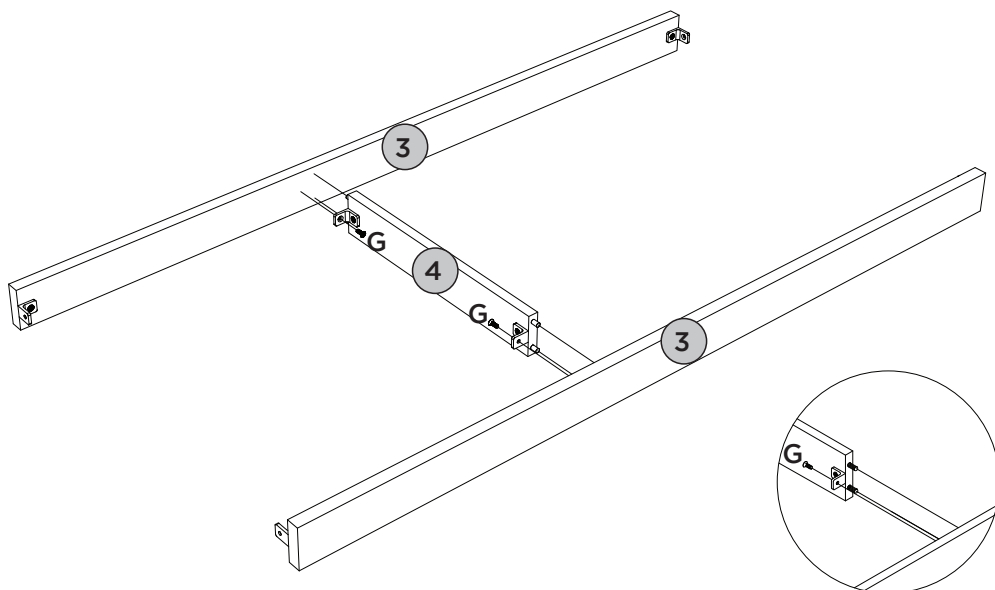
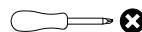

FERRAMENTAS NECESSÁRIAS



PASSO 5**PEÇAS REQUERIDAS**

5	PÉ CENTRAL	x1
---	------------	----

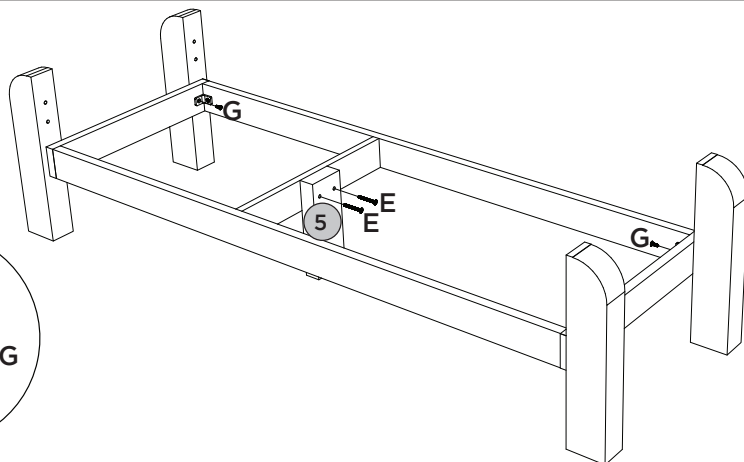
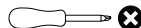

ACESSÓRIOS REQUERIDOS

E			02
G			04

FERRAMENTAS NECESSÁRIAS**PASSO 6****PEÇAS REQUERIDAS**

6	BASE	x1
7	LATERAL ESQUERDA	x1
8	PRATELEIRA	x1
9	DIVISÃO	x1

ACESSÓRIOS REQUERIDOS

B			05
---	---	---	----

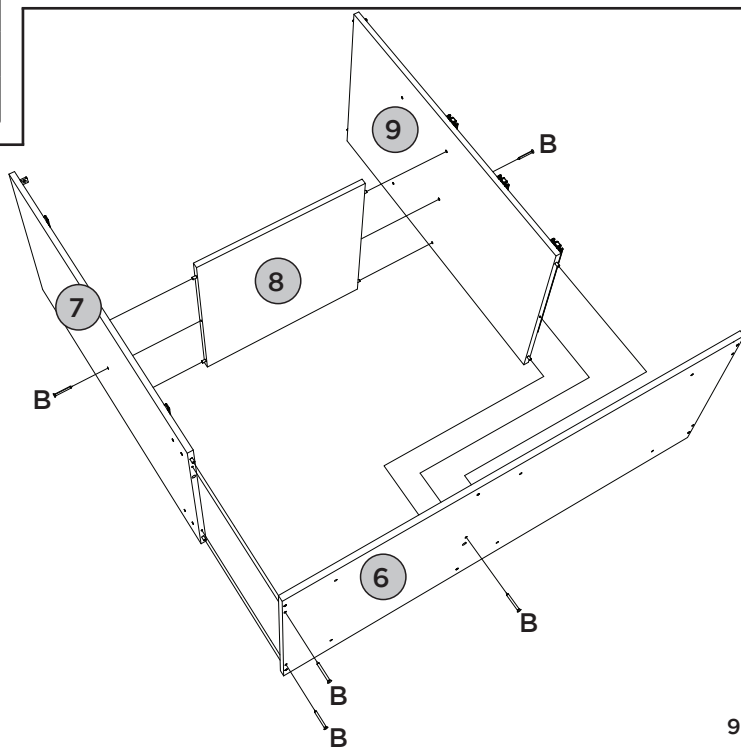
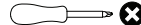
FERRAMENTAS NECESSÁRIAS

PASSO 7

ITM/1725-

PEÇAS REQUERIDAS

6	TAMPO DAS GAVETAS	x1
7	LATERAL DIREITA	x1

ACESSÓRIOS REQUERIDOS



FERRAMENTAS NECESSÁRIAS

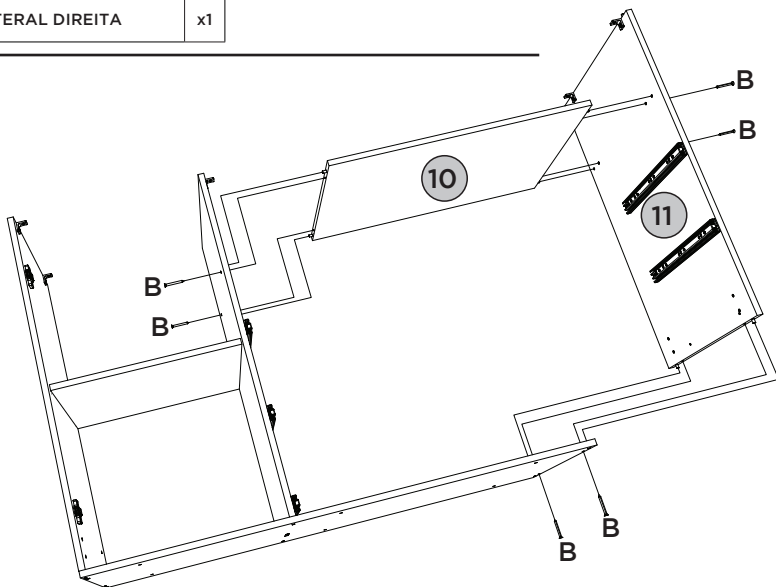
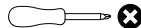

PASSO 8

PEÇAS REQUERIDAS

12	TAMPO	x1
----	-------	----

ACESSÓRIOS REQUERIDOS

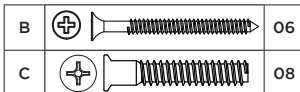

FERRAMENTAS NECESSÁRIAS

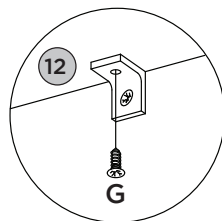
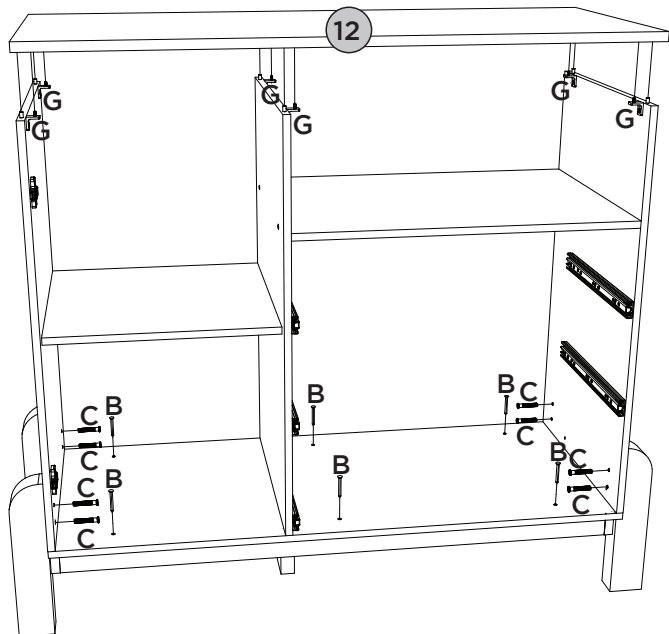
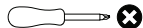



PASSO 9

ITM/1725-

PEÇAS REQUERIDAS

13	FUNDO MAIOR	x1
14	FUNDO MENOR	x1
15	FUNDO CRU	x2

ACESSÓRIOS REQUERIDOS

J		45
K		11
U		01

FERRAMENTAS NECESSÁRIAS

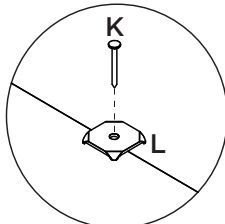
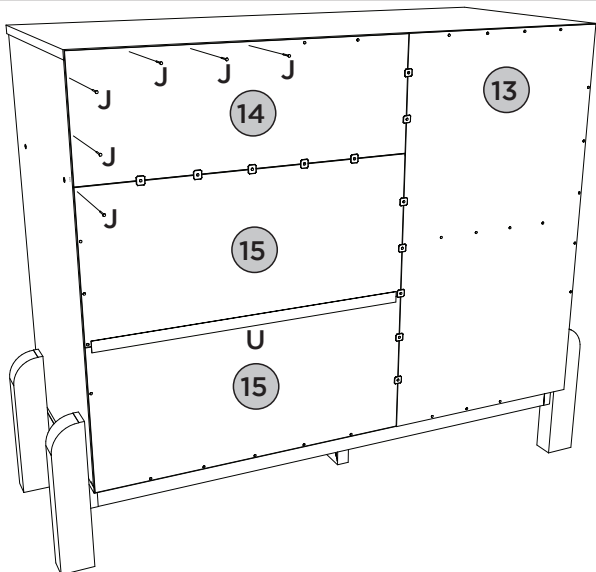





PASSO 10

PEÇAS REQUERIDAS

16	PORTA	x1
----	-------	----

ACESSÓRIOS REQUERIDOS

D		01
G		04
Q		01
S		02

FERRAMENTAS NECESSÁRIAS

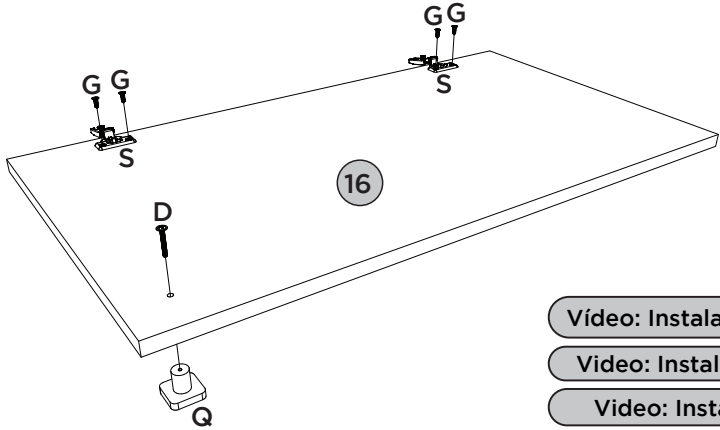
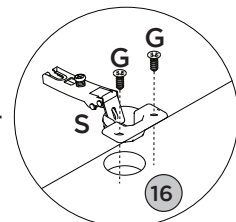
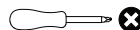



- Vídeo: Instalar e regular Dobradiças
- Vídeo: Instale y ajuste las bisagras
- Vídeo: Install and adjust hinges

PASSO 11

PEÇAS REQUERIDAS

16	PORTA	x1
----	-------	----

ACESSÓRIOS REQUERIDOS

G		03
T		01

FERRAMENTAS NECESSÁRIAS

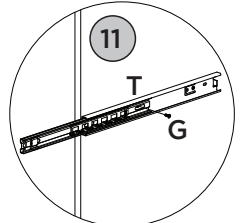
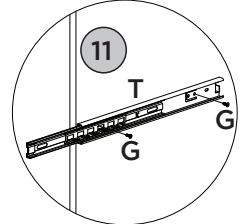
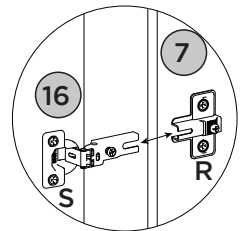
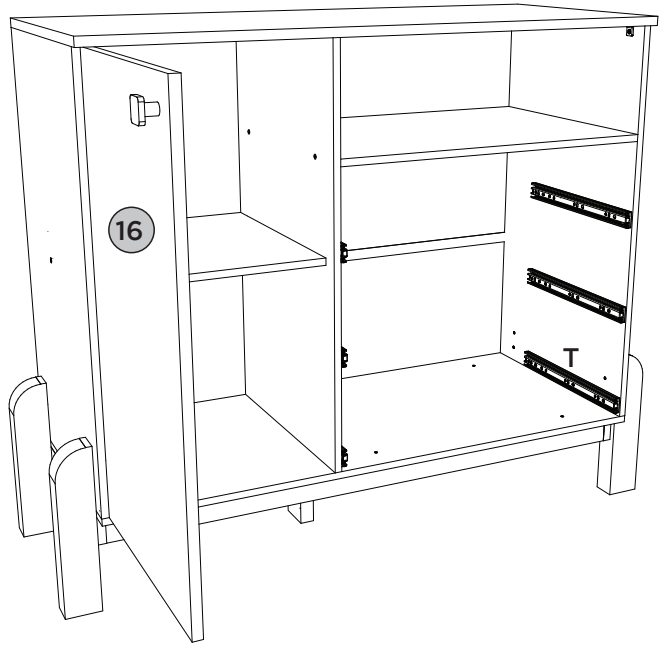
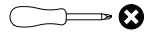



PASSO 12

PEÇAS REQUERIDAS

18	LADO DE GAVETA	x6
----	----------------	----

ACESSÓRIOS REQUERIDOS

H		24
V		

FERRAMENTAS NECESSÁRIAS



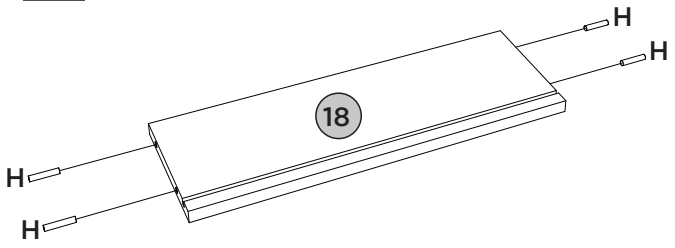

6x



PEÇAS REQUERIDAS

17	FRENTE DE GAVETA	x3
18	LADO DE GAVETA	x6
19	FUNDO DE GAVETA	x3

ACESSÓRIOS REQUERIDOS

G		12
M		06
V		

FERRAMENTAS NECESSÁRIAS

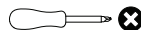
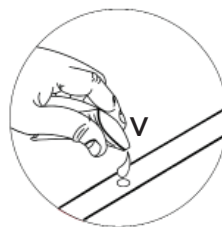
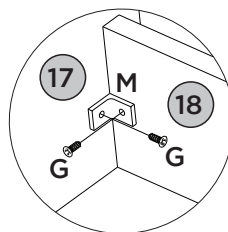
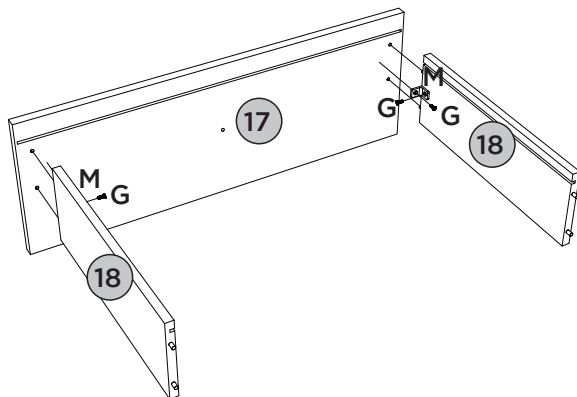
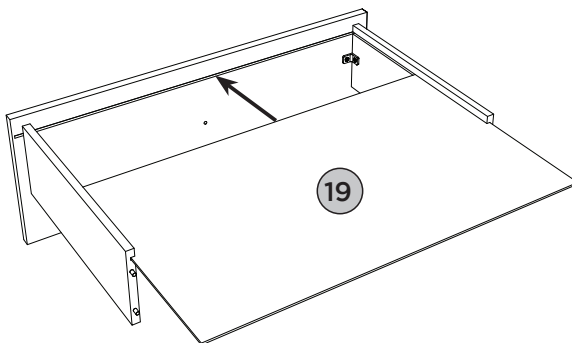
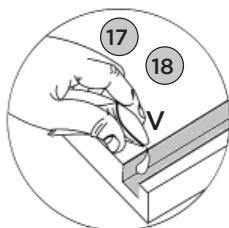
3x
1º

3x
2º

PEÇAS REQUERIDAS

20	RIPA DE TRÁS	x3
----	--------------	----

ACESSÓRIOS REQUERIDOS

D		03
F		06
G		18
I		06
N		06

FERRAMENTAS NECESSÁRIAS

	Q	03
	T	03
	V	

3x
3º

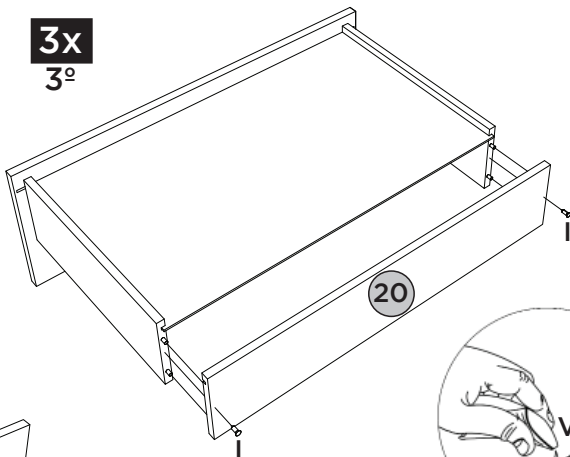

3x
4º

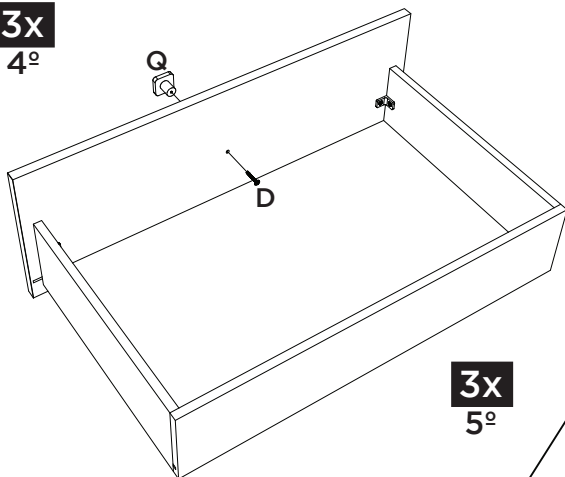

Deixar 3mm de distância da frente de gaveta.





Deje una separación de 3mm del frente del cajón.

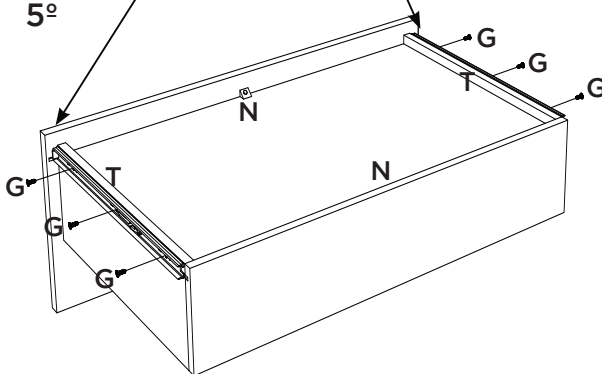

Leave 3mm away from the front of the drawer.

3x
5º



ACESSÓRIOS REQUERIDOS

A		01
G		02
O		01
P		01

W		08
X		03
Y	HENN	01

FERRAMENTAS NECESSÁRIAS

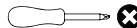

Imprescindível a fixação do produto na parede, a não colocação destas ferragens para fixação (A, G, O e P), poderá permitir que o produto vire, causando acidente.

Es imprescindible la fijación del producto en la pared, la no colocación de estos herrajes para fijación (A, G, O y P), podrá permitir que el El producto se vuelva, causando accidente.

Indispensable to fix the product on the wall, not the placement of these attachment fittings (A, G, O and P), may allow the product to turn, causing an accident.

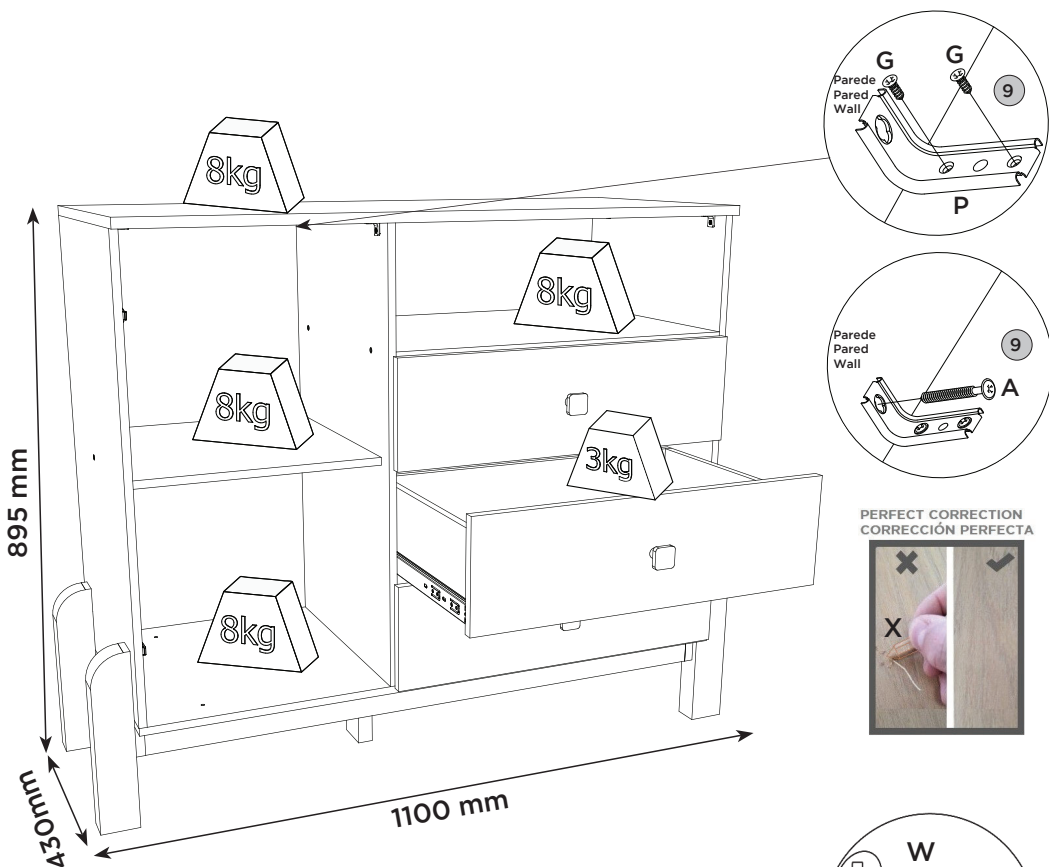

Pesos máximos recomendados com carga distribuída
 Peso máximo recomendado con la carga distribuída
 Recommended maximum weight with distributed load.

Produto Concluído
Producto terminado
Finished Product

