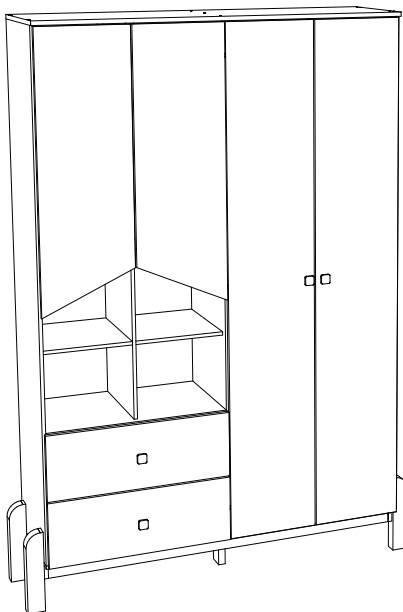
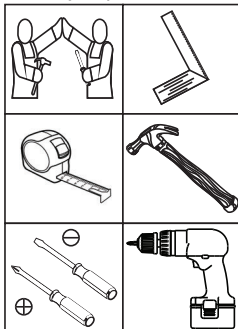

**HENN**Ind. e Com. de Móveis Henn  
Mondai - SC - Brasil

☎ +55 49 3674.3500

📱 @moveishenn  
www.henn.com.br**INSTRUÇÕES DE  
MONTAGEM**INSTRUCCIONES DE MONTAJE  
ASSEMBLY INSTRUCTIONS**Roupeiro Ternura 4 Portas | Armario Ternura 4 Puertas |  
Wardrobe Ternura 4 Doors**

I130-190 Branco/Jequitibá HP

**Requisitos para montagem  
Requisitos para la montaje  
Assembly Requirements**

Imagens meramente ilustrativas,  
não acompanha o produto.  
Imágenes ilustrativas, no incluidas  
con el producto.  
Illustrative images, not included  
with the product.

**AVISO**

Para limpeza de seu móvel, use uma flanela seca ou umedecida, e não utilize produtos químicos que possam danificar seu produto.

**SISTEMA DE MONTAGEM**

O sistema de montagem dos produtos, funciona de acordo com a ordem crescente dos números indicados no desenho. Ex: 01, 02, 03, 04... até a conclusão da montagem.

**ASSISTÊNCIA TÉCNICA**

Para solicitação de Assistência Técnica você consumidor deverá entrar em contato com o Lojista o qual você realizou a compra deste produto e solicitar a assistência técnica das peças avariadas. A garantia abrange todas as peças, partes e componentes que eventualmente venham apresentar defeito de fabricação no prazo de 03 (três) meses, contando a partir da entrega do produto ao consumidor, mediante nota fiscal de compra. Se houver qualquer alteração na estrutura do produto ou ocorrer defeito por negligência do montador/consumidor em relação a instrução de montagem e manuseio, não será fornecido assistência técnica gratuita.

**ADVERTENCIA**

Para limpeza de su móvil, use una flanela seca o húmeda, y no utilice productos químicos que puedan dañar su producto.

**SISTEMA DE MONTAJE**

El sistema de montaje de los productos funciona de acuerdo con el orden creciente de los números indicados en el dibujo. Ej.: 01, 02, 03, 04... hasta la conclusión del montaje.

**ASISTENCIA TÉCNICA**

Para solicitar Asistencia Técnica, el consumidor debe comunicarse con el Comercio que usted realizó la compra de este producto y solicita asistencia técnica para las partes dañadas. La garantía cubre todas las partes, piezas y componentes que eventualmente puedan presentar defecto de fabricación en el plazo de 03 (tres) meses, contados a partir de la entrega del producto al consumidor, mediante factura de compra. Si se produce algún cambio en la estructura del producto o se produce un defecto por negligencia del montador/consumidor en relación con las instrucciones de montaje y manipulación, no se prestará asistencia técnica gratuita.

**NOTICE**

To clean your furniture, use a dry or wet cloth, and do not use chemicals that may damage your product.

**ASSEMBLY SYSTEM**

The products' assembly system works according to the increasing order of the indicated numbers. For example: 01, 02, 03, 04 ... to the end of the assembly.

**TECHNICAL ASSISTANCE**

To request Technical Assistance, the consumer must contact the retailer from whom you purchased this product and request technical assistance for the damaged parts. The warranty covers all parts, parts and components that may eventually present a manufacturing defect within a period of 03 (three) months, counting from the delivery of the product to the consumer, by means of a purchase invoice. If there is any change in the structure of the product or defect occurs due to negligence of the assembler/consumer in relation to the assembly and handling instruction, free technical assistance will not be provided.

# ACESSÓRIOS | ACCESORIOS | ACCESSORIES

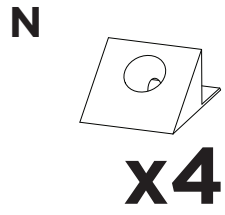
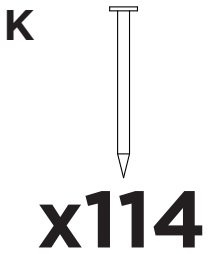
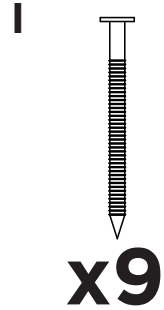
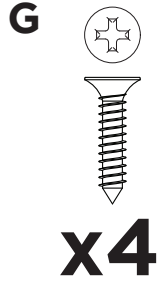
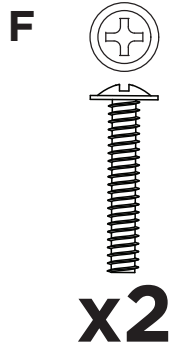
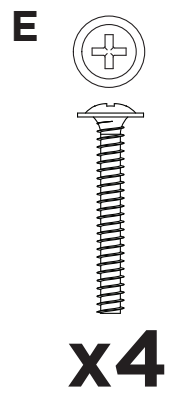
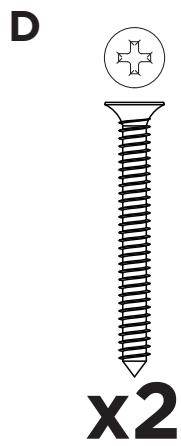
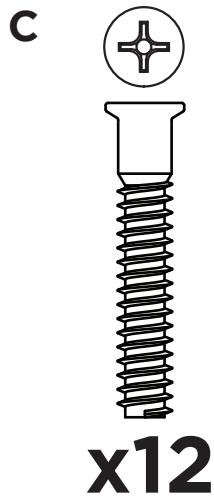
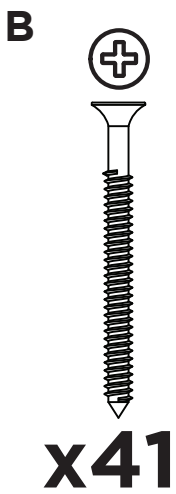
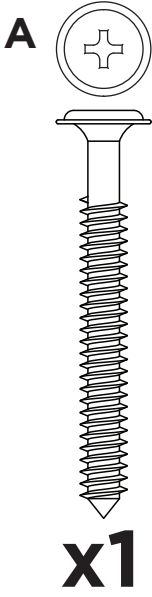

## ACESSÓRIOS | ACCESORIOS | ACCESSORIES

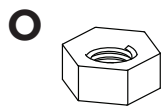

**x2**

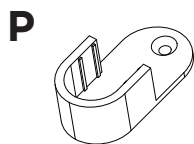

**x2**

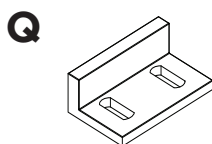

**x2**

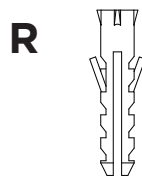

**x1**

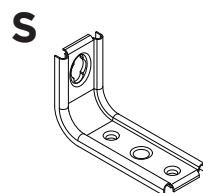

**x1**



**x4**

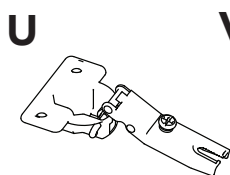

**x10**

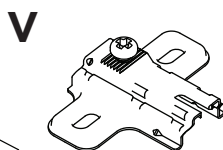

**x10**



**x5**



**x2 PAR**



**x1**



**x1**



**x1**

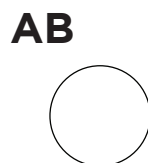

**x26**

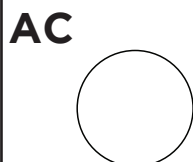

**x4**

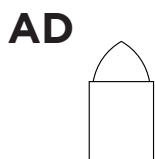

**x3**



**x1**



HENN

**x1**



**x4**

Parafusos em escala  
Tornillos escalados  
Scaled screws

1:1

# LISTA DE PEÇAS | LISTA DE PIEZAS | LIST OF PIECES

Item	Caixa Caja Box	Qty Ctd Qty	Descrição Descripción Description	Dimensões (mm)   Dimensiones (mm)   Dimensions (mm)		
				Comprimento Largo Length	Largura Ancho Width	Espessura Grosor Thickness
1	1/2	04	PÉ   PIE   FOOT	280	60	40
2	2/2	02	TRAVESSA LATERAL   TRAVESAÑO LATERAL   SIDE TRAY	301	50	15
3	2/2	02	TRAVESSA MAIOR   TRAVESAÑO MÁS GRANDE   BIGGER TRAY	1270	50	15
4	2/2	01	TRAVESSA   TRAVESAÑO   TRAY	270	50	12
5	1/2	01	PÉ CENTRAL   PIE CENTRAL   CENTER FOOT	160	60	25
6	1/2	01	LATERAL ESQUERDA   LADO IZQUIERDO   LEFT SIDE	1813	380	12
7	1/2	01	DIVISÃO   DIVISIÓN   DIVISION	1813	380	12
8	1/2	01	TAMPO DAS GAVETAS   TAPA DE LOS CAJONES   TOP OF DRAWERS	632	380	12
9	1/2	01	DIVISÃO MENOR   DIVISIÓN MENOR   MINOR DIVISION	540	351	12
10	1/2	02	PRATELEIRA MENOR   ESTANTE MENOR   MINOR SHELF	350	310	12
11	1/2	01	PRATELEIRA SUPERIOR   ESTANTE SUPERIOR   TOP SHELF	632	380	12
12	1/2	01	BASE   BASE   BASE	1300	380	12
13	1/2	01	LATERAL DIREITA   LADO DERECHO   RIGHT SIDE	1813	380	12
14	1/2	04	PRATELEIRA   ESTANTE   SHELF	632	350	12
15	1/2	01	TAMPO   TAPA   TOP	1301	397	15
16	2/2	02	FUNDO EXTERNO   FONDO EXTERNO   EXTERNAL BOTTOM	1018	323	3
17	2/2	02	FUNDO SUPERIOR   FONDO MÁS ALTO   TOP BOTTOM	819	323	3
18	1/2	02	FUNDO MAIOR   FONDO MÁS GRANDE   BIGGER BOTTOM	1838	323	3
19	2/2	01	PORTA ESQUERDA   PUERTA IZQUIERDA   LEFT DOOR	955	319	15
20	2/2	01	PORTA DIREITA   PUERTA DERECHA   RIGHT DOOR	955	319	15
21	2/2	02	PORTA MAIOR   PUERTA MÁS GRANDE   BIGGER DOOR	1815	319	15
22	2/2	02	FRENTE DE GAVETA   FRENTE DEL CAJÓN   DRAWER FRONT	642	230	15
23	1/2	04	LADO DE GAVETA   LATERAL DEL CAJÓN   DRAWER SIDE	350	122	12
24	1/2	02	FUNDO DE GAVETA   FONDO DEL CAJÓN   DRAWER BOTTOM	594	361	3
25	1/2	02	RIPA DE TRÁS   TRAVESAÑO TRASERO   REAR CLAPBOARD	607	122	12



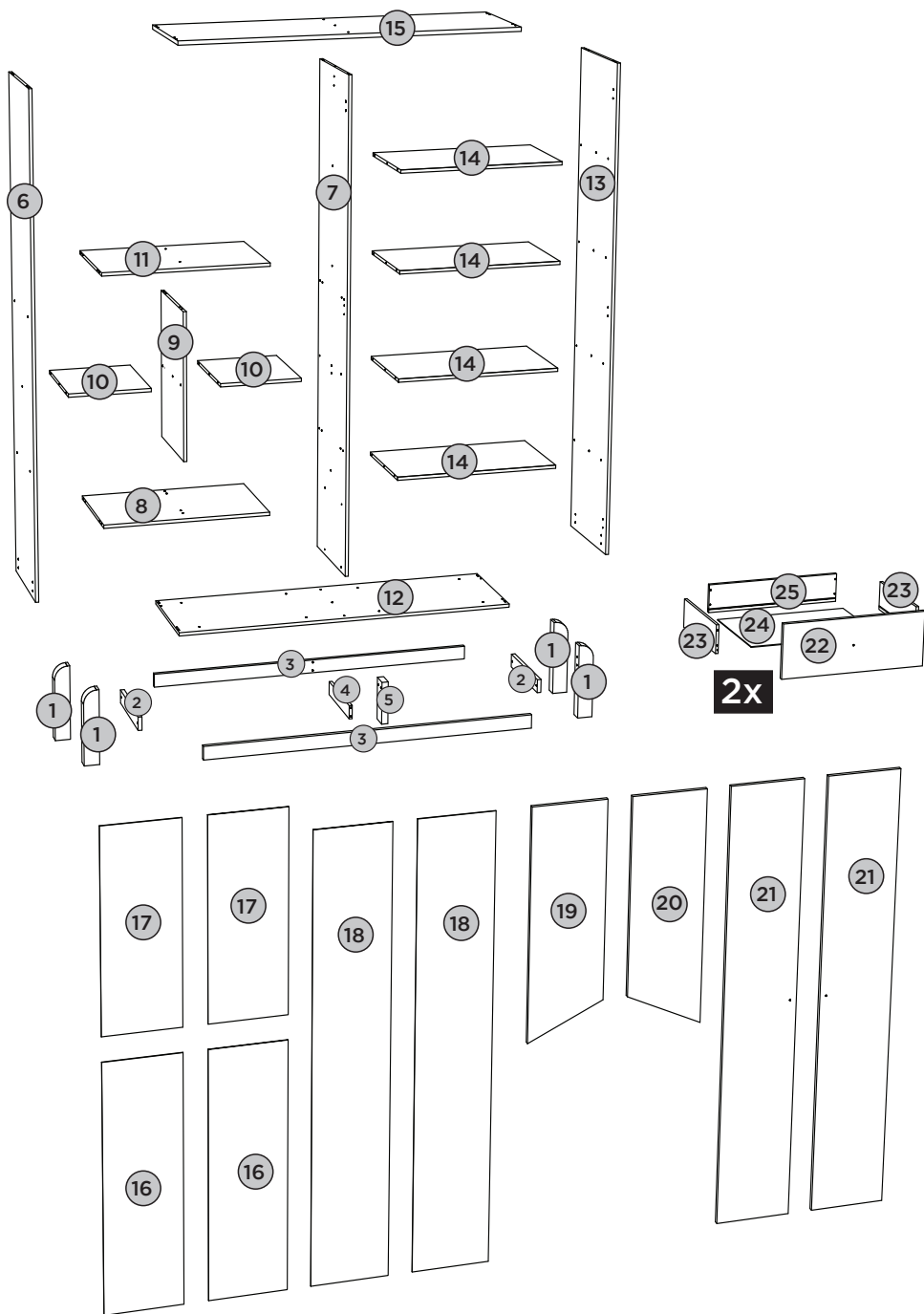

# LISTA DE PEÇAS | LISTA DE PIEZAS | LIST OF PIECES



## PEÇAS REQUERIDAS

1	PÉ	x4
3	TRAVESSA MAIOR	x2
4	TRAVESSA	x1
5	PÉ CENTRAL	x1

## ACESSÓRIOS REQUERIDOS

H		06
I		05
J		04
M		06
W		05



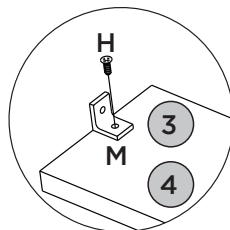
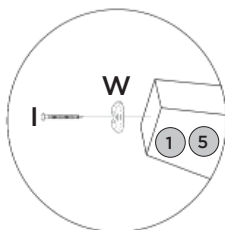
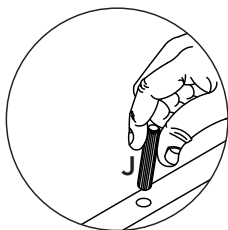
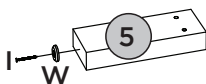
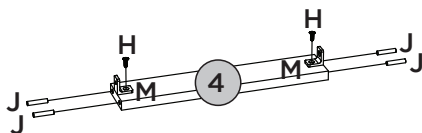
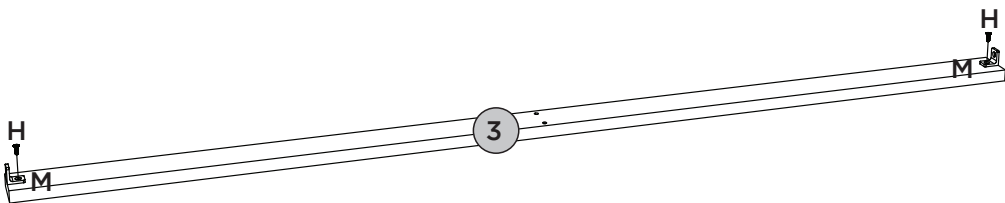
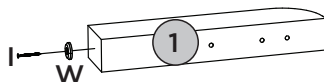
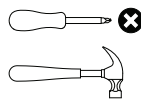

## FERRAMENTAS NECESSÁRIAS



## PEÇAS REQUERIDAS

6	LATERAL ESQUERDA	x1
7	DIVISÃO	x1
13	LATERAL DIREITA	x1

## ACESSÓRIOS REQUERIDOS

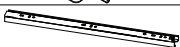
H		29
J		12
P		02
V		08
X		02

## FERRAMENTAS NECESSÁRIAS

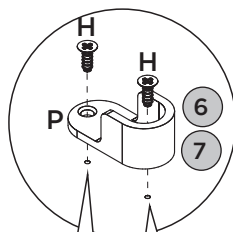
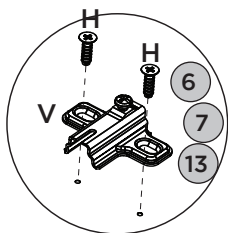
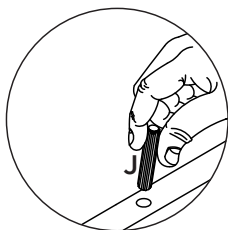
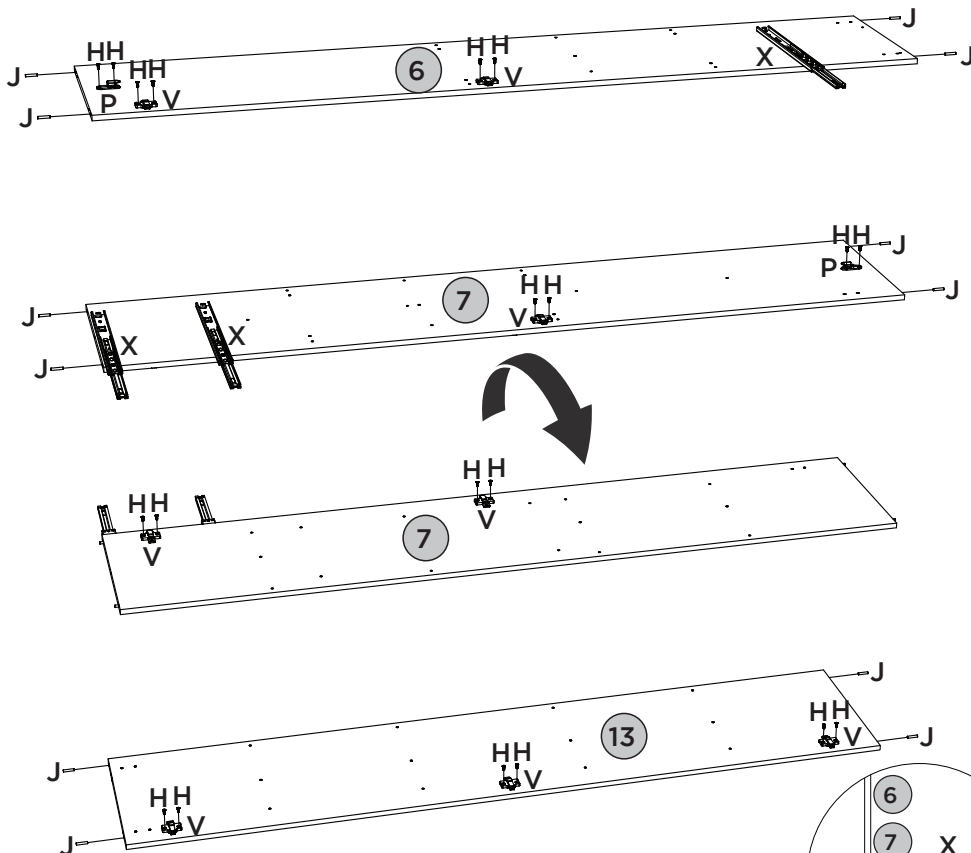
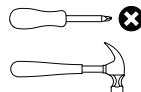

**Observe:  
Furos  
pré-marcados**

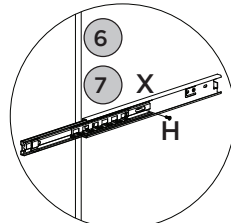
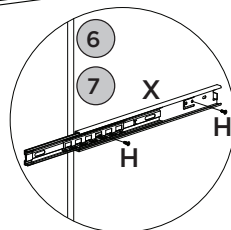

## PEÇAS REQUERIDAS

8	TAMPO DAS GAVETAS	x1
9	DIVISÃO MENOR	x1
10	PRATELEIRA MENOR	x2
11	PRATELEIRA EXTERNA	x1
14	PRATELEIRA	x4

## ACESSÓRIOS REQUERIDOS

J		36
---	---	----

## FERRAMENTAS NECESSÁRIAS

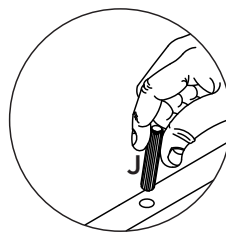
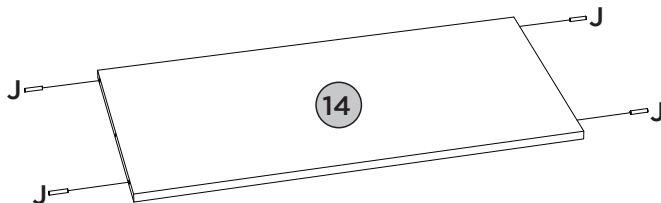
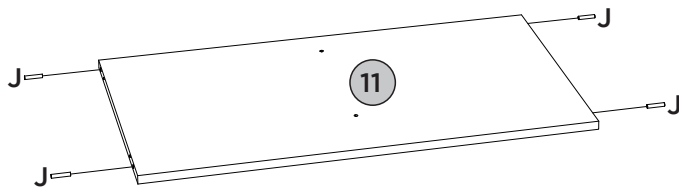
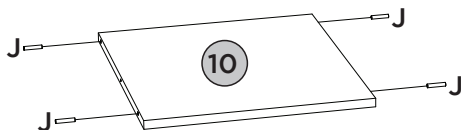
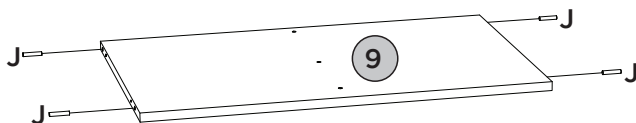
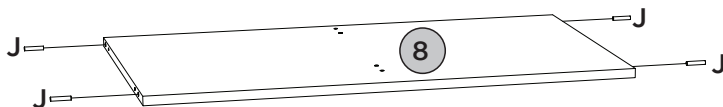
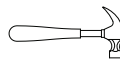

# PASSO 4

ITM/I130-

## PEÇAS REQUERIDAS

1	PÉ	x4
2	TRAVESSA LATERAL	x2

## ACESSÓRIOS REQUERIDOS

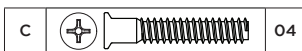

## FERRAMENTAS NECESSÁRIAS

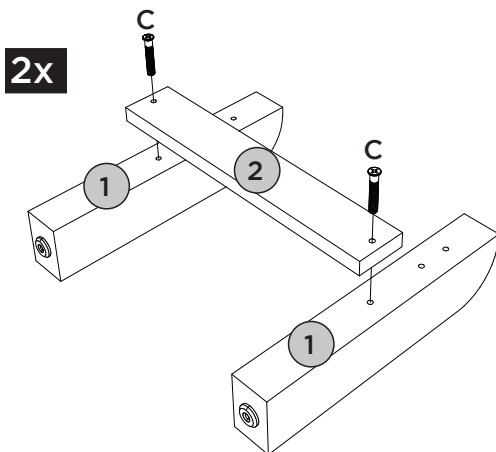
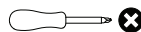

# PASSO 5

## PEÇAS REQUERIDAS

3	TRAVESSA MAIOR	x2
4	TRAVESSA	x1

## ACESSÓRIOS REQUERIDOS





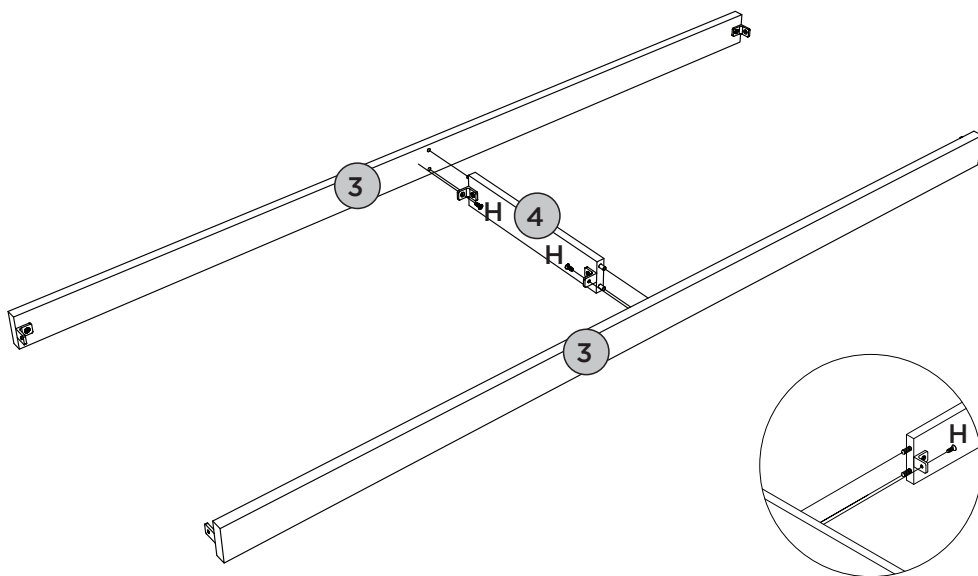
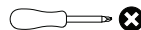

## FERRAMENTAS NECESSÁRIAS



**PASSO 6****PEÇAS REQUERIDAS**

5	PÉ CENTRAL	x1
---	------------	----

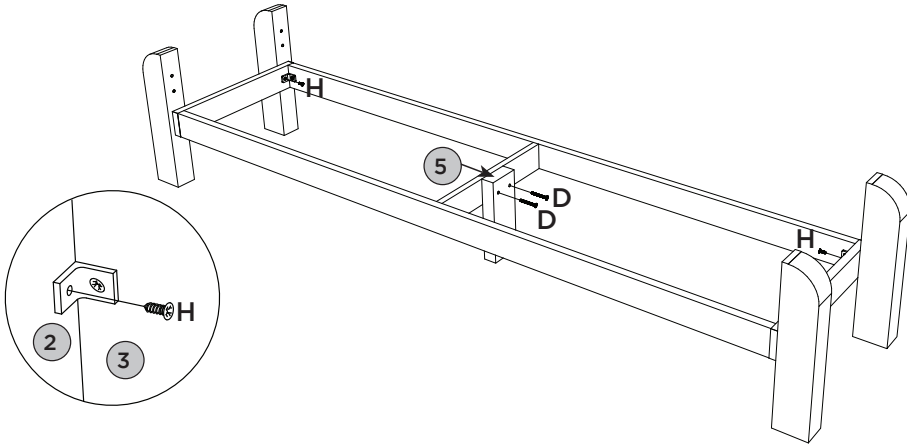
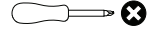

**ACESSÓRIOS REQUERIDOS**

D			02
H			04

**FERRAMENTAS NECESSÁRIAS****PASSO 7****PEÇAS REQUERIDAS**

8	TAMPO DAS GAVETAS	x1
9	DIVISÃO MENOR	x1
10	PRATELEIRA MENOR	x1
11	PRATELEIRA EXTERNA	x1

**ACESSÓRIOS REQUERIDOS**

B			05
---	---	---	----

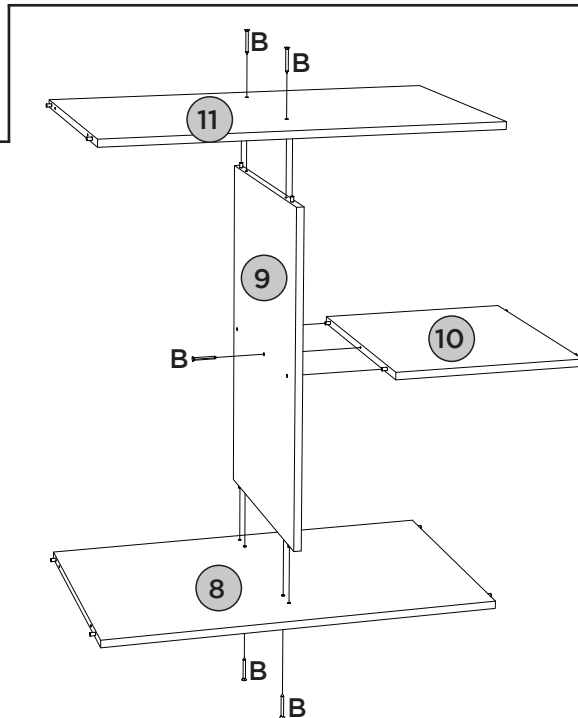
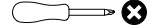
**FERRAMENTAS NECESSÁRIAS**

## PEÇAS REQUERIDAS

6	LATERAL ESQUERDA	x1
7	DIVISÃO	x1
10	PRATELEIRA MENOR	x1

## ACESSÓRIOS REQUERIDOS

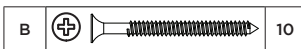

## FERRAMENTAS NECESSÁRIAS

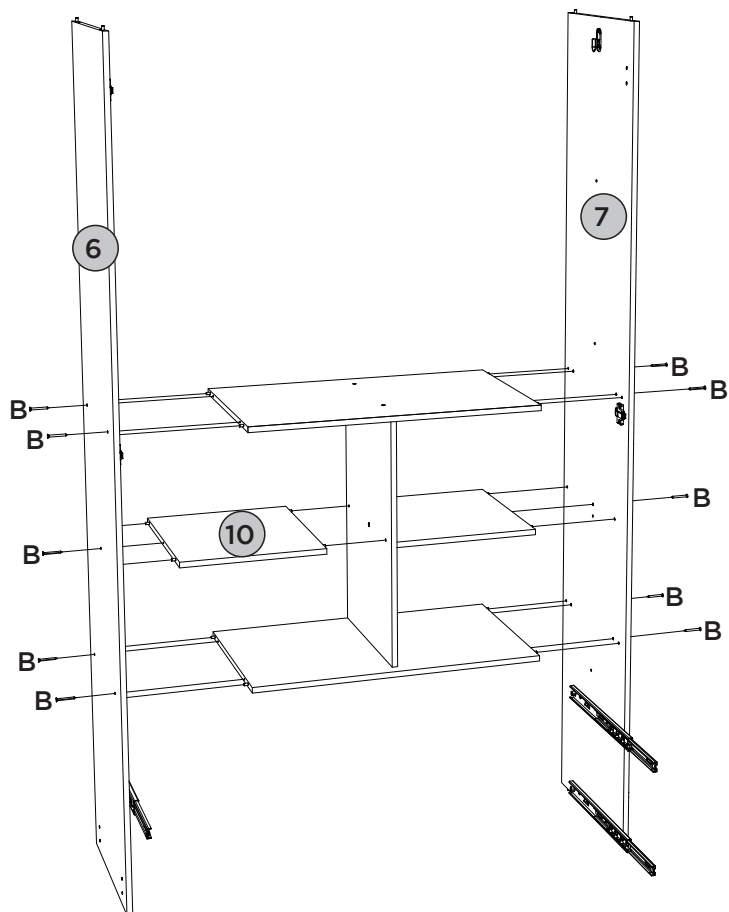
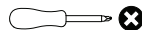

# PASSO 9

ITM/1130-

## PEÇAS REQUERIDAS

12	BASE	x1
13	LATERAL DIREITA	x1
14	PRATELEIRA	x4

## ACESSÓRIOS REQUERIDOS



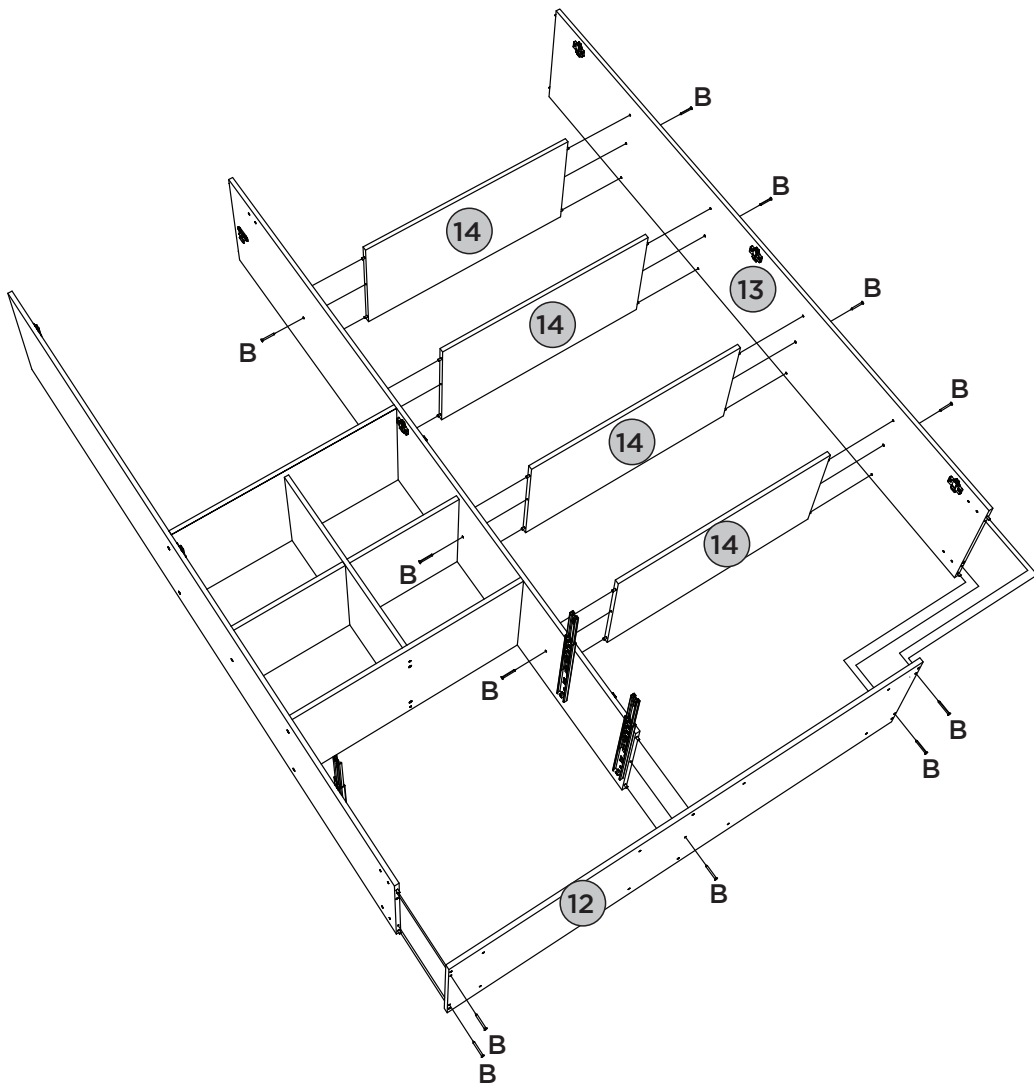
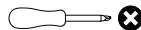

## FERRAMENTAS NECESSÁRIAS



## PEÇAS REQUERIDAS

15	TAMPO	x1
----	-------	----

## ACESSÓRIOS REQUERIDOS

B		13
C		08



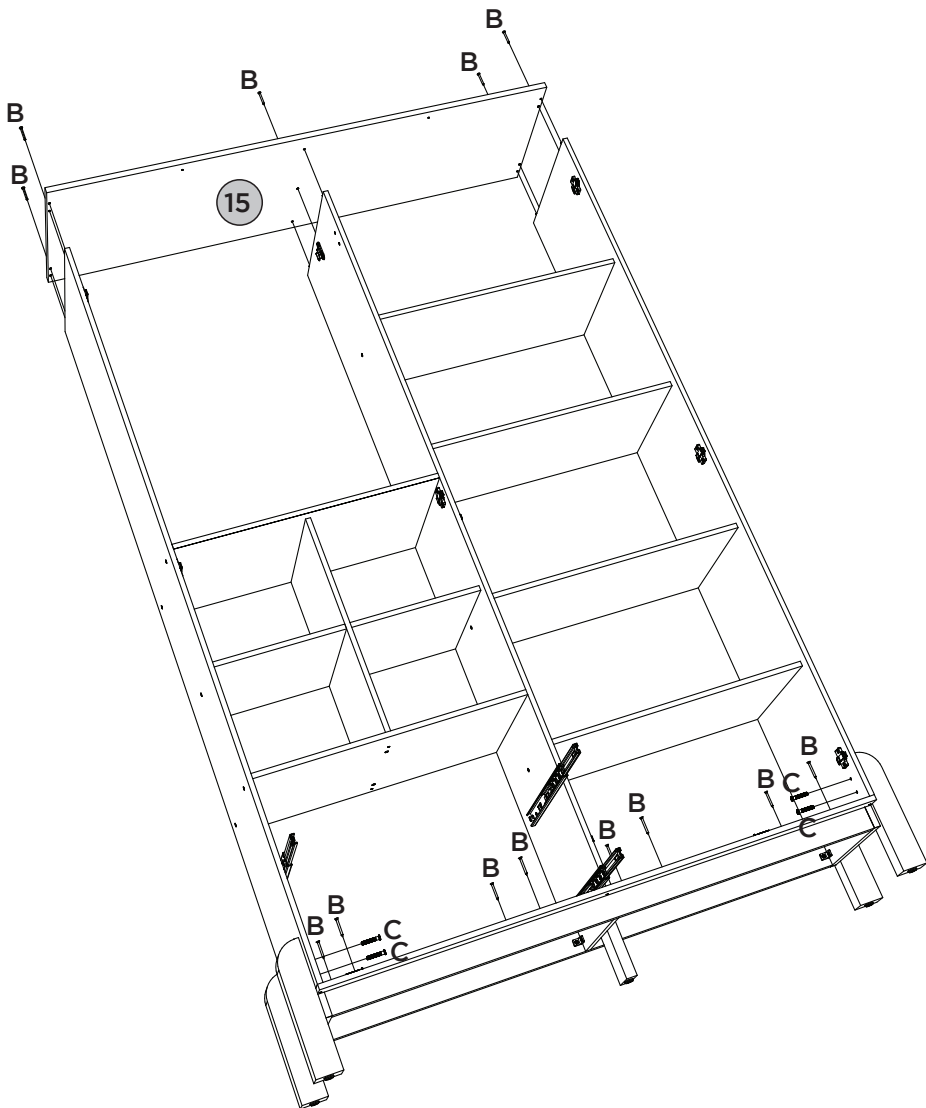
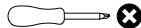

## FERRAMENTAS NECESSÁRIAS



## PEÇAS REQUERIDAS

16	FUNDO EXTERNO	x2
17	FUNDO SUPERIOR	x2
18	FUNDO MAIOR	x2

## ACESSÓRIOS REQUERIDOS

K		114
L		24
Y		01
Z		01



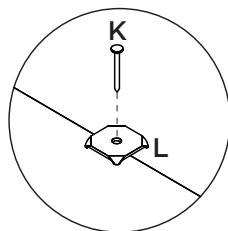
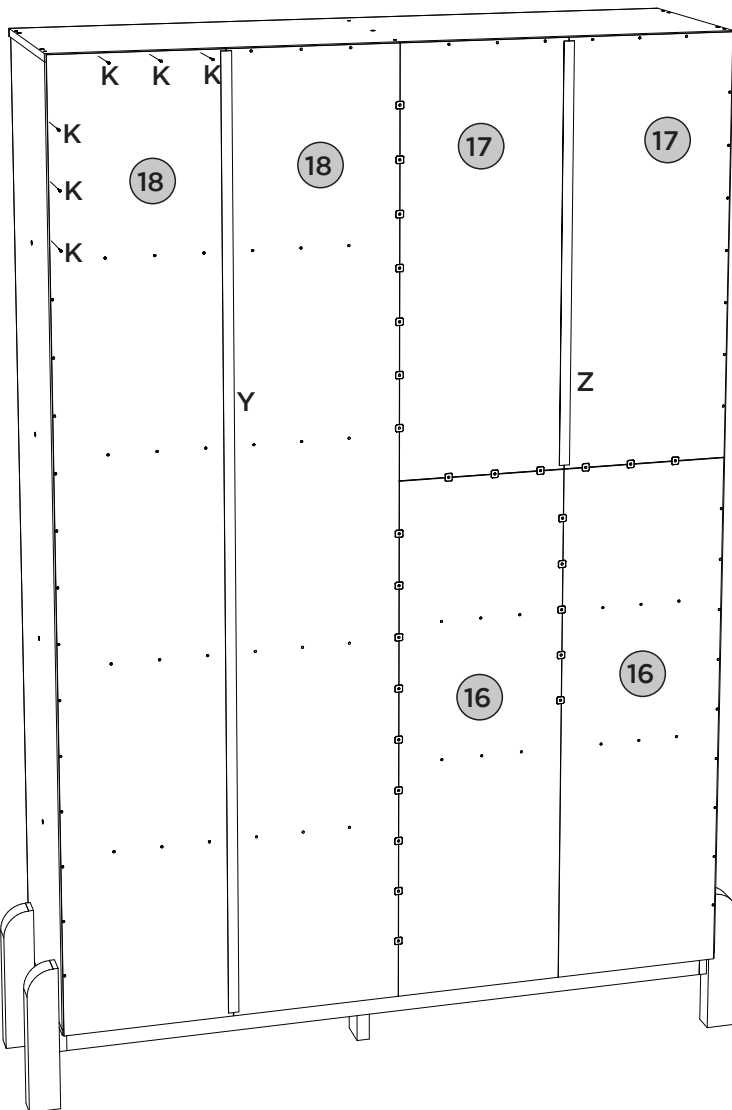
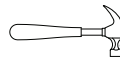

## FERRAMENTAS NECESSÁRIAS



## PEÇAS REQUERIDAS

19	PORTA ESQUERDA	x1
20	PORTA DIREITA	x1
21	PORTA MAIOR	x2

## ACESSÓRIOS REQUERIDOS

E		02
H		20
T		02
U		10

## FERRAMENTAS NECESSÁRIAS

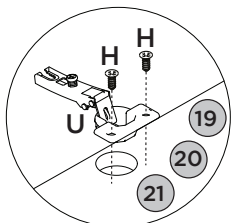
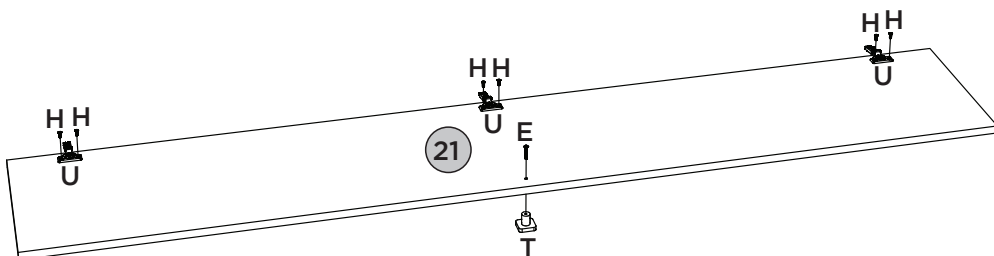
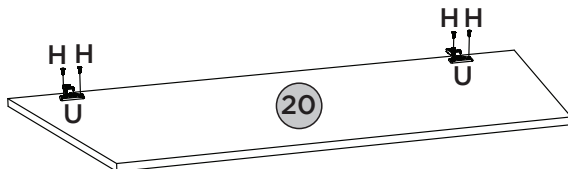
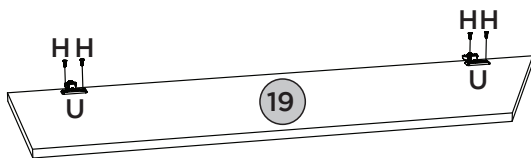
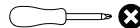

Vídeo: Instalar e regular Dobradiças







Vídeo: Instale y ajuste las bisagras

Video: Install and adjust hinges

## PEÇAS REQUERIDAS

19	PORTA ESQUERDA	x1
20	PORTA DIREITA	x1
21	PORTA MAIOR	x2

## ACESSÓRIOS REQUERIDOS

F		02
H		03
O		02
Q		02
V		02
X		01
AA		01

## FERRAMENTAS NECESSÁRIAS

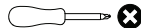

AG		04
----	---	----

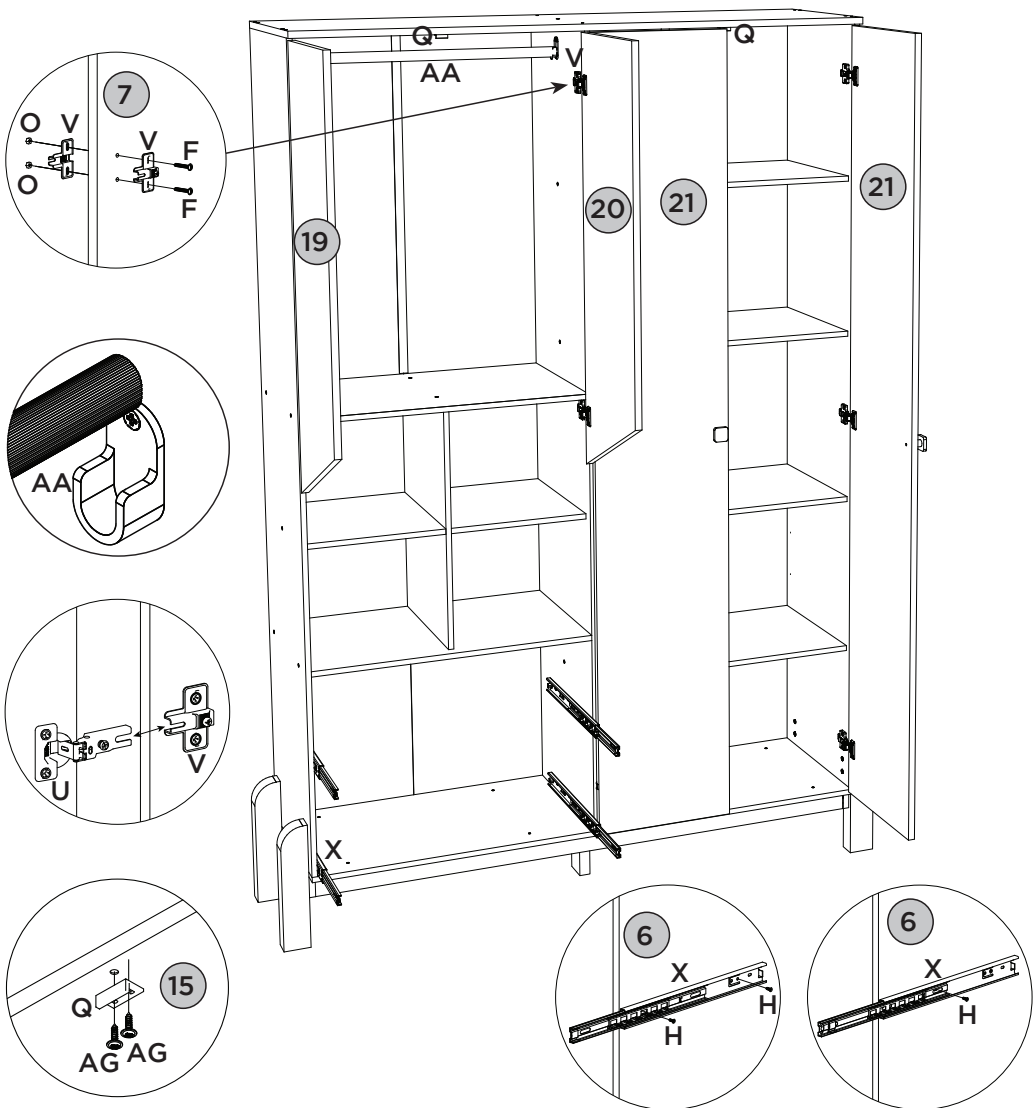



# PASSO 14

## PEÇAS REQUERIDAS

23	LADO DE GAVETA	x4
----	----------------	----

## ACESSÓRIOS REQUERIDOS

J		16
AE		

## FERRAMENTAS NECESSÁRIAS

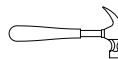

**4x**

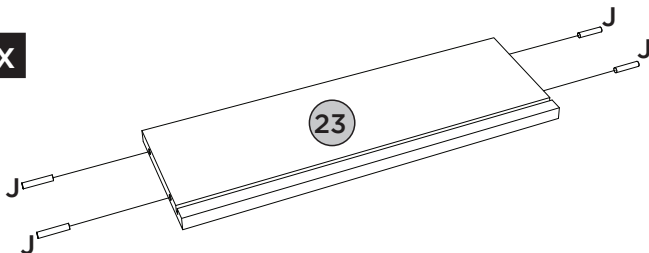



# PASSO 15

## PEÇAS REQUERIDAS

22	FRENTE DE GAVETA	x2
23	LADO DE GAVETA	x4
24	FUNDO DE GAVETA	x2

## ACESSÓRIOS REQUERIDOS

H		08
M		04
AE		

## FERRAMENTAS NECESSÁRIAS

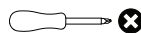

**2x**

1º

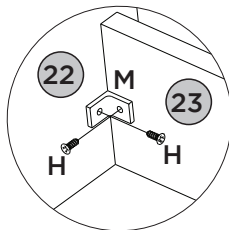
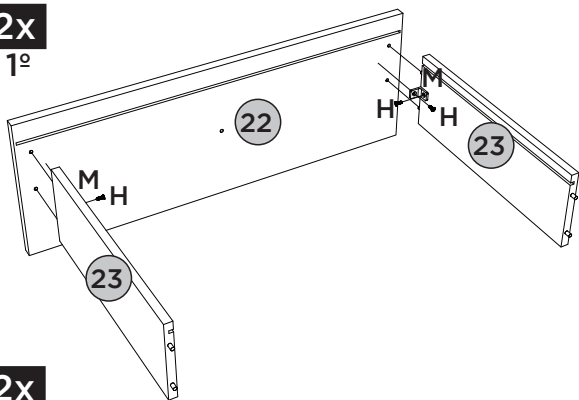

**2x**

2º

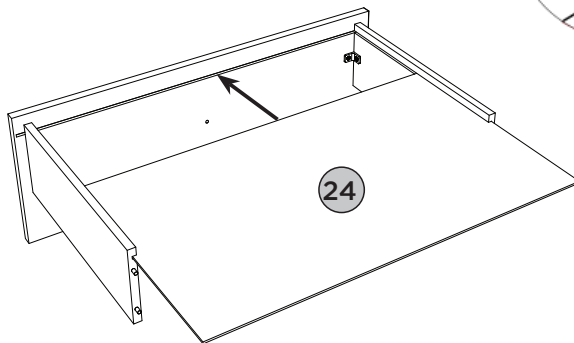
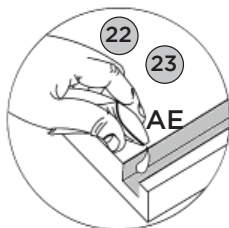

## PEÇAS REQUERIDAS

25	RIPA DE TRÁS	x2
----	--------------	----

## ACESSÓRIOS REQUERIDOS

E		02
G		04
H		12
I		04
N		04

## FERRAMENTAS NECESSÁRIAS

		02
		02
		02

**2x**  
3º

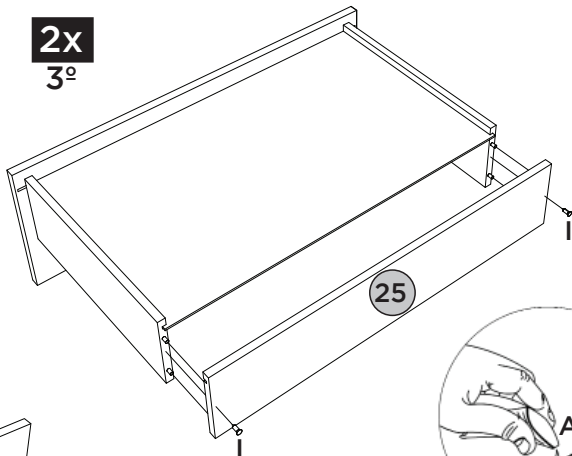

**2x**  
4º

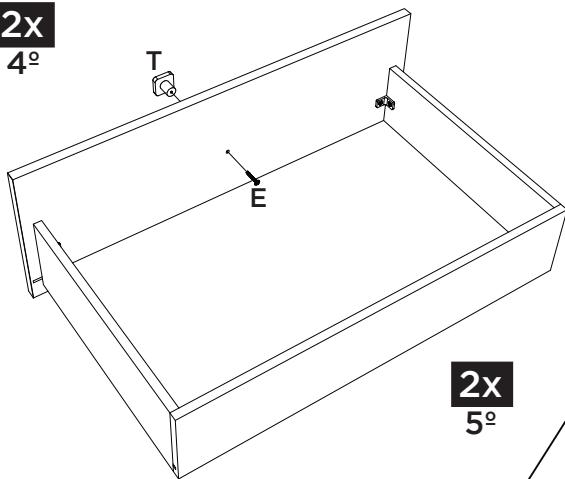

Deixar 3mm de distância da frente de gaveta.





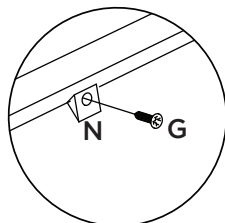
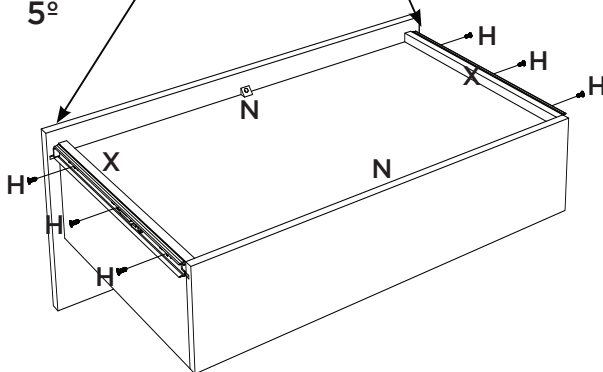

Deje una separación de 3mm del frente del cajón.

Leave 3mm away from the front of the drawer.

**2x**  
5º



ACESSÓRIOS REQUERIDOS

A		01	AB		26
H		02	AC		04
R		01	AD		03
S		01	AF	<b>HENN</b>	01

FERRAMENTAS NECESSÁRIAS

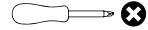

Imprescindível a fixação do produto na parede, a não colocação destas ferragens para fixação (A, H, R, e S), poderá permitir que o produto vire, causando acidente.

Es imprescindible la fijación del producto en la pared, la no colocación de estos herrajes para fijación (A, H, R, y S), podrá permitir que el El producto se vuelve, causando accidente.

Indispensable to fix the product on the wall, not the placement of these attachment fittings (A, H, R and S) may allow the product to turn, causing an accident.

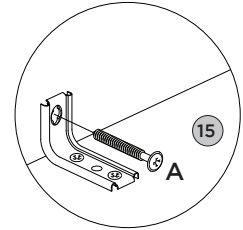
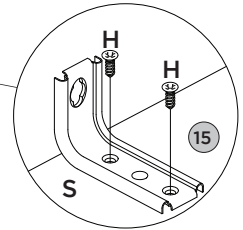
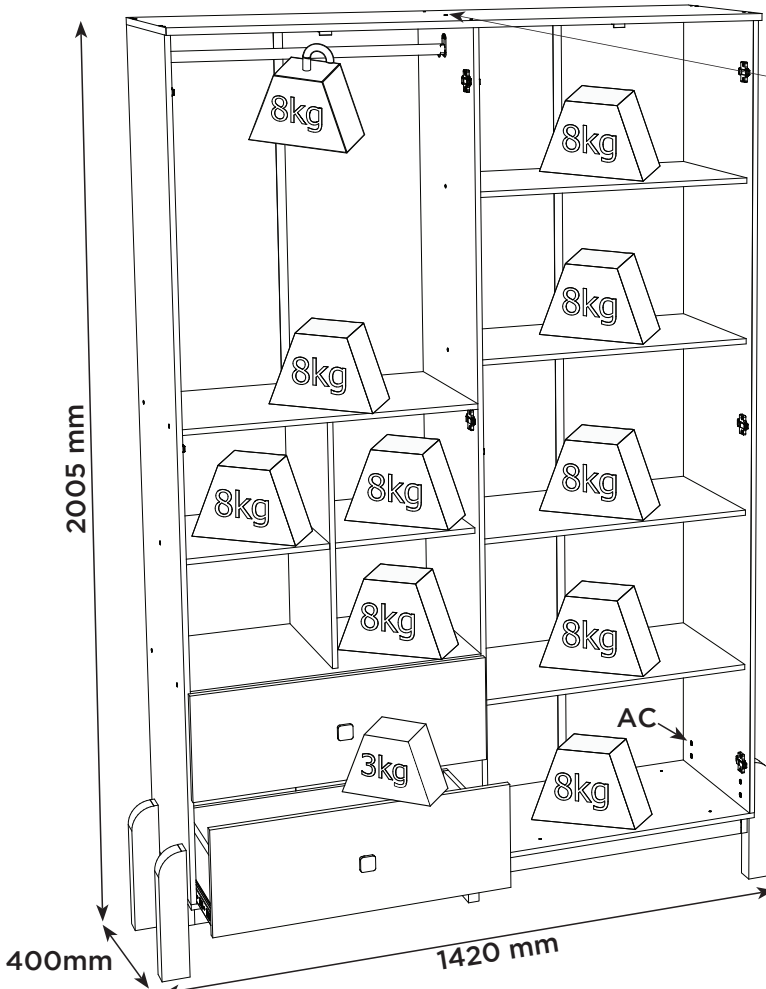

PERFECT CORRECTION  
CORRECCIÓN PERFECTA

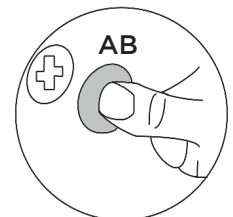
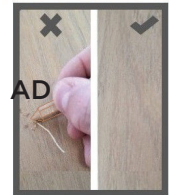

Pesos máximos recomendados com carga distribuída  
Peso máximo recomendado con la carga distribuida  
Recommended maximum weight with distributed load.

**Produto Concluído**  
**Producto terminado**  
**Finished Product**

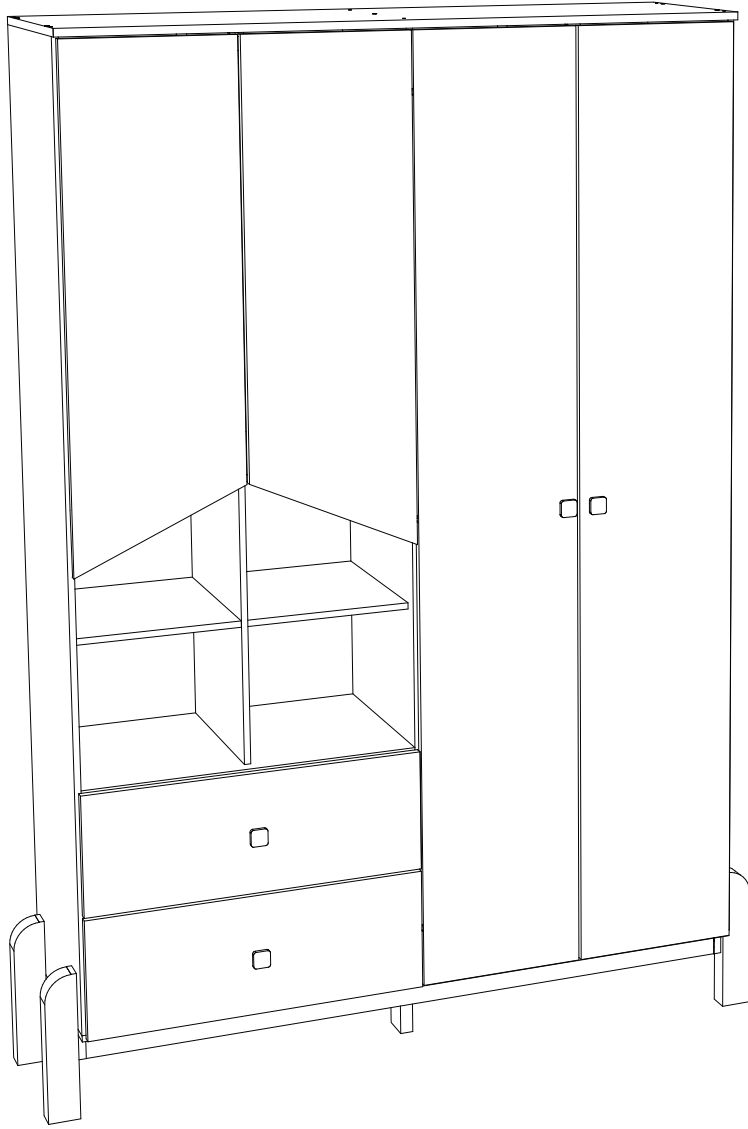

**HENN**Ind. e Com. de Móveis Henn  
Mondaiá - SC - Brasil

☎ +55 49 3674.3500

📷 📺 @moveishenn  
www.henn.com.br**INSTRUÇÕES DE  
MONTAGEM**INSTRUCCIONES DE MONTAJE  
ASSEMBLY INSTRUCTIONS**Cômoda Ternura 1 Porta 3 Gavetas |**  
Cómoda Ternura 1 Puerta 3 Cajones | Tenderness Dresser 1 Door 3 Drawers

1725-190 Branco/Jequitibá HP

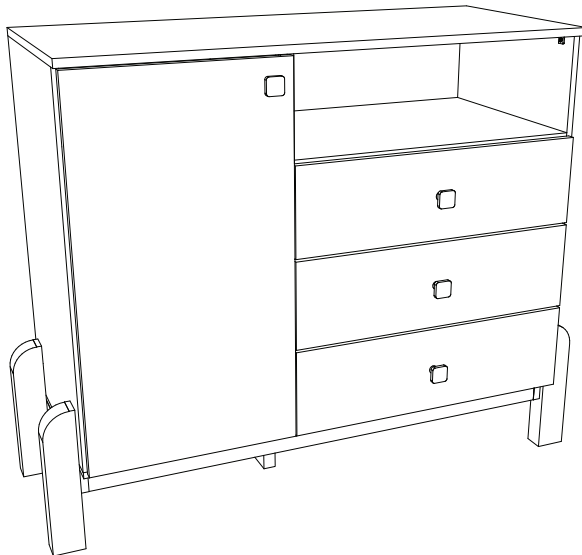
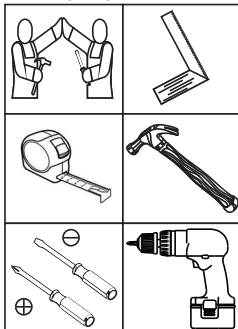
**Requisitos para montagem**  
Requisitos para la montaje  
Assembly Requirements

Imagens meramente ilustrativas,  
não acompanha o produto.  
Imágenes ilustrativas, no incluidas  
con el producto.  
Illustrative images, not included  
with the product.

**AVISO**

Para limpeza de seu móvel, use uma flanela seca ou umedecida, e não utilize produtos químicos que possam danificar seu produto.

**SISTEMA DE MONTAGEM**

O sistema de montagem dos produtos, funciona de acordo com a ordem crescente dos números indicados no desenho. Ex: 01, 02, 03, 04... até a conclusão da montagem.

**ASSISTÊNCIA TÉCNICA**

Para solicitação de Assistência Técnica você consumidor deverá entrar em contato com o Lojista o qual você realizou a compra deste produto e solicitar a assistência técnica das peças avariadas. A garantia abrange todas as peças, partes e componentes que eventualmente venham apresentar defeito de fabricação no prazo de 03 (três) meses, contando a partir da entrega do produto ao consumidor, mediante nota fiscal de compra. Se houver qualquer alteração na estrutura do produto ou ocorrer defeito por negligência do montador/consumidor em relação a instrução de montagem e manuseio, não será fornecido assistência técnica gratuita.

**ADVERTENCIA**

Para limpeza de su móvil, use una flanela seca o húmeda, y no utilice productos químicos que puedan dañar su producto.

**SISTEMA DE MONTAJE**

El sistema de montaje de los productos funciona de acuerdo con el orden creciente de los números indicados en el dibujo. Ej.: 01, 02, 03, 04... hasta la conclusión del montaje.

**ASISTENCIA TÉCNICA**

Para solicitar Asistencia Técnica, el consumidor debe comunicarse con el Comercio que usted realizó la compra de este producto y solicita asistencia técnica para las partes dañadas. La garantía cubre todas las partes, piezas y componentes que eventualmente puedan presentar defecto de fabricación en el plazo de 03 (tres) meses, contados a partir de la entrega del producto al consumidor, mediante factura de compra. Si se produce algún cambio en la estructura del producto o se produce un defecto por negligencia del montador/consumidor en relación con las instrucciones de montaje y manipulación, no se prestará asistencia técnica gratuita.

**NOTICE**

To clean your furniture, use a dry or wet cloth, and do not use chemicals that may damage your product.

**ASSEMBLY SYSTEM**

The products' assembly system works according to the increasing order of the indicated numbers. For example: 01, 02, 03, 04 ... to the end of the assembly.

**TECHNICAL ASSISTANCE**

To request Technical Assistance, the consumer must contact the retailer from whom you purchased this product and request technical assistance for the damaged parts. The warranty covers all parts, parts and components that may eventually present a manufacturing defect within a period of 03 (three) months, counting from the delivery of the product to the consumer, by means of a purchase invoice. If there is any change in the structure of the product or defect occurs due to negligence of the assembler/consumer in relation to the assembly and handling instruction, free technical assistance will not be provided.

## ACESSÓRIOS | ACCESORIOS | ACCESSORIES

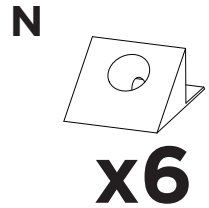
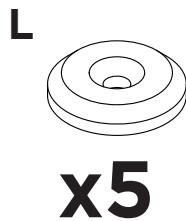
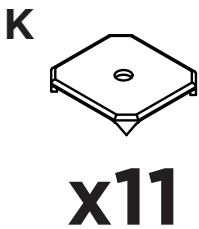
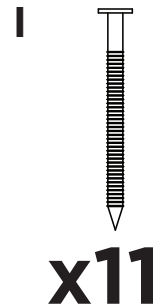
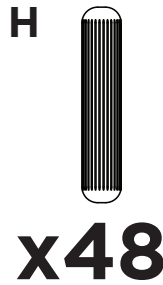
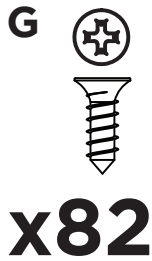
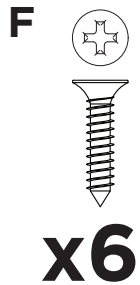
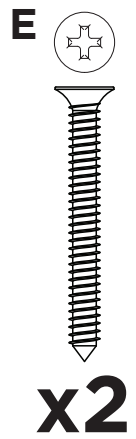
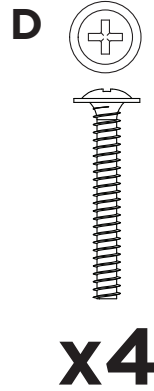
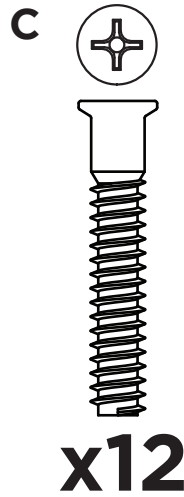
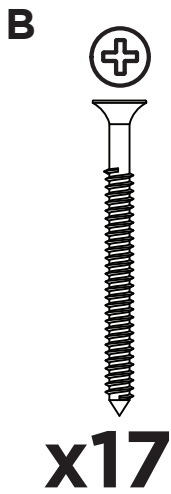
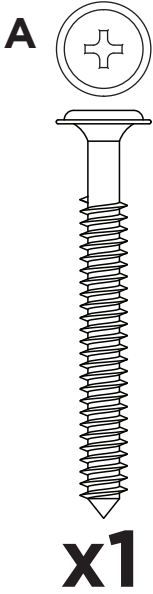

## ACESSÓRIOS | ACCESORIOS | ACCESSORIES

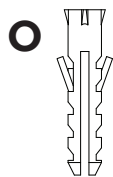

**x1**

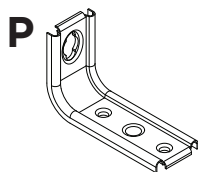

**x1**



**x4**

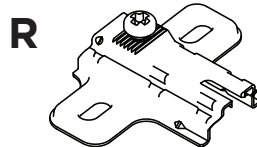

**x2**

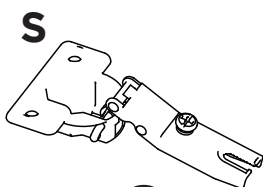

**x2**



**x3 PAR**



**x1**

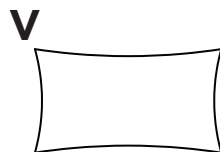

**x2**



**x8**

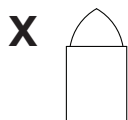

**x3**



HENN

**x1**

# LISTA DE PEÇAS | LISTA DE PIEZAS | LIST OF PIECES

Item	Caixa Caja Box	Qty Ctd Qty	Descrição Descripción Description	Dimensões (mm)   Dimensiones (mm)   Dimensions (mm)		
				Comprimento Largo Length	Largura Ancho Width	Espessura Grosor Thickness
1	1/1	04	PÉ   PIE   FOOT	280	60	40
2	1/1	02	TRAVESSA LATERAL   TRAVESAÑO LATERAL   SIDE TRAY	331	50	15
3	1/1	02	TRAVESSA MAIOR   TRAVESAÑO MÁS GRANDE   BIGGER TRAY	950	50	15
4	1/1	01	TRAVESSA   TRAVESAÑO   TRAY	300	50	12
5	1/1	01	PÉ CENTRAL   PIE CENTRAL   CENTER FOOT	160	60	25
6	1/1	01	BASE   BASE   BASE	980	410	12
7	1/1	01	LATERAL ESQUERDA   LADO IZQUIERDO   LEFT SIDE	704	410	12
8	1/1	01	PRATELEIRA   ESTANTE   SHELF	379	379	12
9	1/1	01	DIVISÃO   DIVISIÓN   DIVISION	704	410	12
10	1/1	01	TAMPO DAS GAVETAS   TAPA DE LOS CAJONES   TOP OF DRAWERS	565	410	12
11	1/1	01	LATERAL DIREITA   LADO DERECHO   RIGHT SIDE	704	410	12
12	1/1	01	TAMPO   TAPA   TOP	981	427	15
13	1/1	01	FUNDO MAIOR   FONDO MÁS GRANDE   BIGGER BOTTOM	729	395	3
14	1/1	01	FUNDO MENOR   FONDO MÁS PEQUEÑO   SMALLER BOTTOM	581	203	3
15	1/1	02	FUNDO CRU   FONDO CRUDO   RAW FUND	581	261	3
16	1/1	01	PORTA   PUERTA   DOOR	705	390	15
17	1/1	03	FRENTE DE GAVETA   FRENTE DEL CAJÓN   DRAWER FRONT	575	170	15
18	1/1	06	LADO DE GAVETA   LATERAL DEL CAJÓN   DRAWER SIDE	350	122	12
19	1/1	03	FUNDO DE GAVETA   FONDO DEL CAJÓN   DRAWER BOTTOM	527	361	3
20	1/1	03	RIPA DE TRÁS   TRAVESAÑO TRASERO   REAR CLAPBOARD	540	122	12



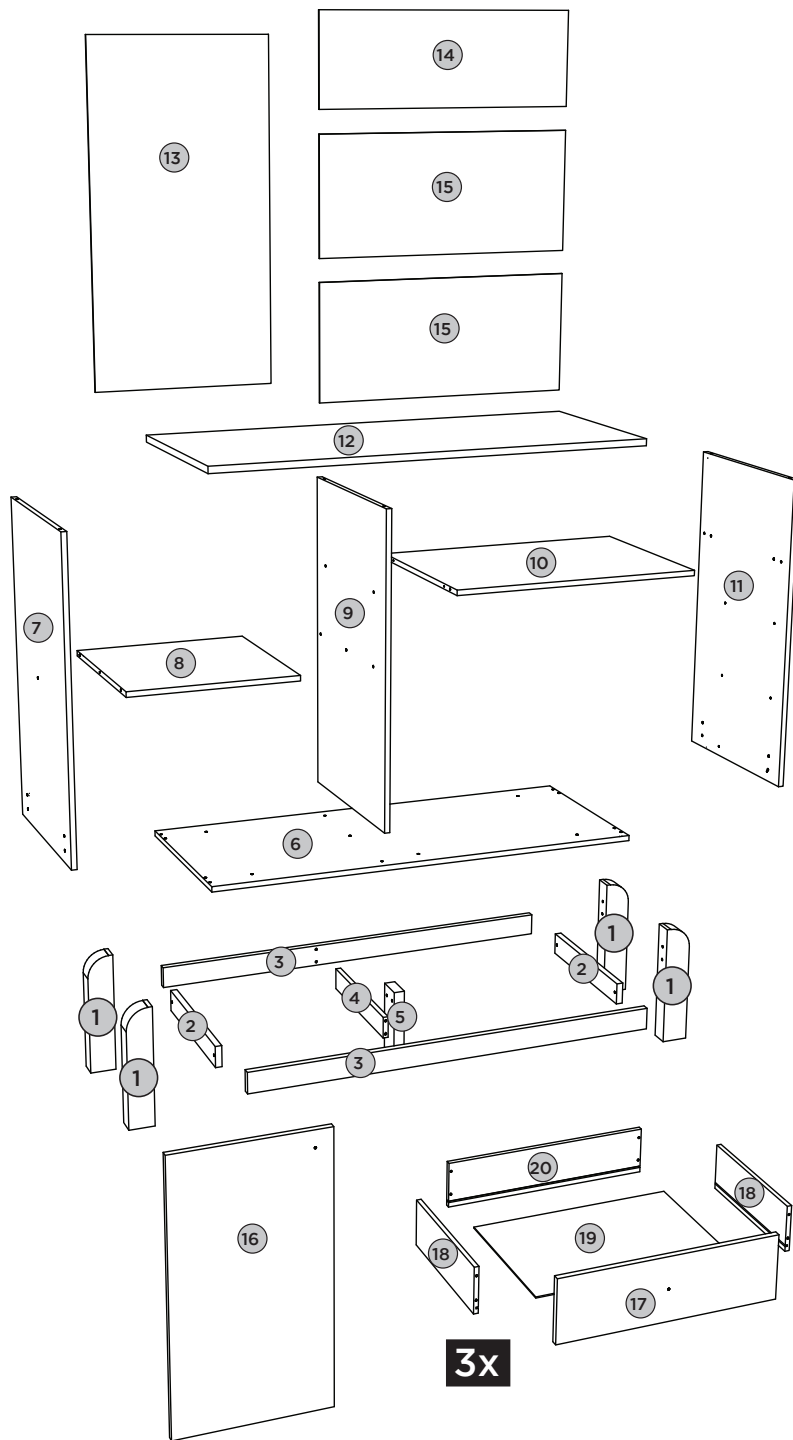

## LISTA DE PEÇAS | LISTA DE PIEZAS | LIST OF PIECES



## PEÇAS REQUERIDAS

1	PÉ	x4
3	TRAVESSA MAIOR	x2
4	TRAVESSA	x1
5	PÉ CENTRAL	x1

## ACESSÓRIOS REQUERIDOS

G		06
H		04
I		05
L		05
M		06



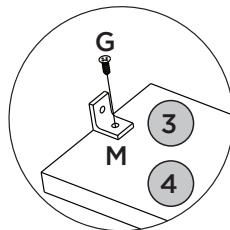
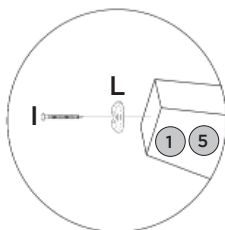
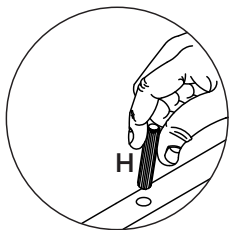
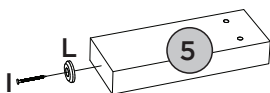
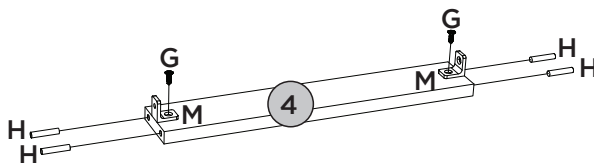
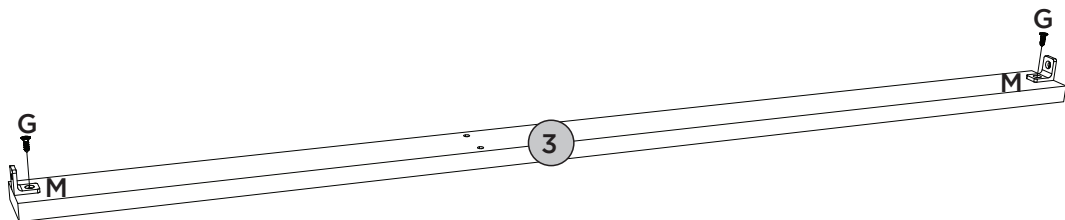
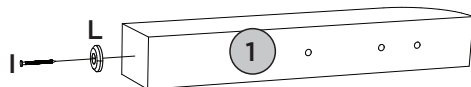
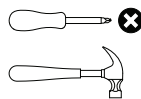

## FERRAMENTAS NECESSÁRIAS



## PEÇAS REQUERIDAS

7	LATERAL ESQUERDA	x1
8	PRATELEIRA	x1
9	DIVISÃO	x1
10	TAMPO DAS GAVETAS	x1
11	LATERAL DIREITA	x1

## ACESSÓRIOS REQUERIDOS

G		25
H		20
M		06
R		02
T		03

## FERRAMENTAS NECESSÁRIAS

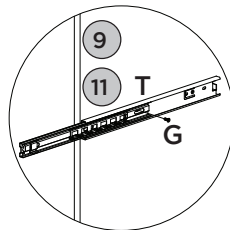
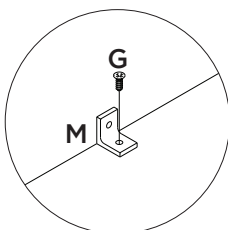
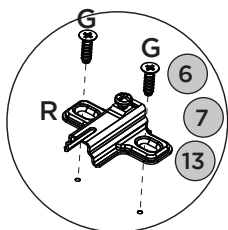
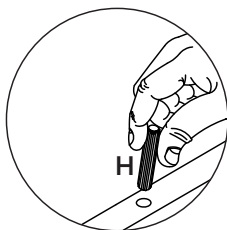
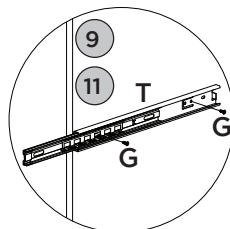
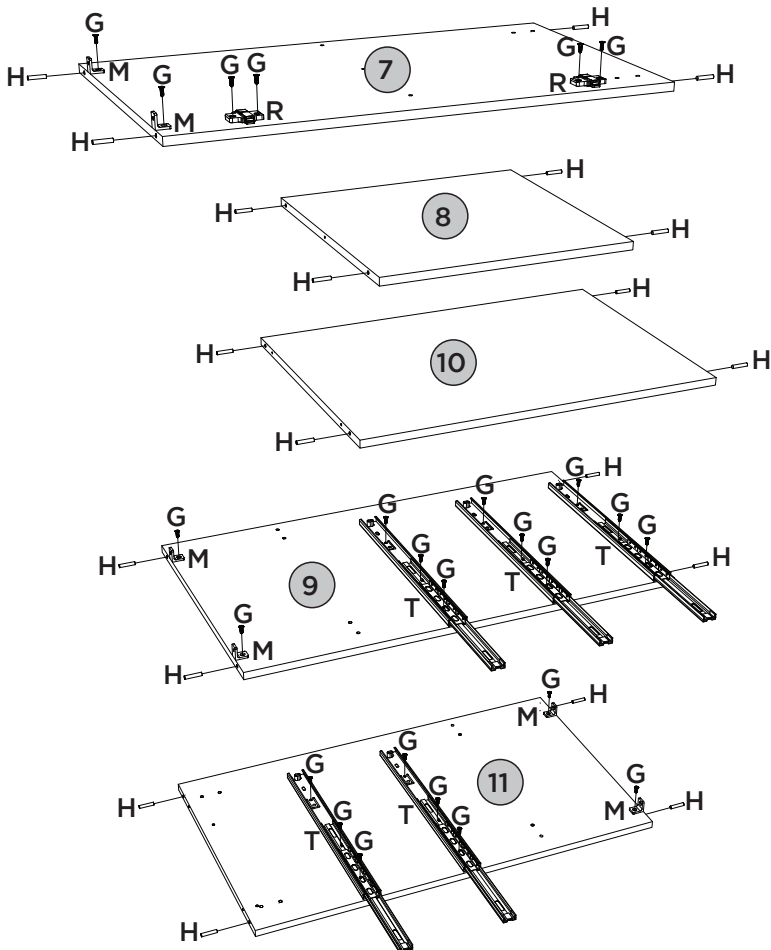
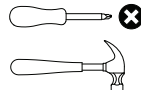

# PASSO 3

ITM/1725-

## PEÇAS REQUERIDAS

1	PÉ	x4
2	TRAVESSA LATERAL	x2

## ACESSÓRIOS REQUERIDOS

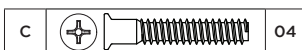

## FERRAMENTAS NECESSÁRIAS

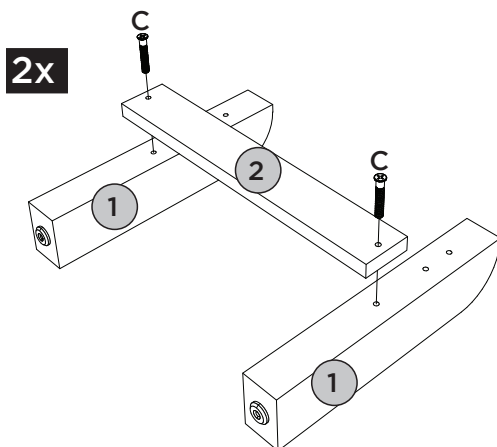
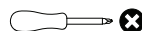

# PASSO 4

## PEÇAS REQUERIDAS

3	TRAVESSA MAIOR	x2
4	TRAVESSA	x1

## ACESSÓRIOS REQUERIDOS





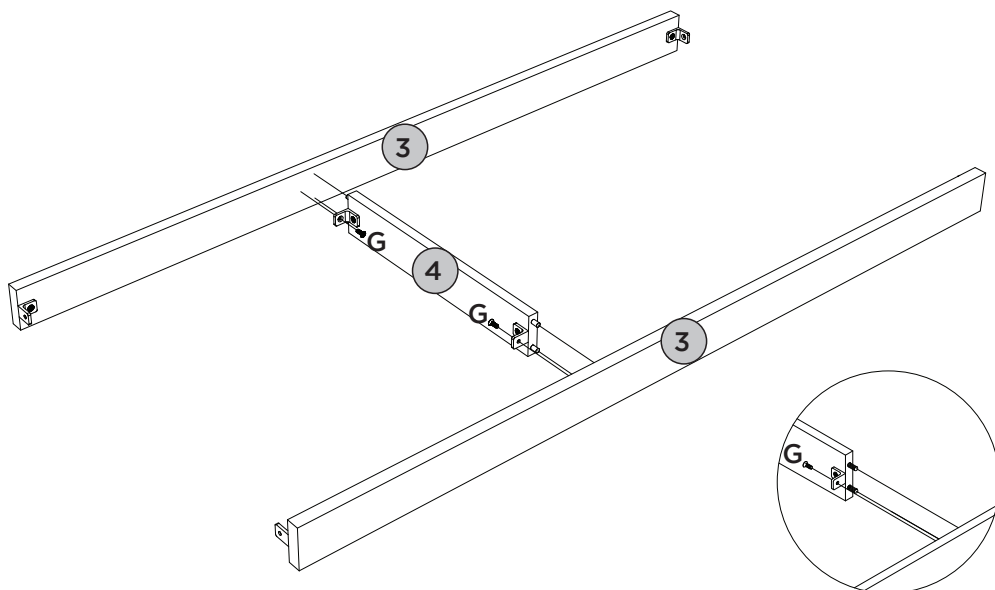
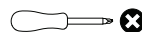

## FERRAMENTAS NECESSÁRIAS



**PASSO 5****PEÇAS REQUERIDAS**

5	PÉ CENTRAL	x1
---	------------	----

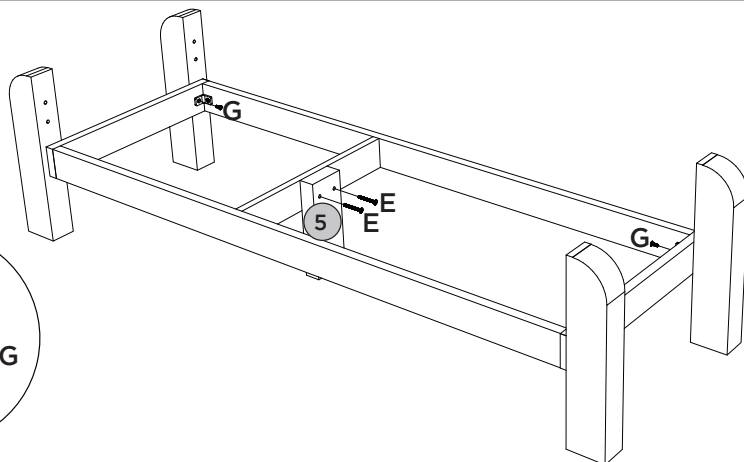
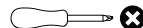

**ACESSÓRIOS REQUERIDOS**

E			02
G			04

**FERRAMENTAS NECESSÁRIAS****PASSO 6****PEÇAS REQUERIDAS**

6	BASE	x1
7	LATERAL ESQUERDA	x1
8	PRATELEIRA	x1
9	DIVISÃO	x1

**ACESSÓRIOS REQUERIDOS**

B			05
---	---	---	----

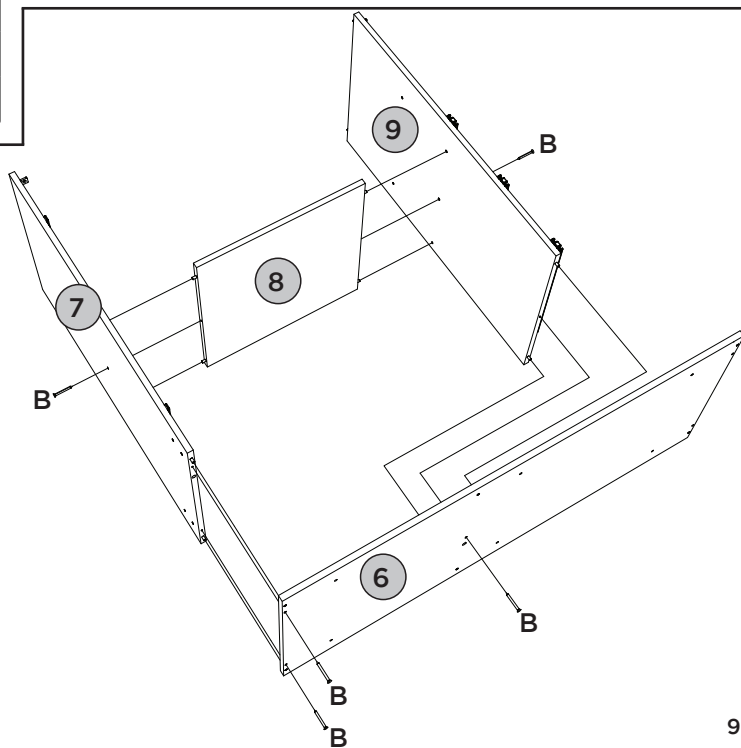
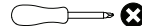
**FERRAMENTAS NECESSÁRIAS**

# PASSO 7

ITM/1725-

## PEÇAS REQUERIDAS

6	TAMPO DAS GAVETAS	x1
7	LATERAL DIREITA	x1

## ACESSÓRIOS REQUERIDOS



## FERRAMENTAS NECESSÁRIAS

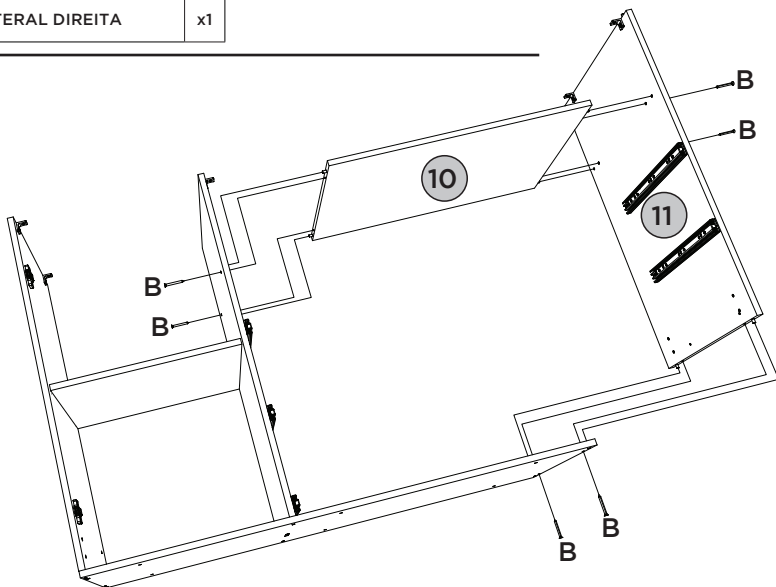
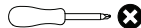

# PASSO 8

## PEÇAS REQUERIDAS

12	TAMPO	x1
----	-------	----

## ACESSÓRIOS REQUERIDOS

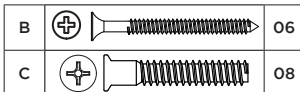

## FERRAMENTAS NECESSÁRIAS

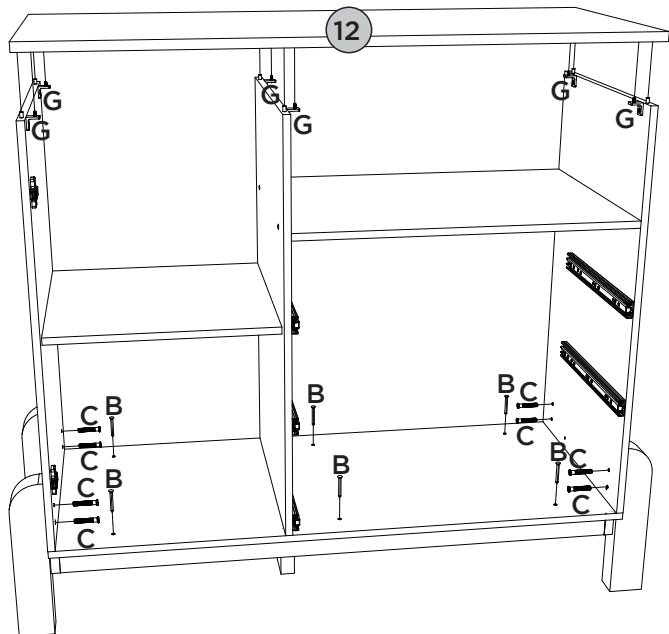
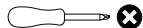



# PASSO 9

ITM/1725-

## PEÇAS REQUERIDAS

13	FUNDO MAIOR	x1
14	FUNDO MENOR	x1
15	FUNDO CRU	x2

## ACESSÓRIOS REQUERIDOS

J		45
K		11
U		01

## FERRAMENTAS NECESSÁRIAS

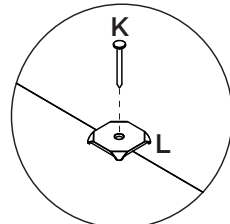
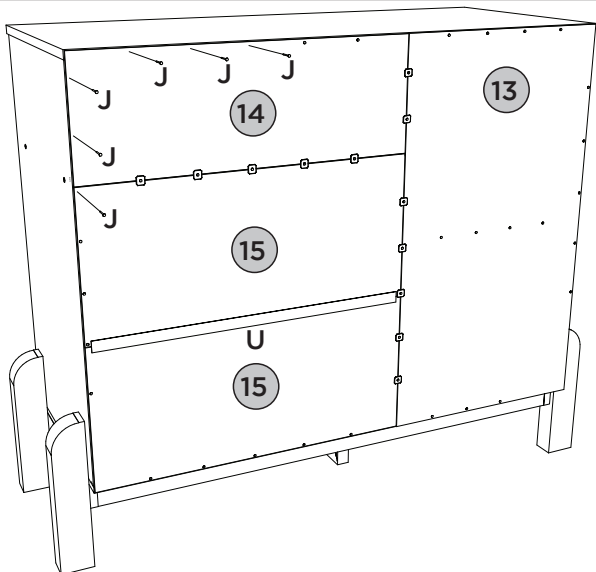





# PASSO 10

## PEÇAS REQUERIDAS

16	PORTA	x1
----	-------	----

## ACESSÓRIOS REQUERIDOS

D		01
G		04
Q		01
S		02

## FERRAMENTAS NECESSÁRIAS

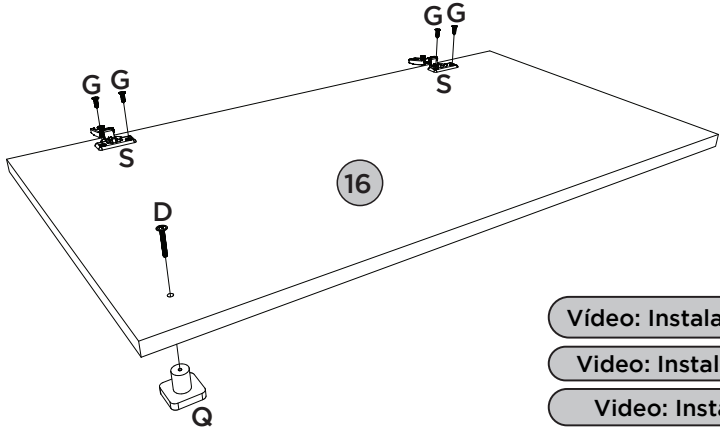
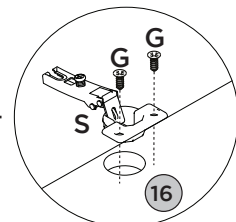
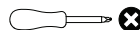



- Vídeo: Instalar e regular Dobradiças
- Vídeo: Instale y ajuste las bisagras
- Vídeo: Install and adjust hinges

# PASSO 11

## PEÇAS REQUERIDAS

16	PORTA	x1
----	-------	----

## ACESSÓRIOS REQUERIDOS

G		03
T		01

## FERRAMENTAS NECESSÁRIAS

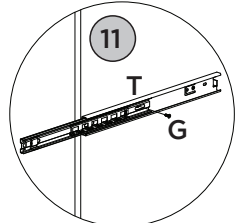
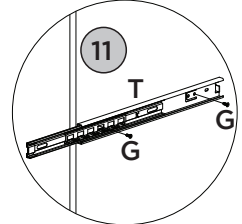
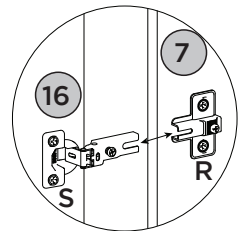
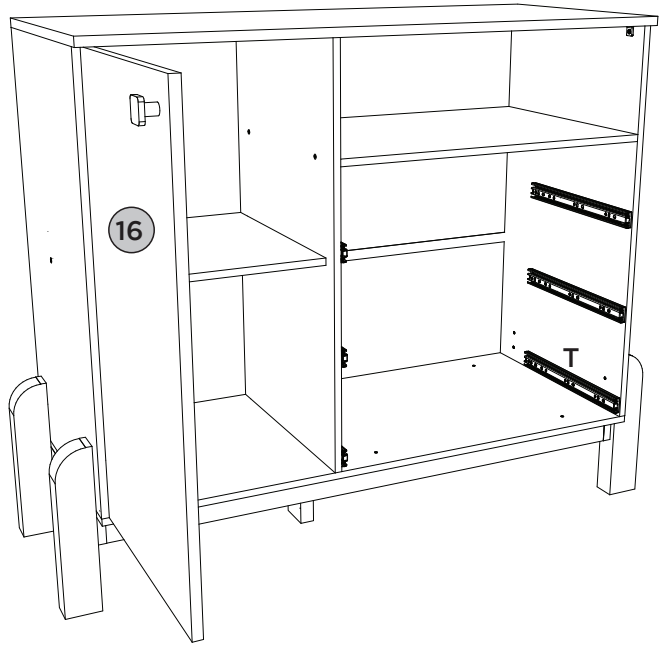
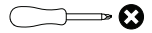



# PASSO 12

## PEÇAS REQUERIDAS

18	LADO DE GAVETA	x6
----	----------------	----

## ACESSÓRIOS REQUERIDOS

H		24
V		

## FERRAMENTAS NECESSÁRIAS

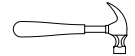

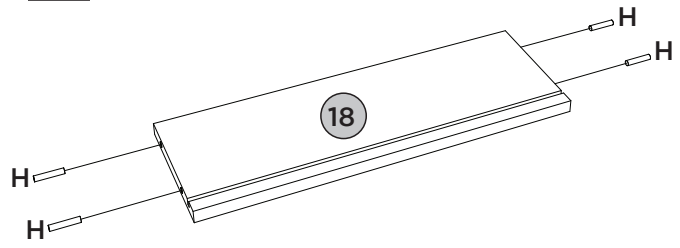

**6x**



## PEÇAS REQUERIDAS

17	FRENTE DE GAVETA	x3
18	LADO DE GAVETA	x6
19	FUNDO DE GAVETA	x3

## ACESSÓRIOS REQUERIDOS

G		12
M		06
V		

## FERRAMENTAS NECESSÁRIAS

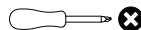
**3x**

1º

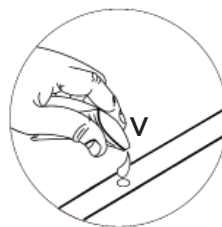
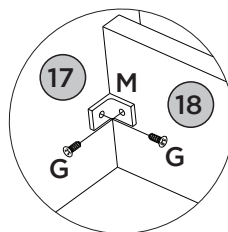
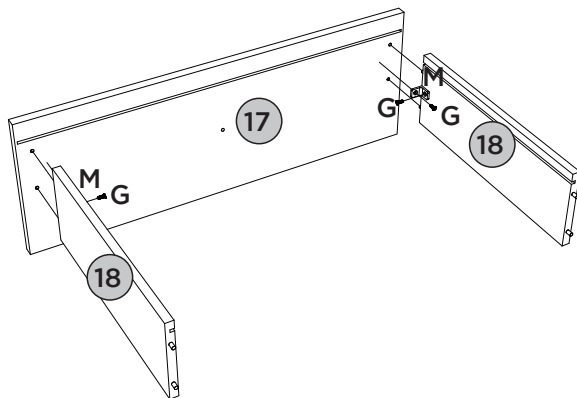
**3x**

2º

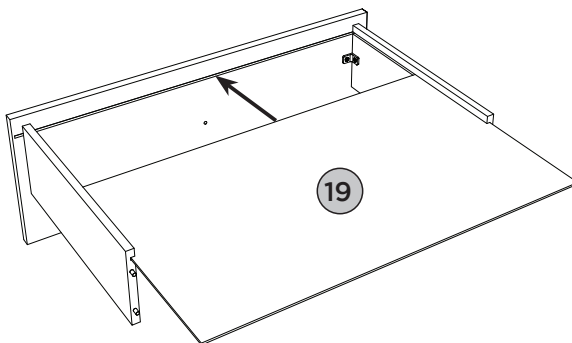
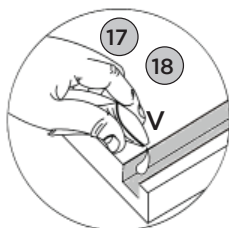

## PEÇAS REQUERIDAS

20	RIPA DE TRÁS	x3
----	--------------	----

## ACESSÓRIOS REQUERIDOS

D		03
F		06
G		18
I		06
N		06

## FERRAMENTAS NECESSÁRIAS

	Q	03
	T	03
	V	

**3x**  
3º

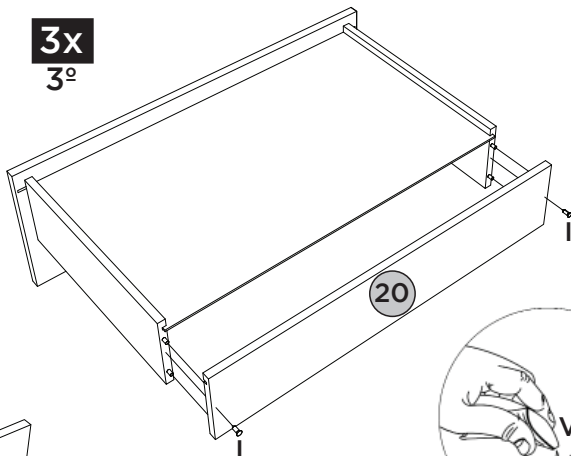

**3x**  
4º

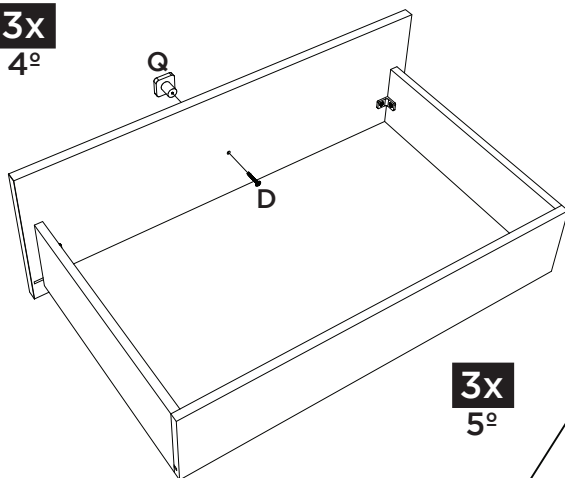

Deixar 3mm de distância da frente de gaveta.

Deje una separación de 3mm del frente del cajón.

Leave 3mm away from the front of the drawer.

**3x**  
5º

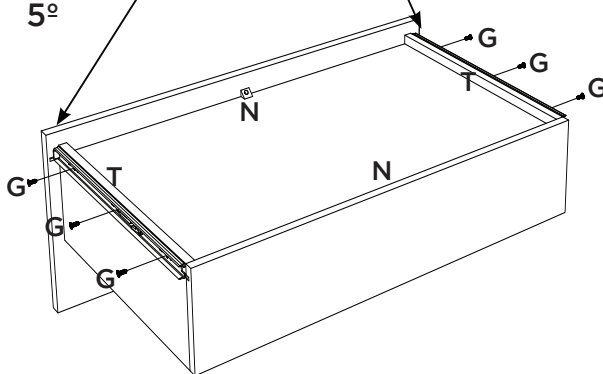
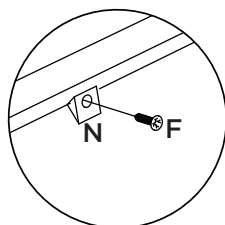

## ACESSÓRIOS REQUERIDOS

A		01
G		02
O		01
P		01

W		08
X		03
Y	<b>HENN</b>	01

## FERRAMENTAS NECESSÁRIAS

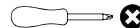

Imprescindível a fixação do produto na parede, a não colocação destas ferragens para fixação (A, G, O e P), poderá permitir que o produto vire, causando acidente.

Es imprescindible la fijación del producto en la pared, la no colocación de estos herrajes para fijación (A, G, O y P), podrá permitir que el El producto se vuelva, causando accidente.

Indispensable to fix the product on the wall, not the placement of these attachment fittings (A, G, O and P), may allow the product to turn, causing an accident.

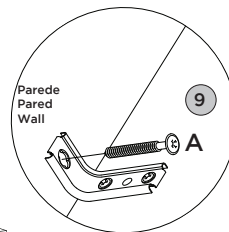
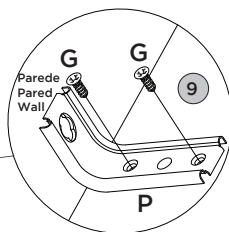
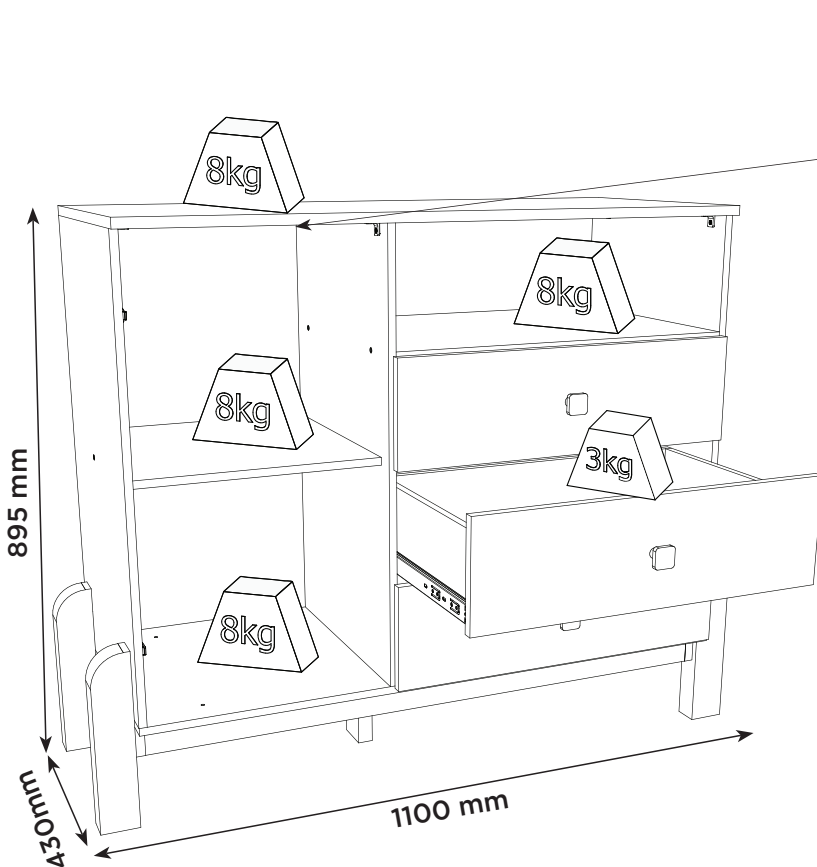

PERFECT CORRECTION  
CORRECCIÓN PERFECTA

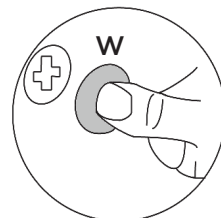
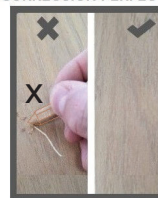

Pesos máximos recomendado con carga distribuída  
 Peso máximo recomendado con la carga distribuída  
 Recommended maximum weight with distributed load.

Produto Concluído  
Producto terminado  
Finished Product



**HENN**Ind. e Com. de Móveis Henn  
Mondai - SC - Brasil

☎ +55 49 3674.3500

📱 @moveishenn  
www.henn.com.br**INSTRUÇÕES DE  
MONTAGEM**INSTRUCCIONES DE MONTAJE  
ASSEMBLY INSTRUCTIONS**Berço Mini Cama Ternura  
Cuna Mini Cama Ternura | Crib Ternura**

I29-190 Branco/Jequitibá HP

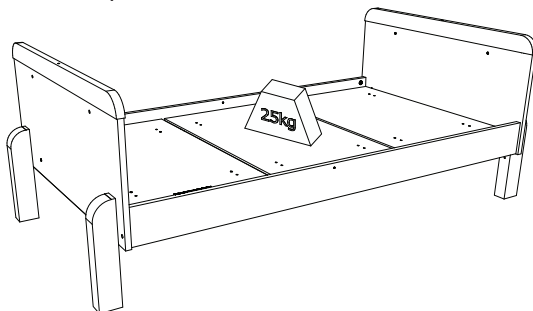
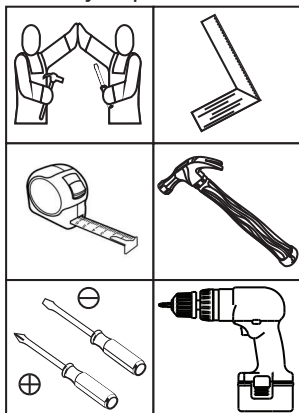
Opção Berço  
Opción de cuna  
Crib OptionOpção Mini Cama  
Opción de cama mini  
Mini Bed OptionPesos máximos recomendados com carga distribuída  
Peso máximo recomendado con la carga distribuída  
Recommended maximum weight with distributed load.**Requisitos para montagem  
Requisitos para la montaje  
Assembly Requirements**Imagens meramente ilustrativas,  
não acompanha o produto.  
Imágenes ilustrativas, no incluidas  
con el producto.  
Illustrative images, not included  
with the product.**AVISO**

Para limpeza de seu móvel, use uma flanela seca ou umedecida, e não utilize produtos químicos que possam danificar seu produto.

**SISTEMA DE MONTAGEM**

O sistema de montagem dos produtos, funciona de acordo com a ordem crescente dos números indicados no desenho. Ex: 01, 02, 03, 04... até a conclusão da montagem.

**ASSISTÊNCIA TÉCNICA**

Para solicitação de Assistência Técnica você consumidor deverá entrar em contato com o Lojista a qual você realizou a compra deste produto e solicitar a assistência técnica das peças avariadas. A garantia abrange todas as peças, partes e componentes que eventualmente venham apresentar defeito de fabricação no prazo de 03 (três) meses, contando a partir da entrega do produto ao consumidor, mediante nota fiscal de compra. Se houver qualquer alteração na estrutura do produto ou ocorrer defeito por negligência do montador/consumidor em relação a instrução de montagem e manuseio, não será fornecido assistência técnica gratuita.

**ADVERTENCIA**

Para limpeza de su móvil, use una flanela seca o húmeda, y no utilice productos químicos que puedan dañar su producto.

**SISTEMA DE MONTAJE**

El sistema de montaje de los productos funciona de acuerdo con el orden creciente de los números indicados en el dibujo. Ej.: 01, 02, 03, 04... hasta la conclusión del montaje.

**ASSISTENCIA TÉCNICA**

Para solicitar Asistencia Técnica, el consumidor debe comunicarse con el Comercio que usted realizó la compra de este producto y solicita asistencia técnica para las partes dañadas. La garantía cubre todas las partes, piezas y componentes que eventualmente puedan presentar defecto de fabricación en el plazo de 03 (tres) meses, contados a partir de la entrega del producto al consumidor, mediante factura de compra. Si se produce algún cambio en la estructura del producto o se produce un defecto por negligencia del montador/consumidor en relación con las instrucciones de montaje y manipulación, no se prestará asistencia técnica gratuita.

**NOTICE**

To clean your furniture, use a dry or wet cloth, and do not use chemicals that may damage your product.

**ASSEMBLY SYSTEM**

The products' assembly system works according to the increasing order of the indicated numbers. For example: 01, 02, 03, 04 ... to the end of the assembly.

**TECHNICAL ASSISTANCE**

To request Technical Assistance, the consumer must contact the retailer from whom you purchased this product and request technical assistance for the damaged parts. The warranty covers all parts, parts and components that may eventually present a manufacturing defect within a period of 03 (three) months, counting from the delivery of the product to the consumer, by means of a purchase invoice. If there is any change in the structure of the product or defect occurs due to negligence of the assembler/consumer in relation to the assembly and handling instruction, free technical assistance will not be provided.

# IMPORTANTE LER COM ATENÇÃO E GUARDAR PARA EVENTUAIS CONSULTAS

I) **Advertências:** Não posicionar ou utilizar o produto perto de chama aberta e outras fontes de calor, tais como aquecedores elétricos, aquecedores a gás ou outras fontes, pois o material é inflamável.

II) Não utilize o berço se alguma parte estiver quebrada, rasgada ou faltando. Utilizar somente peças de reposição recomendadas pelo fabricante.

III) Não deixe nenhum objeto dentro ou próximo ao berço que possa servir de ponto de apoio ou ofereça risco de sufocação, engasgamento ou estrangulamento, como, por exemplo, cordas, cordões de persianas/cortina, protetores, almofadas, brinquedos, fios e cabos de aparelhos elétricos.

IV) Nunca utilizar mais de um colchão no berço.

V) Crianças pequenas não podem brincar, sem vigilância, nas proximidades de um berço.

VI) **Atenção:** quando a criança for capaz de escalar o berço, ele não pode mais ser utilizado por essa criança, pois este berço foi construído para uso por crianças com capacidade motora para sentar-se, ajoelhar-se e/ou levantar-se sozinhas, porém que ainda não sejam capazes de escalar o berço.

VII) Para berços com mais de uma função, não sujeita à regulamentação: Este produto atende à regulamentação para berços infantis, não sendo as suas demais funções sujeitas à regulamentação.

VIII) Este berço não pode ser alterado, seja em sua estrutura ou em seus adornos, pois riscos à segurança da criança podem ser gerados.

IX) O comprimento e a largura do colchão utilizado com o berço devem atender as especificações deste Manual.

I) **Orientações:** A Sociedade Brasileira de Pediatria orienta colocar o bebê para dormir de barriga para cima, pois diminui em 70% o risco de morte súbita. Recomendamos conversar com o pediatra de seu filho para maiores informações.

II) Só utilize o berço quando estiver totalmente montado conforme as orientações do Manual de Instruções e após certificar que seus sistemas de travamento estão devidamente acionados.

III) O Berço deve ser colocado sobre um piso horizontal.

IV) Para berços com altura da base ajustável: A posição mais baixa é a mais segura e a base deve ser sempre utilizada nessa posição tão logo o bebê tenha idade suficiente para sentar-se.

V) Quando existirem dispositivos de apoio destacáveis para apoiar a base do berço acima da sua posição mais baixa: Antes que o berço seja utilizado na sua posição mais baixa, devem ser removidos os dispositivos usados para apoiar a base em posições mais altas.

VI) As conexões de montagem devem ser sempre apertadas adequadamente e verificadas regularmente, ao longo do uso do berço, e reapertadas conforme necessário.

VII) Caso alguma parte do berço quebre ou apresente defeito, deve-se procurar assistência técnica especializada e não serem realizados consertos caseiros.

VIII) Orientações para a espessura do colchão, que podem ser dadas pelas seguintes formas:

a) O comprimento e a largura do colchão utilizado com o berço devem ser tais que nunca seja possível a formação de espaço maior que 30mm entre as laterais ou extremidades e o colchão.

b) A espessura do colchão deve ser tal que a altura interna (da superfície do colchão até a borda superior da armação do berço) seja de pelo menos 480mm na posição mais baixa da base do berço e pelo menos 180mm na posição mais elevada da base do berço.

c) Quando for utilizada uma marcação no berço para indicar a espessura máxima do colchão: A marcação no berço indica a espessura máxima do colchão a ser utilizado com o berço.

IX) **Recomendação sobre o tamanho mínimo de colchão a ser utilizado com o berço.**

Para o Berço Mini Cama Ternura, recomenda-se o uso de colchão de 1,30 m  $\pm$  0,5 cm de comprimento, 70 cm  $\pm$  0,5 cm de largura e 12 cm  $\pm$  0,5 cm de altura, com densidade mínima de

# IMPORTANTE LEER CON ATENCIÓN Y GUARDAR PARA EVENTUALES CONSULTAS

I) **Advertencias:** No colocar o utilizar el producto cerca de llama abierta y otras fuentes de calor, tales como calentadores eléctricos, calentadores de gas u otras fuentes, ya que el material es inflamable.

II) No utilice la cuna si alguna parte está rota, rasgada o faltada. Utilice sólo piezas de repuesto recomendadas por el fabricante.

III) No deje ningún objeto dentro o cerca de la cuna que pueda servir de punto de apoyo o ofrezca riesgo de sofocación, engaño o estrangulamiento, como por ejemplo cuerdas, cordones de persianas / cortinas, protectores, cojines, juguetes, hilos y cables de aparatos eléctricos.

IV) Nunca utilizar más de un colchón en la cuna.

V) Los niños pequeños no pueden jugar, sin vigilancia, en las proximidades de una cuna.

VI) Atención: cuando el niño es capaz de escalar la cuna, ya no puede ser utilizado por ese niño, pues esta cuna fue construida para uso por niños con capacidad motora para sentarse, arrodillarse y / o levantarse pero que todavía no son capaces de escalar la cuna.

VII) Para cunas con más de una función, no sujeta a la reglamentación: Este producto atiende a la reglamentación para cunas infantiles, no siendo sus demás funciones sujetas a la reglamentación.

VIII) Esta cuna no puede ser alterada, sea en su estructura o en sus adornos, pues riesgos a la seguridad del niño pueden ser generados.

IX) La longitud y la anchura del colchón utilizado con la cuna deben cumplir las especificaciones de este manual.

I) **Orientaciones:** La Sociedad Brasileña de Pediatría orienta a colocar al bebé para dormir de barriga hacia arriba, pues disminuye en un 70% el riesgo de muerte súbita. Recomendamos conversar con el pediatra de su hijo para mayor información.

II) Sólo utilice la cuna cuando esté totalmente montado de acuerdo con las instrucciones del Manual de instrucciones y después de asegurarse de que sus sistemas de bloqueo están debidamente accionados.

III) La cuna debe colocarse sobre un piso horizontal.

IV) Para cunas con altura de base ajustable: La posición más baja es la más segura y la base debe ser siempre utilizada en esa posición tan pronto como el bebé tenga la edad suficiente para sentarse.

V) Cuando existan dispositivos de apoyo desmontables para apoyar la base de la cuna por encima de su posición más baja: Antes de que la cuna se utilice en su posición más baja, se deben quitar los dispositivos utilizados para apoyar la base en posiciones más altas.

VI) Las conexiones de montaje siempre deben ajustarse adecuadamente y verificadas regularmente, a lo largo del uso de la cuna, y reapertadas según sea necesario. VII) Si alguna parte de la cuna se rompe o presenta defecto, se debe buscar asistencia técnica especializada y no realizar reparaciones caseras.

VIII) Orientaciones para el espesor del colchón, que pueden darse de las siguientes formas:

a) La longitud y la anchura del colchón utilizado con la cuna deben ser tales que nunca sea posible la formación de espacio mayor a 30 mm entre los laterales o los extremos y el colchón.

b) El espesor del colchón debe ser tal que la altura interna (de la superficie del colchón hasta el borde superior del armazón de la cuna) sea de al menos 480 mm en la posición más baja de la base de la cuna y al menos 180 mm en la posición más elevada de la base de la cuna.

c) cuando se utilice un marcado en la cuna para indicar el espesor máximo del colchón: El marcado en la cuna indica el grosor máximo del colchón que se utilizará con la cuna.

IX) Recomendación sobre el tamaño mínimo de colchón que se utilizará con la cuna. Para la Cuna Mini Cama Ternura, se recomienda el uso de un colchón de  $1,30 \text{ m} \pm 0,5 \text{ cm}$  longitud,  $70 \text{ cm} \pm 0,5 \text{ cm}$  de ancho y  $12 \text{ cm} \pm 0,5 \text{ cm}$  de alto, con una densidad mínima de  $18 \text{ kg} / \text{m}^3 \pm 2,0 \text{ kg} / \text{m}^3$  (D18).

# WARNING READ WITH ATTENTION AND SAVE FOR EVENTUAL CONSULTATIONS

- I) **Warnings:** Do not position or use the product near open flame and other sources of heat such as electric heaters, gas heaters or other sources as the material is flammable.
- II) Do not use the crib if any part is broken, torn or missing. Use only replacement parts recommended by the manufacturer.
- III) Do not leave any object in or near the crib that may serve as a foothold or risk of suffocation, choking or strangulation, such as ropes, blinds / curtain cords, protectors, cushions, toys, wires and cables of electrical appliances.
- IV) Never use more than one mattress in the crib.
- V) Small children may not play, unattended, in the vicinity of a crib.
- VI) **Caution:** when the child is able to climb the crib, it can no longer be used by this child, as this crib was built for use by children with motor ability to sit, kneel and / or get up alone but not yet able to climb the crib.
- VII) For cribs with more than one function, not subject to regulation: This product complies with regulations for baby cribs, and its other functions are not subject to regulation.
- VIII) This crib can not be altered, either in its structure or in its adornments, because risks to the child's safety can be generated.
- IX) The length and width of the mattress used with the crib must comply with the specifications of this Manual.
- I) **Guidelines:** The Brazilian Society of Pediatrics advises to place the baby to sleep on his belly up, as it reduces the risk of sudden death by 70%. We recommend talking to your child's pediatrician for more information.
- II) Only use the crib when fully assembled in accordance with the instructions in the Instruction Manual and after making sure that your locking systems are properly engaged.
- III) The crib must be placed on a horizontal floor.
- IV) For cribs with adjustable base height: The lowest position is the safest and the base should always be used in this position as soon as the baby is old enough to sit.
- V) When there are detachable supporting devices to support the crib base above its lowest position: Before the crib is used in its lowest position, the devices used to support the crib in the highest positions should be removed.
- VI) The mounting connections must always be tightened properly and checked regularly, throughout the use of the crib, and retightened as necessary.
- VII) If any part of the crib breaks or is defective, you should look for expert technical assistance and no home repairs.
- VIII) Guidelines for the thickness of the mattress, which may be given in the following ways:
- a) The length and width of the mattress used with the crib shall be such that it is never possible to form a space greater than 30 mm between the sides or ends and the mattress.
- b) The thickness of the mattress shall be such that the inner height (from the mattress surface to the upper edge of the cradle frame) is at least 480 mm in the lowest position of the cradle base and at least 180 mm in the highest position of the cradle of the crib.
- c) When a marking is used on the crib to indicate the maximum thickness of the mattress: The marking on the crib indicates the maximum thickness of the mattress to be used with the crib.
- IX) Recommendation on the minimum size of mattress to be used with the crib. For Crib Mini Bed Ternura, the use of a 1,30 m  $\pm$  0.5 cm mattress is recommended length, 70 cm  $\pm$  0,5 cm wide and 12 cm  $\pm$  0,5 cm high, with a minimum density of 18 kg / m<sup>3</sup>  $\pm$  2,0 kg / m<sup>3</sup> (D18).

**O REGISTRO NO INMETRO E O  
SELO DE IDENTIFICAÇÃO DA  
CONFORMIDADE REFEREM-SE  
SOMENTE AO BERÇO**





**EL REGISTRO EN EL INMETRO Y  
EL SELLO DE IDENTIFICACIÓN  
DE LA CONFORMIDAD SE  
REFERE SOLAMENTE AL BERZO**

**THE INMETRO REGISTRATION  
AND THE CONFORMITY IDEN-  
TIFICATION SEAL REFER ONLY  
TO THE CRIB**

**PASSO 1****PEÇAS NECESSÁRIAS**

1 - TRAVESSA	x2
2 - PÉ	x4
3 - LATERAL INFERIOR	x2
5 - LATERAL SUPERIOR	x2
7 - TRAVESSA PARA BERÇO	x2

**FERRAGENS NECESSÁRIAS**

E		08
F		20
G		04
H		04
I		04

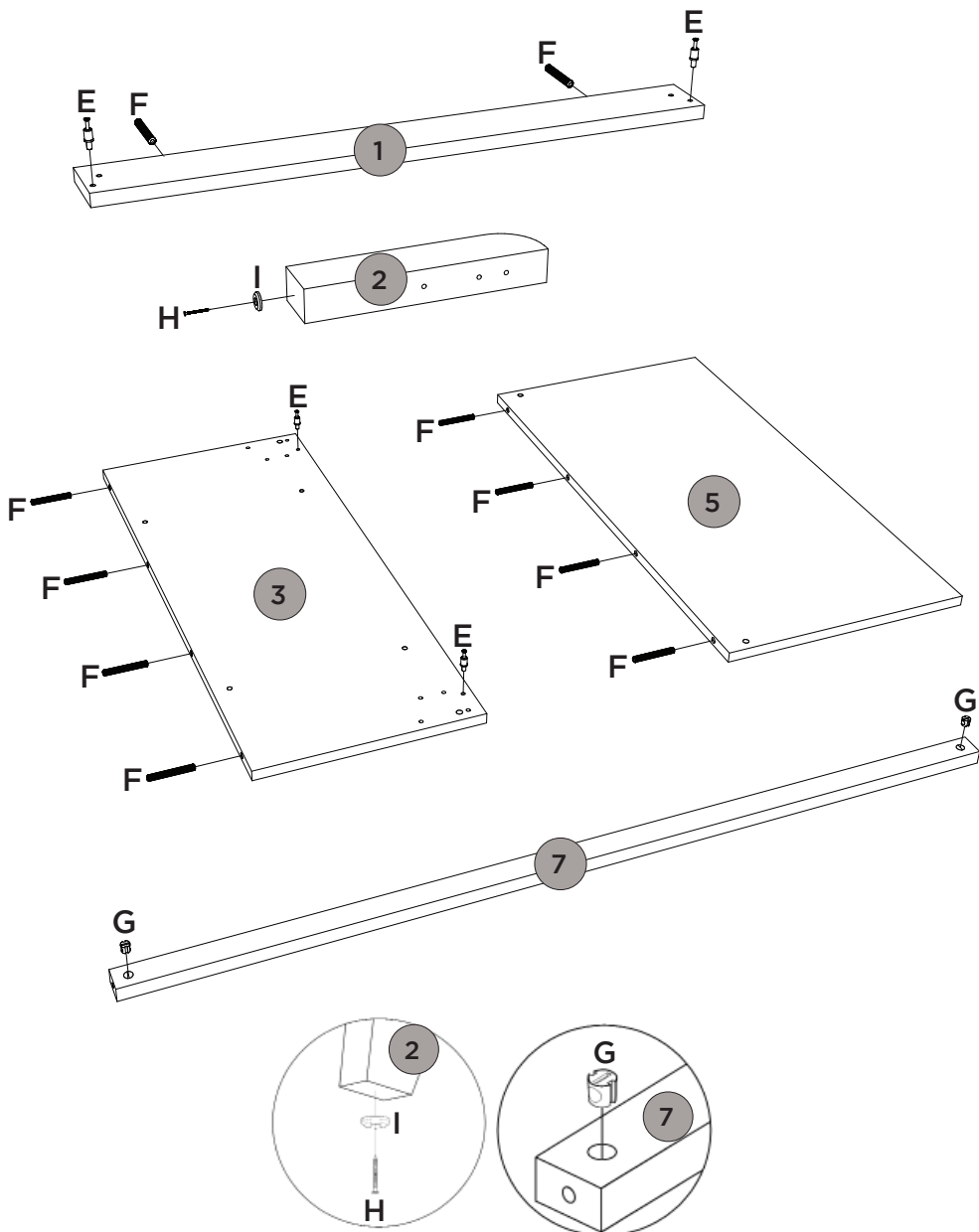
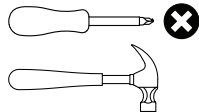
**FERRAMENTAS**

**PASSO 2****PEÇAS NECESSÁRIAS**

1 - TRAVESSA	x2
2 - PÉ	x4
3 - LATERAL INFERIOR	x2

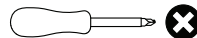
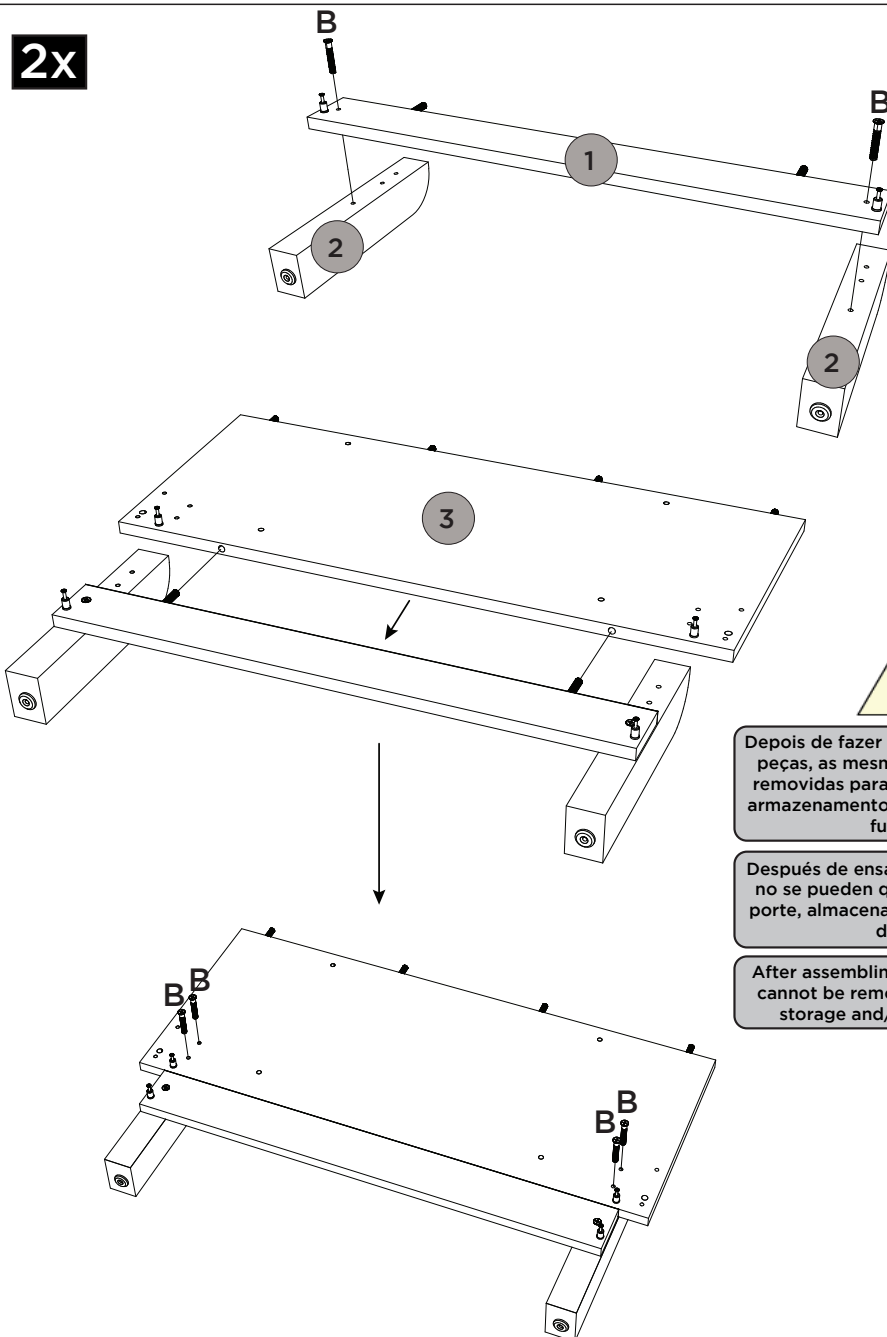
**FERRAGENS NECESSÁRIAS****FERRAMENTAS****2x**

Depois de fazer a montagem destas peças, as mesmas não podem ser removidas para fins de transporte, armazenamentos e/ou alteração de função.

Después de ensamblar estas piezas, no se pueden quitar para el transporte, almacenamiento y/o cambio de rol.

After assembling these parts, they cannot be removed for transport, storage and/or role change.

**PASSO 3****PEÇAS NECESSÁRIAS**

4 - TRAVESSA MAIOR x2

5 - LATERAL SUPERIOR x2

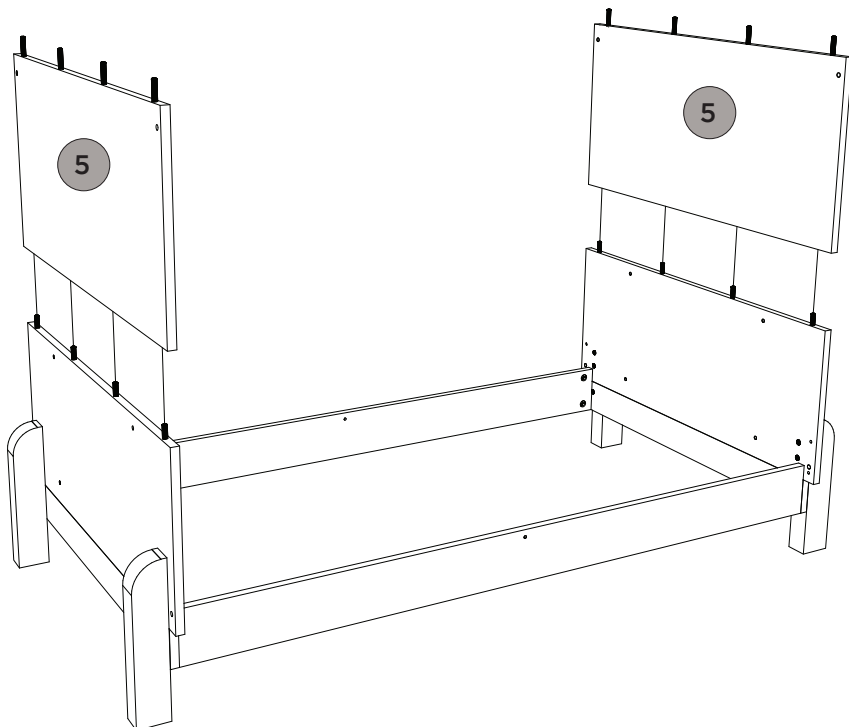
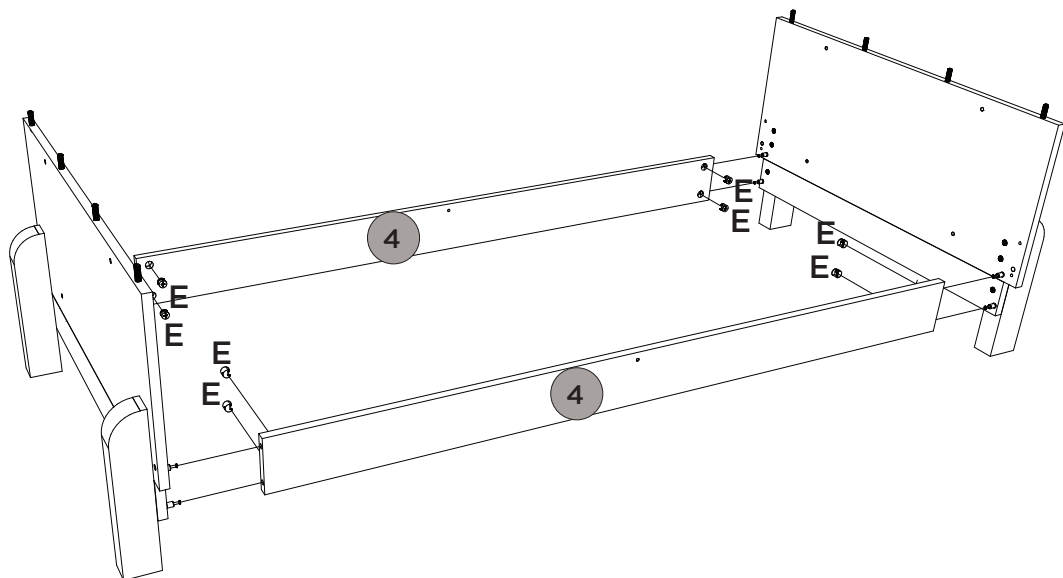
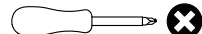
**FERRAGENS NECESSÁRIAS**E  08**FERRAMENTAS**

**PASSO 4****PEÇAS NECESSÁRIAS**

6 - GRADE FIXA

x1

**FERRAGENS NECESSÁRIAS**

A



04

C

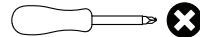

01

**FERRAMENTAS**

OU

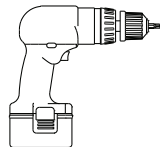

Utilizar a parafusadeira com o torque em 15 para fixar a grade e para fixar o lastro.

Utilizar la atornilladora con el torque en 15 para fijar la rejilla y para fijar el lastre.

Use the screwdriver with the torque at 15 to attach the rail and base frame.

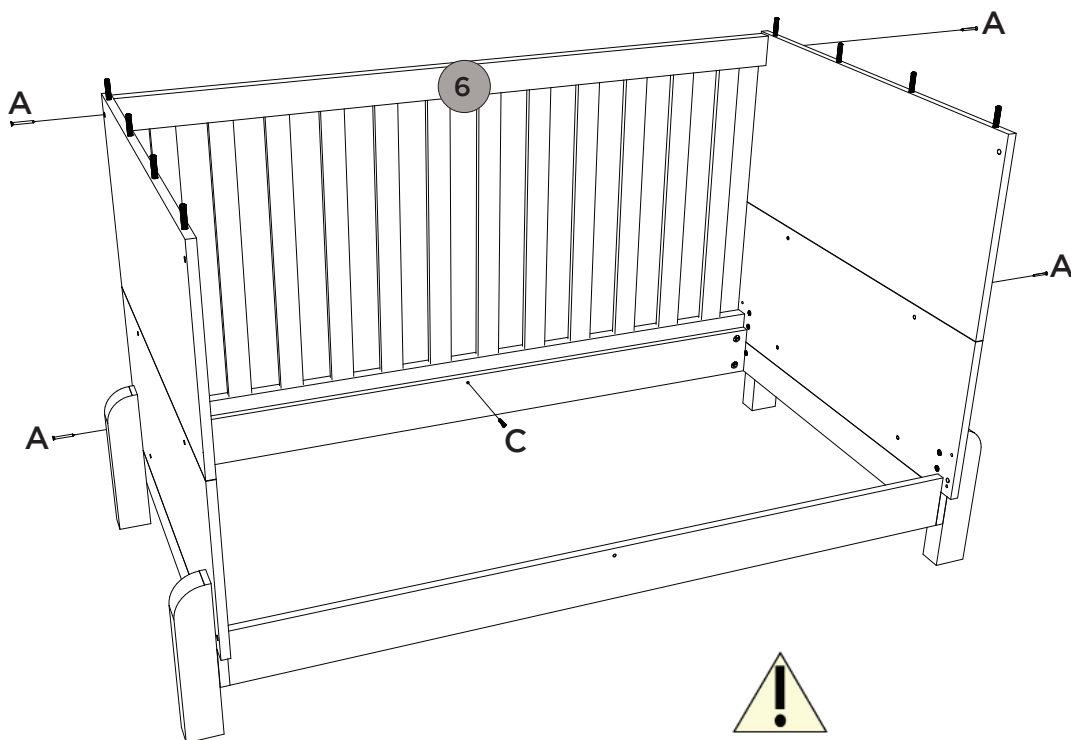

Depois de fazer a montagem destas peças, as mesmas não podem ser removidas para fins de transporte, armazenamentos e/ou alteração de função.

Después de ensamblar estas piezas, no se pueden quitar para el transporte, almacenamiento y/o cambio de rol.

After assembling these parts, they cannot be removed for transport, storage and/or role change.



- Opções para montar o Lastro
- Opciones para montar el balasto
- Options for mounting the Ballast

Vista Interna da Lateral

Vista Interna Lateral

Side Internal View

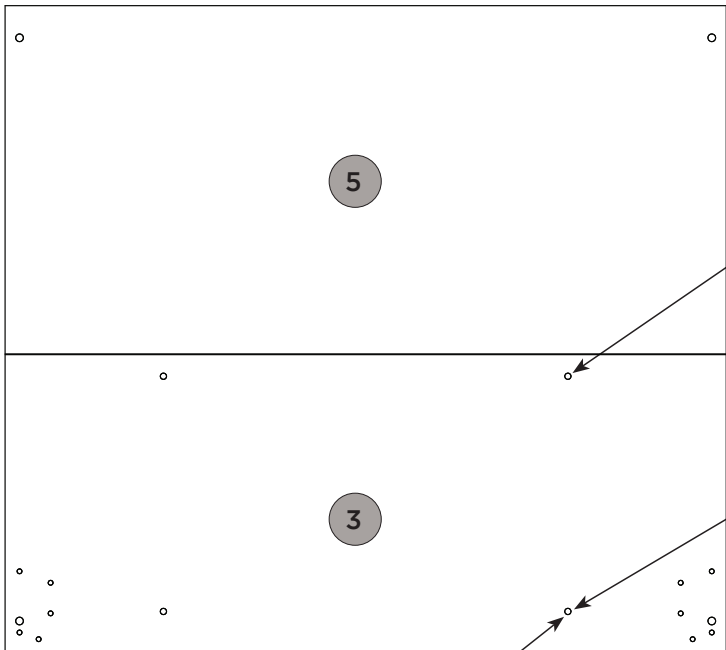

Furação para Berço -  
Opção mais alta do lastro

Perforación de cuna -  
Opción de lastre superior

Cradle Drilling -  
Higher Ballast Option

Furação para Berço -  
Opção mais baixa do lastro

Perforación de cuna -  
Opción de lastre inferior

Cradle Drilling -  
Lower Ballast Option

Furação para Opção  
Mini Cama



Mini cama Opción de  
perforación

Mini Bed Option Drilling

**PASSO 6****PEÇAS NECESSÁRIAS**

7 - TRAVESSA PARA BERÇO	x2
8 - LASTRO MAIOR 6MM COM CARIMBO E ETIQUETA	x1
9 - LASTRO MAIOR 6MM	x2
10 - MOLDURA SUPERIOR	x2

**FERRAGENS NECESSÁRIAS**

A		04
C		12

**FERRAMENTAS**

OU

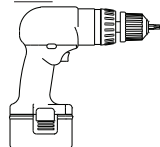

Utilizar a parafusadeira com o torque em 15 para fixar a grade e para fixar o lastro.

Utilizar la atornilladora con el torque en 15 para fijar la rejilla y para fijar el lastro.

Use the screwdriver with the torque at 15 to attach the rail and base frame.

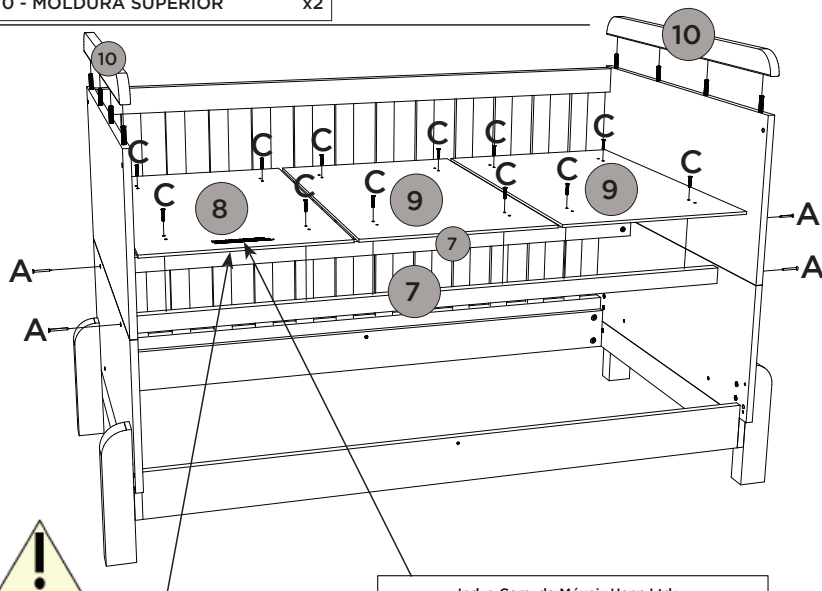

Selo de identificação da conformidade no lado contrário do carimbo

Sello de identificación del cumplimiento por parte opuesto de sello

Identification seal of the compliance on the side opposite of stamp

Ind. e Com. de Móveis Henn Ltda.  
CNPJ 85.355.592/0001-17  
Berço Mini Cama Ternura

Norma ABNT NBR 15860-1 :2016;  
Recomenda-se o uso de colchões com espessura máxima permitida de 120mm conforme ABNT NBR 13579-1.

PEDIDO: (numero) LOTE: (numero) DATA: (dia/mês/ano)

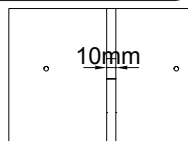

A distância entre os lastros deve ser 10mm.

La distancia entre los lastres debe ser 10mm.

The distance between ballast should be 10mm.

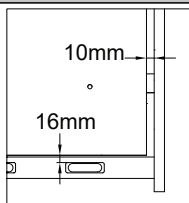

Para a opção mais alta a distância entre os lastros da extremidade com as laterais deverá ser de 10mm.

Para la opción más alta, la distancia entre los balastos en el extremo y los lados debe ser de 10 mm.

For the highest option, the distance between the ballasts at the end and the sides should be 10mm.

As extremidades dos lastros (8) e (9) devem ficar 16mm da grade fixa (6).

Lastres extremos (8) y (9) deben quedar 16mm de la rejilla fija (6).

The end base frames (8) and (9) must be 16mm from the fixed rail (6).



Os Lastros (8 e 9) não podem ser removidos da travessa (7) para fins de transporte, armazenamentos e/ou alteração de função.

Los muelles (8 y 9) no se pueden quitar del tramo (7) con el fin de transporte, almacenamiento y / o cambio de función.

The ballasts (8 and 9) can not be removed from the beam (7) for purposes of transportation, storage and / or change of function.

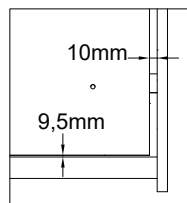

Para a opção mais baixa a distância entre os lastros da extremidade com as laterais deverá ser de 10mm.

Para la opción más baja, la distancia entre los balastos de los extremos y los laterales debe ser de 10 mm.

For the lowest option, the distance between the end ballasts and the sides must be 10mm.

As extremidades dos lastros (8) e (9) devem ficar 9,5mm da grade fixa (6).



Lastres extremos (8) y (9) deben quedar 9,5mm de la rejilla fija (6).

The end base frames (8) and (9) must be 9,5mm from the fixed rail (6).

## PEÇAS NECESSÁRIAS

11 - GRADE FIXA	x1
12 - SUPORTE MOSQUITEIRO	x1

## FERRAGENS NECESSÁRIAS

A		04
C		01

## FERRAMENTAS

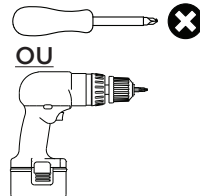

Utilizar a parafusadeira com o torque em 15 para fixar a grade e para fixar o lastro.

Utilizar la atornilladora con el torque en 15 para fijar la rejilla y para fijar el lastre.

Use the screwdriver with the torque at 15 to attach the rail and base frame.



Depois de fazer a montagem destas peças, as mesmas não podem ser removidas para fins de transporte, armazenamentos e/ou alteração de função.

Después de ensamblar estas piezas, no se pueden quitar para el transporte, almacenamiento y/o cambio de rol.

After assembling these parts, they cannot be removed for transport, storage and/or role change.

Montagem berço concluída

Montaje cuna completa

Completed crib assembling

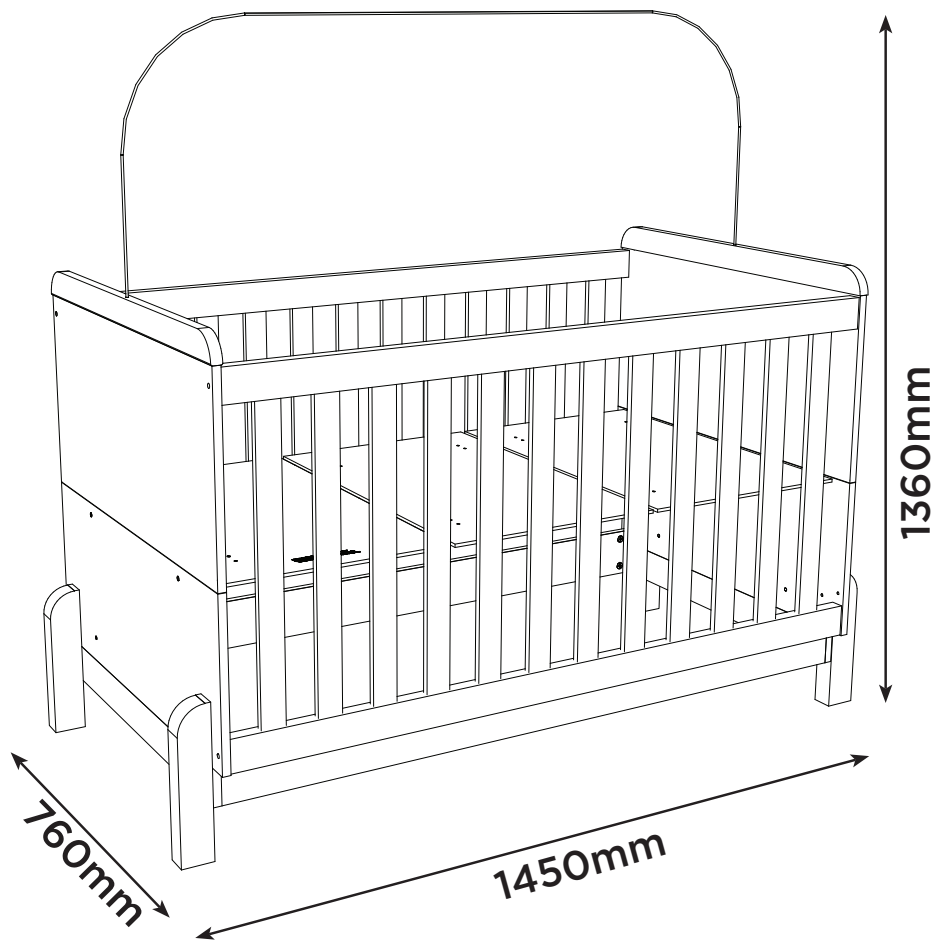

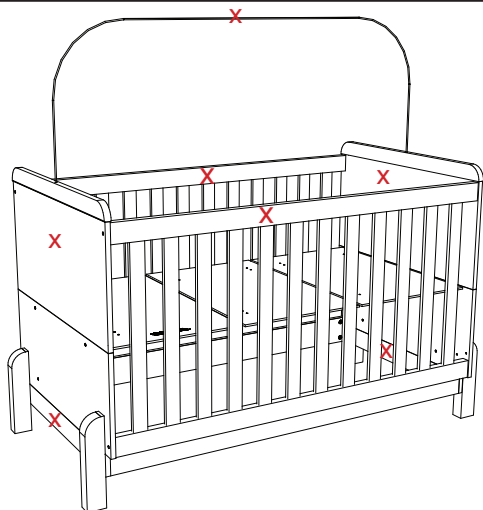

Para a montagem da mini cama, tirar as peças marcadas com "X" e o restante das peças deverão ser utilizadas para a montagem da mini cama.

Para el montaje de la mini cama, sacar las piezas marcadas con "X" y el resto de las piezas deberán ser utilizadas para el montaje de la mini cama.

To assemble the mini bed, remove the parts marked with "X" and the remaining parts should be used to assemble the mini bed.

### PASSO 8

#### PEÇAS NECESSÁRIAS

3 - LATERAL INFERIOR	x2
4 - TRAVESSA MAIOR	x2
10 - MOLDURA SUPERIOR	x2

#### FERRAGENS NECESSÁRIAS

E		08
---	---	----

#### FERRAMENTAS

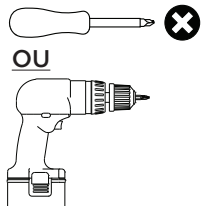

Utilizar a parafusadeira com o torque em 15 para fixar o lastro.

Utilice el destornillador con un par de 15 para fijar el lastre.

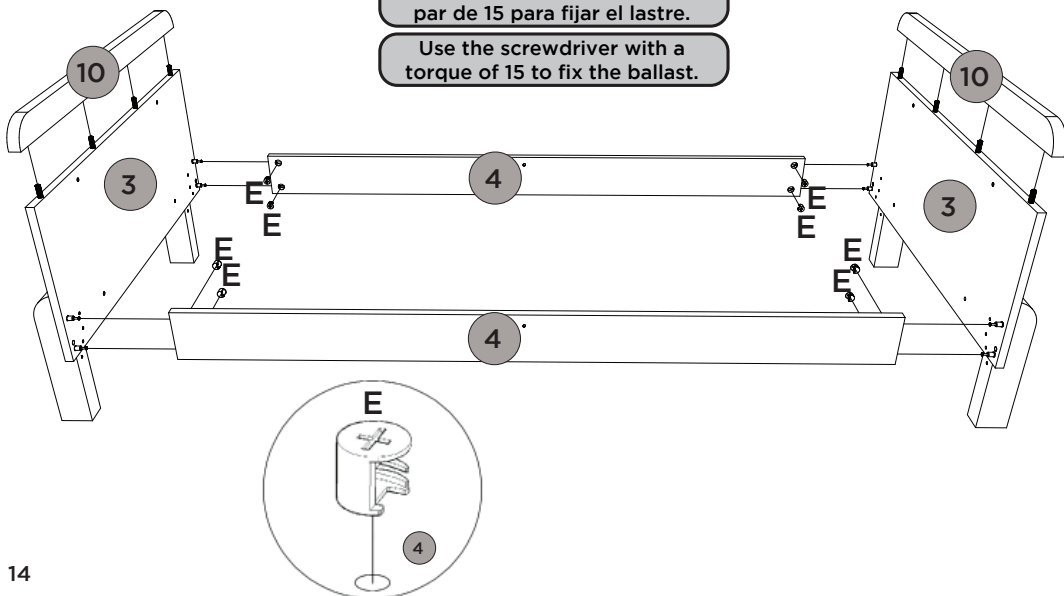

Use the screwdriver with a torque of 15 to fix the ballast.



**PASSO 9****PEÇAS NECESSÁRIAS**

7 - TRAVESSA PARA BERÇO	x2
8 - LASTRO MAIOR 6MM COM CARIMBO E ETIQUETA	x1
9 - LASTRO MAIOR 6MM	x2

**FERRAGENS NECESSÁRIAS**

A		04
J		20

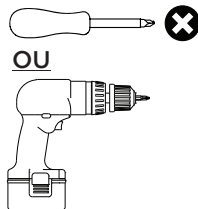
**FERRAMENTAS**

Utilizar a parafusadeira com o torque em 15 para fixar o lastro.

Utilice el destornillador con un par de 15 para fijar el lastre.

Use the screwdriver with a torque of 15 to fix the ballast.

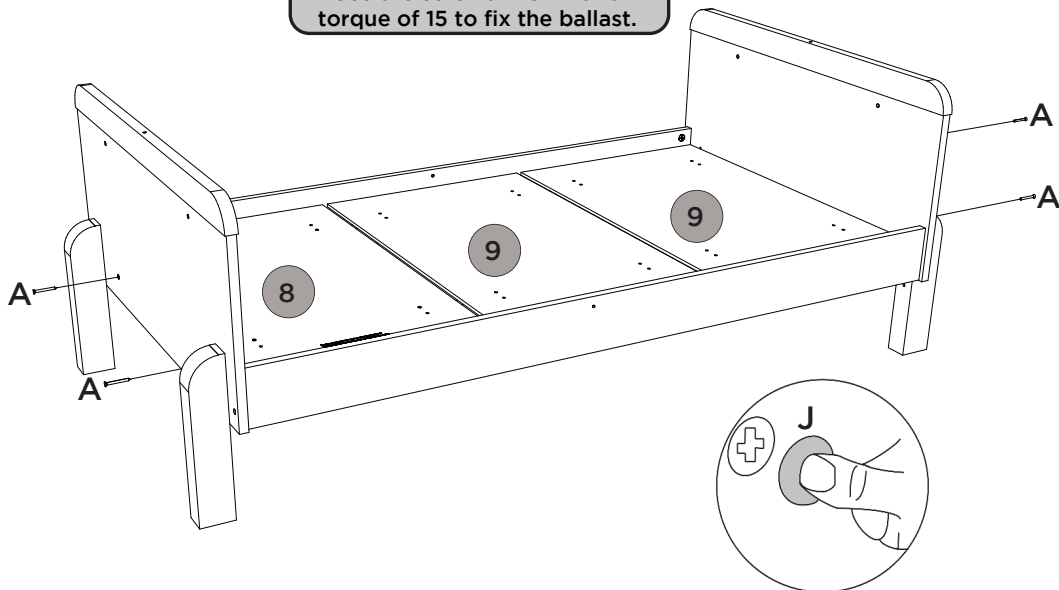

**Mini Cama concluído**

**Mini cama completa**

**Mini Bed Complete**

Na Opção Mini Cama pode ser utilizado os Adesivos Tapa parafusos (J), aonde há furos aparentes.

En la Opción de Mini Cama, se pueden usar los Adhesivos para Cubiertas de Tornillos (J), donde hay agujeros aparentes.



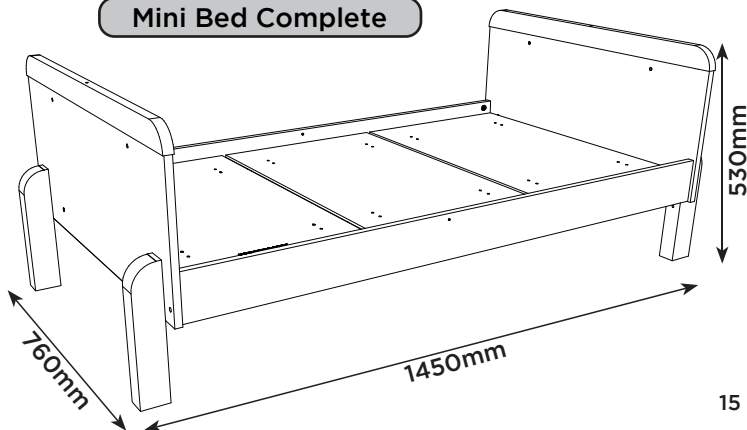



In the Mini Bed Option, the Screw Cover Adhesives (J) can be used, where there are apparent holes.



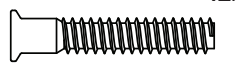

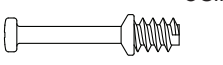
## Lista de Peças | Lista de piezas | List of parts

Item	Caixa Caja Box	Qtd Ctd Qty	Descrição Descripción Description	Medidas (mm)   Dimensions (mm)   Size (measurements) (mm)
01	1/1	02	Travessa   Travesão   Frame	700x70x15
02	1/1	04	Pé   Pie   Foot	280x60x40
03	1/1	02	Lateral Inferior   Lado Inferior   Lower Side	755x310x15
04	1/1	02	Travessa Maior   Plato Grande   Big Platter	1301x100x15
05	1/1	02	Lateral Superior   Lado Superior   Upper side	755x365x15
06=11	1/1	01	Grade fixa   Rejilla fija   Fixed Rail	1300x670x25
07	1/1	02	Travessa para berço   Travesão para Cuna   Crib Frame	1301x36x22
08	1/1	01	Lastro maior 6mm com carimbo e etiqueta   Lastre mayor 6mm con sello y etiqueta   Larger ballast 6mm with stamp and label	680x420x6
09	1/1	02	Lastro maior 6mm   Lastre mayor 6mm   6mm Largest Base Frame	680x420x6
10	1/1	02	Moldura Superior   Marco Superior   Top Frame	757x50x20
11=06	1/1	01	Grade fixa   Rejilla fija   Fixed Rail	1300x670x25
12	1/1	01	Suporte mosquito   Soporte de mosquiteros   Mosquito net support	1320mm

## Ferragens | Herrajes | Hardware

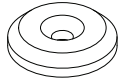
<b>A</b>	12x	<b>B</b>	12x	<b>C</b>	14x	<b>D</b>	08x
							
Parafuso 1/4x50mm PAN. Tornillo 1/4x50mm PAN. Screw 1/4x50mm PAN.		Parafuso 7,0x40mm CHT. Tornillo 7,0x40mm CHT. Screw 7,0x40mm CHT.		Parafuso 4,5x25mm CHT. Tornillo 4,5x25mm CHT. Screw 4,5x25mm CHT.		Parafuso minifix Tornillo minifix Minifix bolt	
<b>E</b>	08x	<b>F</b>	20x	<b>G</b>	04x	<b>H</b>	04x
							
Tambor minifix Tambor minifix Minifix nut		Cavilha 8x60mm Tarugo 8x60mm Dowel 8x60mm		Porca Zamac 12x12 Tuerca Zamac 12x12 Zamac nut 12x12		Prego 12x12mm Anelado Clavo 12x12mm Anillado Ringed Nails 12x12mm	

<b>I</b>	04x	<b>J</b>	20x
			
Sapata Deslizadora Zapata Deslizadora shoe Deslizadora		Adesivo tapa parafuso 10mm Adhesivo tapón de tornillo 10mm Bolt cover adhesive 10mm	

**IMPORTANTE**

Os itens (J) serão usados apenas na Opção Mini Cama

**IMPORTANTE**

Los artículos (J) solo se utilizarán en la Opción Mini Bed

**IMPORTANT**

Items (J) will only be used in Option Mini Bed



Após desmontar ou alterar a função do Berço, o mesmo não poderá ser montado novamente.

Después de desmontar o cambiar la función de la cuna, no se puede volver a montar.

After disassembling or changing the Cradle's function, it cannot be reassembled.

# Agora que você já comprou o seu móvel, ele merece ser montado do jeito certo.

Erros de montagem causam mais de **60%** dos danos em móveis.

## Por que contratar?

Tranquilidade do **início ao fim** da montagem



### PROFISSIONAIS QUALIFICADOS

Especialistas certificados na **MadeiraMadeira Serviços**.



### FERRAMENTAS PROFISSIONAIS

que **protegem** seus móveis.



### AGENDAMENTO EM 24 HORAS

escolha a data e o turno **ideais para** você.



### GARANTIA DE 3 MESES

de cobertura **completa**.

**Mais de 1 MILHÃO DE MONTAGENS**  
★ com avaliação 4.7 ★

#### Mariana S., São Paulo

"Chegaram no horário e montaram tudo rapidamente. Serviço incrível!"



#### Carlos R., Belo Horizonte

"Tentei montar sozinho e foi um desastre. Com a **MadeiraMadeira Serviços** ficou perfeito."



#### Ana P., Rio de Janeiro

"Agendamento ágil e **montagem pontual e perfeita**. Recomendo demais!"



Agende agora pelo  
**QR Code**



Madeira**Madeira** Serviços · Atendimento em todo o Brasil

Escaneie o QRCode