

CL100

REVISÃO/REVISIÓN/REVISION:02

INSTRUÇÕES DE MONTAGEM

INSTRUCCIONES DE MONTAJE

ASSEMBLY'S INSTRUCTIONS



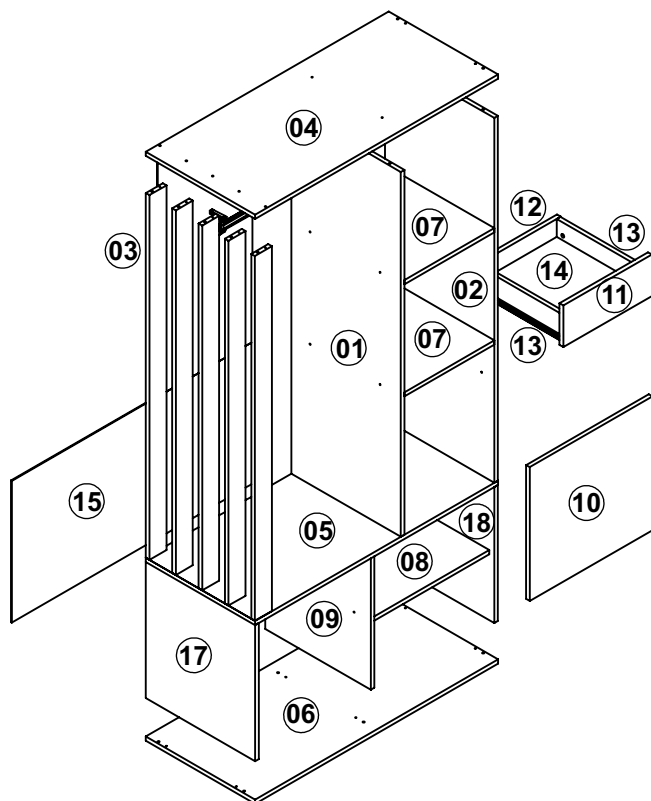



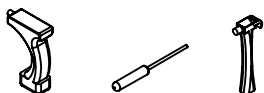



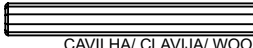

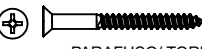
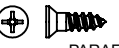

 @prodecormoveis

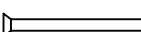
 Rua: José Sachet / 213 A / Bairro São Francisco
 Farroupilha / RS / 95171-018 / Fone:(54) 3261-1165

FERRAMENTAS NECESSÁRIAS:
 HERRAMIENTAS NECESARIAS:
 NECESSARY TOOLS:

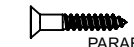

LISTA DE PEÇAS / LISTA DE PIEZAS / FURNITURE PIECES LIST			
COD	DESCRIÇÃO/DESCRIPCIÓN/DESCRIPTION	DIMENSÃO/DIM/DIM	QTD
01	LATERAL ESQUERDA/ LATERAL IZQUIERDA/ LEFT SIDE	1300X450X15	01
02	LATERAL DIREITA/ LATERAL DERECHO/ RIGHT SIDE	1300X450X15	01
03	TRAVESSA/ TRAVESAÑO/ CROSSPIECE	1300X70X15	05
04	TAMPO/ TAPA / TOP	1000X450X15	01
05	TAMPO CENTRAL/ TAPA CENTRAL/ CENTRAL TOP	1000X450X15	01
06	BASE/ BASE/ BASE	1000X450X15	01
07	PRATELEIRA/ ESTANTE/ SHELF	370X450X15	02
08	PRATELEIRA/ ESTANTE/ SHELF	477X430X15	01
09	DIVISÓRIA/ DIVISIÓN/ DIVISION	485X434X15	01
10	PORTA/ PUERTA/ DOOR	505X477X15	01
11	FRENTE DE GAVETA/ FRENTE DEL CAJÓN/ FRONT OF THE DRAWER	364X148X15	01
12	TRASEIRA DE GAVETA/ TRASERA DEL CAJÓN/ BACK OF THE DRAWER	349X65X15	01
13	LATERAL DE GAVETA/LATERAL DEL CAJÓN/ SIDE OF THE DRAWER	350X90X15	02
14	FUNDO DE GAVETA/ FONDO DEL CAJÓN/ BOTTOM OF THE DRAWER	370X336X3	01
15	COSTA/ FONDO/ BACK	990X505X3	01
17	LATERAL ESQUERDA/ LATERAL IZQUIERDA/ LEFT SIDE	485X450X15	01
18	LATERAL DIREITA/ LATERAL DERECHO/ RIGHT SIDE	485X450X15	01

REF	DESCRIÇÃO	QTD
A	 CAVILHA/ CLAVIJA/ WOOD DOWEL 6x50MM	02
B	 CAVILHA/ CLAVIJA/ WOOD DOWEL 6x30MM	42
C	 PARAFUSO/ TORNILLO/ SCREW 3,5x40 CC	36
E	 PARAFUSO/ TORNILLO/ SCREW 3,5x14 CC	40
F	 PARAFUSO/ TORNILLO/ SCREW	04
G	 TAMBOR MINIFIX/ TUERCA MINIFIX/ MINIFIX DRUM 12MM	04
H	 CANTONEIRA/ ESQUINERO/ CORNER 18X18	06
I	 CORREDIÇA/ CORREDERA/ SLIDE	01
K	 PREGO/ CLAVO/ NAIL 10X10	40
L	 DOBRADIÇA/ BISAGRA/ HINGE (CANECO 26 CALÇO 12)	02
M	 CABIDEIRO/ COLGADOR/ HANGER SUPPORT 510 MM	01
N	 SAPATA DESLIZADORA/ ZAPATO/ SHOE	06
O	 SUPORTE CABIDEIRO/ SOPORTO DE COLGADOR/ HANGER SUPPORT	02
P	 ADESIVO TAPA FURO/ ADHESIVO/ STICKER	12
Q	 COLA	01
R		01
S	 PARAFUSO/ TORNILLO/ SCREW 4x25 CC	04

IMPORTANTE LER COM ATENÇÃO E GUARDAR PARA EVENTUAIS CONSULTAS.
 IMPORTANT TO READ CAREFULLY AND SAVE FOR ANY QUERIES.
 IMPORTANTE LEER CON ATENCIÓN Y GUARDAR PARA EVENTUALES CONSULTAS.

Instruções de Montagem

Instrucciones de Montaje
Assembly's Instructions

RECOMENDAÇÕES:

01 - Examine completamente todas as peças do móvel antes de iniciar o trabalho.

02 - Recomenda-se montar o móvel conforme este Manual de Montagem.

03 - É de responsabilidade do montador seguir as instruções do Manual de Montagem, que são fundamentais para garantir a estrutura do móvel.

04 - Certifique-se de que todos os acessórios utilizados na montagem (parafusos, porcas, ponteiros) estejam fixados o suficiente, totalmente atarraxados, evitando que venham a provocar ferimentos.

LIMPEZA:

01 - Pano levemente umedecido com água, seguido de pano seco.

02 - Não utilizar produtos químicos ou abrasivos.

GARANTIA:

01 - 3 meses para defeitos ou vícios de origem.

ADVERTÊNCIAS:

01 - Esteja ciente do risco de chama aberta e outras fontes de calor, tais como aquecedores elétricos, aquecedores a gás etc. nas proximidades do produto.

02 - Não utilize o produto se alguma parte estiver quebrada, rasgada ou faltando. Utilizar somente peças de reposição aprovadas pelo fabricante.

RECOMENDACIONES:

01 - Examine completamente todas las piezas del mueble antes de empezar el montaje.

02 - Recomienda-se montar el mueble de acuerdo con este Manual de Montaje.

03 - Es de responsabilidad del montador seguir las instrucciones del Manual de Montaje, que son fundamentales para asegurar la estructura del mueble.

04 - Asegure-se de que todos los accesorios utilizados en el montaje (tornillos, tuercas, ponteras) estén fijados el suficiente, totalmente roscados, evitando que vengam a provocar lesiones.

LIMPIEZA:

01 - Paño levemente humedecido con agua, siguiendo de paño seco.

02 - No utilizar productos químicos o abrasivos.

GARANTÍA:

01 - 3 meses para defectos o vicios de origen.

ADVERTENCIAS:

01 - Tenga en cuenta el riesgo de llama abierta y otras fuentes de calor, tales como calentadores eléctricos, calentadores de gas, etc. en las proximidades del producto.

02 - No utilice el producto si alguna parte esté rota, o perdida. Utilizar sólo piezas de repuesto aprobadas por el fabricante.

RECOMENDATIONS:

01 - Check completely all the furniture's pieces before start to assemble it.

02 - It is recommended to assemble this furniture according to this Assembly's Manual.

03 - It is the assembler's responsibility to follow the instructions of this Assembly's Manual, which are essential to ensure the furniture's structure.

04 - Ensure that all the accessories used in the assembly (bolts, nuts, tips) are well and enoughly fixed, completely threaded, avoiding injuries from happening.

CLEANSING:

01 - Cloth slightly moistened with water.

02 - Do not use chemicals or abrasives products.

WARRANTY:

01 - 3 months due to manufacture defects.

WARNINGS:

01 - Be aware of the risk of open flame and other sources of heat, such as electric heaters, gas heaters etc. around the product.

02 - Do not use the product if any part is broken, torn or missing. Only use replacement parts approved by the manufacturer.

INSTRUÇÃO DE MONTAGEM INSTRUCCIONES DE MONTAJE ASSEMBLY'S INSTRUCTIONS

COLOCAR COLA "Q" NAS CAVILHAS "B".
COLOCAR PEGAMENTO "Q" EN LAS CLAVIJAS "B".
PLACE GLUE "Q" ON DOWELS "B".

