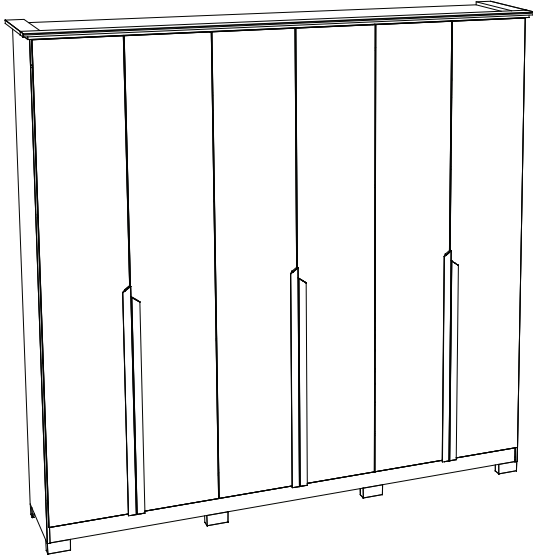
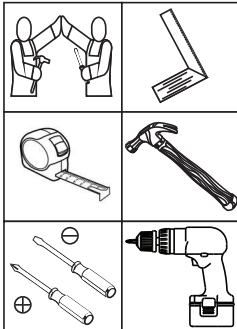

HENNInd. e Com. de Móveis Henn
Mondai - SC - Brasil

☎ +55 49 3674.3500

📱 @moveishenn
www.henn.com.br**INSTRUÇÕES DE
MONTAGEM**INSTRUCCIONES DE MONTAJE
ASSEMBLY INSTRUCTIONS**Roupeiro Andréas 6 Portas 6 Gavetas | Armario Andréas 6 Puertas 6 Cajones |
Wardrobe Andréas 6 Doors 6 Drawers****D309-127 Nature/Off White
D309-169 Cinza/Nature****Requisitos para montagem
Requisitos para la montaje
Assembly Requirements**

Imagens meramente ilustrativas,
não acompanha o produto.
Imágenes ilustrativas, no incluidas
con el producto.
Illustrative images, not included
with the product.

AVISO

Para limpeza de seu móvel, use uma flanela seca ou umedecida, e não utilize produtos químicos que possam danificar seu produto.

SISTEMA DE MONTAGEM

O sistema de montagem dos produtos, funciona de acordo com a ordem crescente dos números indicados no desenho. Ex: 01, 02, 03, 04... até a conclusão da montagem.

ASSISTÊNCIA TÉCNICA

Para solicitação de Assistência Técnica você consumidor deverá entrar em contato com o Lojista a qual você realizou a compra deste produto e solicitar a assistência técnica das peças avariadas. A garantia abrange todas as peças, partes e componentes que eventualmente venham apresentar defeito de fabricação no prazo de 03 (três) meses, contando a partir da entrega do produto ao consumidor, mediante nota fiscal de compra. Se houver qualquer alteração na estrutura do produto ou ocorrer defeito por negligência do montador/consumidor em relação a instrução de montagem e manuseio, não será fornecido assistência técnica gratuita.

ADVERTENCIA

Para limpieza de su móvil, use una flanela seca o húmeda, y no utilice productos químicos que puedan dañar su producto.

SISTEMA DE MONTAJE

El sistema de montaje de los productos funciona de acuerdo con el orden creciente de los números indicados en el dibujo. Ej.: 01, 02, 03, 04... hasta la conclusión del montaje.

ASISTENCIA TÉCNICA

Para solicitar Asistencia Técnica, el consumidor debe comunicarse con el Comercio que usted realizó la compra de este producto y solicita asistencia técnica para las partes dañadas. La garantía cubre todas las partes, piezas y componentes que eventualmente puedan presentar defecto de fabricación en el plazo de 03 (tres) meses, contados a partir de la entrega del producto al consumidor, mediante factura de compra. Si se produce algún cambio en la estructura del producto o se produce un defecto por negligencia del montador/consumidor en relación con las instrucciones de montaje y manipulación, no se prestará asistencia técnica gratuita.

NOTICE

To clean your furniture, use a dry or wet cloth, and do not use chemicals that may damage your product.

ASSEMBLY SYSTEM

The products' assembly system works according to the increasing order of the indicated numbers. For example: 01, 02, 03, 04 ... to the end of the assembly.

TECHNICAL ASSISTANCE

To request Technical Assistance, the consumer must contact the retailer from whom you purchased this product and request technical assistance for the damaged parts. The warranty covers all parts, parts and components that may eventually present a manufacturing defect within a period of 03 (three) months, counting from the delivery of the product to the consumer, by means of a purchase invoice. If there is any change in the structure of the product or defect occurs due to negligence of the assembler/consumer in relation to the assembly and handling instruction, free technical assistance will not be provided.

ACESSÓRIOS | ACCESORIOS | ACCESSORIES

A



x4

B



x44

C



x36

D



x9

E

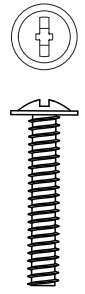

x16

F



x12

G



x120

H



x92

I

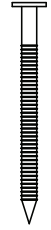

x12

J

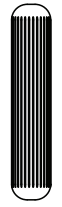

x138

K

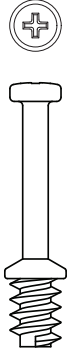

x2

L

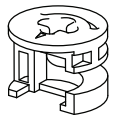

x2

M

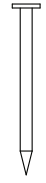

x208

N

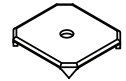

x53

O

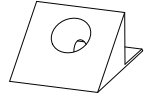

x12

ACESSÓRIOS | ACCESORIOS | ACCESSORIES

P

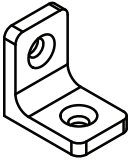

x22

Q



x4

R



x16

S

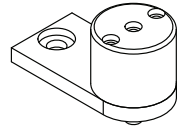

x12

T

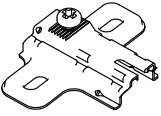

x24

U

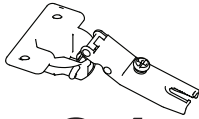

x24

V

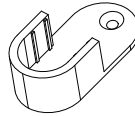

x4

W

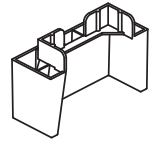

x8

X



x24

Y

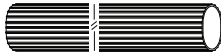

x2

Z



x6 PAR

AA



x3

AB

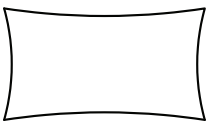

x3

AC

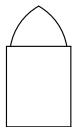

x3

AD

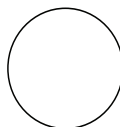

x4

AE



x42

AF

HENN

x1

LISTA DE PEÇAS | LISTA DE PIEZAS | LIST OF PIECES ITM/D309-

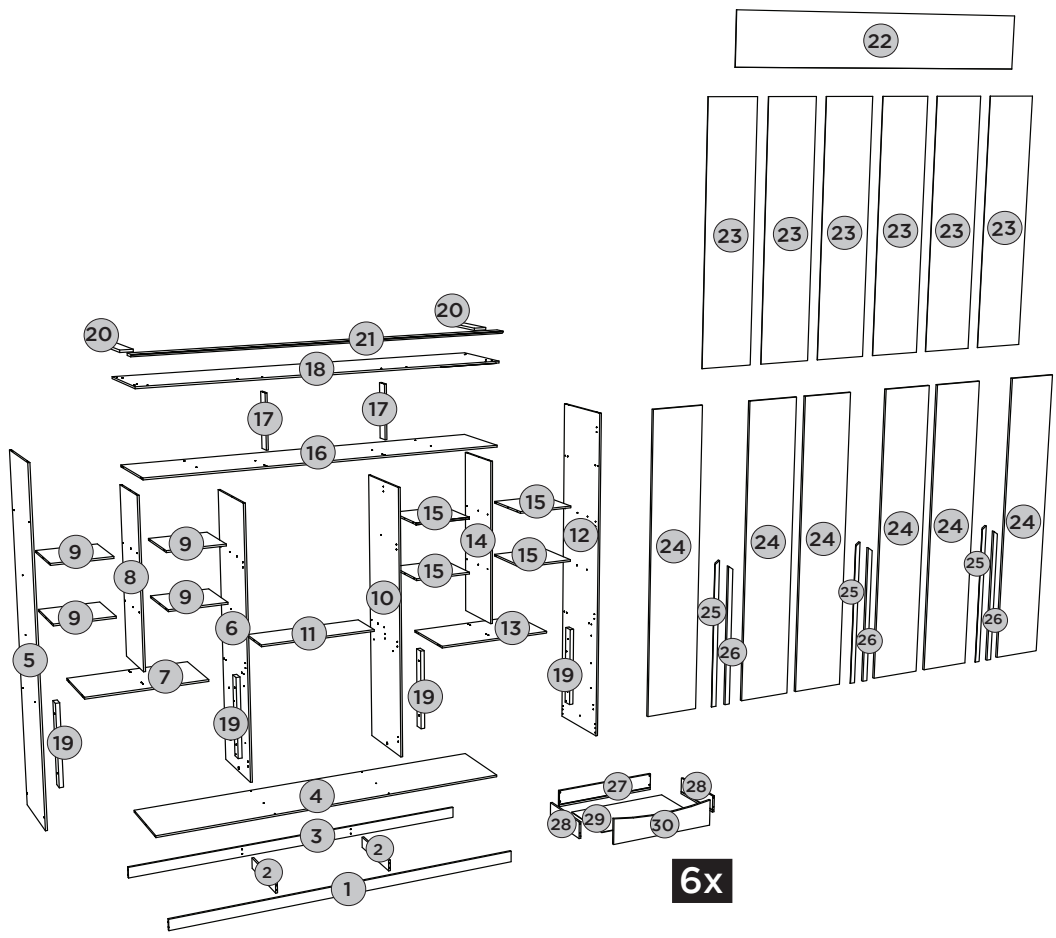

26Item27	Caixa Caja Box	Qty Ctd Qty	Descrição Descripción Description	Dimensões (mm) Dimensiones (mm) Dimensions (mm)		
				Comprimento Largo Length	Largura Ancho Width	Espessura Grosor Thickness
1	2/4	1	RODAPÉ FRONTAL FALDÓN DELANTERO FRONT SKIRTING	2265	73	12
2	2/4	2	TRAVESSA DO RODAPÉ PLACA DE RODAPIÉ SKIRTING PLATE	415	73	12
3	2/4	1	RODAPÉ TRASEIRO REPOSAPIÉS TRASERO BACK FOOTBOARD	2265	73	12
4	2/4	1	BASE BASE BASE	2265	445	12
5	3/4	1	LATERAL ESQUERDA LATERAL IZQUIERDA LEFT SIDE	2223	445	12
6	1/4	1	DIVISÃO ESQUERDA DIVISIÓN IZQUIERDA LEFT DIVISION	1776	445	12
7=13	1/4	1	TAMPO DAS GAVETAS TAPA DE LOS CAJONES TOP OF DRAWERS	747	400	12
8=14	3/4	1	DIVISÃO NICHU DIVISIÓN NICHU NICHE DIVISION	1089	351	12
9=15	3/4	4	PRATELEIRA ESTANTE SHELF	367	350	12
10	1/4	1	DIVISÃO DIREITA DIVISIÓN DERECHA RIGHT DIVISION	1776	445	12
11	1/4	1	PRATELEIRA DO CALCEIRO ESTANTE DE CALCEIRO CALCEIRO'S SHELF	747	250	12
12	3/4	1	LATERAL DIREITA LADO DERECHO RIGHT SIDE	2223	445	12
13=7	1/4	1	TAMPO DAS GAVETAS TAPA DE LOS CAJONES TOP OF DRAWERS	747	400	12
14=8	3/4	1	DIVISÃO NICHU DIVISIÓN NICHU NICHE DIVISION	1089	351	12
15=9	3/4	4	PRATELEIRA ESTANTE SHELF	367	350	12
16	2/4	1	CHÃO DO MALEIRO REPISA SUPERIOR FLOOR OF MALEIRO	2265	445	12
17	3/4	2	RIPA DO MALEIRO TRAVESAÑO SUPERIOR MALEIRO'S LATH	350	73	12
18	2/4	1	TAMPO TAPA TOP	2309	465	12
19	3/4	4	RIPA LATERAL RIPA LATERAL SIDE CLAPBOARD	525	58	25
20	2/4	2	MOLDURA LATERAL MARCO LATERAL LATERAL FRAME	401	80	15
21	2/4	1	MOLDURA FRONTAL SUPERIOR MARCO SUPERIOR DELANTERO UPPER FRONT FRAME	2349	80	15
22	2/4	1	FUNDO SUPERIOR FONDO TOP TOP FUND	2283	367	3
23	3/4 e 4/4	6	FUNDO FONDO BOTTOM	1793	377	3
24	4/4	6	PORTA PUERTA DOOR	2141	377	15
25	2/4	3	APLIQUE MAIOR APLICARSE MÁS GRANDE APPLY BIGGER	1050	40	15
26	2/4	3	APLIQUE MENOR APLICAR MÁS PEQUEÑO APPLY SMALLER	1000	40	15
27	1/4	6	RIPA DE TRÁS MALLA DETRÁS REAR LAHT	677	110	12
28	3/4	12	LADO DE GAVETA LADO DEL CAJÓN SIDE OF DRAWER	350	110	12
29	2/4	6	FUNDO DE GAVETA RECORTADO FONDO DE CAJÓN RECORTADO RECORTADO DRAWER BOTTOM	664	361	3
30	1/4	6	FRENTE DE GAVETA FRENTE DE CAJÓN FRONT OF DRAWER	689	170	12



PEÇAS REQUERIDAS

1	RODAPÉ FRONTAL	x1
2	TRAVESSA DO RODAPÉ	x2
3	RODAPÉ TRASEIRO	x1
17	RIPA DO MALEIRO	x2

ACESSÓRIOS REQUERIDOS

G		04
J		20
P		04

FERRAMENTAS NECESSÁRIAS

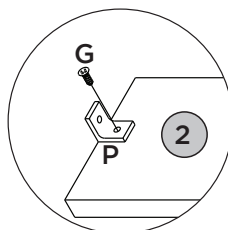
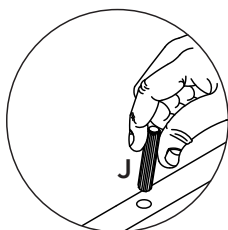
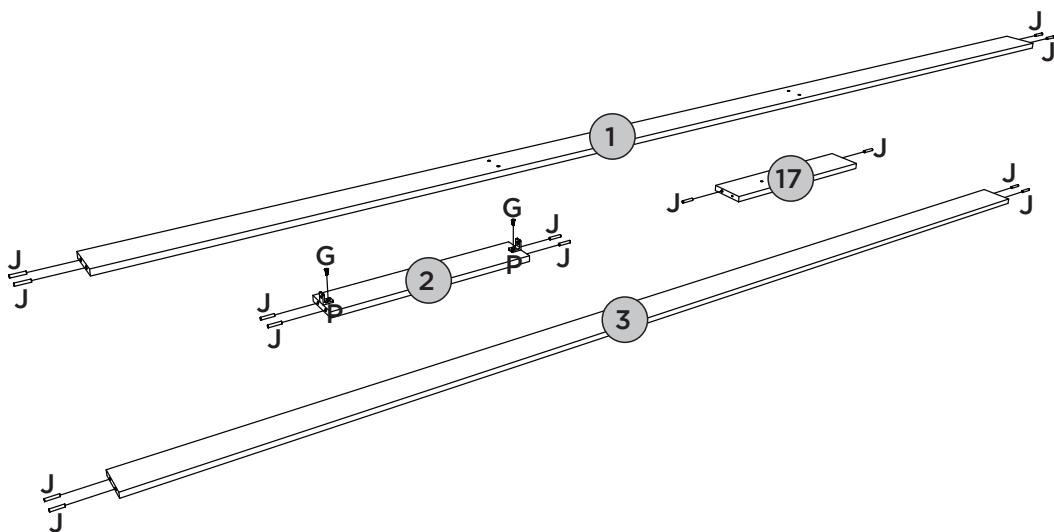
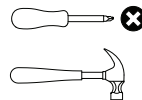

PEÇAS REQUERIDAS

4	BASE	x1
5	LATERAL ESQUERDA	x1
6	DIVISÃO ESQUERDA	x1

ACESSÓRIOS REQUERIDOS

G		14
H		04
J		08
K		02
Q		04
S		06
T		04
V		02

FERRAMENTAS NECESSÁRIAS

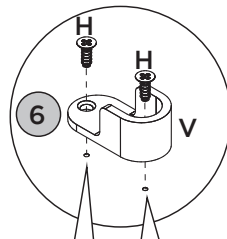
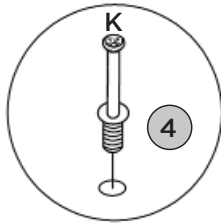
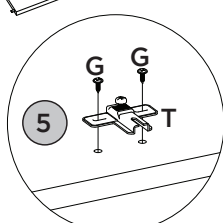
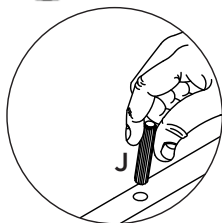
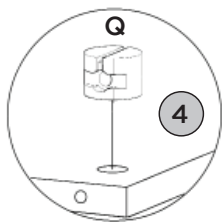
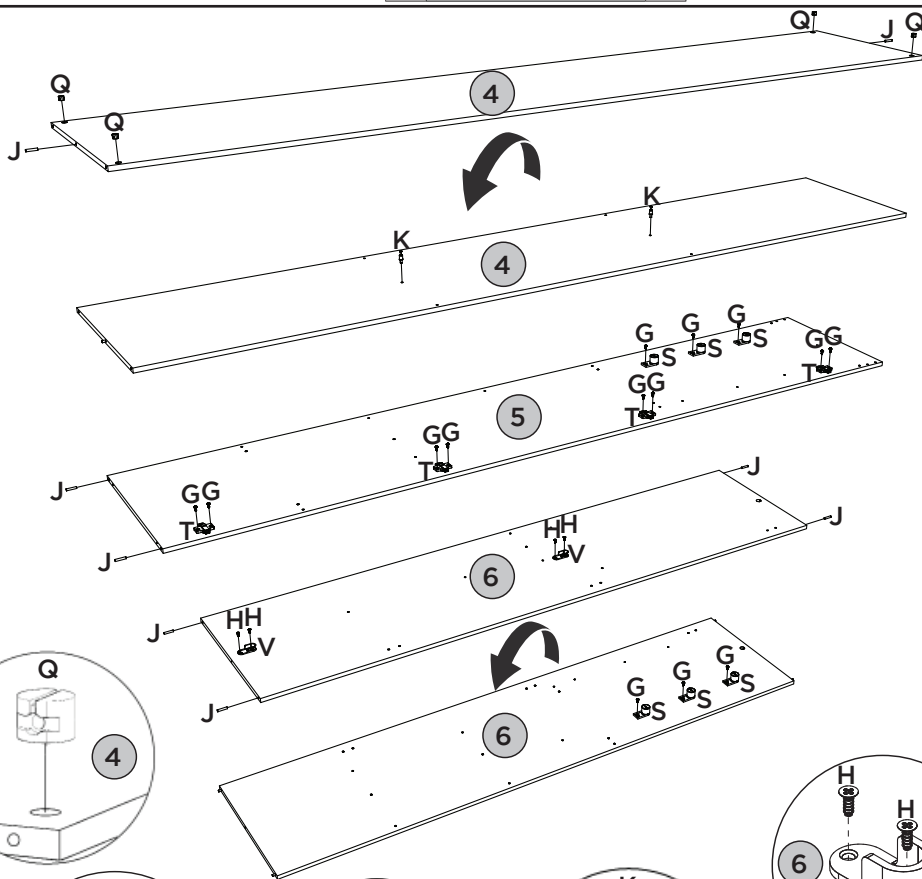
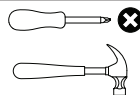

**Observe:
Furos
pré-marcados**

PEÇAS REQUERIDAS

7=13	TAMPO DAS GAVETAS	x2
8=14	DIVISÃO NICHOS	x2
9=15	PRATELEIRA	x8
11	PRATELEIRA DO CALCEIRO	x1

ACESSÓRIOS REQUERIDOS

J		52
---	---	----

FERRAMENTAS NECESSÁRIAS

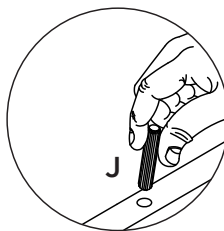
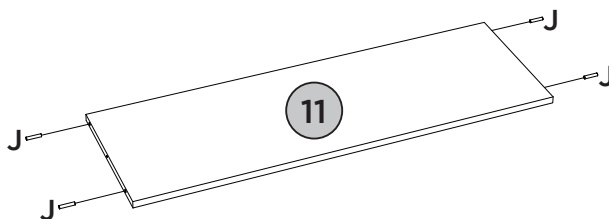
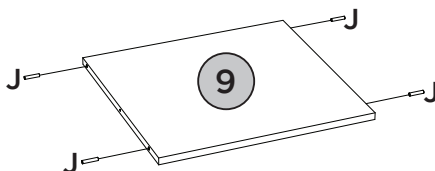
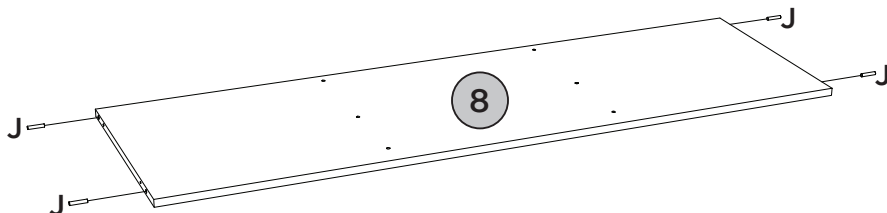
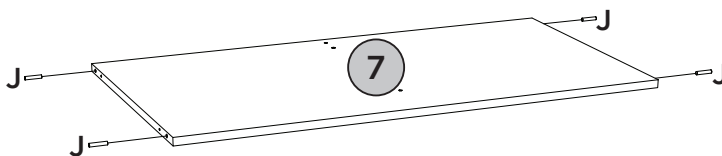
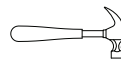







PASSO 4

ITM/D309-

PEÇAS REQUERIDAS

10	DIVISÃO DIREITA	x1
12	LATERAL DIREITA	x1
16	CHÃO DO MALEIRO	x1

ACESSÓRIOS REQUERIDOS

G		14
H		04
J		10
S		06
T		04
V		02

FERRAMENTAS NECESSÁRIAS

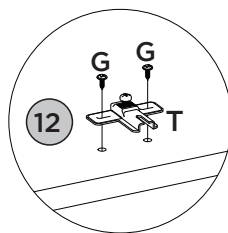
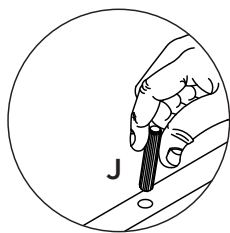
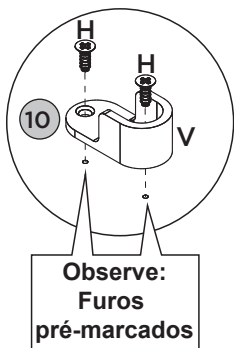
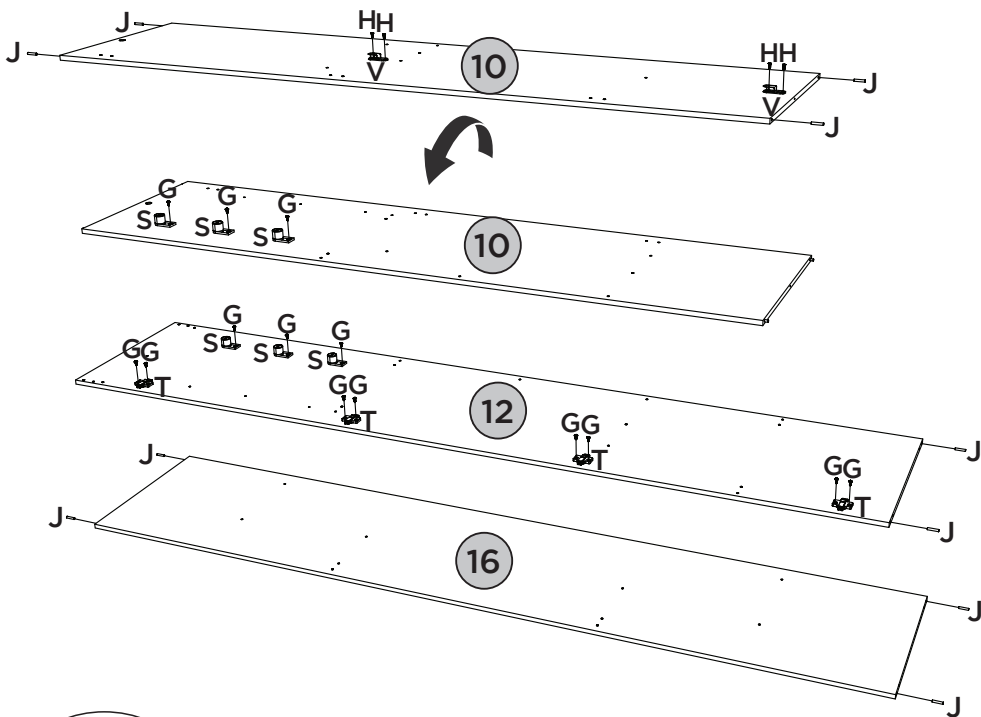
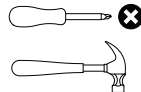

PASSO 5

ITM/D309-

PEÇAS REQUERIDAS

1	RODAPÉ FRONTAL	x1
2	TRAVESSA DO RODAPÉ	x2
3	RODAPÉ TRASEIRO	x1

ACESSÓRIOS REQUERIDOS



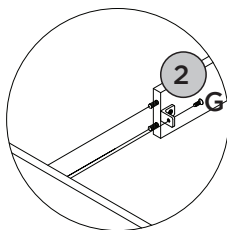
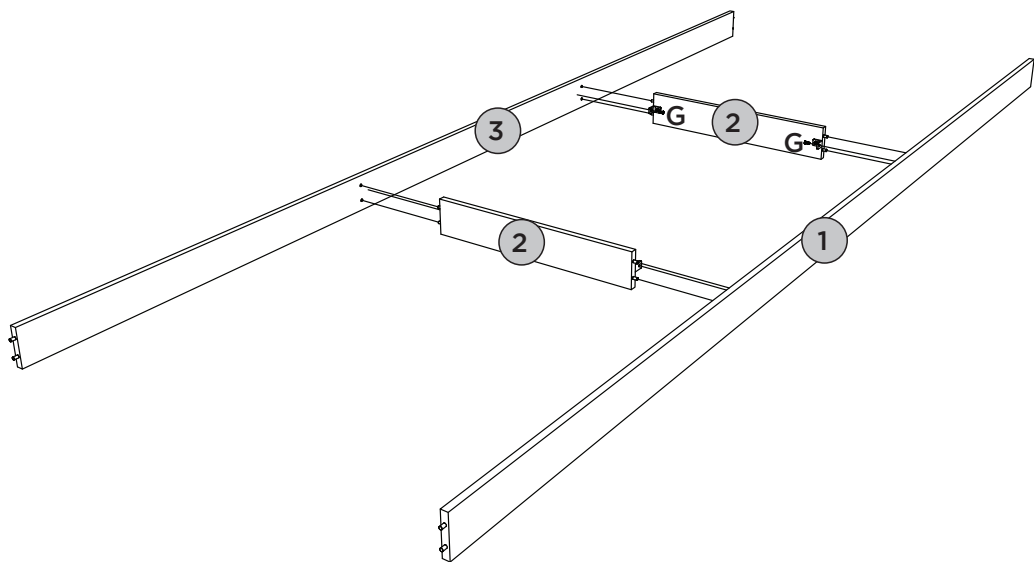
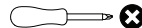

FERRAMENTAS NECESSÁRIAS



PEÇAS REQUERIDAS

4	BASE	x1
---	------	----

ACESSÓRIOS REQUERIDOS

G		36
P		06
W		08

FERRAMENTAS NECESSÁRIAS

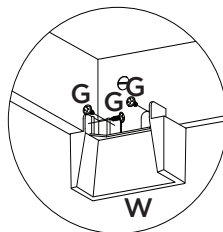
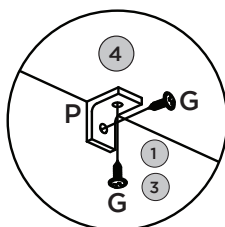
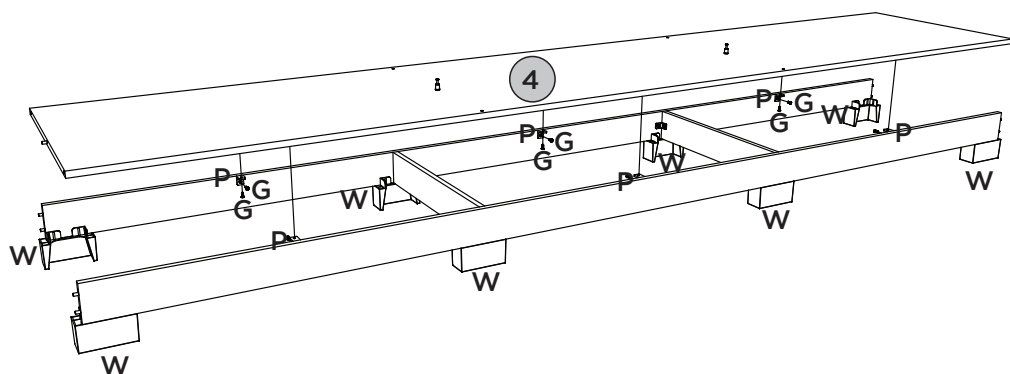
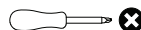

PEÇAS REQUERIDAS

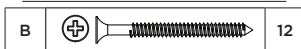
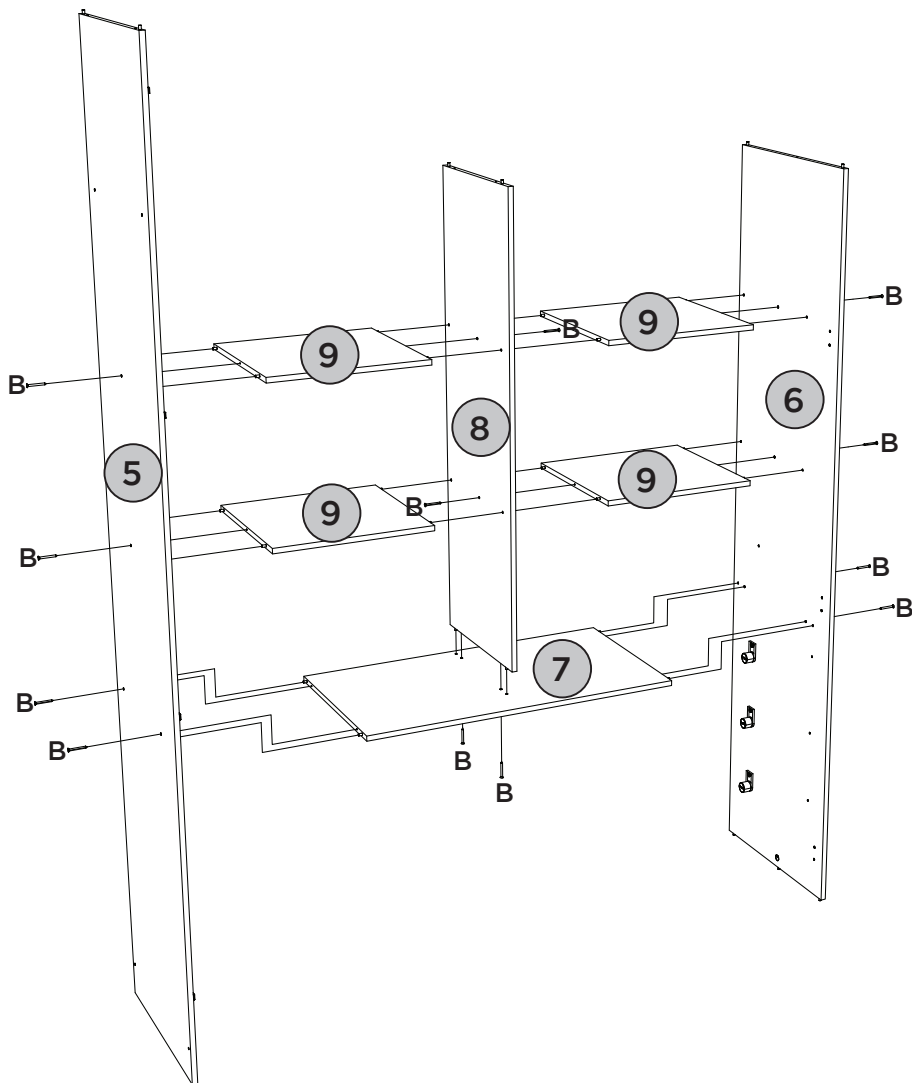
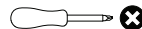

5	LATERAL ESQUERDA	x1
6	DIVISÃO ESQUERDA	x1
7	TAMPO DAS GAVETAS	x1
8	DIVISÃO NICHOS	x1
9	PRATELEIRA	x4

ACESSÓRIOS REQUERIDOS

FERRAMENTAS NECESSÁRIAS

PEÇAS REQUERIDAS

10	DIVISÃO DIREITA	x1
11	PRATELEIRA DO CALCEIRO	x1

ACESSÓRIOS REQUERIDOS

A		02
B		02
L		02



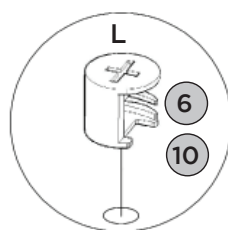
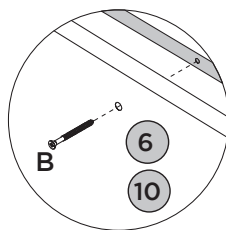
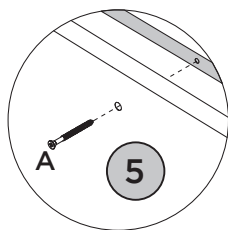
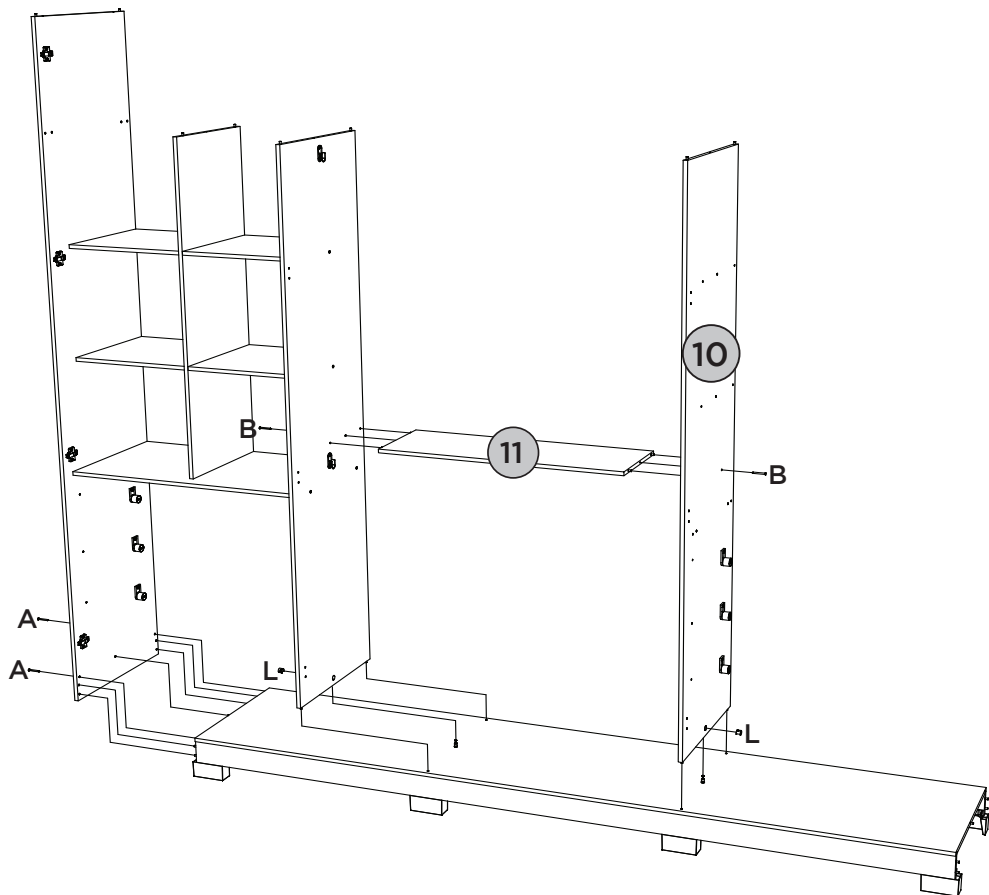
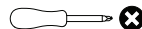

FERRAMENTAS NECESSÁRIAS



PEÇAS REQUERIDAS

12	LATERAL DIREITA	x1
13	TAMPO DAS GAVETAS	x1
14	DIVISÃO NICHOS	x1
15	PRATELEIRA	x4
16	CHÃO DO MALEIRO	x1
17	RIPA DO MALEIRO	x2

ACESSÓRIOS REQUERIDOS

A			02
B			24

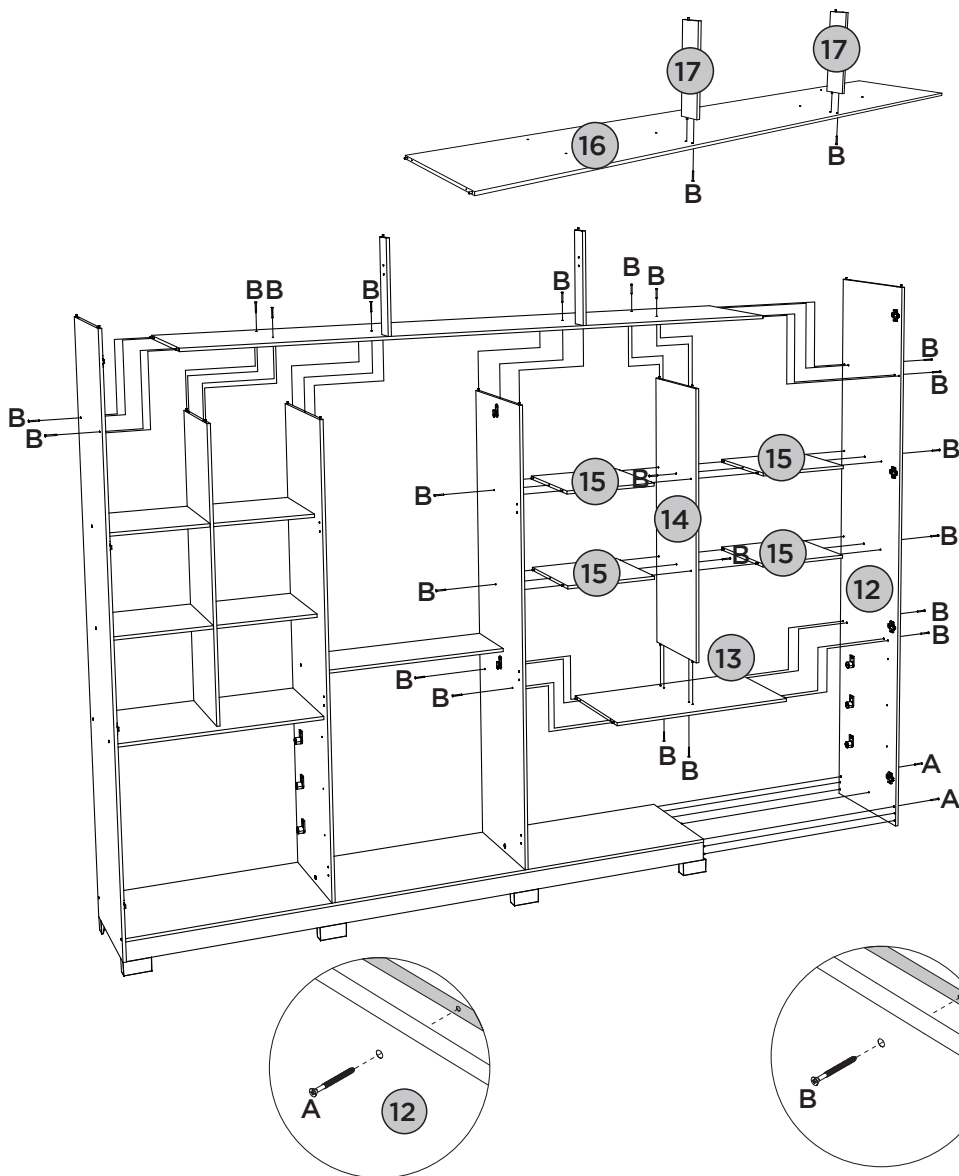
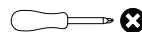

FERRAMENTAS NECESSÁRIAS



PEÇAS REQUERIDAS

18	TAMPO	
19	RIPA LATERAL	

ACESSÓRIOS REQUERIDOS

B		06
C		12



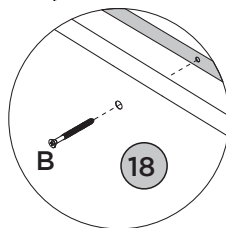
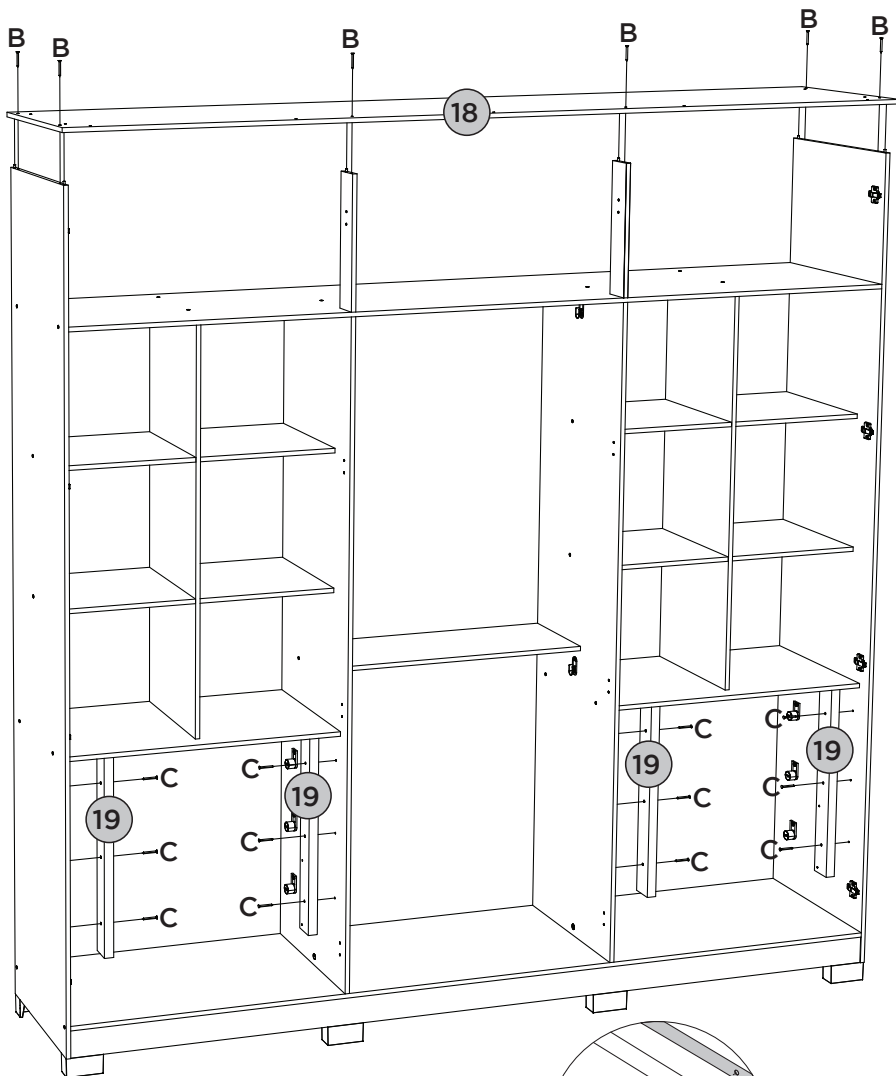
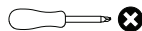



FERRAMENTAS NECESSÁRIAS



PEÇAS REQUERIDAS

20	MOLDURA LATERAL	x2
21	MOLDURA FRONTAL SUPERIOR	x1

ACESSÓRIOS REQUERIDOS

D		09
E		16
H		24
R		16
T		16
Z		06

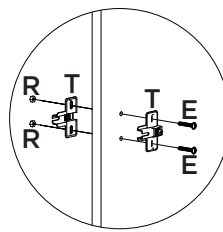
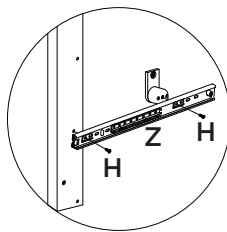
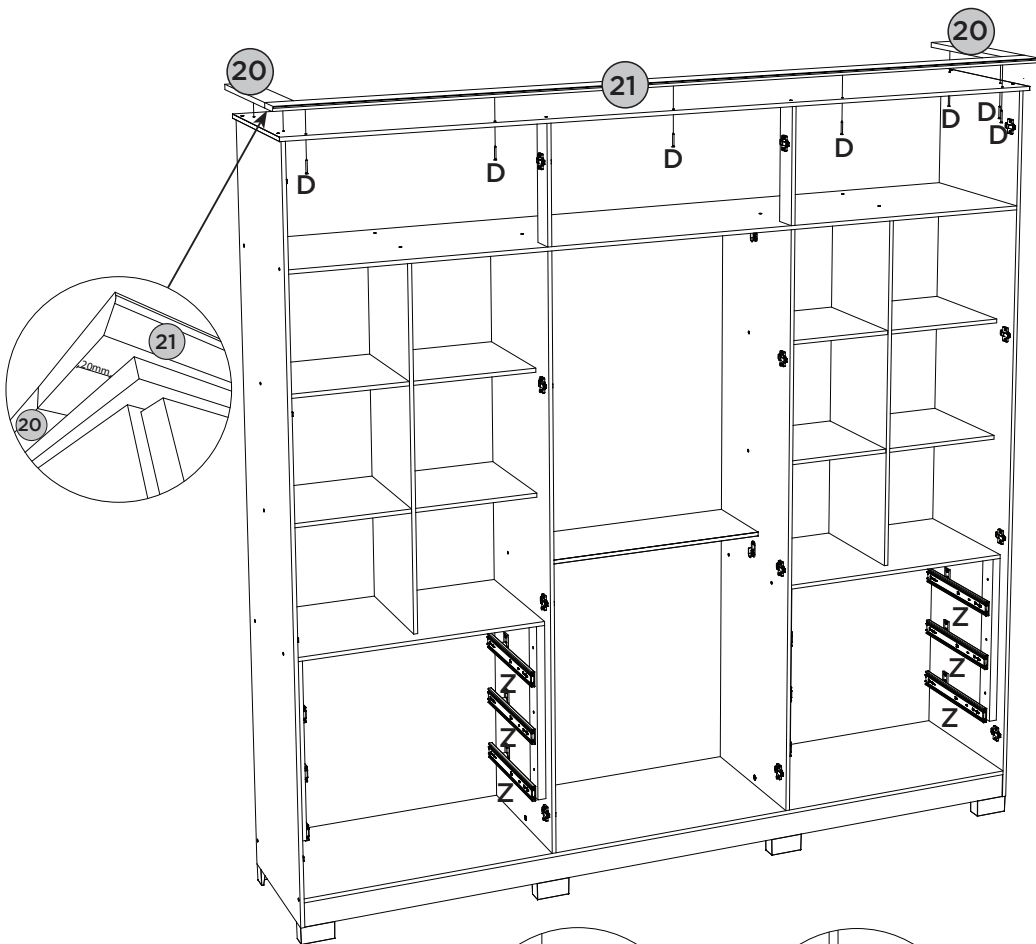
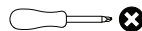

FERRAMENTAS NECESSÁRIAS



PEÇAS REQUERIDAS

22	FUNDO SUPERIOR	x1
23	FUNDO	x6

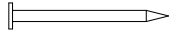
ACESSÓRIOS REQUERIDOS

M		208
N		53
AA		03

FERRAMENTAS NECESSÁRIAS

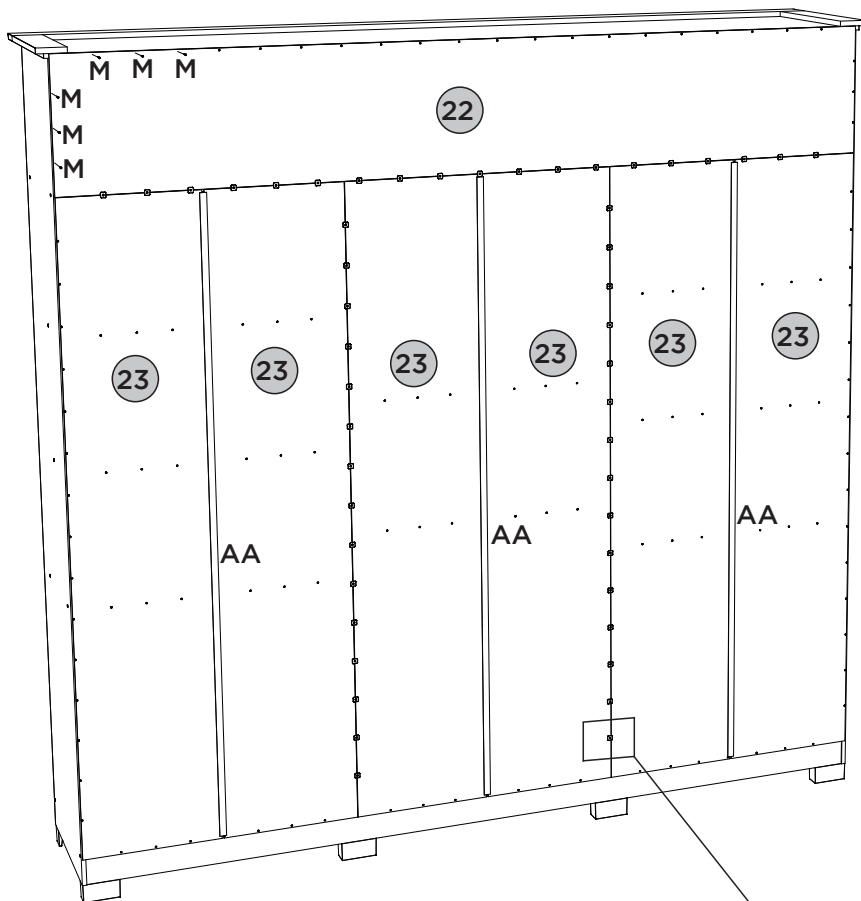
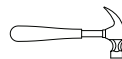

Fixar os pregos a uma distância de 100mm de um para outro.

Fijar las uñas a un distancia de 100mm uno a otro.



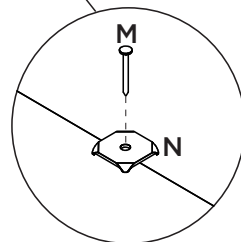





Fix the nails at a distance of 100mm from one to the other



PEÇAS REQUERIDAS

24	PORTA	x6
25	APLIQUE MAIOR	x3
26	APLIQUE MENOR	x3

ACESSÓRIOS REQUERIDOS

C			24
G			48
U			24
X			24

FERRAMENTAS NECESSÁRIAS

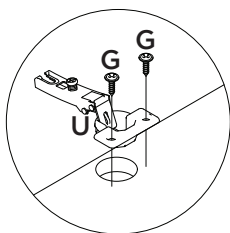
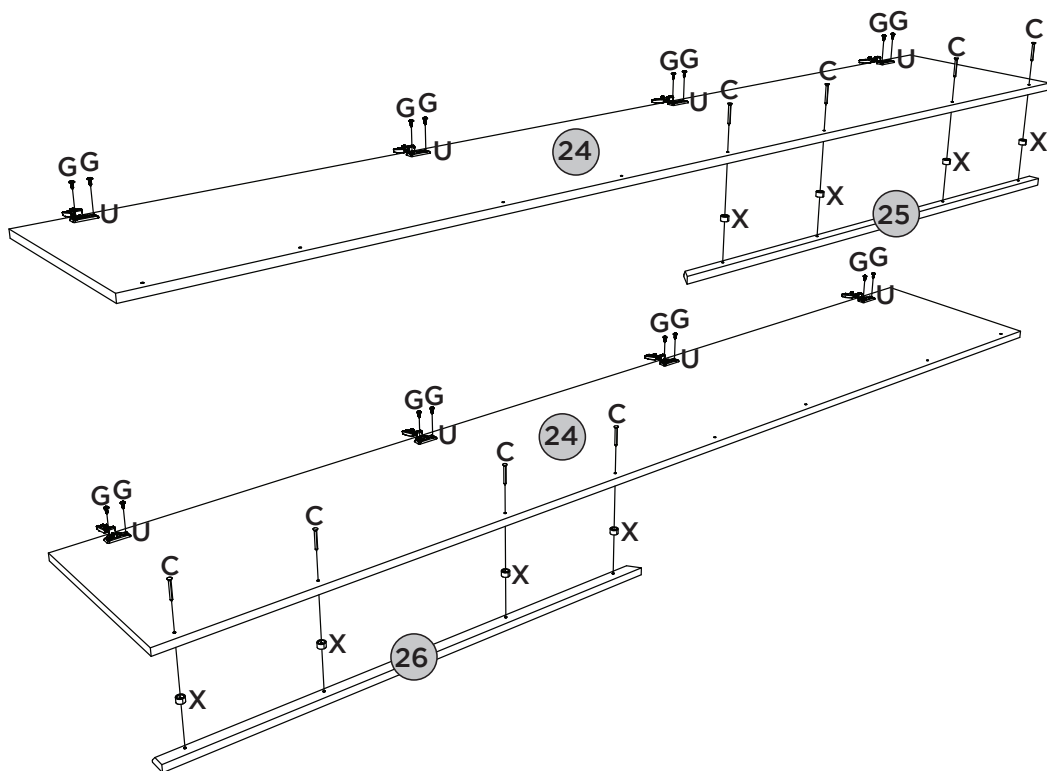
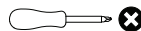

Vídeo: Instalar e regular Dobradiças

Video: Instale y ajuste las bisagras

Video: Install and adjust hinges

PEÇAS REQUERIDAS

24	PORTA	x6
----	-------	----

ACESSÓRIOS REQUERIDOS

Y		02
---	---	----

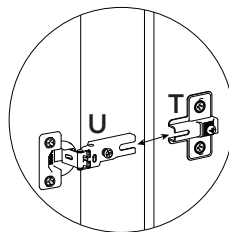
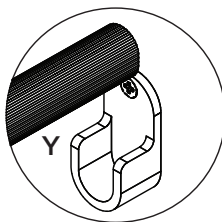
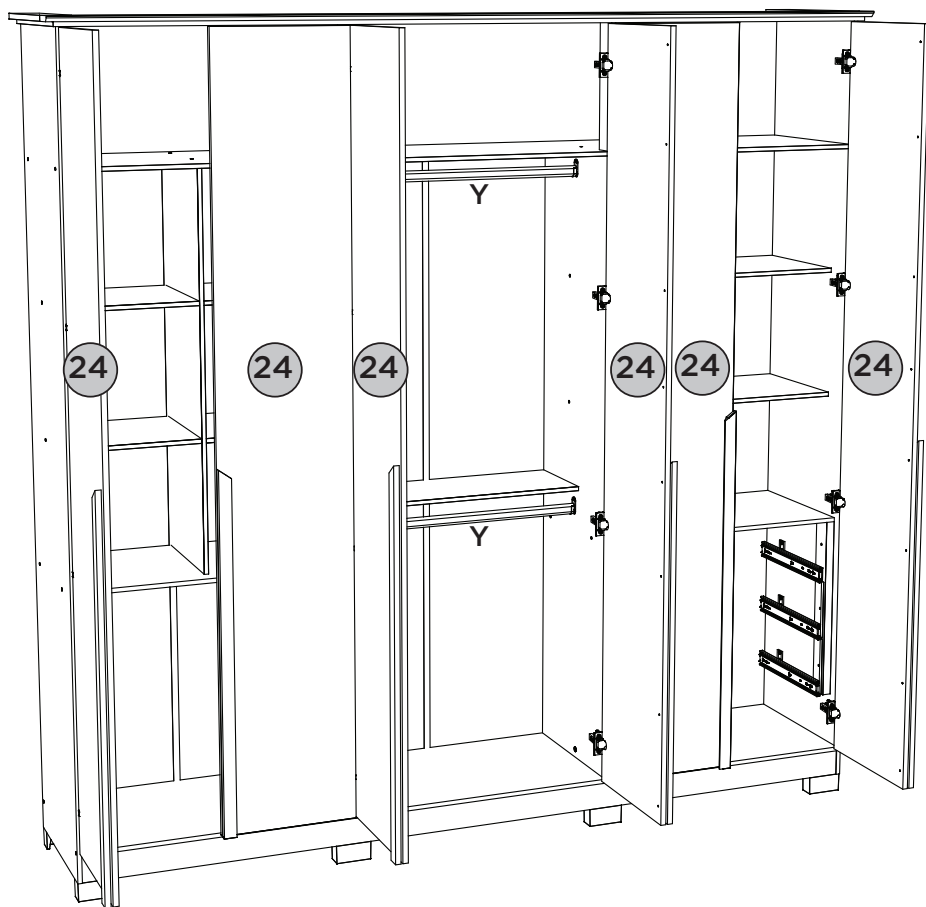



PASSO 15

ITM/D309-

PEÇAS REQUERIDAS

28	LADO DE GAVETA	x12
----	----------------	-----

ACESSÓRIOS REQUERIDOS

J		48
AB		

FERRAMENTAS NECESSÁRIAS

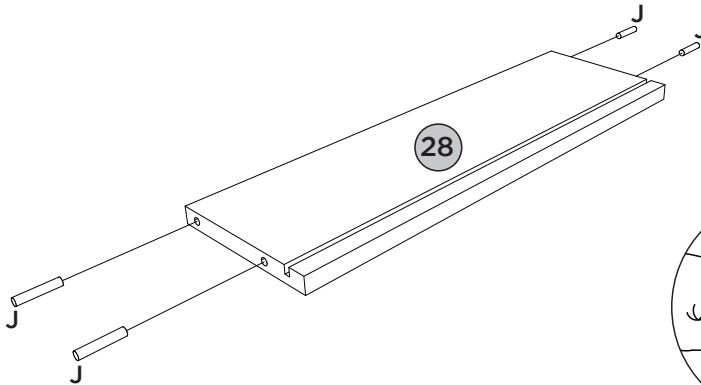
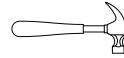

PASSO 16

PEÇAS REQUERIDAS

27	RIPA DE TRÁS	x6
28	LADO DE GAVETA	x12

ACESSÓRIOS REQUERIDOS

AB		
----	---	--

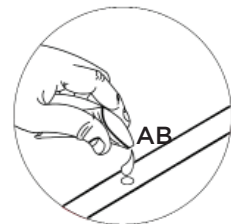
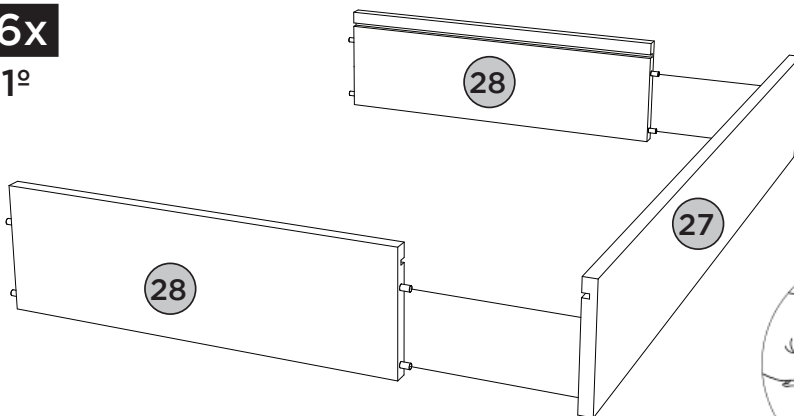

6x
1º



PEÇAS REQUERIDAS



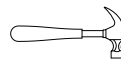
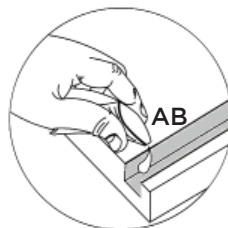
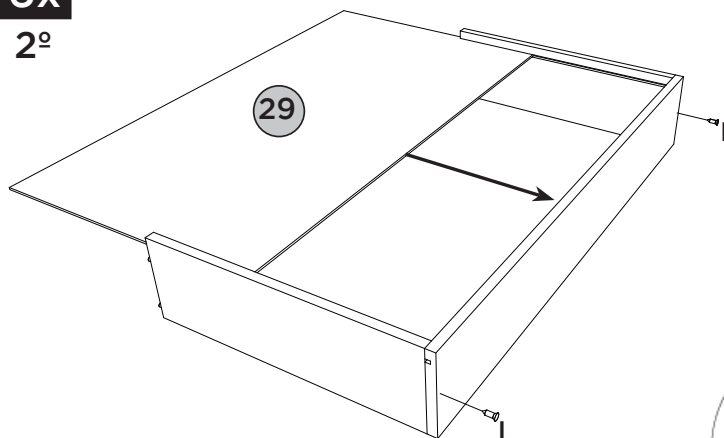
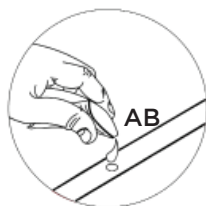
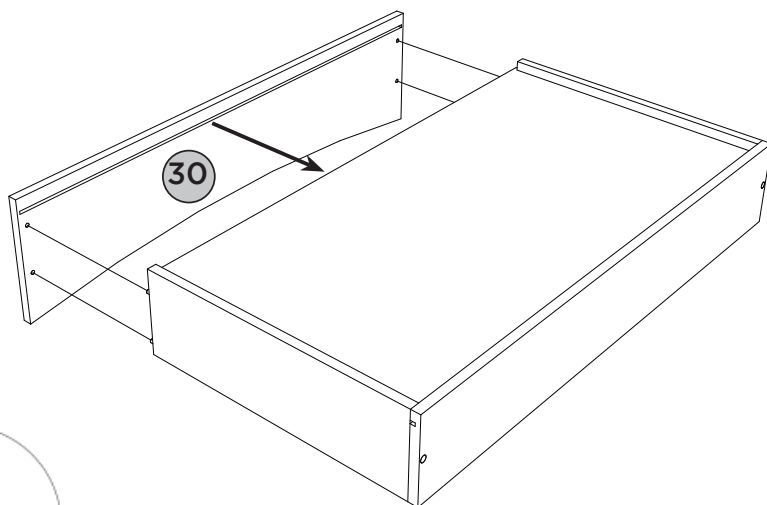

29	FUNDO DE GAVETA RECORTADO	x6
30	FRENTE DE GAVETA	x6

ACESSÓRIOS REQUERIDOS

I		12
AB		

FERRAMENTAS NECESSARIAS

6x
2º

6x
3º

ACESSÓRIOS REQUERIDOS

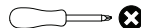
F		12
H		60
O		12
P		12
Z		06

FERRAMENTAS NECESSÁRIAS



6x

4º

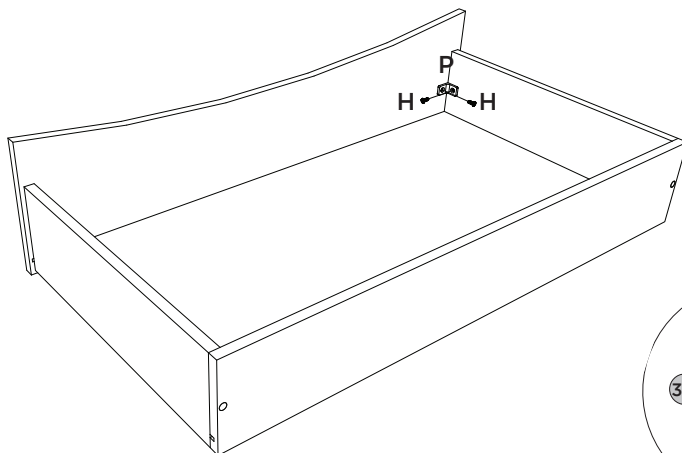

Deixar 3mm de distância da frente de gaveta.

Deje una separación de 3mm del frente del cajón.



Leave 3mm away from the front of the drawer.

6x

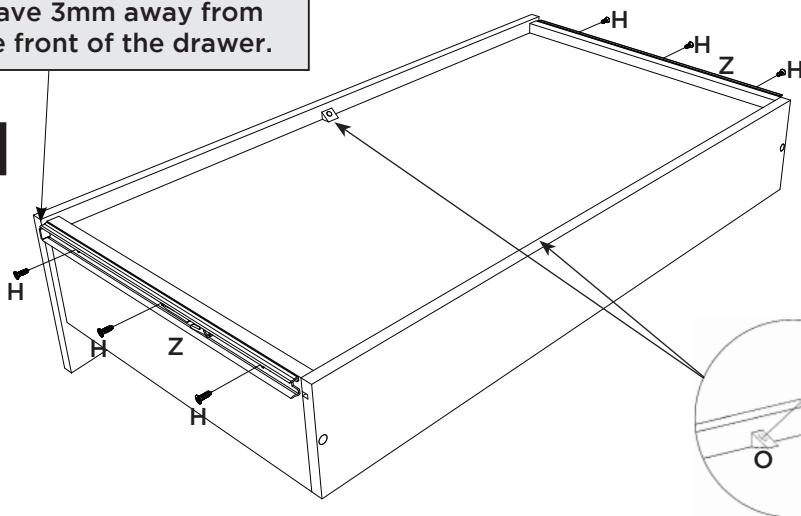
5º



ACESSÓRIOS REQUERIDOS

AC		03
AD		04
AE		42
AF	HENN	01

Pesos máximos recomendados com carga distribuída
 Peso máximo recomendado con la carga distribuida
 Recommended maximum weight with distributed load.

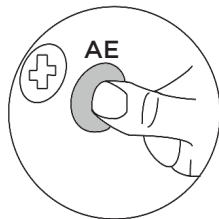
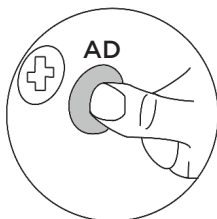
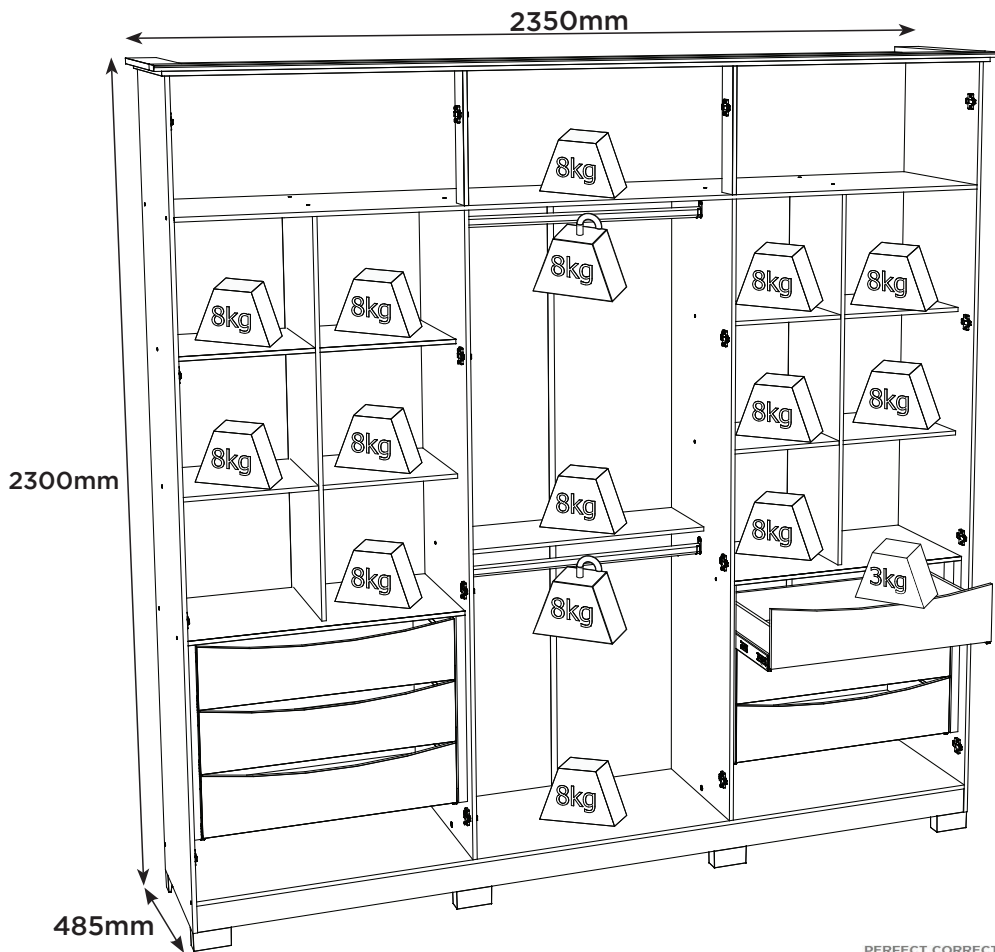

PERFECT CORRECTION
 CORRECCIÓN PERFECTA

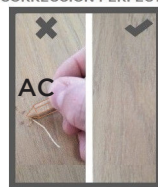

Produto Concluído
Producto terminado
Finished Product

