

HENNInd. e Com. de Móveis Henn
Mondai - SC - Brasil

☎ +55 49 3674.3500

📱 @moveishenn
www.henn.com.br**INSTRUÇÕES DE
MONTAGEM****INSTRUCCIONES DE MONTAJE
ASSEMBLY INSTRUCTIONS****Roupeiro Vicenza 2 Portas Deslizantes | Vicenza Armario 2 Puertas
Correderas | Vicenza Wardrobe 2 Sliding Doors**

D313-127 Nature/Off White

D313-131 Cinza

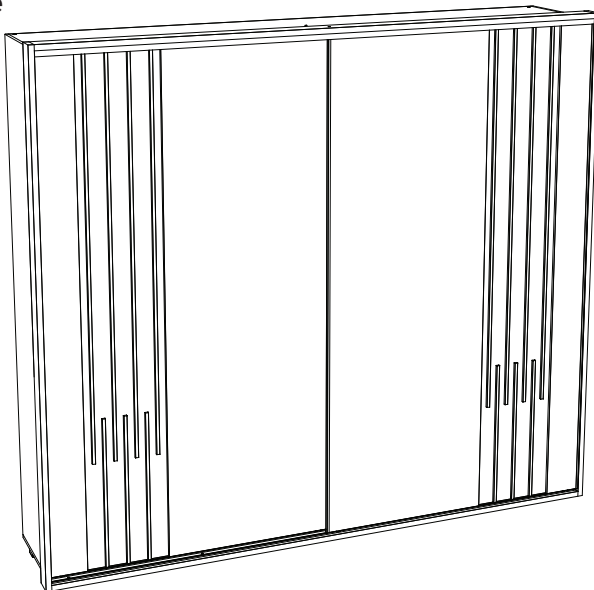
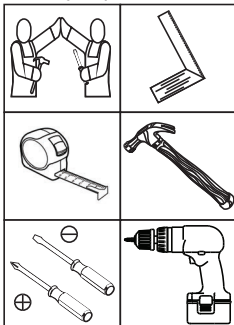
**Requisitos para montagem
Assembly Requirements**

Imagens meramente ilustrativas,
não acompanha o produto.
Imágenes ilustrativas, no incluidas
con el producto.
Illustrative images, not included
with the product.

AVISO

Para limpeza de seu móvel, use uma flanela seca ou umedecida, e não utilize produtos químicos que possam danificar seu produto.

SISTEMA DE MONTAGEM

O sistema de montagem dos produtos, funciona de acordo com a ordem crescente dos números indicados no desenho. Ex: 01, 02, 03, 04... até a conclusão da montagem.

ASSISTÊNCIA TÉCNICA

Para solicitação de Assistência Técnica você consumidor deverá entrar em contato com o Lojista o qual você realizou a compra deste produto e solicitar a assistência técnica das peças avariadas. A garantia abrange todas as peças, partes e componentes que eventualmente venham apresentar defeito de fabricação no prazo de 03 (três) meses, contando a partir da entrega do produto ao consumidor, mediante nota fiscal de compra. Se houver qualquer alteração na estrutura do produto ou ocorrer defeito por negligência do montador/consumidor em relação a instrução de montagem e manuseio, não será fornecido assistência técnica gratuita.

ADVERTENCIA

Para limpeza de su móvil, use una flanela seca o húmeda, y no utilice productos químicos que puedan dañar su producto.

SISTEMA DE MONTAJE

El sistema de montaje de los productos funciona de acuerdo con el orden creciente de los números indicados en el dibujo. Ej.: 01, 02, 03, 04... hasta la conclusión del montaje.

ASISTENCIA TÉCNICA

Para solicitar Asistencia Técnica, el consumidor debe comunicarse con el Comercio que usted realizó la compra de este producto y solicita asistencia técnica para las partes dañadas. La garantía cubre todas las partes, piezas y componentes que eventualmente puedan presentar defecto de fabricación en el plazo de 03 (tres) meses, contados a partir de la entrega del producto al consumidor, mediante factura de compra. Si se produce algún cambio en la estructura del producto o se produce un defecto por negligencia del montador/consumidor en relación con las instrucciones de montaje y manipulación, no se prestará asistencia técnica gratuita.

NOTICE

To clean your furniture, use a dry or wet cloth, and do not use chemicals that may damage your product.

ASSEMBLY SYSTEM

The products' assembly system works according to the increasing order of the indicated numbers. For example: 01, 02, 03, 04 ... to the end of the assembly.

TECHNICAL ASSISTANCE

To request Technical Assistance, the consumer must contact the retailer from whom you purchased this product and request technical assistance for the damaged parts. The warranty covers all parts, parts and components that may eventually present a manufacturing defect within a period of 03 (three) months, counting from the delivery of the product to the consumer, by means of a purchase invoice. If there is any change in the structure of the product or defect occurs due to negligence of the assembler/consumer in relation to the assembly and handling instruction, free technical assistance will not be provided.

ACESSÓRIOS | ACCESORIOS | ACCESSORIES

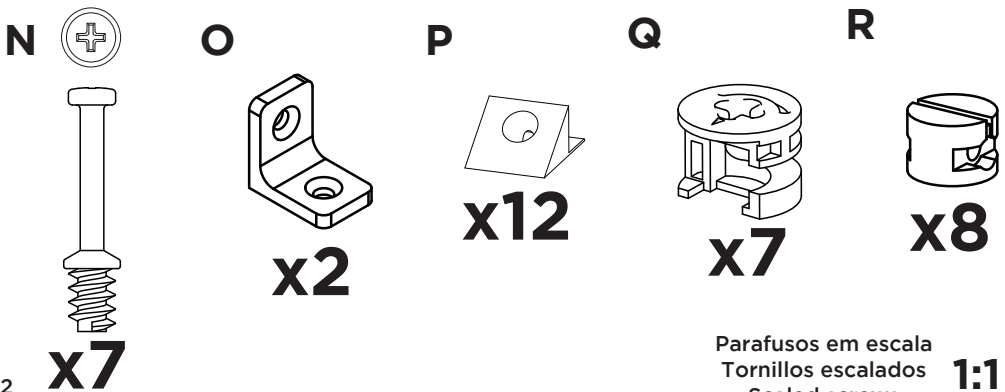
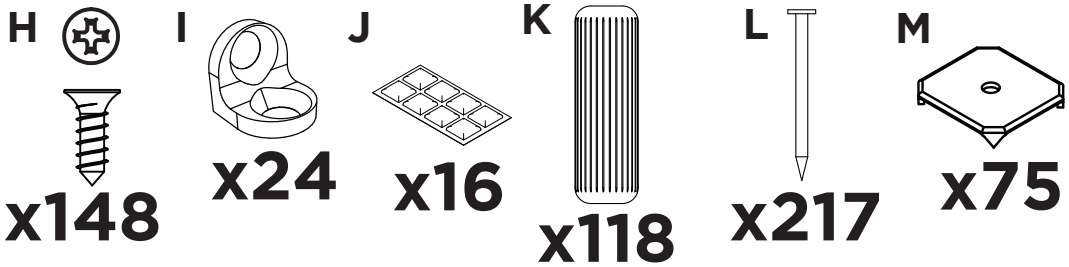
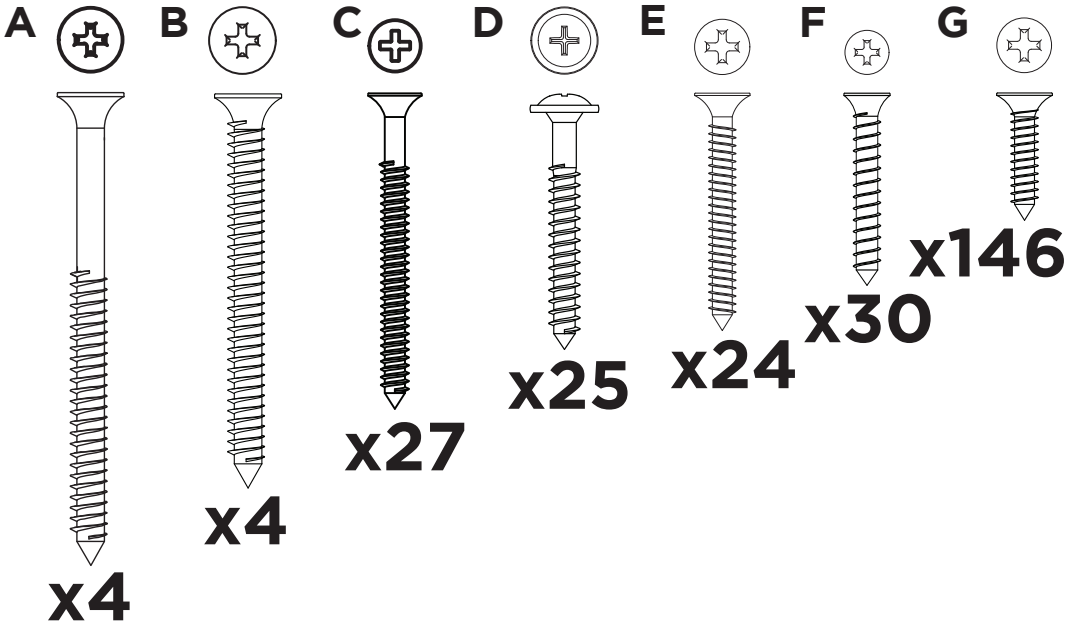

Parafusos em escala
Tornillos escalados
Scaled screws **1:1**

ACESSÓRIOS | ACCESORIOS | ACCESSORIES

S

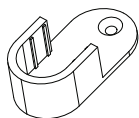

x6

T

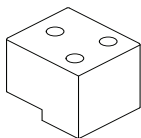

x10

U

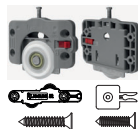

x1 KIT

V

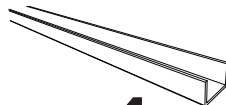

x4

W

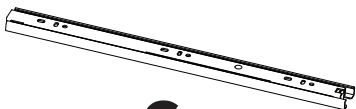

x6 PAR

X



x3

Y



x4

Z



x1

AA



x1

AB

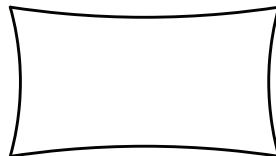

x3

AC

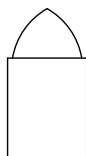

x2

AD

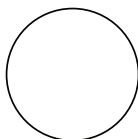

x7

AE

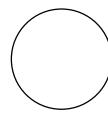

x20

AF

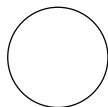

x50

AG



x1

LISTA DE PEÇAS | LISTA DE PIEZAS | LIST OF PIECES

Item	Caixa Caja Box	Qtd Ctd Qty	Descrição Descripción Description	Dimensões (mm) Dimensiones (mm) Dimensions (mm)		
				Comprimento Largo Length	Largura Ancho Width	Espesura Grosor Thickness
1	2/5	01	BASE BASE BASE	2573	470	15
2	3/5	02	TRAVESSA LATERAL BASE CARRIL LATERAL BASE BASE SIDE CROSSBAR	450	90	15
3	3/5	03	TRAVESSA CENTRAL BASE CARRIL CENTRAL BASE CENTRAL BASE RAIL	450	70	15
4	2/5	01	TRAVESSA FRONTAL BASE CARRIL DELANTERA DE LA BASE BASE FRONT CROSSBAR	2603	90	25
5	1/5	02	TAMPO DAS GAVETAS TAPA DE LOS CAJONES DRAWER TOP	647	400	15
6	1/5	01	DIVISÃO ESQUERDA MENOR DIVISIÓN IZQUIERDA MENOR MINOR LEFT DIVISION	985	355	15
7	1/5	01	DIVISÃO DIREITA MENOR DIVISION DE DERECHO MENOR MINOR RIGHT DIVISION	985	355	15
8	3/5	01	LATERAL ESQUERDA LATERAL IZQUIERDA LEFT SIDE	2300	470	15
9	4/5	01	DIVISÃO GAVETA ESQUERDA DIVISIÓN DEL CAJÓN IZQUIERDO LEFT DRAWER DIVISION	841	400	15
10=14=16	4/5	02	PRATELEIRA ESTANTE SHELF	632	350	15
11	4/5	01	DIVISÃO CENTRAL DIVISIÓN CENTRAL CENTRAL DIVISION	1841	450	15
12	4/5	01	PRATELEIRA DO CALCEIRO ESTANTE DE CALCEIRO CALCEIRO'S SHELF	632	250	15
13	4/5	01	DIVISÃO GAVETA DIREITA DIVISIÓN DEL CAJÓN DERECHO RIGHT DRAWER DIVISION	841	400	15
14=10=16	4/5	01	PRATELEIRA ESTANTE SHELF	632	350	15
15	3/5	01	LATERAL DIREITA LATERAL DERECHA RIGHT SIDE	2300	470	15
16=10=14	4/5	02	PRATELEIRA ESTANTE SHELF	632	350	15
17	3/5	01	CHÃO DO MALEIRO PISO DEL PORTA EQUIPAJES FLOOR OF THE CLOSET TOP SHELF	2573	450	15
18	3/5	01	RIPA DO MALEIRO LISTÓN DAL AMRMARIO DE EQUIPAJE CLAP-BOAR LUGGAGE	414	73	15
19	2/5	01	TAMPO SUPERIOR TAPA SUPERIOR TOP PANEL	2573	470	15
20	2/5	01	FUNDO SUPERIOR FONDO SUPERIOR SUPERIOR BACKGROUND	2579	436	3
21	3/5 e 4/5	08	FUNDO FONDO BOTTOM	1863	321	3
22	2/5	02	MOLDURA LATERAL MARCO LATERAL SIDE FRAME	2350	90	25
23	2/5	02	MOLDURA SUPERIOR MARCO SUPERIOR UPPER FRAME	2603	90	25
24	5/5	02	PAINEL MENOR PANEL PEQUEÑO SMALL PANEL	2268	170	12
25	5/5	02	PAINEL COM APLIQUE PANEL CON ALIQUE PANEL WITH APPLIQUE	2268	490	9
26	2/5	08	MOLDURA 1780MM MARCO 1780MM FRAME 1780MM	1780	15	9
27	2/5	06	MOLDURA 680MM MARCO 680MM FRAME 680MM	680	15	9
28	5/5	02	PAINEL MAIOR PANEL MÁS GRANDE BIGGER PANEL	2268	780	12
29	4/5	06	RIPA DE TRÁS MALLA DETRÁS REAR LATH	607	180	15
30	1/5	12	LADO DE GAVETA LADO DEL CAJÓN SIDE OF DRAWER	350	180	15
31	4/5	06	FUNDO DE GAVETA RECORTADO FONDO DEL CAJÓN RECORTADO CROPPED DRAWER BOTTOM	588	361	3
32	3/5	06	FRENTE DE GAVETA FRENTE DE CAJÓN FRONT OF DRAWER	624	192	15

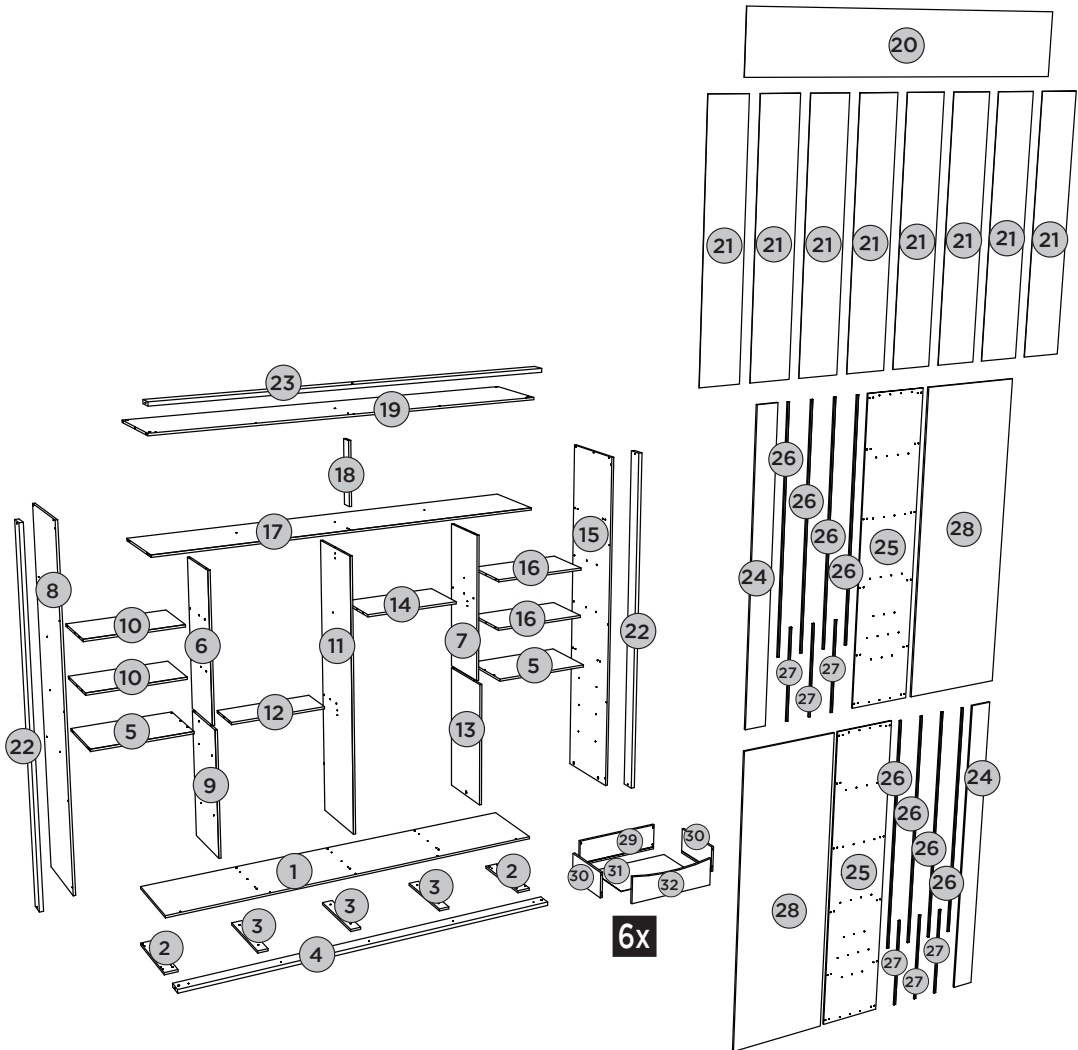

LISTA DE PEÇAS | LISTA DE PIEZAS | LIST OF PIECES



PEÇAS REQUERIDAS

1	BASE	x1
2	TRAVESSA LATERAL BASE	x2
4	TRAVESSA FRONTAL BASE	x1
17	CHÃO DO MALEIRO	x1
18	RIPA DO MALEIRO	x1
19	TAMPO SUPERIOR	x1
23	MOLDURA SUPERIOR	x1

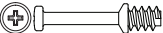
ACESSÓRIOS REQUERIDOS

K		08
N		07
R		08

FERRAMENTAS NECESSÁRIAS

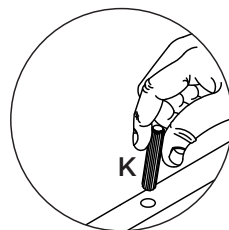
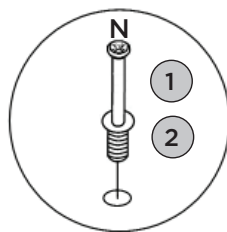
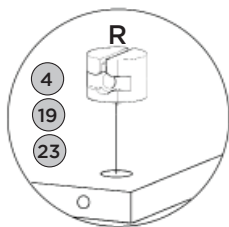
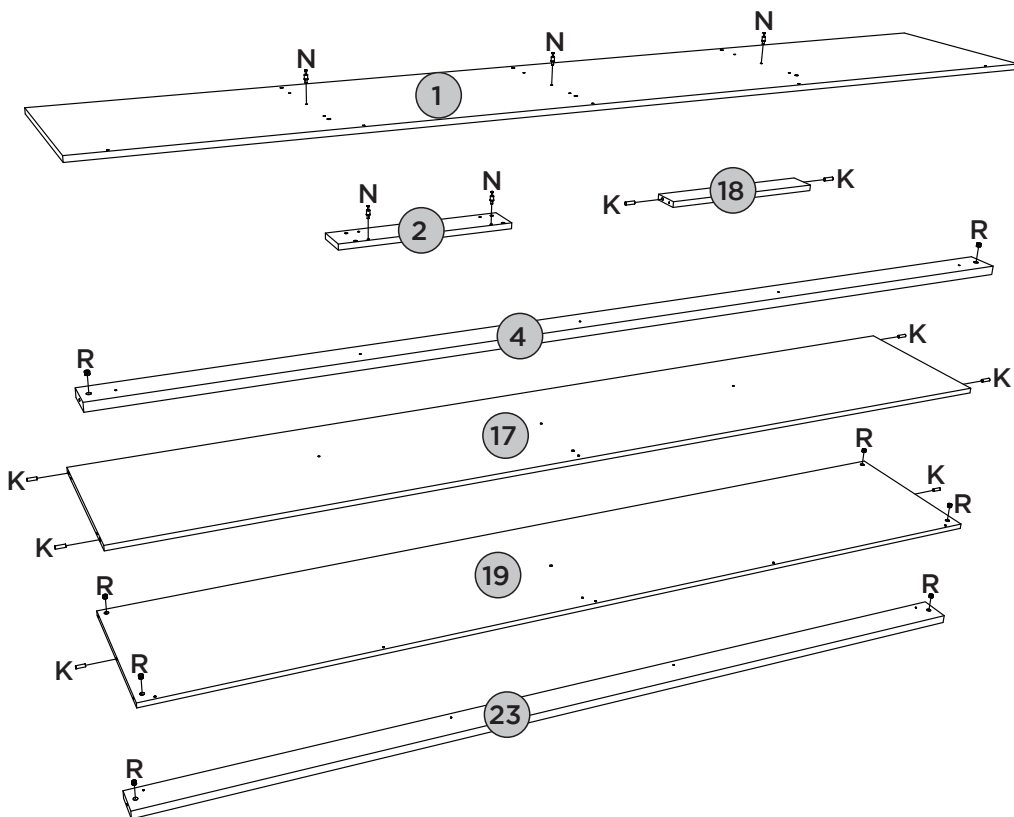
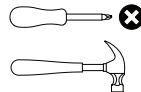





PASSO 2

ITM/D313-

PEÇAS REQUERIDAS

5	TAMPO DAS GAVETAS	x2
6	DIVISÃO ESQUERDA MENOR	x1
8	LATERAL ESQUERDA	x1
9	DIVISÃO GAVETA ESQUERDA	x1

ACESSÓRIOS REQUERIDOS

H		22
K		14
S		02
W		06

FERRAMENTAS NECESSÁRIAS

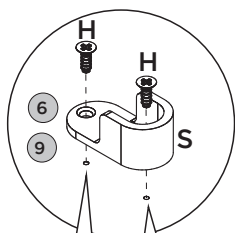
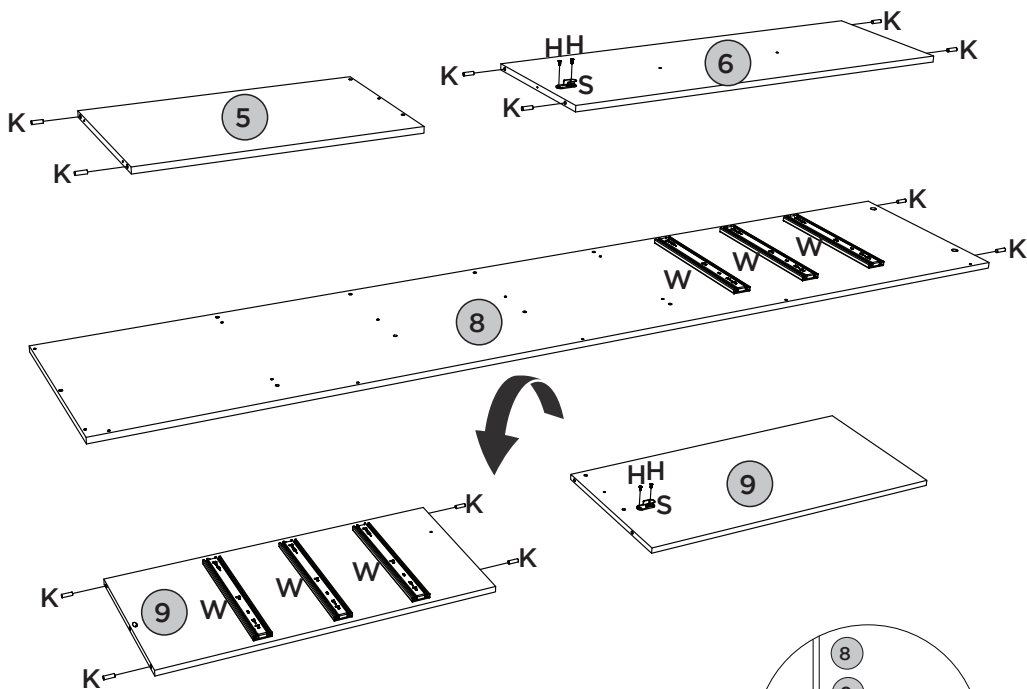
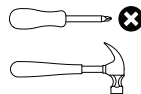

**Observe:
Furos
pré-marcados**

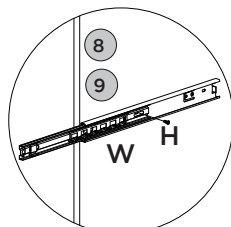
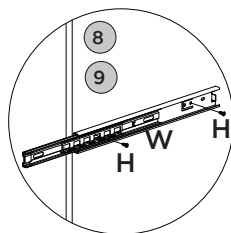
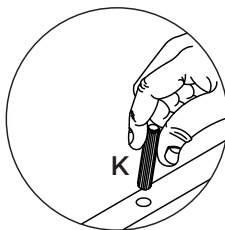



PASSO 3

ITM/D313-

PEÇAS REQUERIDAS

10=14=16	PRATELEIRA	x5
11	DIVISÃO CENTRAL	x1
12	PRATELEIRA DO CALCEIRO	x1

ACESSÓRIOS REQUERIDOS

H		06
K		28
S		03

FERRAMENTAS NECESSÁRIAS

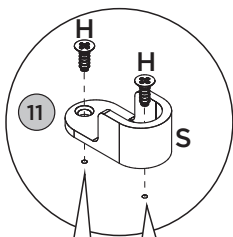
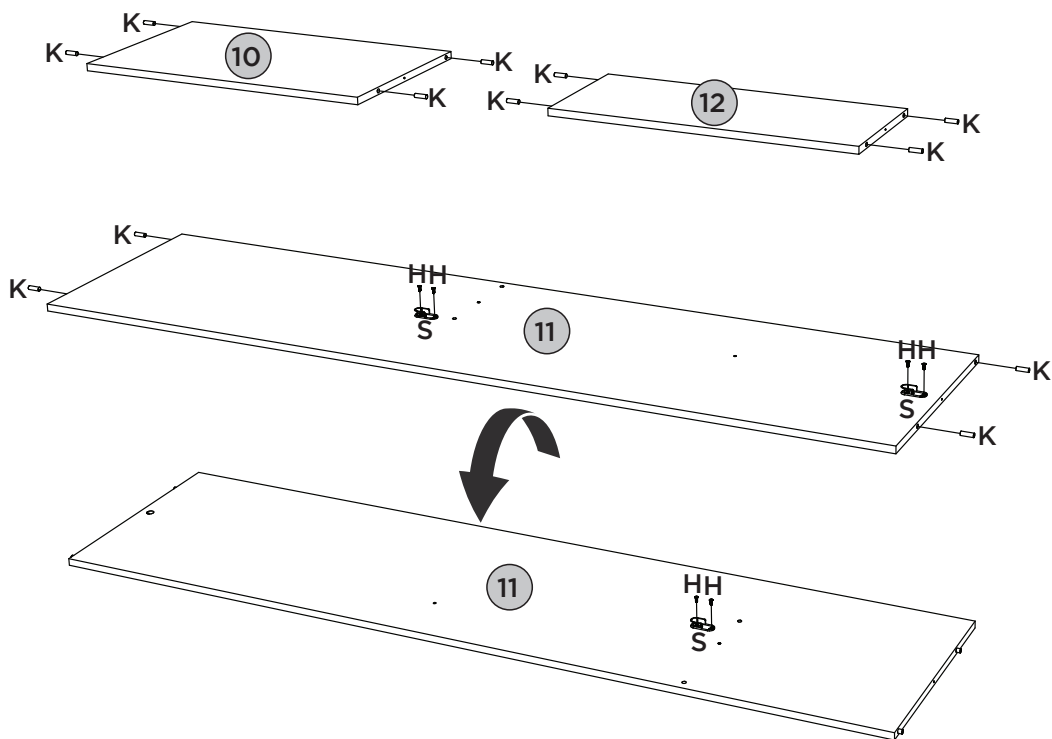
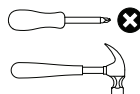

Observe:
Furos
pré-marcados

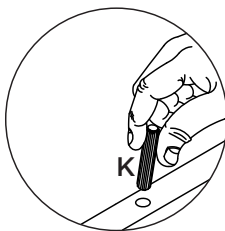





PASSO 4

ITM/D313-

PEÇAS REQUERIDAS

7	DIVISÃO DIREITA MENOR	x1
13	DIVISÃO GAVETA DIREITA	x1
15	LATERAL DIREITA	x1

ACESSÓRIOS REQUERIDOS

H		20
K		10
S		01
W		06

FERRAMENTAS NECESSÁRIAS

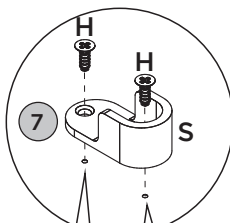
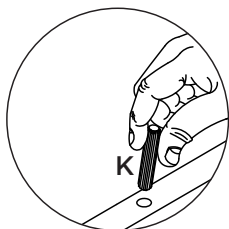
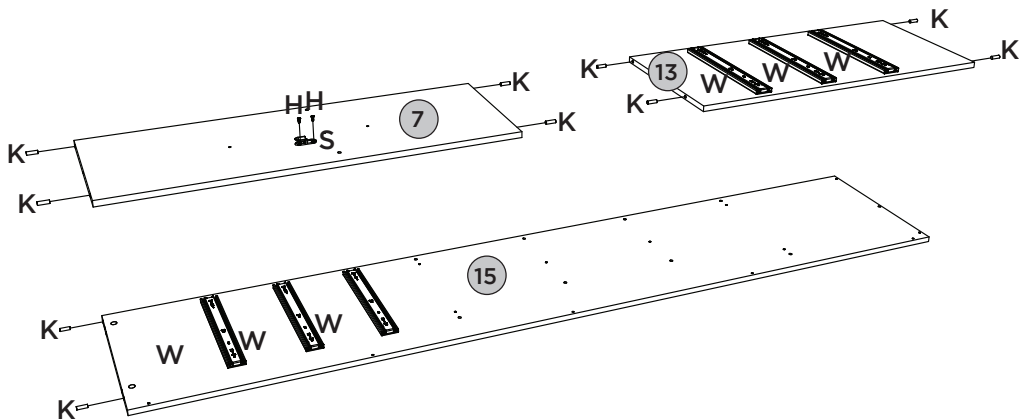
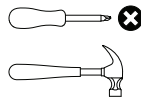

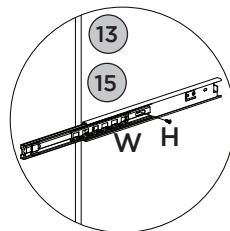
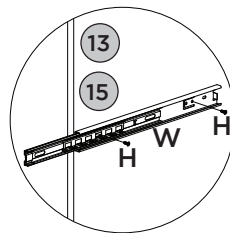

**Observe:
Furos
pré-marcados**



PASSO 5**PEÇAS REQUERIDAS**

1	BASE	x1
2	TRAVESSA LATERAL BASE	x2
3	TRAVESSA CENTRAL BASE	x3

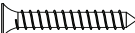
ACESSÓRIOS REQUERIDOS

F			10
K			10

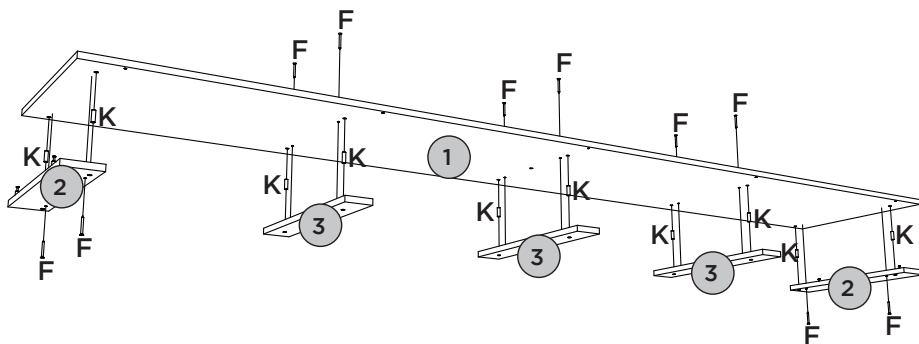
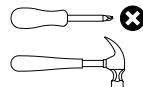
FERRAMENTAS NECESSÁRIAS**PASSO 6****PEÇAS REQUERIDAS**

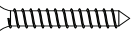

4	TRAVESSA FRONTAL BASE	x1
---	-----------------------	----

ACESSÓRIOS REQUERIDOS

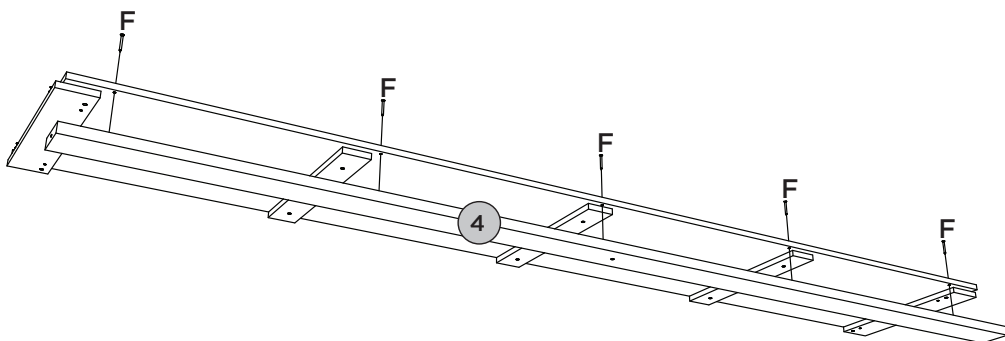
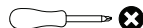
F			05
---	---	---	----

FERRAMENTAS NECESSÁRIAS

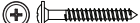
ACESSÓRIOS REQUERIDOS

D		25
T		10

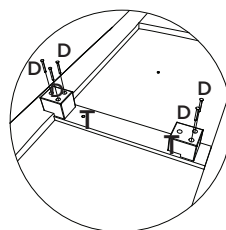
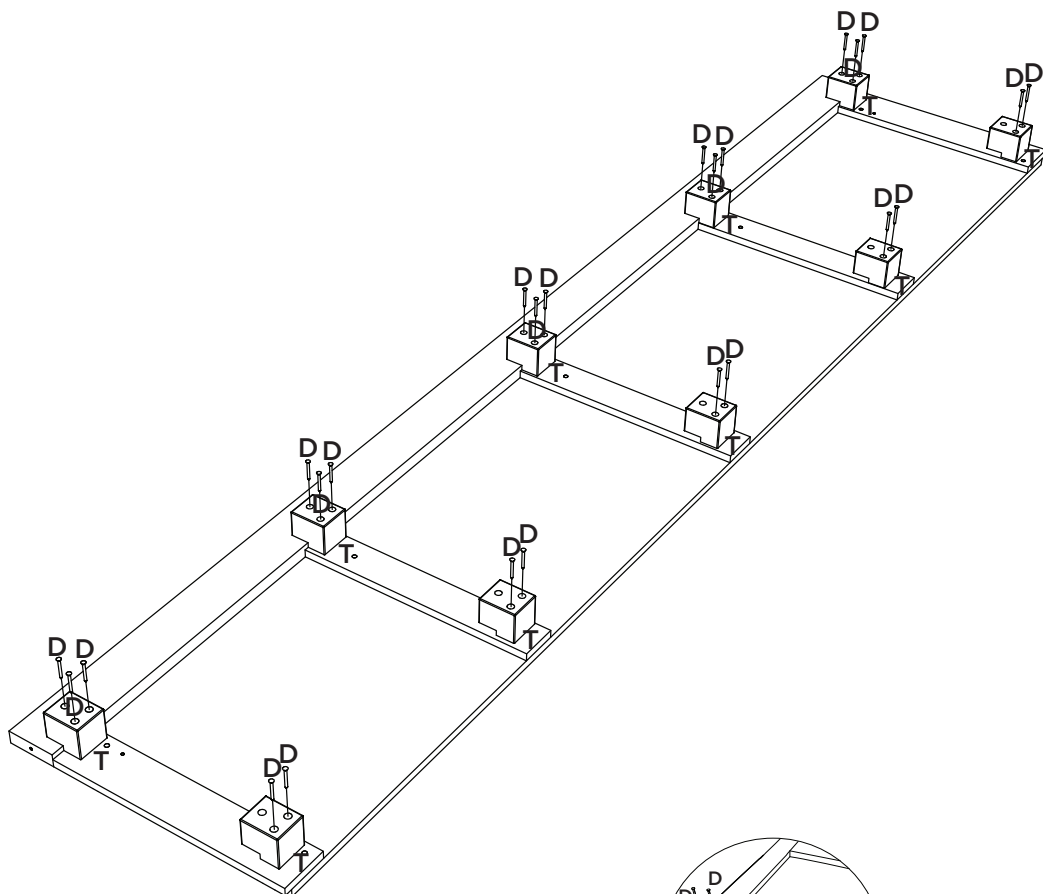
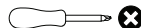
FERRAMENTAS NECESSÁRIAS

PASSO 8

ITM/D313-

PEÇAS REQUERIDAS

5	TAMPO DAS GAVETAS	x2
6	DIVISÃO ESQUERDA MENOR	x1
7	DIVISÃO DIREITA MENOR	x1

ACESSÓRIOS REQUERIDOS

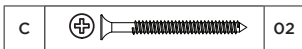



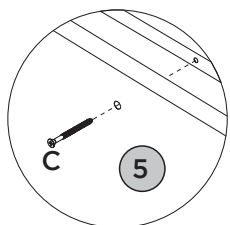
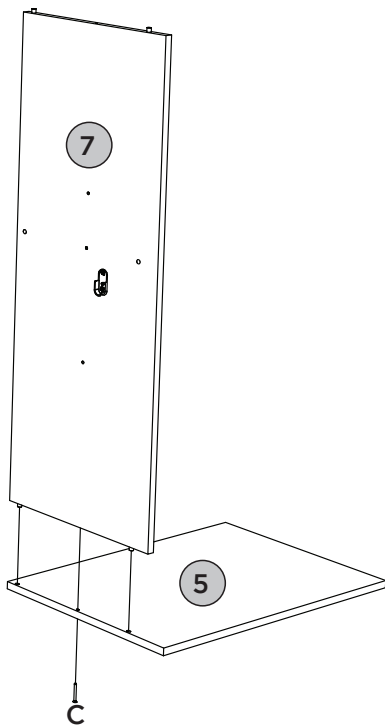
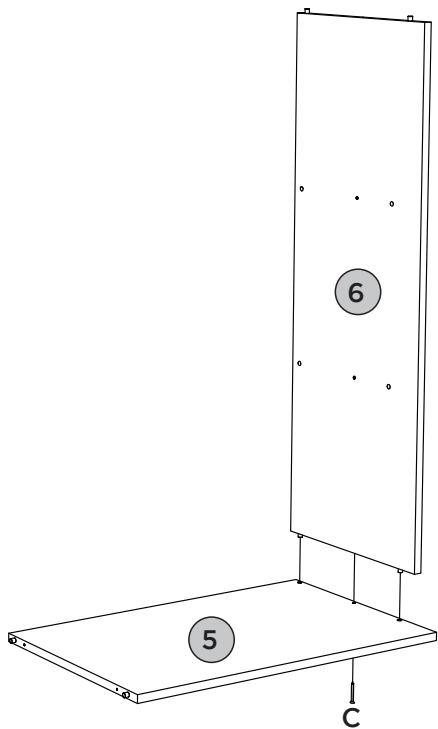
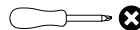

FERRAMENTAS NECESSÁRIAS



PASSO 9**PEÇAS REQUERIDAS**

8	LATERAL ESQUERDA	x1
9	DIVISÃO GAVETA ESQUERDA	x1
10	PRATELEIRA	x2

ACESSÓRIOS REQUERIDOS

C		06
H		02
O		01
Q		03

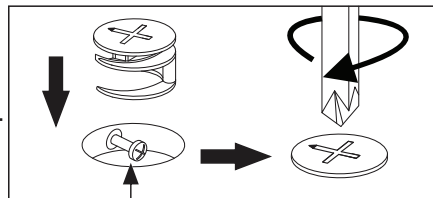
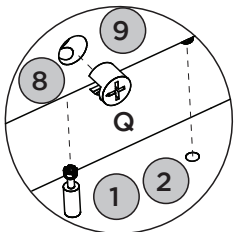
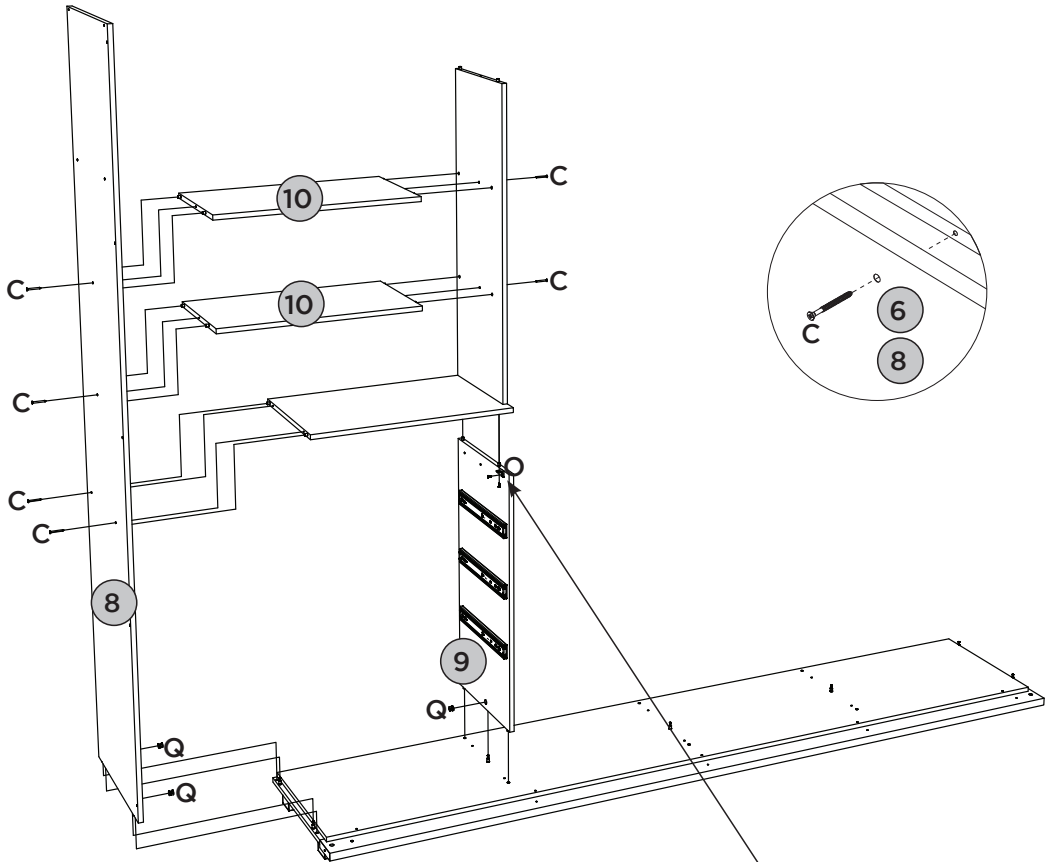
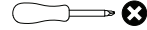
FERRAMENTAS NECESSÁRIAS

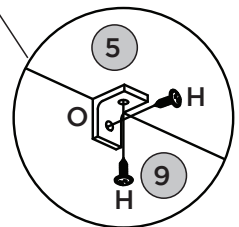

A cabeça do parafuso minifix precisa estar no centro



PEÇAS REQUERIDAS

11	DIVISÃO CENTRAL	x1
12	PRATELEIRA DO CALCEIRO	x1

ACESSÓRIOS REQUERIDOS

C		02
Q		01

FERRAMENTAS NECESSÁRIAS

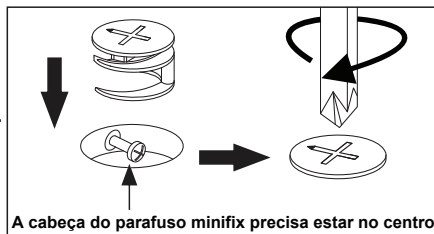
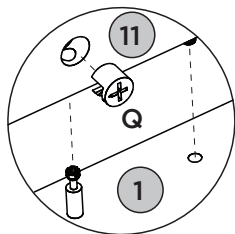
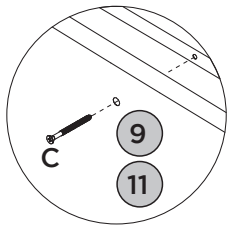
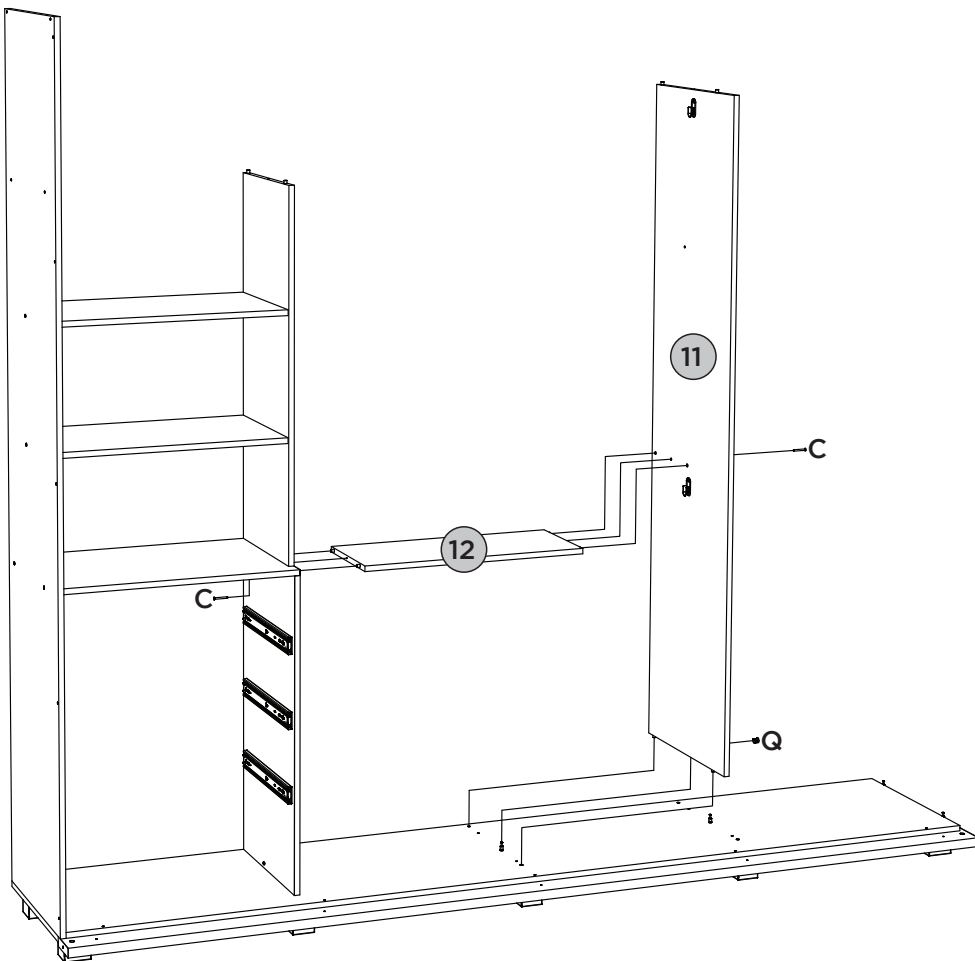
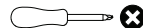









PASSO 11

PEÇAS REQUERIDAS

13	DIVISÃO GAVETA DIREITA	x1
14	PRATELEIRA	x1

ACESSÓRIOS REQUERIDOS

C			02
H			02
O			01
Q			01

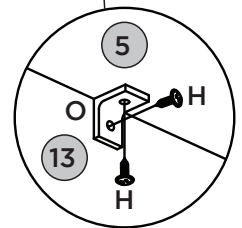
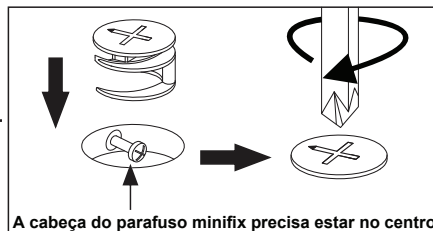
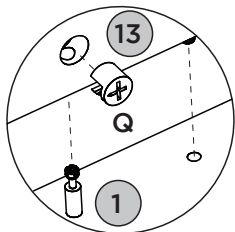
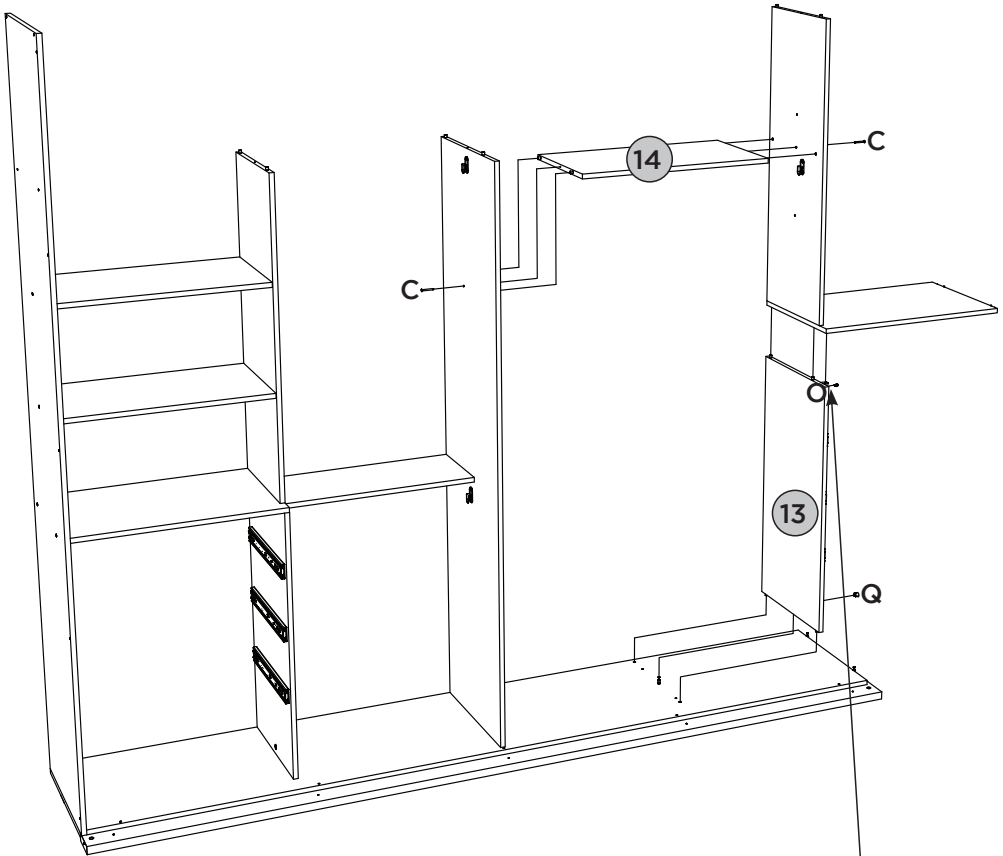
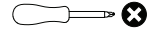

FERRAMENTAS NECESSÁRIAS



PEÇAS REQUERIDAS

15	LATERAL DIREITA	x1
16	PRATELEIRA	x2
17	CHÃO DO MALEIRO	x1
18	RIPA DO MALEIRO	x1
19	TAMPO SUPERIOR	x1

ACESSÓRIOS REQUERIDOS

B		04
C		15
Q		02

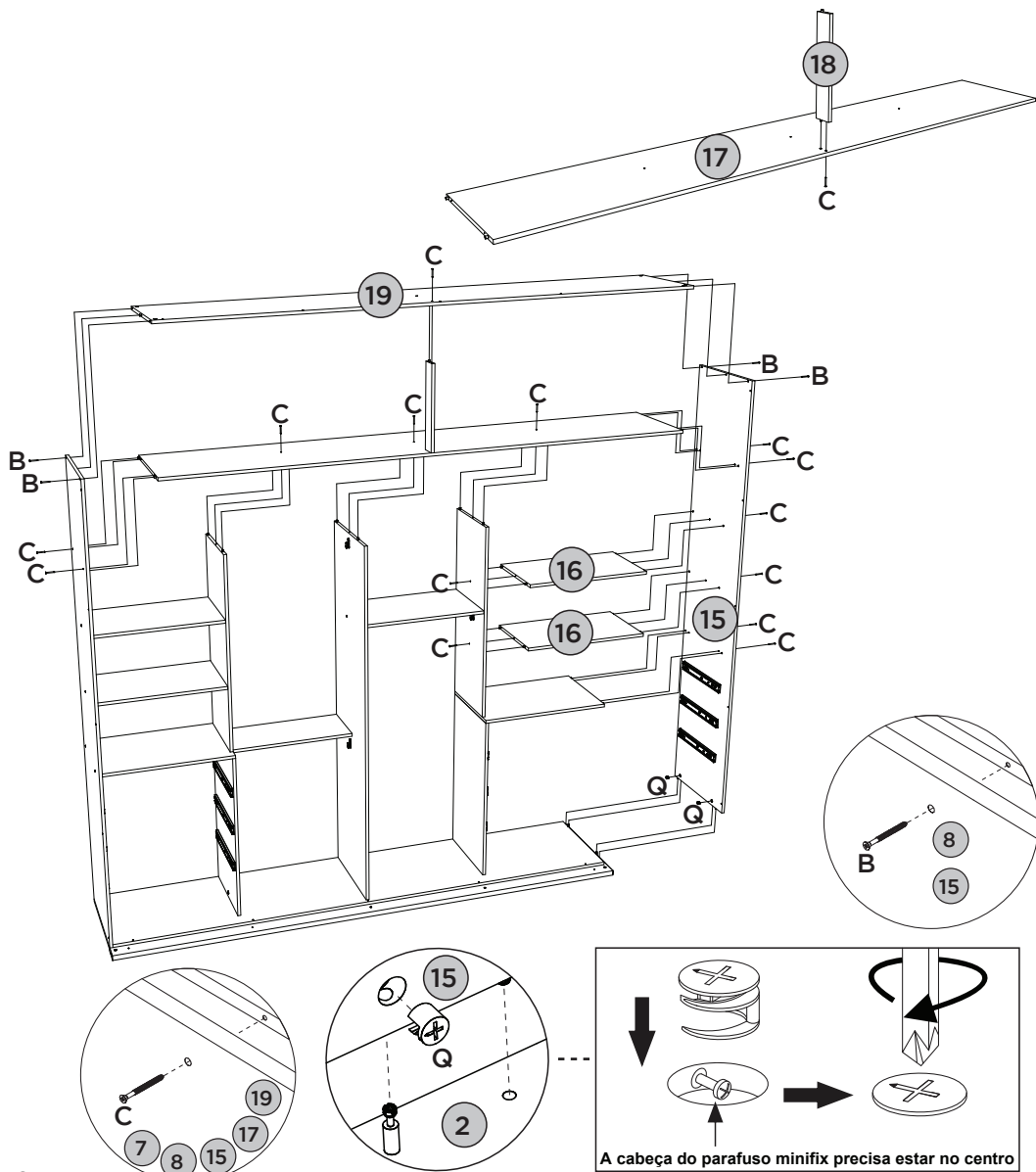

FERRAMENTAS NECESSÁRIAS



PEÇAS REQUERIDAS

20	FUNDO SUPERIOR	x1
21	FUNDO	x8

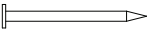
ACESSÓRIOS REQUERIDOS

L		217
M		75
Y		04

FERRAMENTAS NECESSÁRIAS

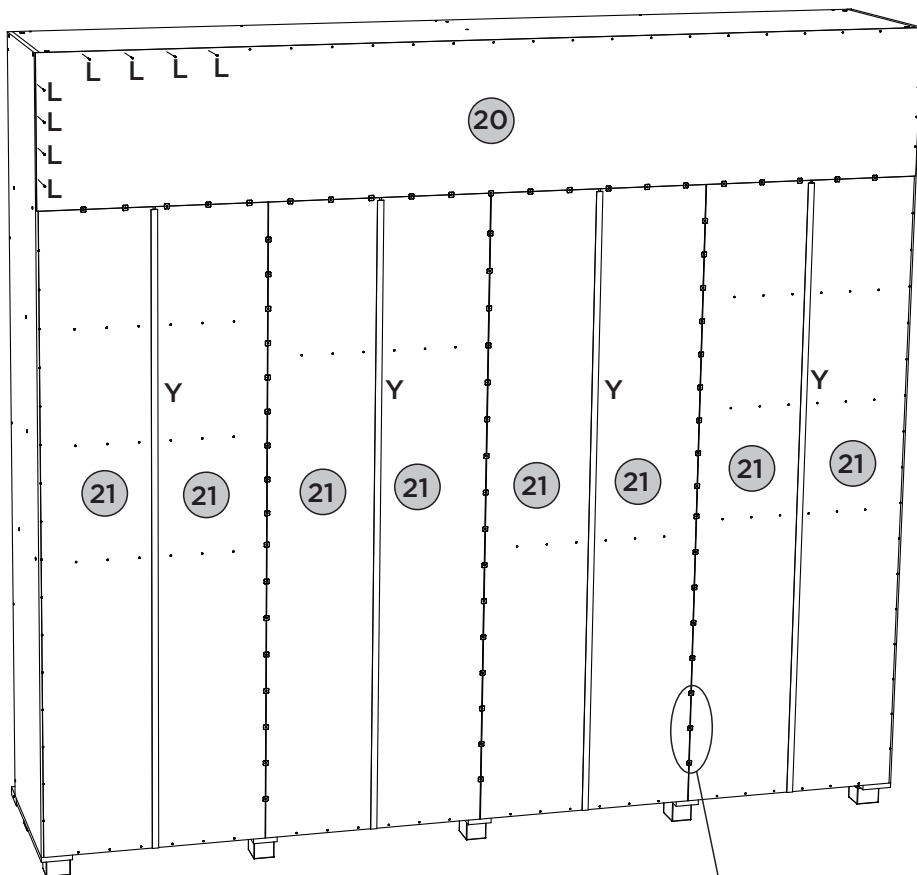
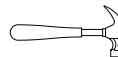

Fixar os pregos a uma distância de 100mm de um para outro.

Fijar las uñas a un distancia de 100mm uno a otro.

Fix the nails at a distance of 100mm from one to the other

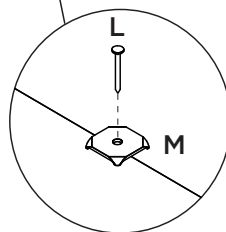

PEÇAS REQUERIDAS

22	MOLDURA LATERAL	x2
23	MOLDURA SUPERIOR	x1

ACESSÓRIOS REQUERIDOS

A		04
F		15
H		12
U		01
X		03
Z		01
AA		01

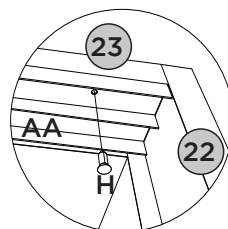
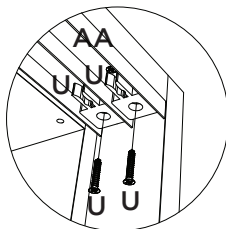
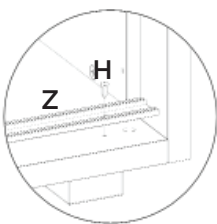
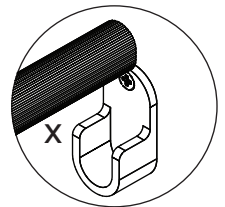
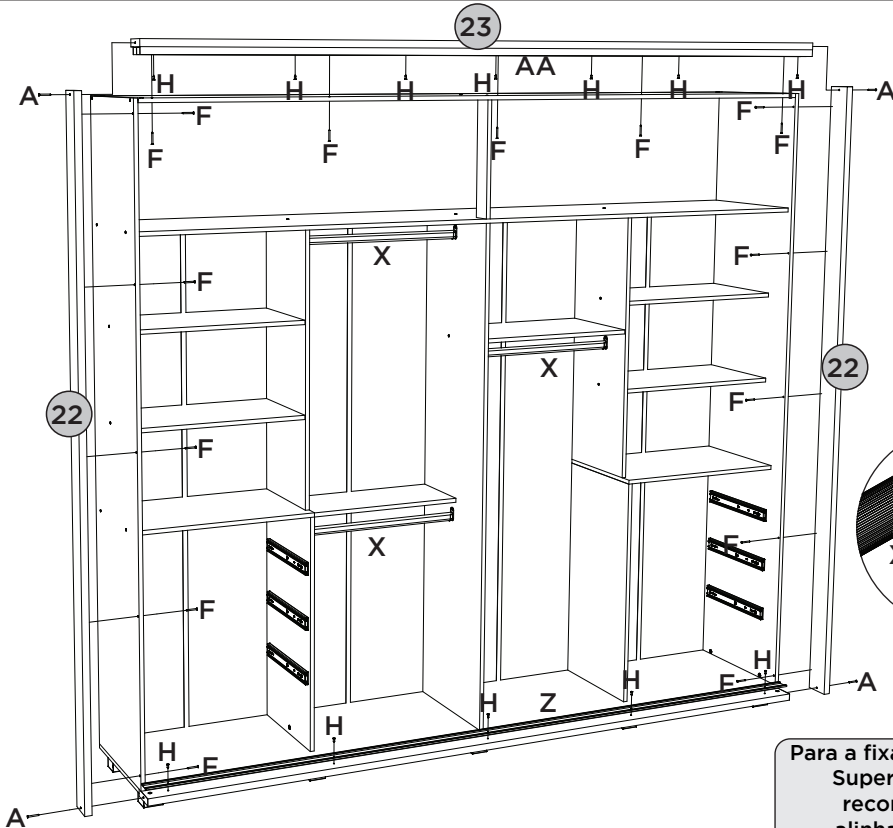
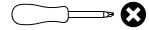
FERRAMENTAS NECESSÁRIAS

Para a fixação do Trilho Superior (AA) é recomendado alinhá-lo com a Moldura Superior (23).



Para fijar el Riel Superior (AA) se recomienda alinearlo con el Marco Superior (23).

For fixing the Upper Rail (AA) it is recommended align it with the Upper Bezel (23).

PASSO 15**PEÇAS REQUERIDAS**

24	PAINEL MENOR	x2
25	PAINEL COM APLIQUE	x2
28	PAINEL MAIOR	x2

ACESSÓRIOS REQUERIDOS

G		68
U		01
V		04

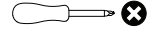
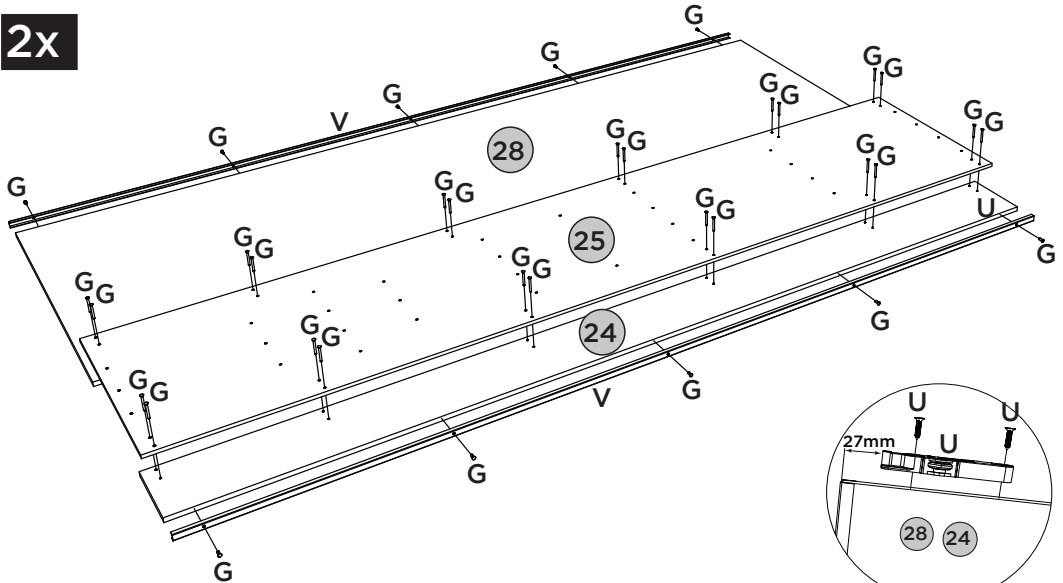
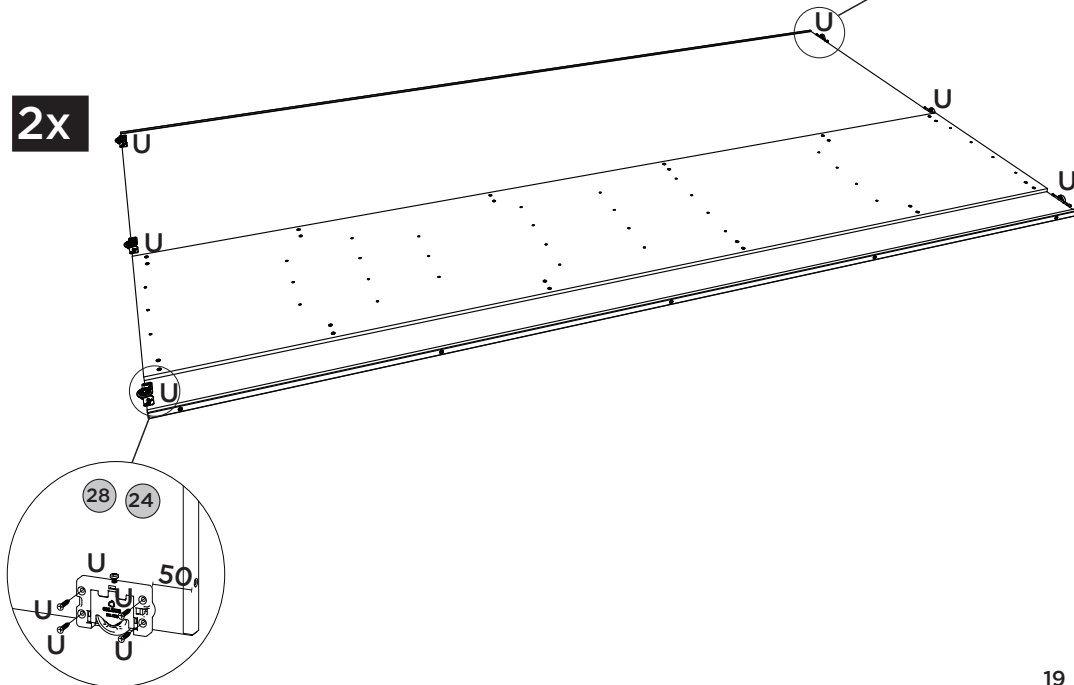
FERRAMENTAS NECESSÁRIAS**2x****2x**

PASSO 16**PEÇAS REQUERIDAS**

26	MOLDURA 1780MM	x8
27	MOLDURA 680MM	x6

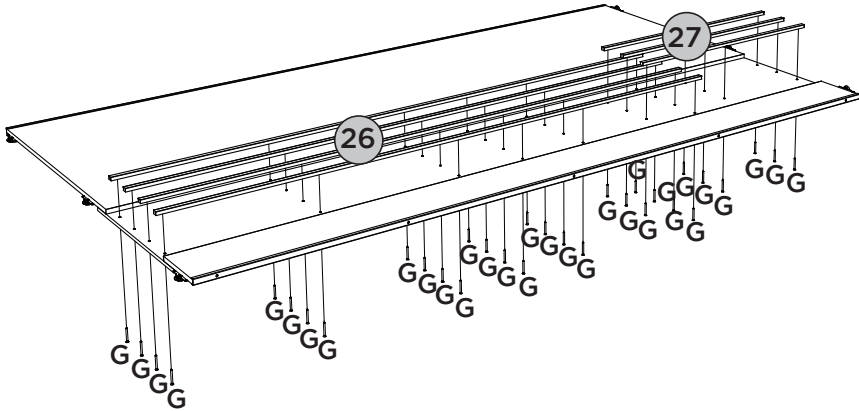

ACESSÓRIOS REQUERIDOS

G		66
---	---	----

FERRAMENTAS NECESSÁRIAS**2x****PASSO 17****PEÇAS REQUERIDAS**

24	PAINEL MENOR	x2
25	PAINEL COM APLIQUE	x2
28	PAINEL MAIOR	x2

ACESSÓRIOS REQUERIDOS

J		16
AE		20

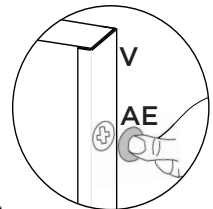
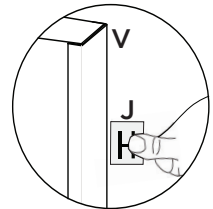
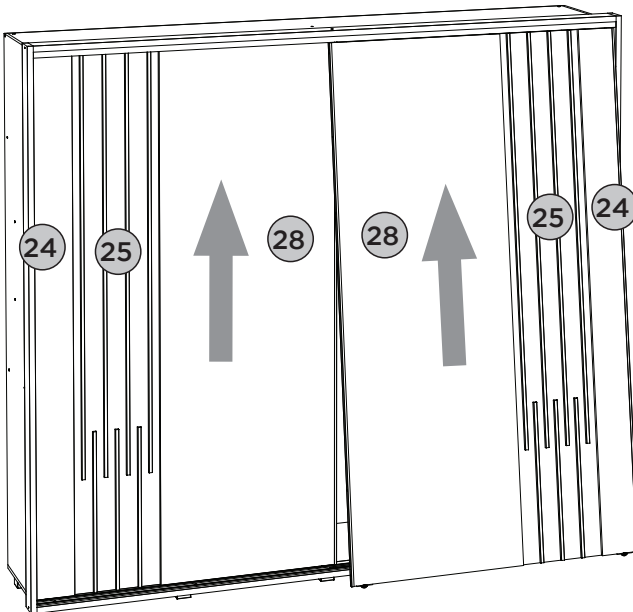

Para a colocação das portas nos trilhos encaixe primeira a porta no trilho superior (AA) e em seguida no trilho de alumínio inferior (Z).

Para la colocación de las puertas en la pista instalación de la puerta en la primera banda superior (AA) y luego el riel de aluminio inferior (Z).



For placing the doors on the rails fitting the door on the rail first (AA) and then on the lower aluminum rail (Z).

PASSO 18

PEÇAS REQUERIDAS

30	LADO DE GAVETA	x12
----	----------------	-----

ACESSÓRIOS REQUERIDOS

K		48
AB		

FERRAMENTAS NECESSÁRIAS

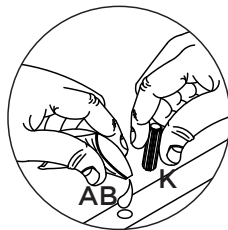
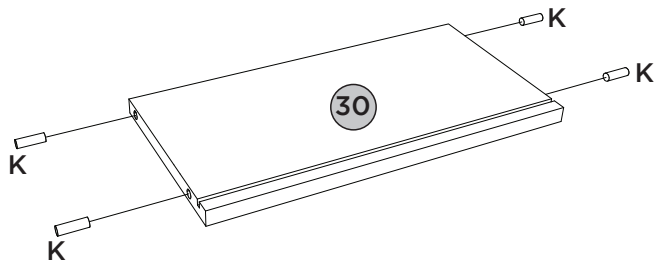



PASSO 19

PEÇAS REQUERIDAS

29	RIPA DE TRÁS	x6
30	LADO DE GAVETA	x12
31	FUNDO DE GAVETA RECORTADO	x6

ACESSÓRIOS REQUERIDOS

E		24
AB		

FERRAMENTAS NECESSÁRIAS

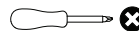

6x

1º

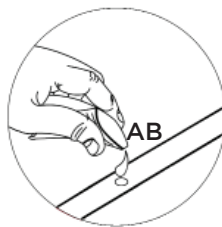
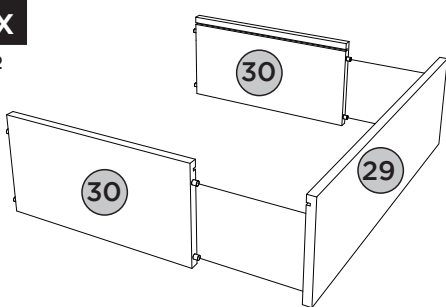

6x

2º

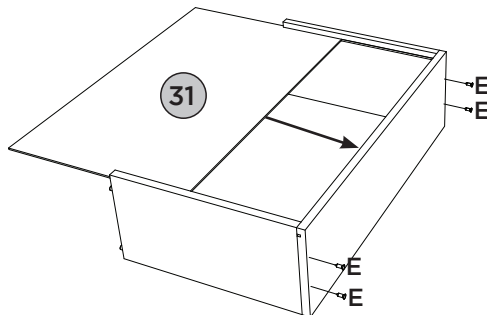
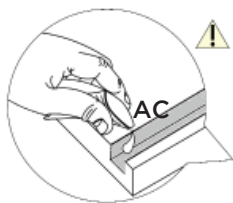







PASSO 20

ITM/D313-

PEÇAS REQUERIDAS

32	FRENTE DE GAVETA	x6
----	------------------	----

ACESSÓRIOS REQUERIDOS

G		12
H		84
I		24
P		12
W		06
AB		

FERRAMENTAS NECESSÁRIAS

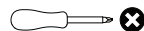

6x
3º

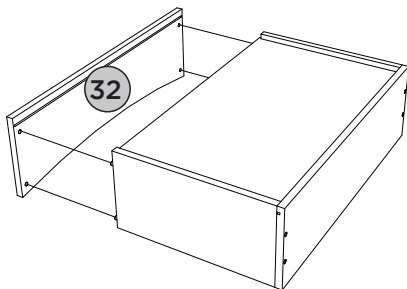

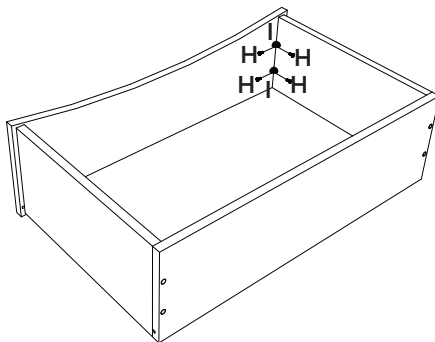
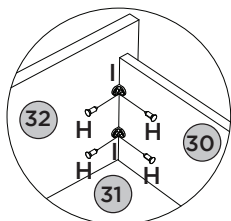

6x
4º

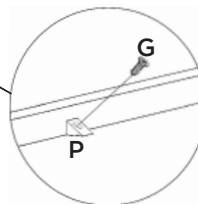
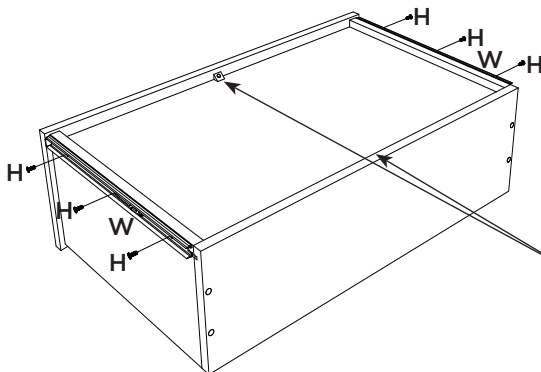

6x
5º



ACESSÓRIOS REQUERIDOS

AC		02
AD		07
AF		50
AG	HENN	01

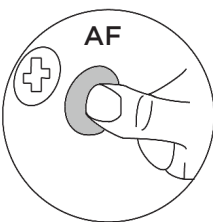
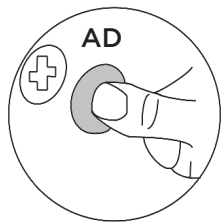
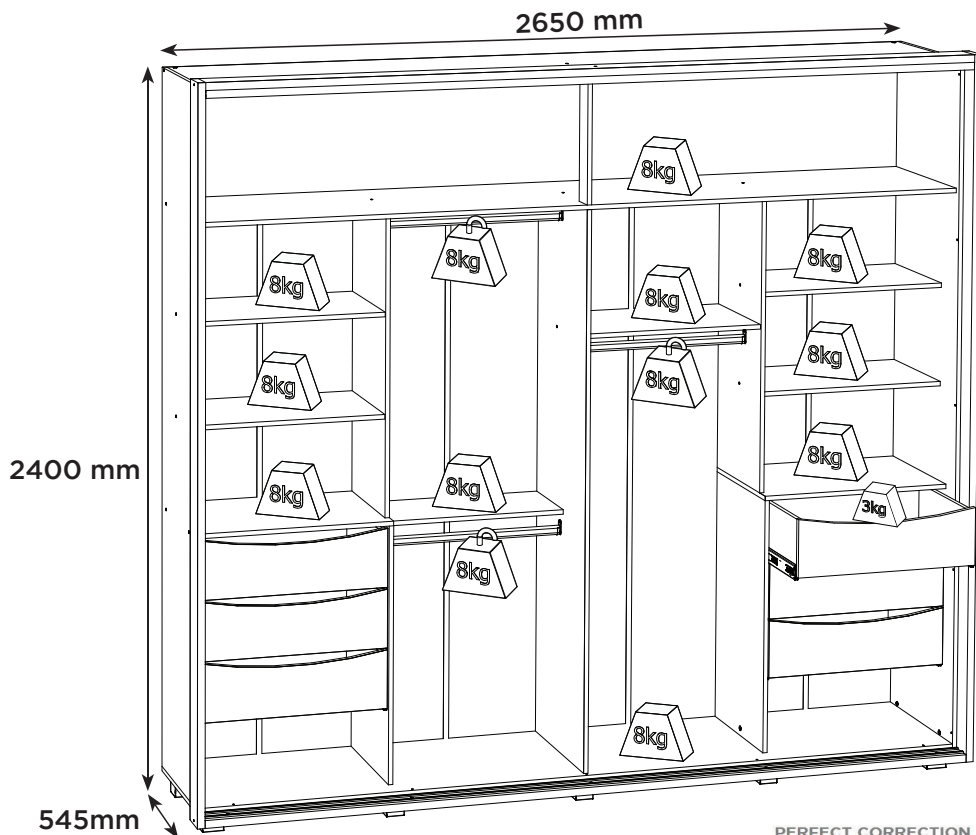

PERFECT CORRECTION
CORRECCIÓN PERFECTA

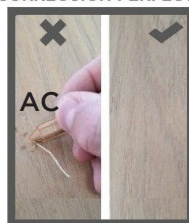

Pesos máximos recomendados com carga distribuída
 Peso máximo recomendado con la carga distribuida
 Recommended maximum weight with distributed load.

Produto Concluído
Producto terminado
Finished Product

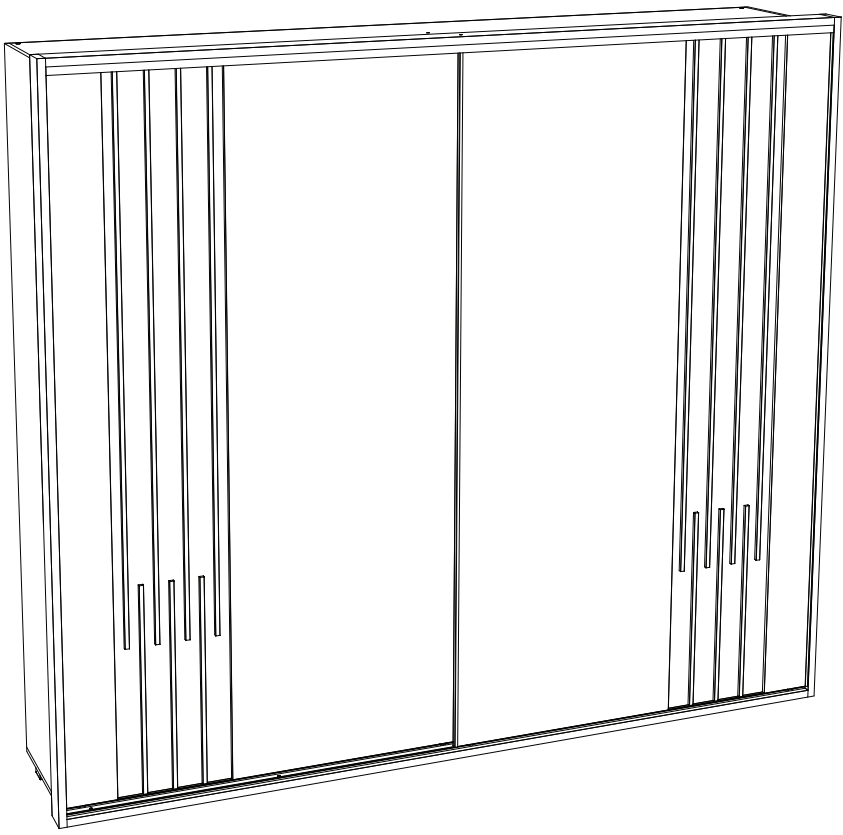

INSTRUÇÕES DE MONTAGEM



KIT ESPELHO 1124x750x3 COM 2 UNIDADES

c O970-64 - Prata

Item	Caixa	Qtd	Descrição	Medidas (mm)
01	1/1	02	Espelho	1124x750x3

Exemplo: Porta de Correr
(D313- Roupeiro Vicenza 2Pts Deslizantes) →

Ferragens

A		04x	B		04x
Suporte Bucha Cromada fixador espelho 3,5mm			Parafuso 3,5x14mm FLA Cromado		

AVISO

Para limpeza de seu móvel, use uma flanela seca ou umedecida, e não utilize produtos químicos que possam danificar seu produto.

SISTEMA DE MONTAGEM

O sistema de montagem dos produtos, funciona de acordo com a ordem crescente dos números indicados no desenho. Ex: 01, 02, 03, 04... até a conclusão da montagem.

Medidas em mm

Medida do Painel até o espelho

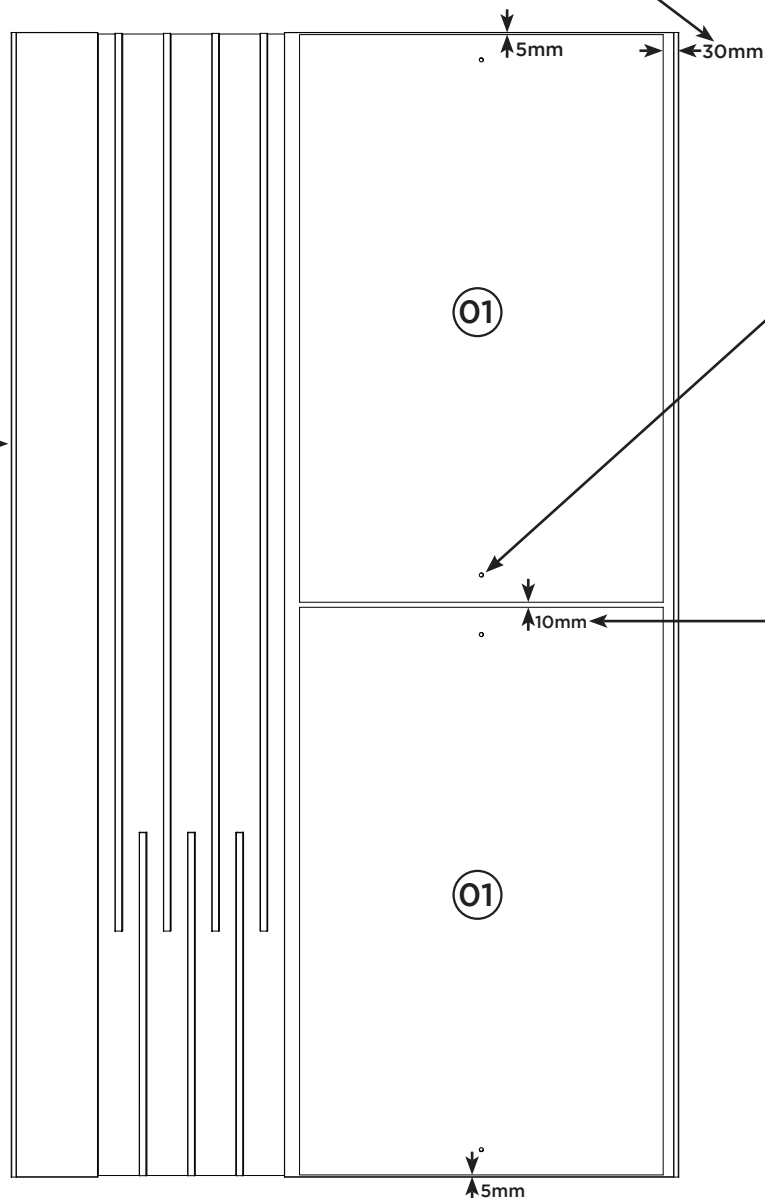

Fixar o Espelho com a Bucha (A) e o Parafuso (B)

Utilizar a parafusadeira com o torque 3.

Medida entre os espelhos

Requisitos para montagem

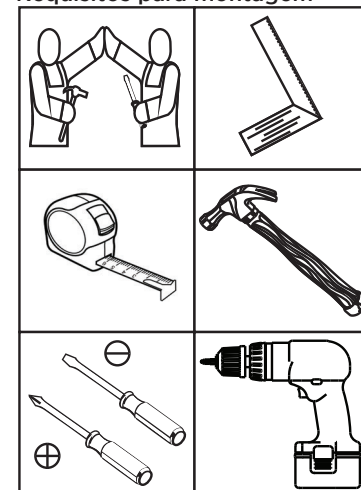

Imagens meramente ilustrativas