

PASSO 8

ITM/S352-
Rev 001

Pesos máximos recomendados com carga distribuída.
Peso máximo recomendado con la carga distribuida.
Recommended maximum weights with evenly distributed.

ACESSÓRIOS REQUERIDOS

T		46
U		03
V		01

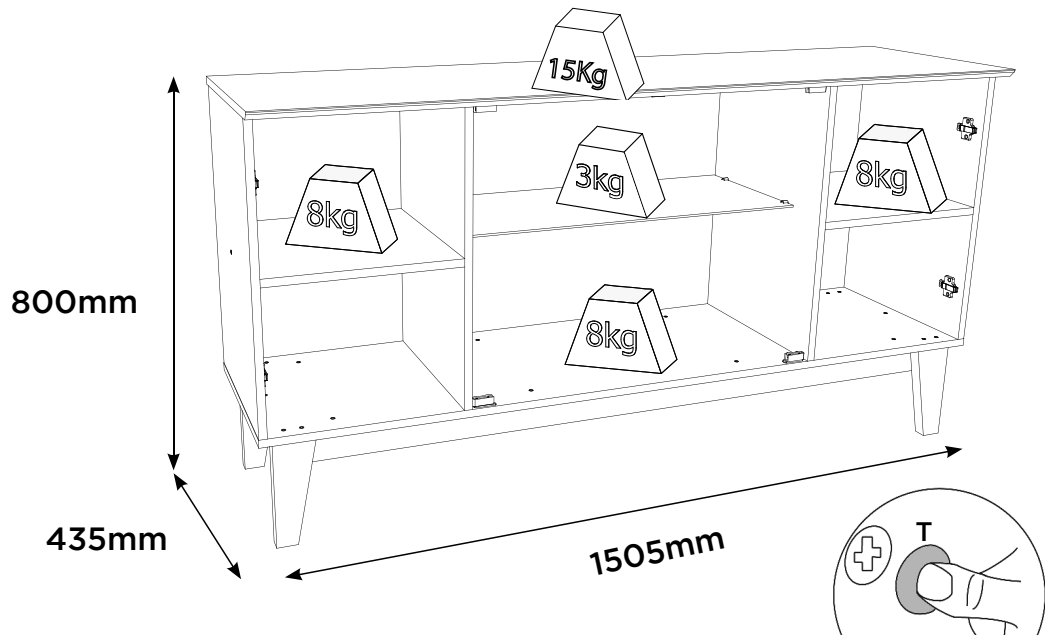

Produto Concluído
Producto terminado
Finished Product

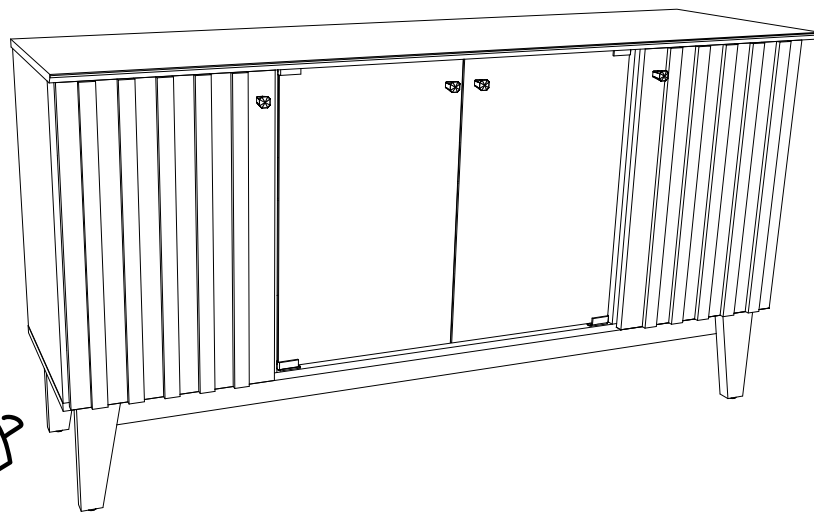

HENN

Ind. e Com. de Móveis Henn
Mondai - SC - Brasil

+55 49 3674.3500

@moveishenn
www.henn.com.br

ITM/S352- INSTRUÇÕES DE MONTAGEM

INSTRUCCIONES DE MONTAJE
ASSEMBLY INSTRUCTIONS

Buffet Eiffel 4 Portas | Buffet Eiffel 4 Puertas | Eiffel Buffet 4 Doors

S352-129 Off White/Nature

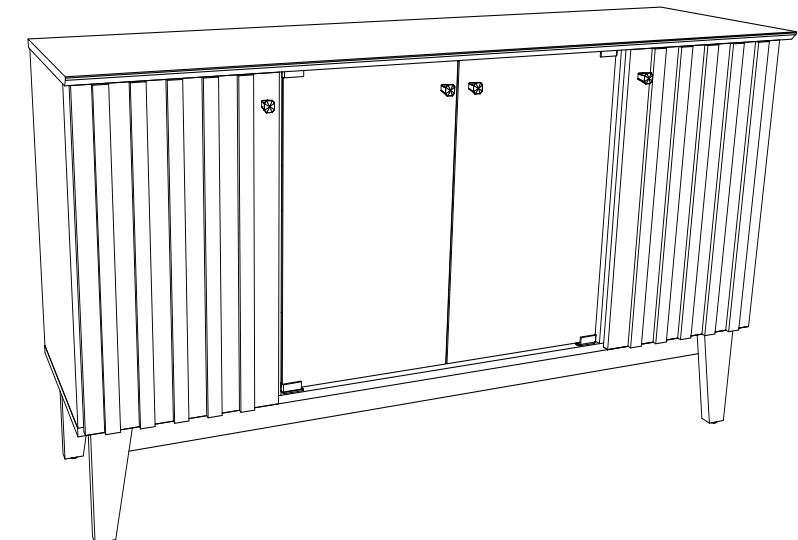

Requisitos para montagem Requisitos para la montaje Assembly Requirements

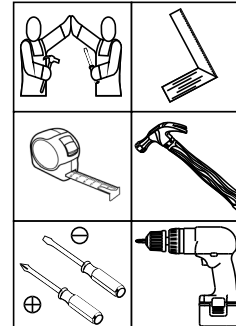

Imagens meramente ilustrativas, não acompanha o produto.
Imágenes ilustrativas, no incluidas con el producto.
Illustrative images, not included with the product.

AVISO
Para limpeza de seu móvel, use uma flanela seca ou umedecida, e não utilize produtos químicos que possam danificar seu produto.

SISTEMA DE MONTAGEM
O sistema de montagem dos produtos, funciona de acordo com a ordem crescente dos números indicados no desenho. Ex: 01, 02, 03, 04... até a conclusão da montagem.

ASSISTÊNCIA TÉCNICA
Para solicitação de Assistência Técnica você consumidor deverá entrar em contato com o Lojista a qual você realizou a compra deste produto e solicitar a assistência técnica das peças avariadas. A garantia abrange todas as peças, partes e componentes que eventualmente venham apresentar defeito de fabricação no prazo de 03 (três) meses, contando a partir da entrega do produto ao consumidor, mediante nota fiscal de compra. Se houver qualquer alteração na estrutura do produto ou ocorrer defeito por negligência do montador/consumidor em relação a instrução de montagem e manuseio, não será fornecido assistência técnica gratuita.

ADVERTENCIA
Para limpieza de su móvil, use una flanela seca o húmeda, y no utilice productos químicos que puedan dañar su producto.

SISTEMA DE MONTAJE
El sistema de montaje de los productos funciona de acuerdo con el orden creciente de los números indicados en el dibujo. Ej.: 01, 02, 03, 04... hasta la conclusión del montaje.

ASISTENCIA TÉCNICA
Para solicitar Asistencia Técnica, el consumidor debe comunicarse con el Comercio que usted realizó la compra de este producto y solicita asistencia técnica para las partes dañadas. La garantía cubre todas las partes, piezas y componentes que eventualmente puedan presentar defecto de fabricación en el plazo de 03 (tres) meses, contados a partir de la entrega del producto al consumidor, mediante factura de compra. Si se produce algún cambio en la estructura del producto o se produce un defecto por negligencia del montador/consumidor en relación con las instrucciones de montaje y manipulación, no se prestará asistencia técnica gratuita.

NOTICE
To clean your furniture, use a dry or wet cloth, and do not use chemicals that may damage your product.

ASSEMBLY SYSTEM
The products' assembly system works according to the increasing order of the indicated numbers. For example: 01, 02, 03, 04 ... to the end of the assembly.

TECHNICAL ASSISTANCE
To request Technical Assistance, the consumer must contact the retailer from whom you purchased this product and request technical assistance for the damaged parts. The warranty covers all parts, parts and components that may eventually present a manufacturing defect within a period of 03 (three) months, counting from the delivery of the product to the consumer, by means of a purchase invoice. If there is any change in the structure of the product or defect occurs due to negligence of the assembler/consumer in relation to the assembly and handling instruction, free technical assistance will not be provided.



ACESSÓRIOS | ACCESORIOS | ACCESSORIES

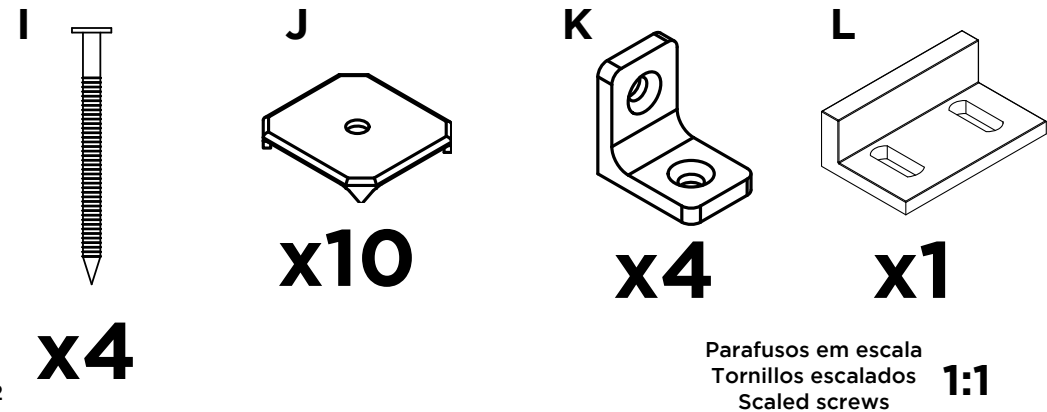
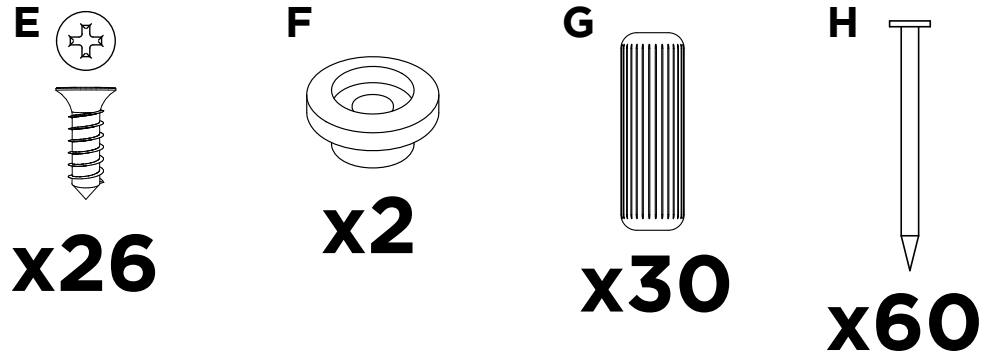
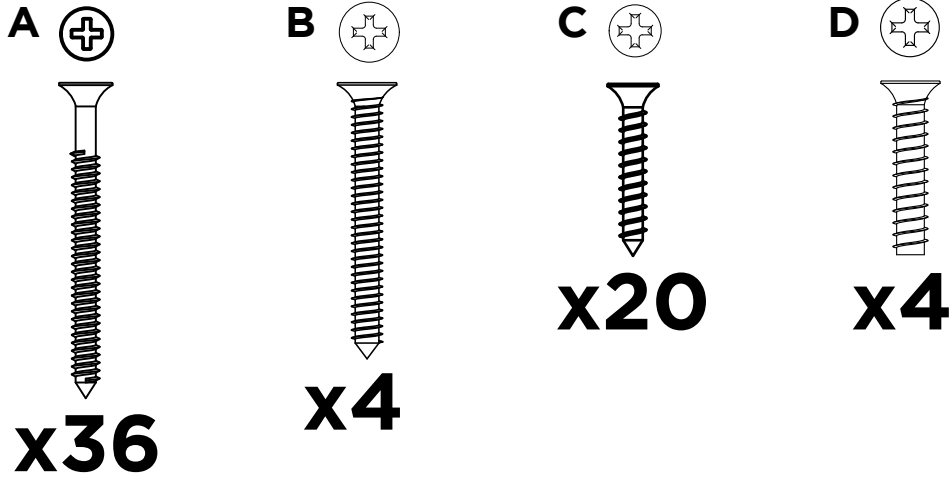







PASSO 7

PEÇAS REQUERIDAS

14	PORTA	x2
15	APLIQUE	x10
16	PORTA DE VIDRO	x2

ACESSÓRIOS REQUERIDOS

C		20
D		04
E		08
F		02
O		04
R		04

FERRAMENTAS NECESSÁRIAS

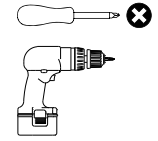

Para porta (14): Defina para o modo de perfuração.

Faça a furação passante para fixar os puxadores (O).

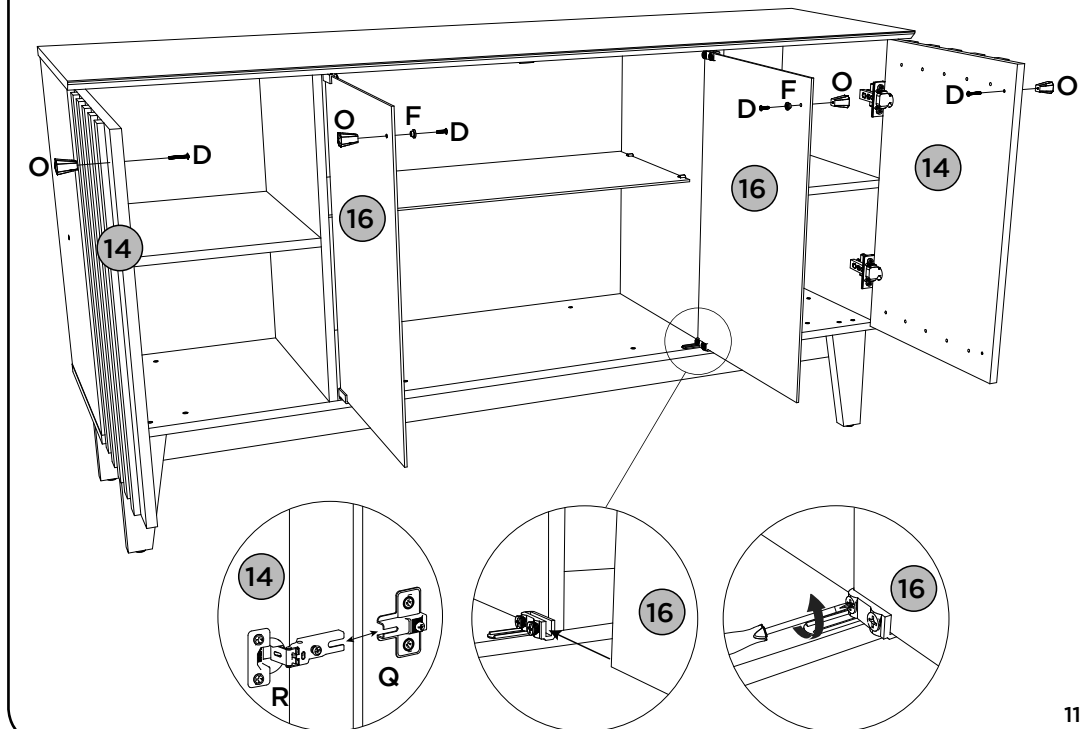
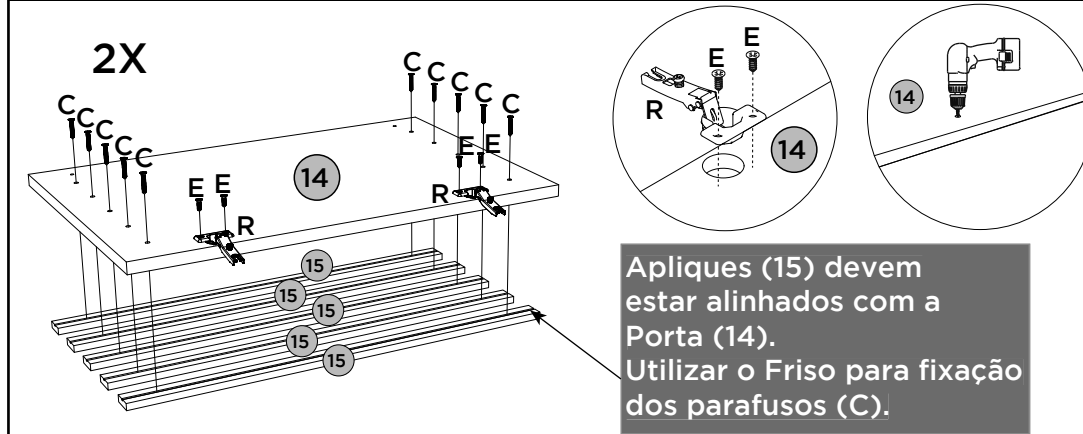

PASSO 6



ITM/S352-

PEÇAS REQUERIDAS

ACESSÓRIOS REQUERIDOS

FERRAMENTAS NECESSÁRIAS

12	FUNDO	x2
13	FUNDO MAIOR	x1

H		60
J		10

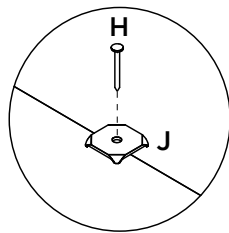
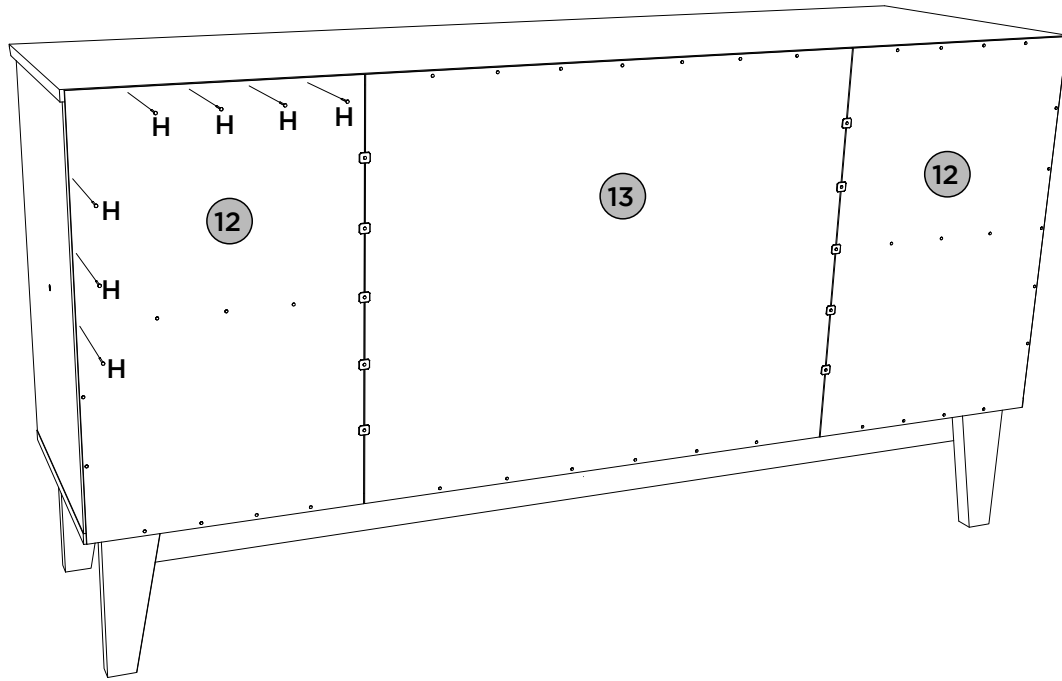
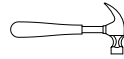

ACESSÓRIOS | ACCESORIOS | ACCESSORIES

ITM/S352-

M

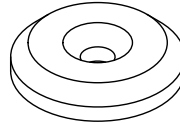

x4

N

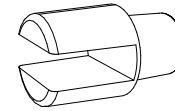

x4

O

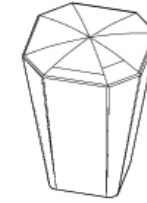

x4

P

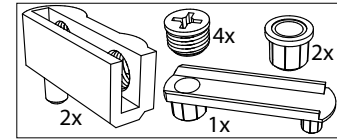

x2 Kits

Q

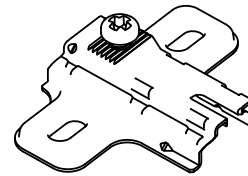

x4

R

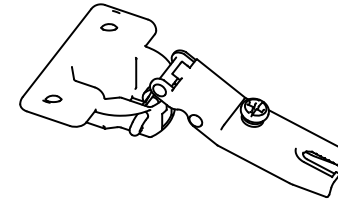

x4

S

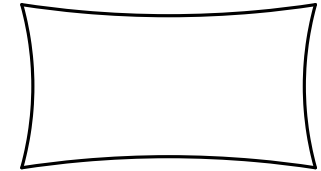

x1

T

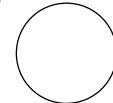

x46

U

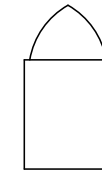

x3

V



x1

LISTA DE PEÇAS | LISTA DE PIEZAS | LIST OF PIECES

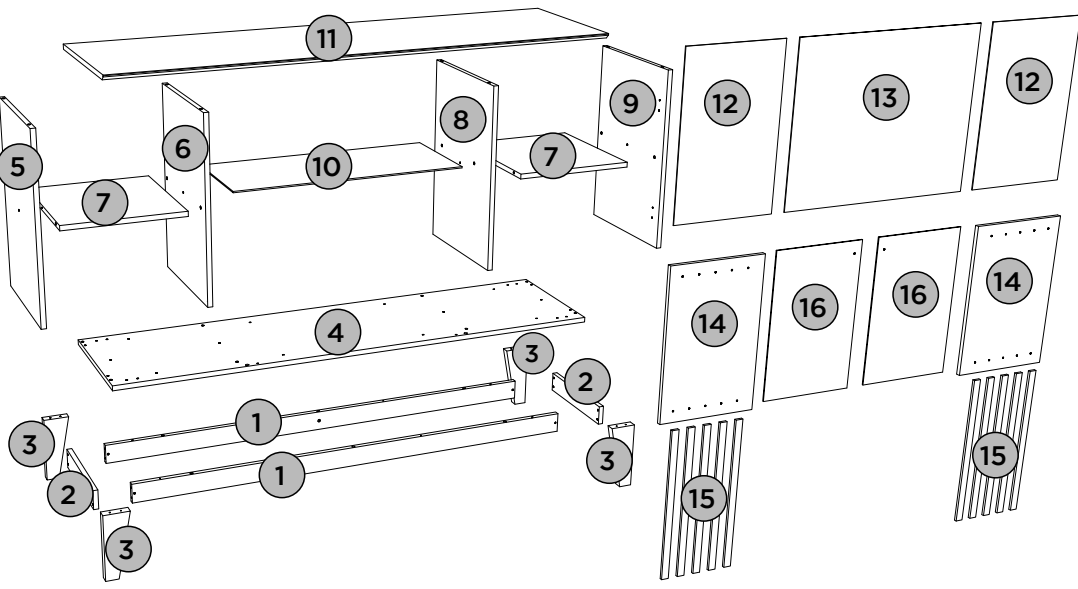

Item	Caixa Caja Box	Qtd Ctd Qty	Descrição Descripción Description	Dimensões (mm) Dimensiones (mm)		
				Comprimento Largo Length	Largura Ancho Width	Espessura Grosor Thickness
1	1/1	02	TRAVESSA INFERIOR TRAVESAÑO INFERIOR LOWER TRAY	1390	60	15
2	1/1	02	TRAVESSA LATERAL TRAVESAÑO LATERAL SIDE CROSSBEAM	305	60	15
3	1/1	04	PÉ PIE FOOT	205	80	25
4	1/1	01	BASE BASE BASE	1501	385	15
5	1/1	01	LATERAL ESQUERDA LADO IZQUIERDO LEFT SIDE	560	385	15
6	1/1	01	DIVISÃO ESQUERDA DIVISIÓN IZQUIERDA LEFT DIVISION	560	385	15
7	1/1	02	PRATELEIRA ESTANTE SHELF	360	385	15
8	1/1	01	DIVISÃO DIREITA DIVISIÓN DERECHA RIGHT DIVISION	560	385	15
9	1/1	01	LATERAL DIREITA LADO DERECHO RIGHT SIDE	560	385	15
10	1/1	01	PRATELEIRA DE VIDRO ESTANTE DE VIDRIO GLASS SHELF	714	300	4
11	1/1	01	TAMPO CUBRIR COVER	1505	430	15
12	1/1	02	FUNDO FONDO BACKGROUND	588	379	3
13	1/1	01	FUNDO MAIOR FONDO MÁS GRANDE BIGGER FUND	588	732	3
14	1/1	02	PORTA PUERTA DOOR	565	370	15
15	1/1	10	APLIQUE APLICAR APPLY	565	28	9
16	1/1	02	PORTA DE VIDRO PUERTA DE VIDRIO GLASS DOOR	550	352	4

PASSO 5

PEÇAS REQUERIDAS

10	PRATELEIRA VIDRO	x1
11	TAMPO	x1

ACESSÓRIOS REQUERIDOS

E		10
K		04
L		01
P		02
S		

FERRAMENTAS NECESSÁRIAS

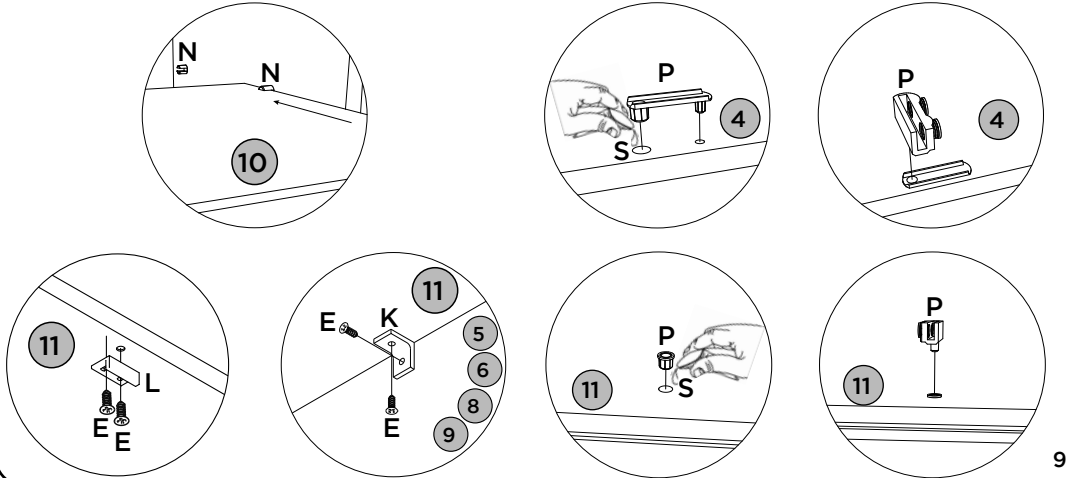
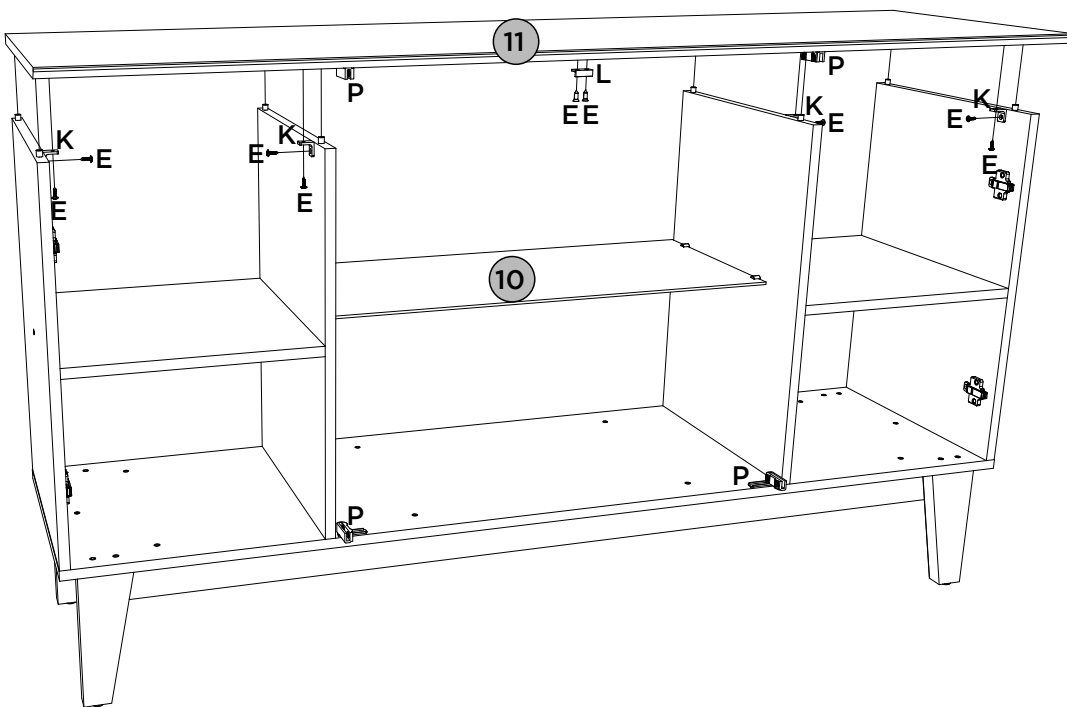
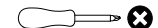

PASSO 4



ITM/S352-

PEÇAS REQUERIDAS

ACESSÓRIOS REQUERIDOS

FERRAMENTAS NECESSÁRIAS

5	LATERAL ESQUERDA	x1
6	DIVISÃO ESQUERDA	x1
7	PRATELEIRA	x2
8	DIVISÃO DIREITA	x1
9	LATERAL DIREITA	x1

A		06
S		

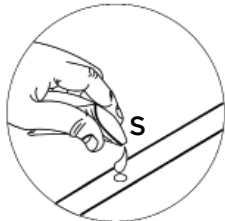
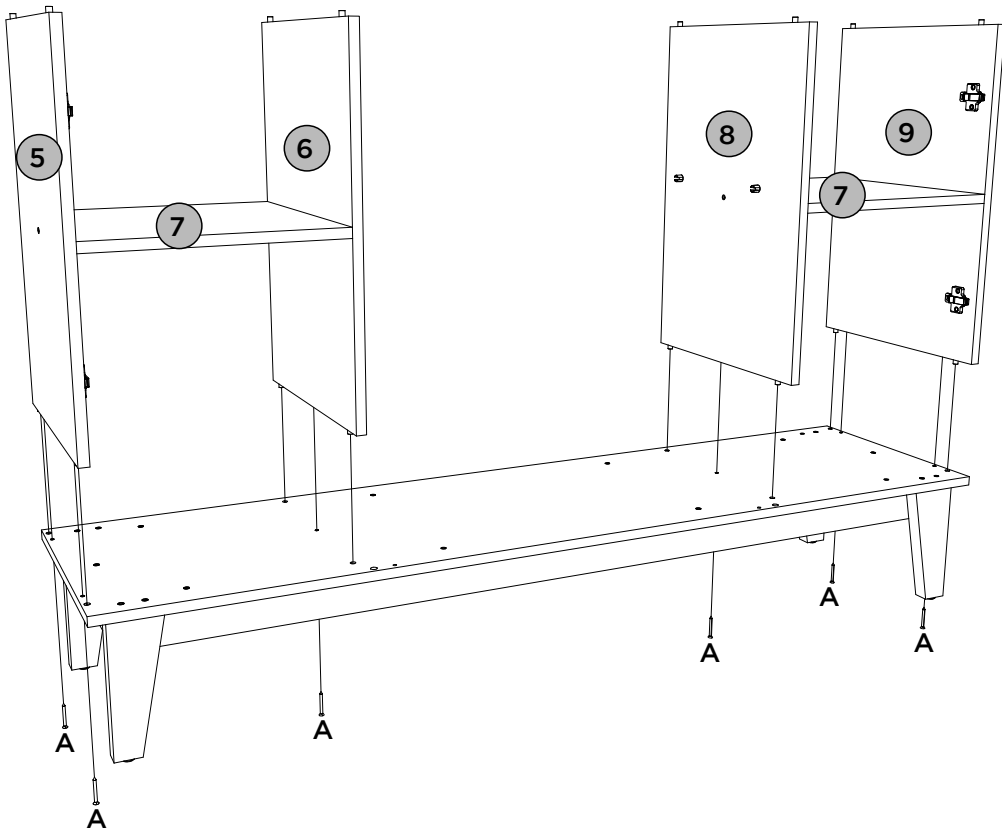
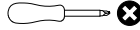

PASSO 1







ITM/S352-

PEÇAS REQUERIDAS

ACESSÓRIOS REQUERIDOS

FERRAMENTAS NECESSÁRIAS

1	TRAVESSA INFERIOR	x2
3	PÉ	x4
5	LATERAL ESQUERDA	x1
6	DIVISÃO ESQUERDA	x1
7	PRATELEIRA	x2
8	DIVISÃO DIREITA	x1
9	LATERAL DIREITA	x1

E		08
G		30
I		04
M		04
N		04
Q		04
S		

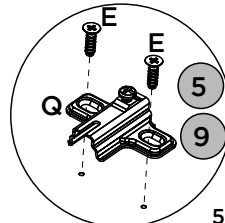
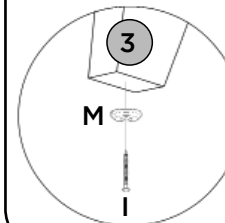
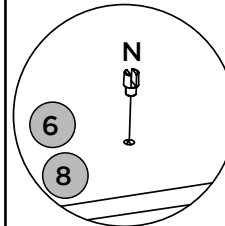
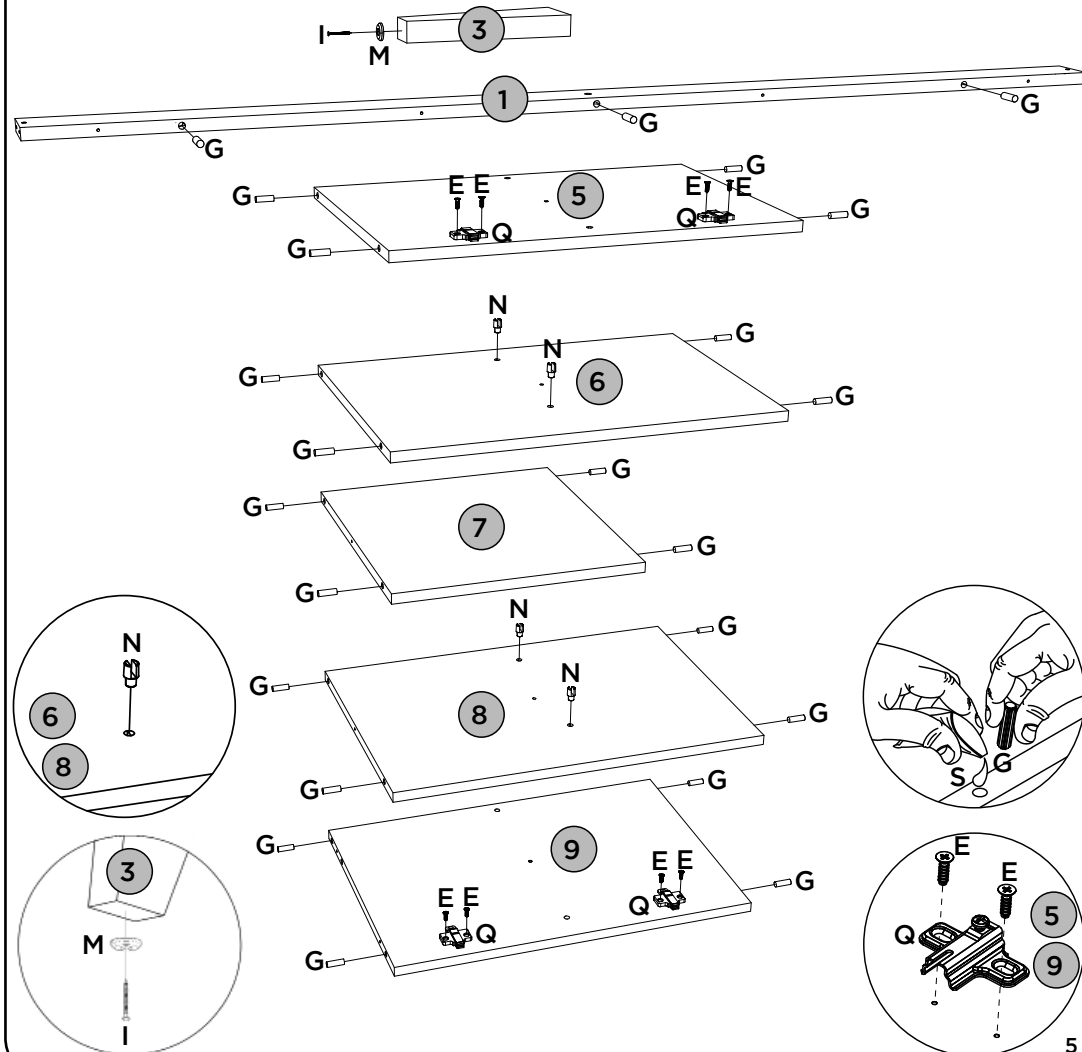
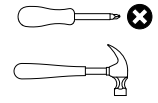



PASSO 2

ITM/S352-

PEÇAS REQUERIDAS

1	TRAVESSA INFERIOR	x2
2	TRAVESSA LATERAL	x2
3	PÉ	x4
4	BASE	x1

ACESSÓRIOS REQUERIDOS

A		26
B		04

FERRAMENTAS NECESSÁRIAS

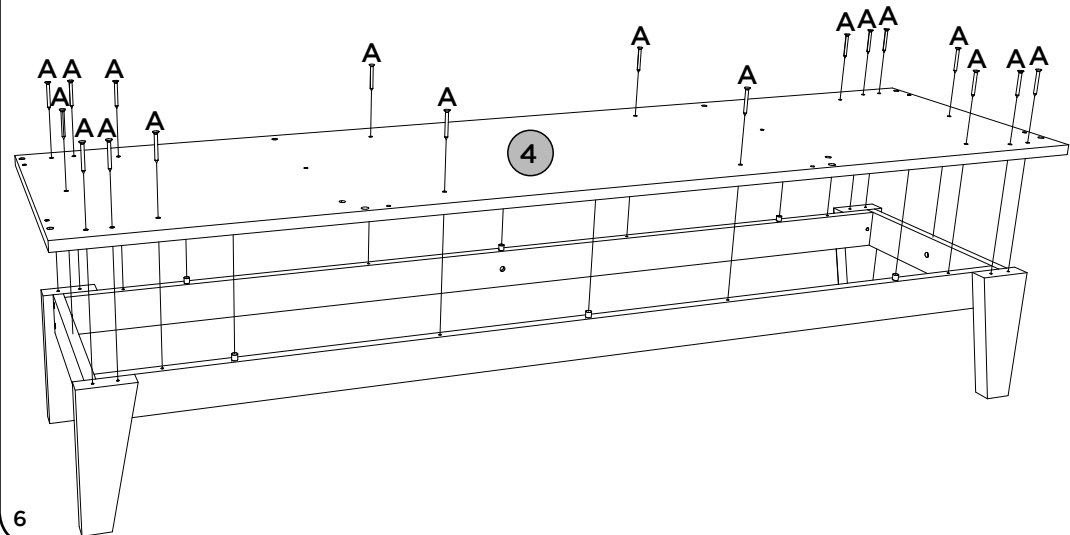
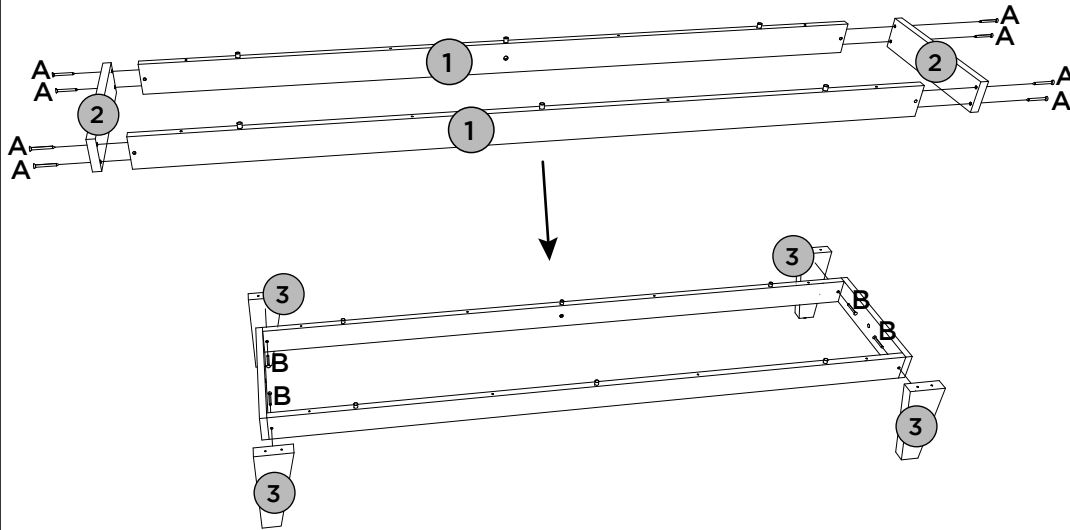
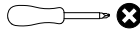



PASSO 3

ITM/S352-

PEÇAS REQUERIDAS

5	LATERAL ESQUERDA	x1
6	DIVISÃO ESQUERDA	x1
7	PRATELEIRA	x2
8	DIVISÃO DIREITA	x1
9	LATERAL DIREITA	x1

ACESSÓRIOS REQUERIDOS

A		04
S		

FERRAMENTAS NECESSÁRIAS

