



**MAVAULAR** móveis

**Fone (32) 3539-7600**

Rod. Ubá - Rodeiro, Km 03 - Galpão 1

C. P. 050 - CEP 36500-000 - Ubá - MG

E-mail: [mavaular@mavaular.com.br](mailto:mavaular@mavaular.com.br) - Site: [www.mavaular.com.br](http://www.mavaular.com.br)

**Mavaular Móveis**



## Instruções de Montagem Painel Lyon 1380/1828/2276mm

Assembly Instructions Panel Lyon

Instrucciones de montaje Panel Lyon

CÓDIGO: 11328/11330/11332

Atualizado em:  
16/03/2023

### CUIDE BEM DO SEU MÓVEL

Dicas de limpeza e conservação:

- Para limpar corretamente seu produto, use sempre um pano liso e **levemente** umedecido com água;
- Não se esqueça de enxugar o seu móvel! Ele não deve permanecer úmido, pois a água pode prejudicar o acabamento ou causar mofo na madeira;
- Não se recomenda o uso de produtos à base de amoníaco.
- Não utilize esponja de aço ou qualquer material que possa arranhar a superfície do produto durante a limpeza.
- Não utilize plásticos ou papéis coloridos para forrar seu móvel.
- Evite arrastar objetos em cima do móvel. Eles podem riscar e prejudicar o acabamento de seu móvel de
- O material dos seus móveis tem um tratamento contra fungos e cupins, mesmo assim, em ambientes infestados recomenda-se a dedetização antes de instalar a seu móvel;
- Tente evitar a exposição direta ao sol. Sugere-se utilização de cortinas para proteger seu móvel;

### TAKING GOOD CARE OF YOUR FURNITURE

Cleaning and caring instructions:

- Wipe the wood furniture down with a moist cloth to properly clean the furniture.
- Do not forget to dry your furniture out. Humidity can damage the finish or create mould.
- Chemical products are not recommended;
- Never clean the furniture with scouring powders, steel scrubber pads or any other product which can scratch its surface.
- Furniture surfaces should not be covered with colored plastic or paper sheets.
- Avoid dragging objects on top of the furniture. They might scratch the finishing.
- Wood furniture are made of mould and termites resistant materials, however, it is recommended to use termiticides in infested places before installing the furniture.
- Avoid furniture exposure to direct Sun light. Drapers suggested.

### CUIDE BIEN DE SU MUEBLE

Indicaciones de limpieza y conservación

- Para limpiar correctamente su muebles de madera, siempre use un paño húmedo.
- No se olvide de secar su muebles! No debe permanecer húmedo, pues el agua puede perjudicar el acabado o causar moho en la madera.
- No es recomendable utilizar productos con amoníaco.
- No utilizar esponjas de acero o cualquier material que dañe la superficie de los muebles.
- No utilizar plásticos o papeles coloridos para forrar los muebles.
- Evite arrastar objetos encima de los muebles. Ellos pueden riscar o dañar el acabado de su mueble de cocina.
- El material de los muebles tiene un tratamiento contra los hongos y las polillas, aun así, en ambientes infectados, se recomienda desinfectar antes de instalar su mueble.
- Evite la exposición directa al sol. Se sugiere la utilización de cortinas para proteger sus muebles.

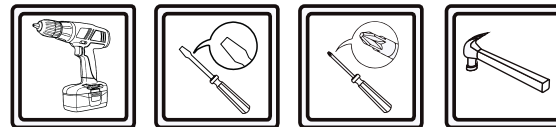
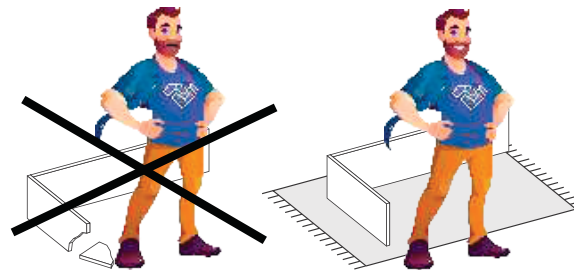

As ferramentas necessárias para montagem do produto não são fornecidas.  
The necessary tools for assembly aren't supplied.  
Las herramientas necesarias para armar los productos no son fornecidas.

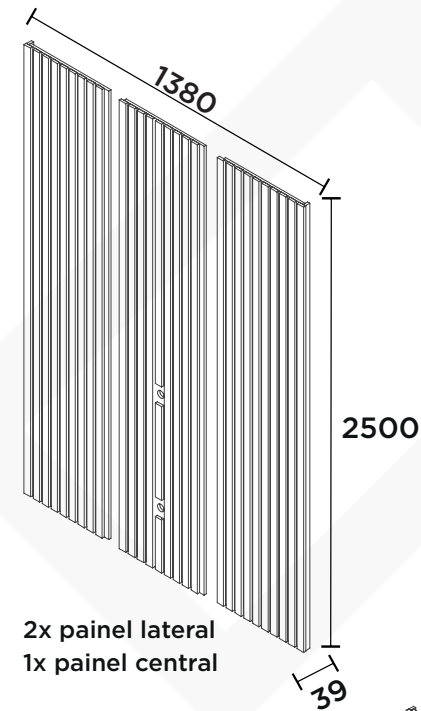

2x painel lateral  
1x painel central

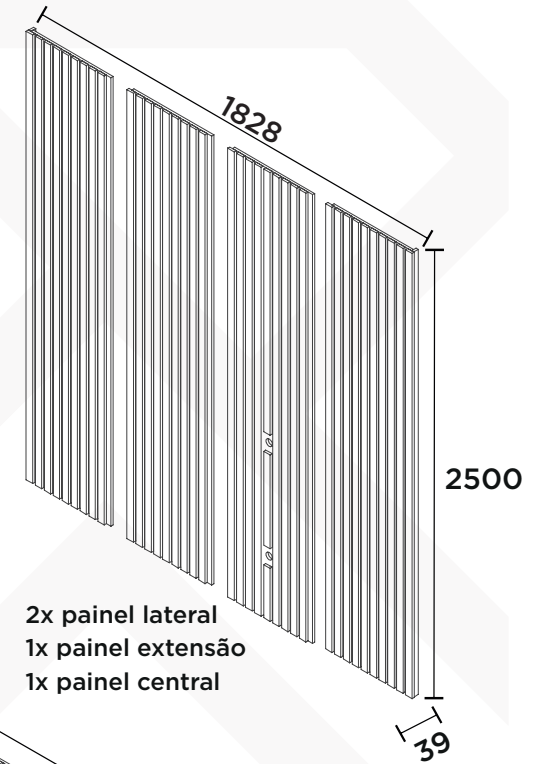

2x painel lateral  
1x painel extensão  
1x painel central

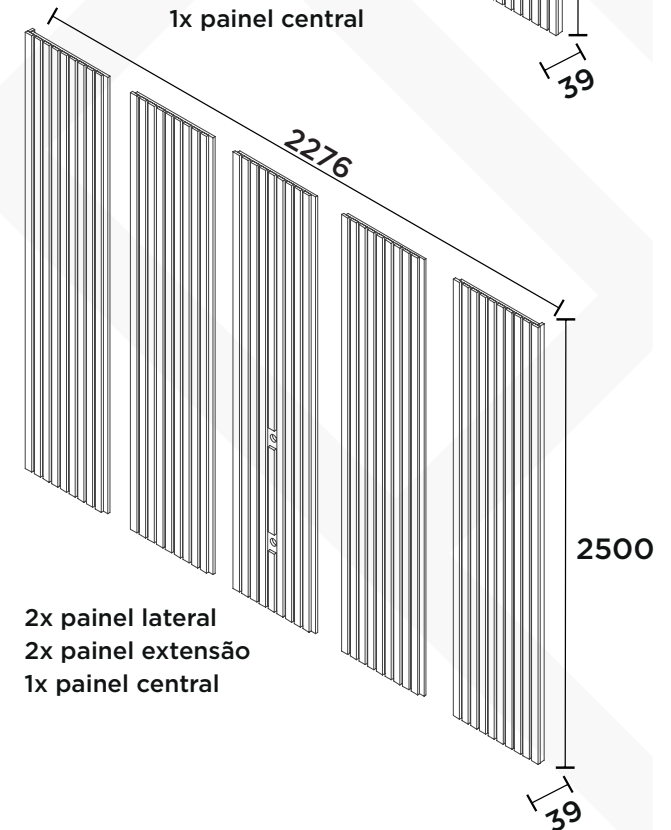

2x painel lateral  
2x painel extensão  
1x painel central

N°	CÓDIGO CODE CÓDIGO	DESCRIÇÃO DESCRIPTION DESCRIPCIÓN			DIMENSÃO (mm) DIMENSION (mm) DIMENSIÓN (mm)			QUANTIDADE QUANTITY CANTIDAD
					COMP. LEN. LON.	LARG. WID. ANC.	ESP. DEP. ESP.	
<b>PAINEL LATERAL 2500</b>								
1	11602	Painel lateral	Side panel	Panel lateral	2500	465	24	2
2	10814	Moldura do painel	Panel frame	Marco del panel	350	70	15	6
3	10723	Ripa acabamento da união	Union finishing frame	Marco de acabado de la unión	2500	36	12	1
4	11340	Gabarito	Spacer	Separador	1000	14	3	1
5	10820	Moldura fechamento lateral	Lateral closing frame	Marco de cierre lateral	2500	26	12	2
6	10815	Moldura da parede	Wall frame	Marco de pared	350	70	15	6
<b>PAINEL EXTENSÃO 2500</b>								
7	11603	Painel extensão	Extension panel	Panel de extensión	2500	465	24	1
2	10814	Moldura do painel	Panel frame	Marco del panel	350	70	15	3
6	10815	Moldura da parede	Wall frame	Marco de pared	350	70	15	3
<b>PAINEL CENTRAL 2500</b>								
8	11604	Painel com passa fio	Panel with wire pass	Panel de extensión	2500	465	24	1
2	10814	Moldura do painel	Panel frame	Marco del panel	350	70	15	3
6	10815	Moldura da parede	Wall frame	Marco de pared	350	70	15	3

### PAINEL LATERAL (x2)

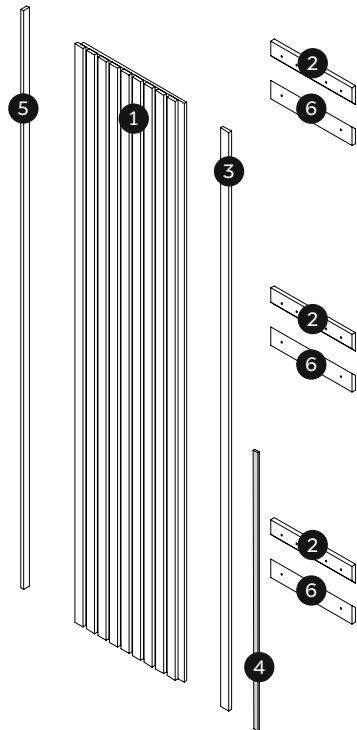

### PAINEL EXTENSÃO

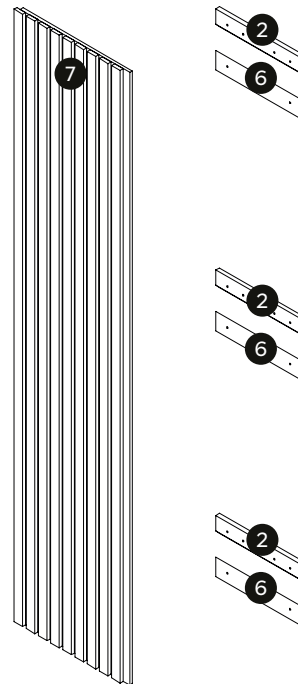

### PAINEL CENTRAL

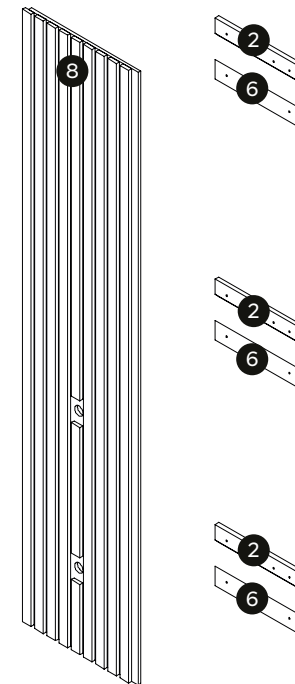

## PAINEL LATERAL (x2)

A - CAVILHA MADEIRA 6X25  
6X25 WOODEN DOWEL  
TARUGO DE MADEIRA 6X25 12

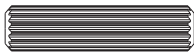

B - BUCHA DE NYLON 8mm  
NYLON WALL 8mm  
BUCHA DE NYLON 8mm 12



C - PARAFUSO 4,8X45MM  
4,8X45MM SCREW  
TORNILLO 4,8X45MM 12

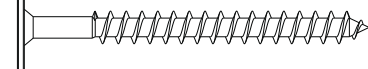

D - COLA BRANCA  
WHITE GLUE  
COLA BLANCA 02



E - PARAFUSO 4,0X22MM  
4,0X22MM SCREW  
TORNILLO 4,0X22MM 24

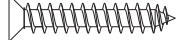

F - PARAFUSO 3,5X12MM  
3,5X12MM SCREW  
TORNILLO 3,5X12MM 28



G - CONECTOR  
CONNECTOR  
CONECTOR 14



## PAINEL CENTRAL

A - CAVILHA MADEIRA 6X25  
6X25 WOODEN DOWEL  
TARUGO DE MADEIRA 6X25 06

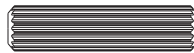

B - BUCHA DE NYLON 8mm  
NYLON WALL 8mm  
BUCHA DE NYLON 8mm 06

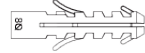

C - PARAFUSO 4,8X45MM  
4,8X45MM SCREW  
TORNILLO 4,8X45MM 06

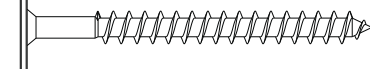

D - COLA BRANCA  
WHITE GLUE  
COLA BLANCA 01



E - PARAFUSO 4,0X22MM  
4,0X22MM SCREW  
TORNILLO 4,0X22MM 09

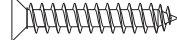

H - PASSA FIO  
WIRE THREADER  
PASSA FIO 02

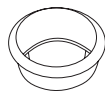

## PAINEL EXTENSÃO

A - CAVILHA MADEIRA 6X25  
6X25 WOODEN DOWEL  
TARUGO DE MADEIRA 6X25 06

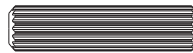

B - BUCHA DE NYLON 8mm  
NYLON WALL 8mm  
BUCHA DE NYLON 8mm 06



C - PARAFUSO 4,8X45MM  
4,8X45MM SCREW  
TORNILLO 4,8X45MM 06



D - COLA BRANCA  
WHITE GLUE  
COLA BLANCA 01



E - PARAFUSO 4,0X22MM  
4,0X22MM SCREW  
TORNILLO 4,0X22MM 09



## KIT OPCIONAL

I - PERFIL DIFUSOR  
DIFFUSER PROFILE  
PERFIL DIFUSOR 03

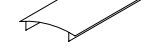

J - KIT LED 01



K - FIXADOR DE CABOS  
CABLE FIXER  
FIJADOR DE CABLES 03

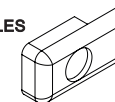

L - PARAFUSO 3,5X12MM  
3,5X12MM SCREW  
TORNILLO 3,5X12MM 03

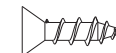

### ATENÇÃO!

Antes de iniciar a montagem, verificar se módulos adicionais foram adquiridos (prateleiras e/ou nichos). Caso tenham sido adquiridos, atentar na montagem na após a etapa 7.

### ATTENTION!

Before starting assembly, check whether additional modules have been purchased (shelves and/or niches). If they have been purchased, pay attention to the assembly after step 7.

### ¡ATENCIÓN!

Antes de iniciar el montaje, compruebe si se han adquirido módulos adicionales (estantes y/o nichos). Si se han comprado, prestar atención al montaje después del paso 7.

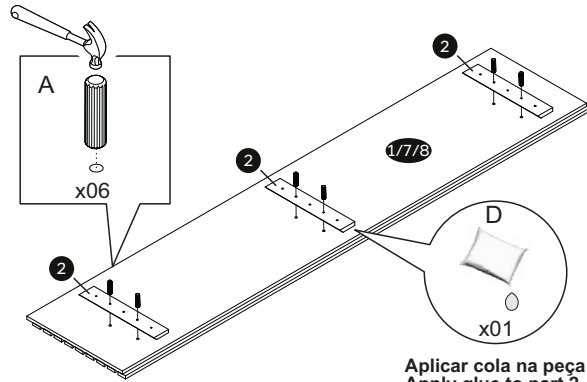
**1**

Aplicar cola na peça 2.  
Apply glue to part 2.  
Aplicar pegamento la pieza 2.

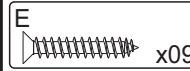
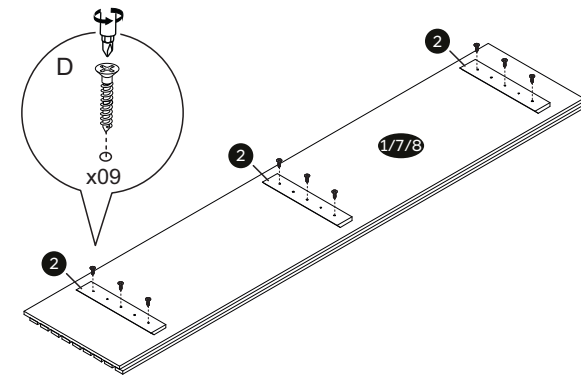
**2**

**3** **!** SOMENTE PARA PAINEL LATERAL  
ONLY FOR SIDE PANEL  
SOLO PARA PANEL LATERAL

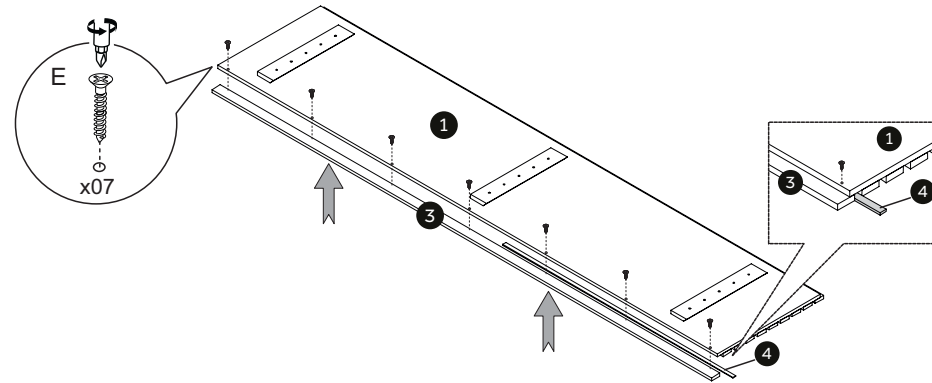

USAR O GABARITO PARA FIXAR  
CORRETAMENTE A PEÇA 3.

USE THE TEMPLATE TO CORRECTLY  
ATTACH PART 3.

UTILICE LA PLANTILLA PARA ADJUNTAR  
CORRECTAMENTE LA PARTE 3.

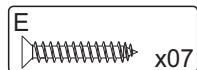

**4** **!** SOMENTE PARA PAINEL LATERAL  
ONLY FOR SIDE PANEL  
SOLO PARA PANEL LATERAL

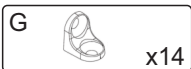
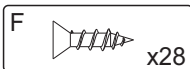
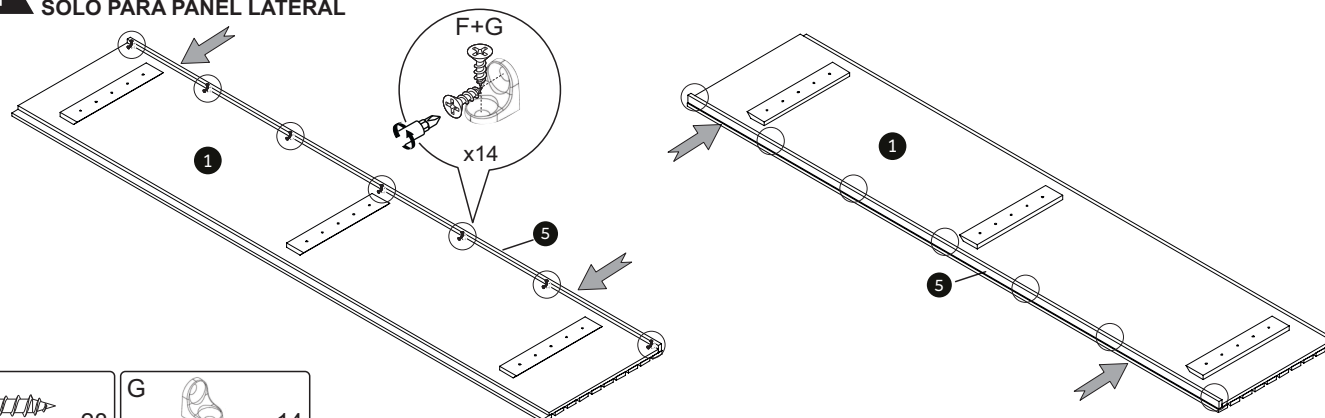
**5**

- Ø 8 mm (5/16 ").  
- ∇ 50mm (1.96 ").

**!**  
Atenção!  
Medida especificada entre  
os centro dos furos.

Attention!  
Specified measurement  
between the centers of  
the holes.

¡Atención!  
Medida especificada  
entre los centros de  
los agujeros.

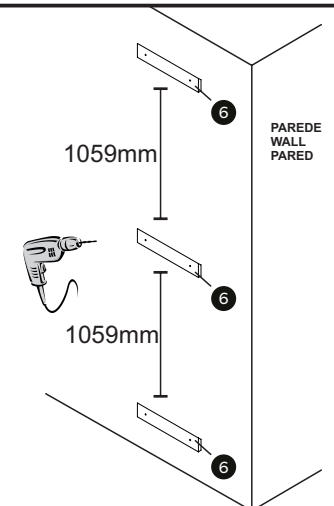

## 5.1

- Ø 8 mm (5/16 ").
- ▽ 50mm (1.96 ").



REPETIR A ETAPA 5 DE ACORDO COM A QUANTIDADE DE MÓDULOS ADQUIRIDOS.

REPEAT STEP 5 ACCORDING TO THE QUANTITY OF MODULES PURCHASED.

REPETIR EL PASO 5 SEGÚN LA CANTIDAD DE MÓDULOS COMPRADOS.

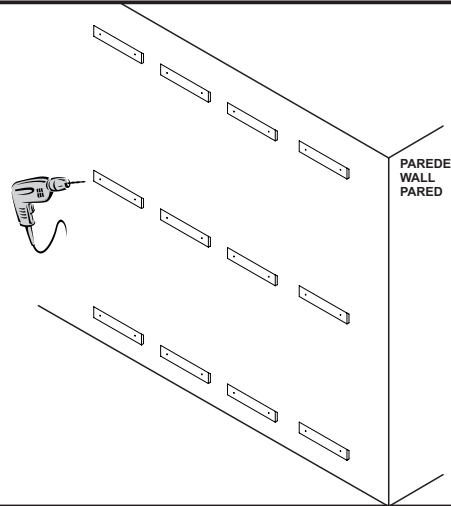

## 6

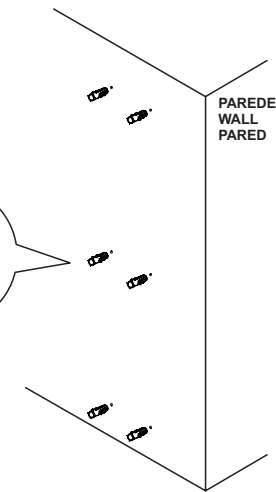
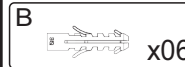
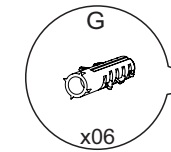

## 6.1

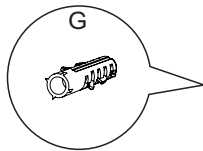

REPETIR A ETAPA 6 DE ACORDO COM A QUANTIDADE DE MÓDULOS ADQUIRIDOS.

REPEAT STEP 6 ACCORDING TO THE QUANTITY OF MODULES PURCHASED.

REPETIR EL PASO 6 SEGÚN LA CANTIDAD DE MÓDULOS COMPRADOS.

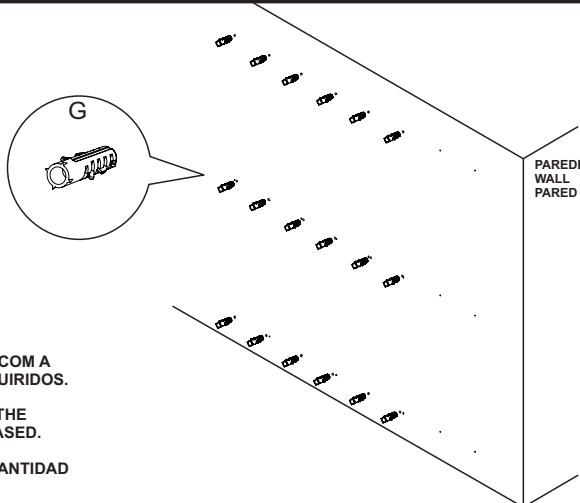

## 7

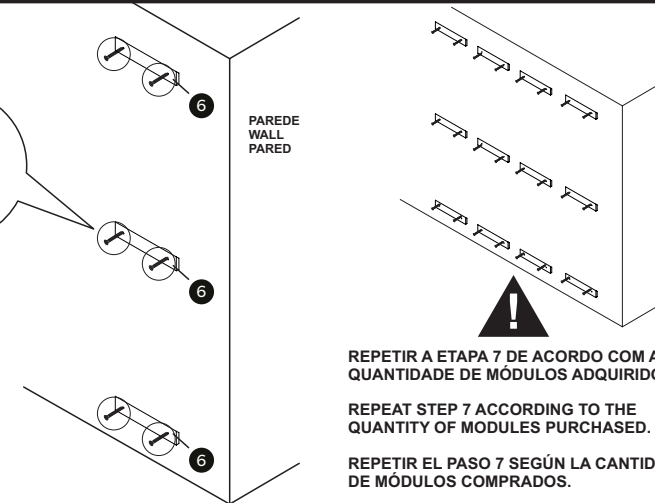
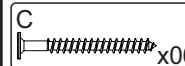
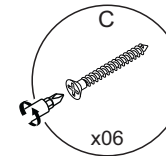

REPETIR A ETAPA 7 DE ACORDO COM A QUANTIDADE DE MÓDULOS ADQUIRIDOS.

REPEAT STEP 7 ACCORDING TO THE QUANTITY OF MODULES PURCHASED.

REPETIR EL PASO 7 SEGÚN LA CANTIDAD DE MÓDULOS COMPRADOS.



### ATENÇÃO!

Antes de seguir com a montagem, verificar se módulos adicionais foram adquiridos (prateleiras e/ou nichos). Caso tenham sido adquiridos, a partir de agora seguir o manual do módulo adicional.

### ATTENTION!

Before proceeding with the assembly, verify if additional modules were purchased (doors and/or niches). If they have been acquired, from now on follow the manual of the additional module.

### ¡ATENCIÓN!

Antes de seguir con un montaje, verifique los módulos adicionales para los adquiridos (prateleiras e/ou nichos). Caso tenham sido adquirido, a partir de agora seguir o manual do módulo adicional.

8



**SOMENTE PARA MONTAGEM COM KIT LED OPCIONAL.  
ONLY FOR ASSEMBLY WITH OPTIONAL LED KIT.  
SOLO PARA MONTAJE CON KIT LED OPCIONAL.**

RETIRE A PELÍCULA PROTETORA DA FITA DUPLA FACE E INICIE A COLAGEM DA FITA DE LED NO CANAL DA PEÇA 1.

REMOVE THE PROTECTIVE FILM FROM THE DOUBLE-SIDED TAPE AND START ATTACHING THE LED TAPE IN THE CHANNEL OF PART 1.

RETIRE LA PELÍCULA PROTECTORA DE LA CINTA DE DOBLE CARA Y COMIENCE A FIJAR LA CINTA LED EN EL CANAL DE LA PARTE 1.

Dica:  
Nessa etapa, passe todas as fiações necessárias.

Consejo:  
En este paso, pase todo el cableado necesario.

Tip:  
In this step, pass all the necessary wiring.

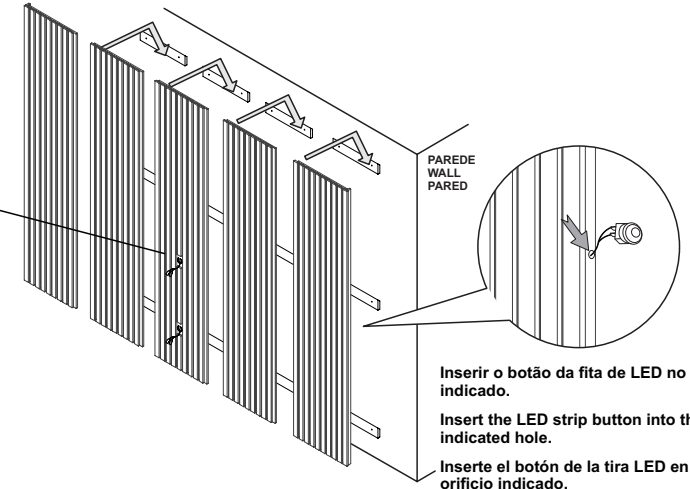
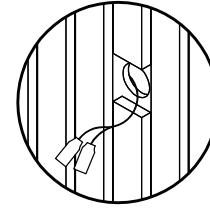
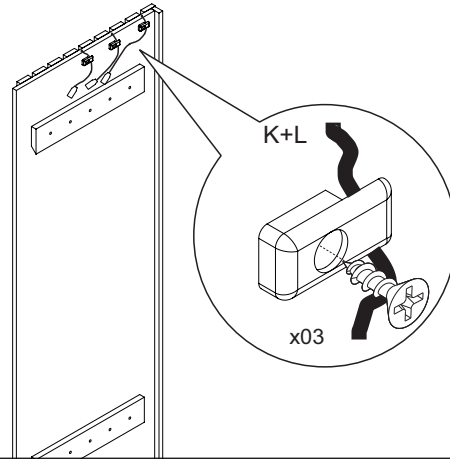
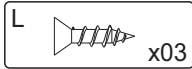
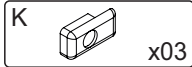

Inserir o botão da fita de LED no furo indicado.

Insert the LED strip button into the indicated hole.

Inserte el botón de la tira LED en el orificio indicado.

9

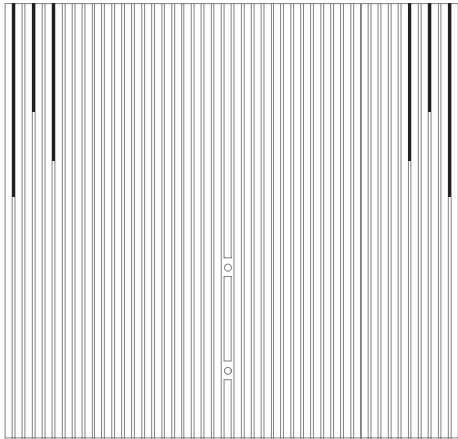

**KIT LED OPCIONAL**

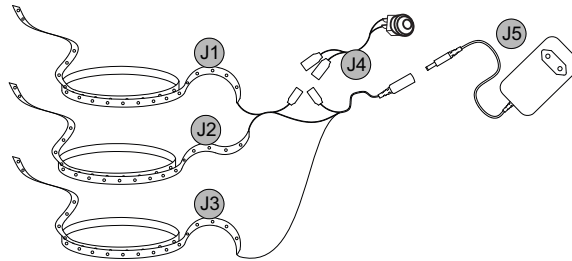

Instalado nos painéis laterais.  
Installed on the side panels.  
Instalado en los paneles laterales.

Após instalar a fita de Led. Encaixar o perfil de acabamento do Led.  
After installing the LED strip. Fit the LED finishing profile.  
Después de instalar la tira de LED. Montar el perfil de acabado LED.

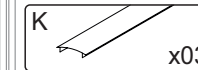
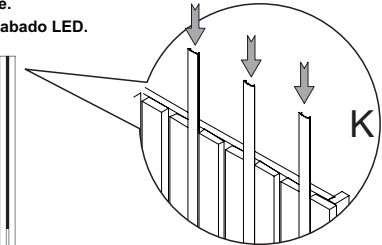
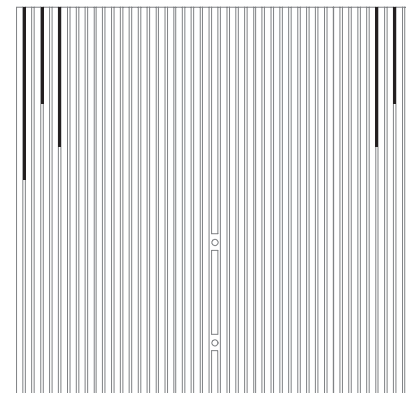

10

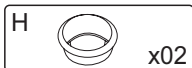
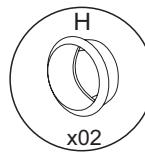
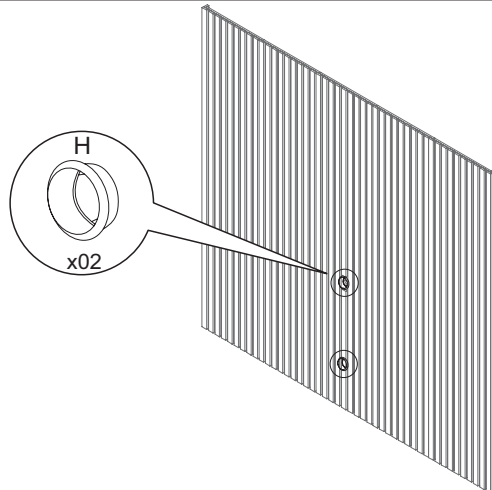

11

1380

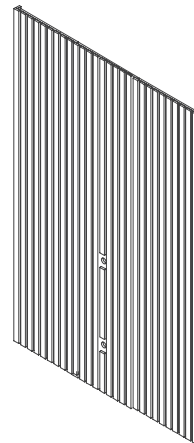

1828

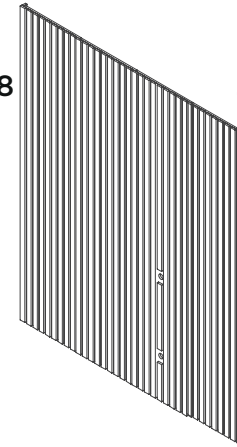

2276

