



**MAVAULAR** móveis

**Fone (32) 3539-7600**

Rod. Ubá - Rodeiro, Km 03 - Galpão 1

C. P. 050 - CEP 36500-000 - Ubá - MG

E-mail: [mavaular@mavaular.com.br](mailto:mavaular@mavaular.com.br) - Site: [www.mavaular.com.br](http://www.mavaular.com.br)

**Mavaular Móveis**



## Instruções de Montagem Rack Vitrum 2,18 / Rack Siena

Assembly Instructions Vitrum Tv stand

Instrucciones de montaje Soporte TV Vitrum

CÓDIGO: Vitrum 13238 / Siena 13124

Atualizado em:  
10/01/2023

### CUIDE BEM DO SEU MÓVEL

Dicas de limpeza e conservação:

- Para limpar corretamente seu produto, use sempre um pano liso e **levemente** umedecido com água;
- Não se esqueça de enxugar o seu móvel! Ele não deve permanecer úmido, pois a água pode prejudicar o acabamento ou causar mofo na madeira;
- Não se recomenda o uso de produtos à base de amoníaco.
- Não utilize esponja de aço ou qualquer material que possa arranhar a superfície do produto durante a limpeza.
- Não utilize plásticos ou papéis coloridos para forrar seu móvel.
- Evite arrastar objetos em cima do móvel. Eles podem riscar e prejudicar o acabamento de seu móvel de
- O material dos seus móveis tem um tratamento contra fungos e cupins, mesmo assim, em ambientes infestados recomenda-se a dedetização antes de instalar a seu móvel;
- Tente evitar a exposição direta ao sol. Sugere-se utilização de cortinas para proteger seu móvel;

### TAKING GOOD CARE OF YOUR FURNITURE

Cleaning and caring instructions:

- Wipe the wood furniture down with a moist cloth to properly clean the furniture.
- Do not forget to dry your furniture out. Humidity can damage the finish or create mould.
- Chemical products are not recommended;
- Never clean the furniture with scouring powders, steel scrubber pads or any other product which can scratch its surface.
- Furniture surfaces should not be covered with colored plastic or paper sheets.
- Avoid dragging objects on top of the furniture. They might scratch the finishing.
- Wood furniture are made of mould and termites resistant materials, however, it is recommended to use termiticides in infested places before installing the furniture.
- Avoid furniture exposure to direct Sun light. Drapers suggested.

### CUIDE BIEN DE SU MUEBLE

Indicaciones de limpieza y conservación

- Para limpiar correctamente su muebles de madera, siempre use un paño húmedo.
- No se olvide de secar su muebles! No debe permanecer húmedo, pues el agua puede perjudicar el acabado o causar moho en la madera.
- No es recomendable utilizar productos con amoníaco.
- No utilizar esponjas de acero o cualquier material que dañe la superficie de los muebles.
- No utilizar plásticos o papeles coloridos para forrar los muebles.
- Evite arrastrar objetos encima de los muebles. Ellos pueden riscar o dañar el acabado de su mueble de cocina.
- El material de los muebles tiene un tratamiento contra los hongos y las polillas, aun así, en ambientes infectados, se recomienda desinfectar antes de instalar su mueble.
- Evite la exposición directa al sol. Se sugiere la utilización de cortinas para proteger sus muebles.

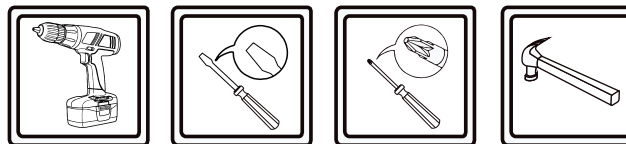
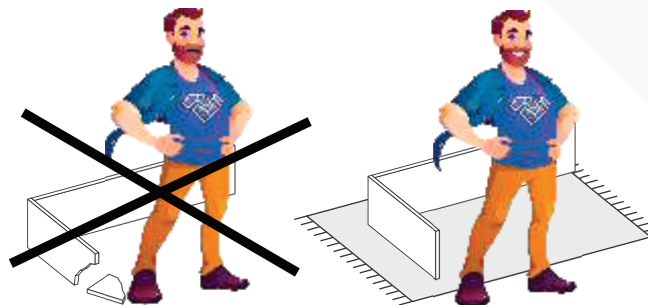
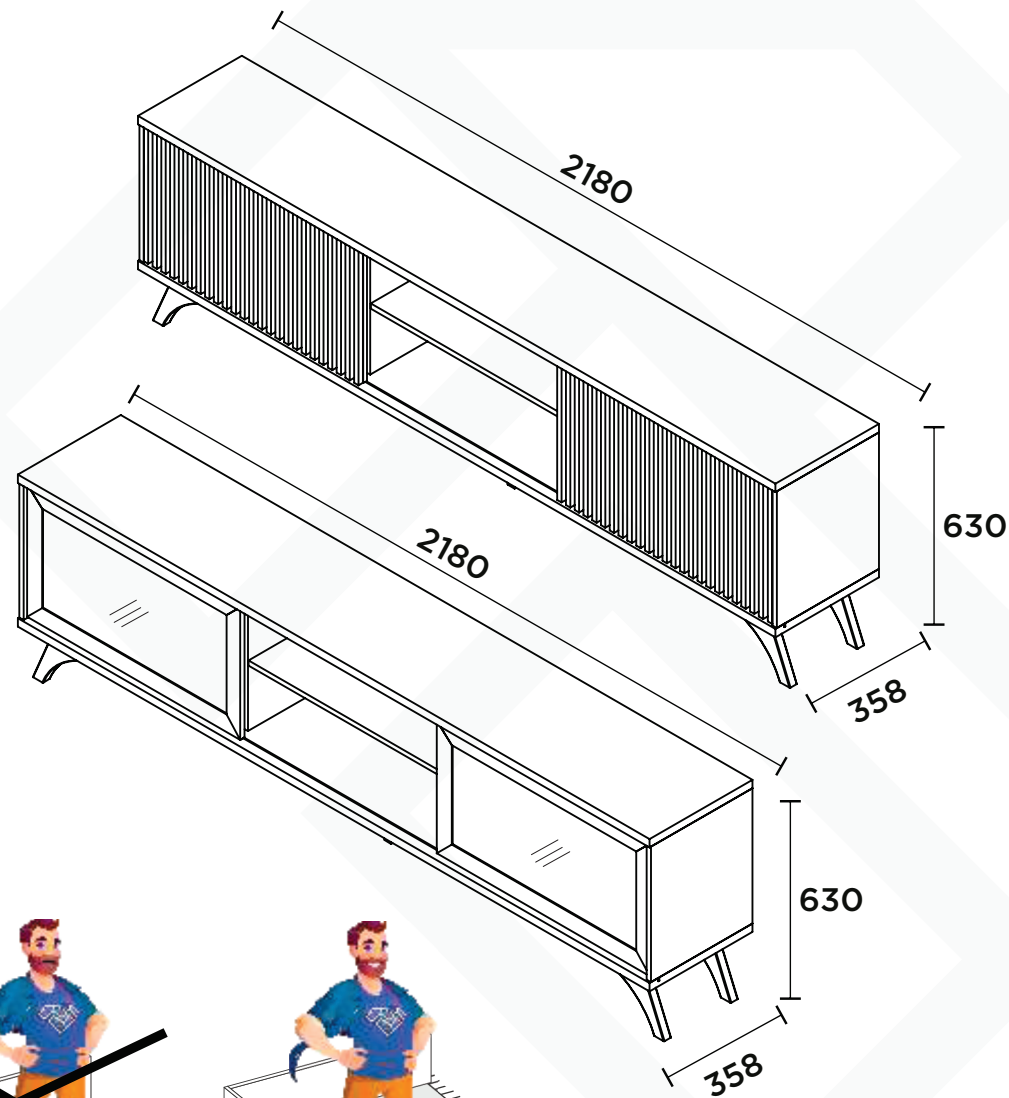







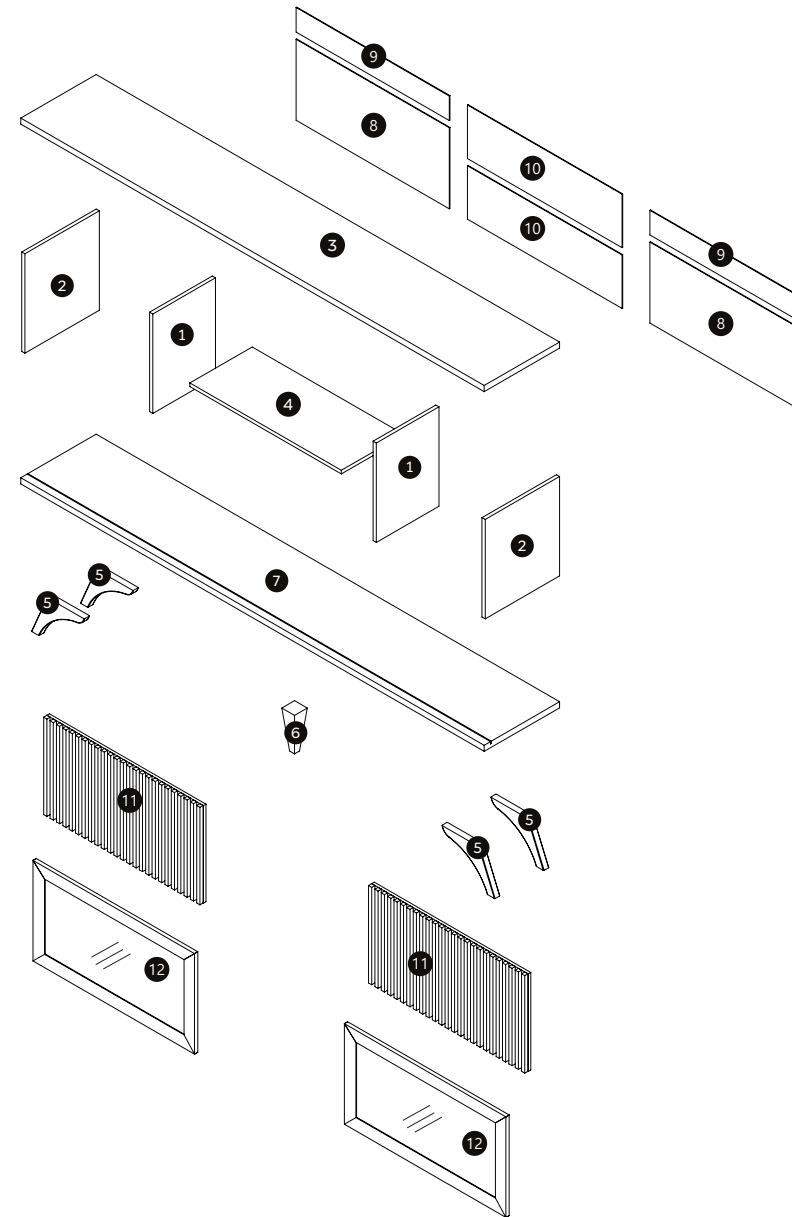

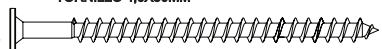

As ferramentas necessárias para montagem do produto não são fornecidas.  
The necessary tools for assembly aren't supplied.

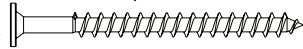
Las herramientas necesarias para armar los productos no son fornecidas.

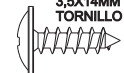
| N° | CÓDIGO<br>CODE<br>CÓDIGO | DESCRIÇÃO<br>DESCRIPTION<br>DESCRIPCIÓN |                 |                        | DIMENSÃO (mm)<br>DIMENSION (mm)<br>DIMENSIÓN (mm) |                       |                      | QUANTIDADE<br>QUANTITY<br>CANTIDAD |
|----|--------------------------|---|-----------------|------------------------|---|-----------------------|----------------------|------------------------------------|
|    |                          |   |                 |                        | COMP.<br>LEN.<br>LON.                             | LARG.<br>WID.<br>ANC. | ESP.<br>DEP.<br>ESP. |                                    |
| 1  | 12776                    | Divisão                                 | Division        | División               | 405   | 295                   | 15                   | 2                                  |
| 2  | 12775                    | Lateral                                 | Side            | Lado                   | 405   | 350                   | 15                   | 2                                  |
| 3  | 12779                    | Tampo                                   | Cover           | Tapa superior          | 2180  | 355                   | 25                   | 1                                  |
| 4  | 12777                    | Prateleira                              | Shelf           | Estante                | 691   | 293                   | 15                   | 1                                  |
| 5  | 10684                    | Pé de madeira                           | Wooden foot     | Pie de madera          | 200   | 100                   | 20                   | 4                                  |
| 6  | 9653                     | Pé central                              | Center foot     | Pie central            | 197   | 60                    | 60                   | 1                                  |
| 7  | 12778                    | Base                                    | Basis           | Base                   | 2180  | 355                   | 25                   | 1                                  |
| 8  | 12780                    | Costas lateral inferior                 | Lower side back | Parte inferior trasera | 732   | 330                   | 3                    | 2                                  |
| 9  | 12781                    | Costas lateral superior                 | Upper side back | Costa lateral superior | 732   | 100                   | 3                    | 2                                  |
| 10 | 12782                    | Costas central                          | Center back     | Costas central         | 706   | 218                   | 3                    | 2                                  |
| 11 | 11488                    | Porta                                   | Door            | Puerta                 | 736   | 395                   | 27                   | 2                                  |
| 12 | 12817                    | Porta de vidro                          | Glass door      | Puerta de vidrio       | 735   | 395                   | 20                   | 2                                  |

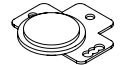
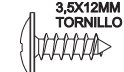
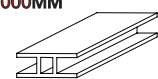
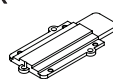
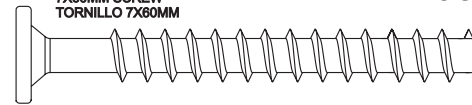
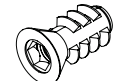

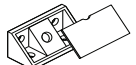
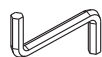
|   |           |   |           |  |           |
|---|-----------|---|-----------|--|-----------|
| <b>A1 - CAVILHA MADEIRA 6X30</b><br>6X30 WOODEN DOWEL<br>TARUGO DE MADEIRA 6X30<br> | <b>08</b> | <b>E1 - TAPA FURO ADESIVO 12MM</b><br>ADHESIVE HOLE COVER 12MM<br>TAPA AGUJERO ADHESIVO 12MM<br> | <b>04</b> | <b>I2 - CHAVE ZETA 6MM</b><br>6MM ALLEN WRENCH<br>LLAVE ZETA 6MM<br>      | <b>01</b> |
| <b>B1 - PARAFUSO 4,0X50MM</b><br>4,0X50MM SCREW<br>TORNILLO 4,0X50MM<br>            | <b>08</b> | <b>E2 - TAPA FURO 13MM</b><br>HOLE COVER 13MM<br>TAPA AGUJERO 13MM<br>                           | <b>05</b> | <b>I3 - GIZ PARA RETOQUE</b><br>TOUCH-UP CHALK<br>TIZA DE RETOQUE<br>     | <b>01</b> |
| <b>B2 - PARAFUSO 4,0X40MM</b><br>4,0X40MM SCREW<br>TORNILLO 4,0X40MM<br>           | <b>04</b> | <b>F1 - PREGO 10X10</b><br>NAIL<br>CLAVO<br>  | <b>30</b> | <b>I4 - CANTONEIRA 2 FUROS</b><br>CORNER<br>ESQUINA<br>                  | <b>05</b> |
| <b>B3 - PARAFUSO 3,5X14MM</b><br>3,5X14MM SCREW<br>TORNILLO 3,5X14MM<br>          | <b>26</b> | <b>G1 - FIXADOR DE COSTAS</b><br>BACK FIXER<br>FIJADOR DE ESPALDA<br>                          | <b>10</b> | <b>I5 - ROLDANA</b><br>PULLEY<br>POLEA<br>                              | <b>04</b> |
| <b>B4 - PARAFUSO 3,5X12MM</b><br>3,5X12MM SCREW<br>TORNILLO 3,5X12MM<br>          | <b>20</b> | <b>H1 - PERFIL H 0000MM</b><br>H PROFILE<br>PERFIL H<br>                                       | <b>02</b> | <b>I6 - GUIA SUPERIOR</b><br>TOP GUIDE<br>GUÍA SUPERIOR<br>             | <b>04</b> |
| <b>B5 - PARAFUSO 7X60MM</b><br>7X60MM SCREW<br>TORNILLO 7X60MM<br>                | <b>05</b> | <b>I7 - BUCHA DO PÉ</b><br>BUSHING<br>COJINETE<br>   | <b>05</b> | <b>I8 - SAPATA REGULÁVEL</b><br>ADJUSTABLE SHOE<br>ZAPATO AJUSTABLE<br> | <b>05</b> |
| <b>C1 - CONECTOR PLÁSTICO</b><br>PLASTIC CONNECTOR<br>CONECTOR PLASTICO<br>      | <b>04</b> | <b>I1 - CHAVE ZETA 4MM</b><br>4MM ALLEN WRENCH<br>LLAVE ZETA 4MM<br>                           | <b>01</b> |  |           |

**1**

A1 x08

**2**

B3 x16 C1 x04

**4**

B2 x04

**5**

12 + 17 x05

17 x05 12 x01 18 x05

17 x05 12 x01 18 x05

**6**

B5 x05 I1 x01 E2 x05

B5 + I1 + E2 x05

**7**

B3 x10 I4 x05

**8**

B1 x08

**9**

F1 x30 H1 x02 G1 x10

10

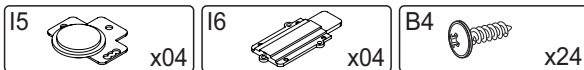
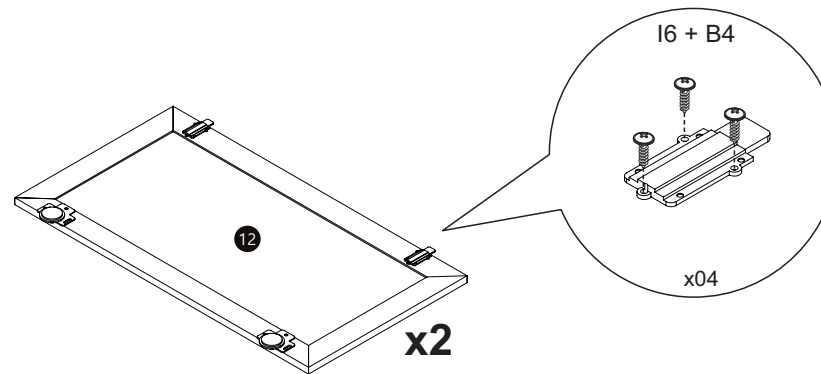
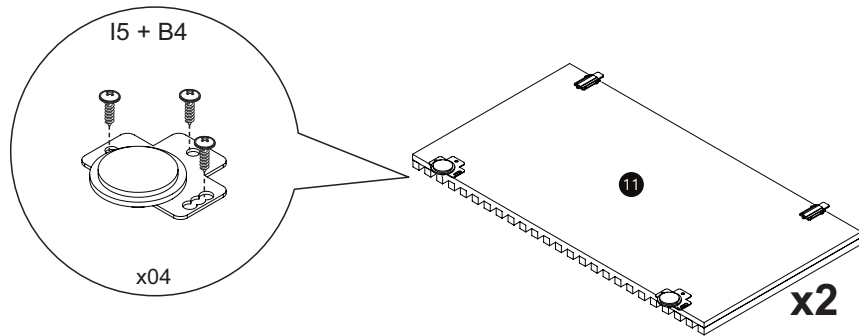

11 Inserir as portas nos trilhos.

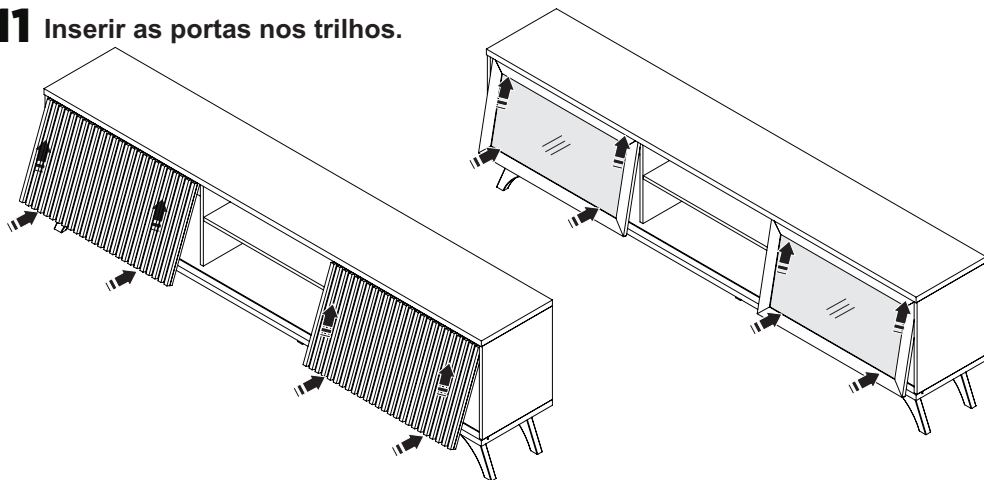

12

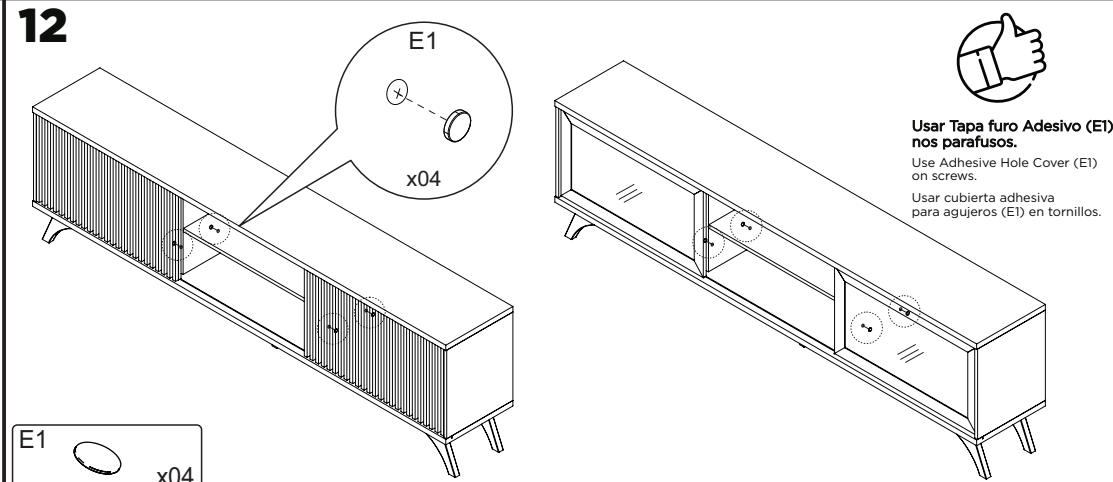

13

