











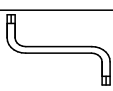
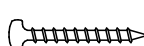







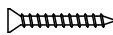

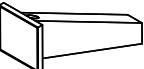





LISTA DE PEÇAS / LISTA DE PIEZAS

| PEÇA / PIEZA | ITEM | DIMENSÕES | CÓDIGO | QTD. |
|-----------------------------------|------|-----------------|--------|------|
| BASE / BASE | ① | 1360 X 360 X 15 | 70730 | 01 |
| LATERAL DIREITA / LADO DERECHA | ② | 765 X 360 X 15 | 70734 | 01 |
| LATERAL ESQUERDA / LADO IZQUIERDA | ③ | 765 X 360 X 15 | 70733 | 01 |
| DIVISÃO / DIVISÓN | ④ | 663 X 358 X 15 | 70732 | 01 |
| PRATELEIRA / REPISA | ⑤ | 1327 X 359 X 15 | 70731 | 01 |
| PRATELEIRA / REPISA | ⑥ | 874 X 340 X 15 | 70737 | 01 |
| PRATELEIRA / REPISA | ⑦ | 438 X 340 X 15 | 70738 | 01 |
| PILASTRA / PILASTRA | ⑧ | 1327 X 85 X 15 | 70735 | 01 |
| PORTA / PUERTA | ⑨ | 655 X 432 X 15 | 70736 | 03 |
| COSTA / FONDO | ⑩ | 1347 X 341 X 3 | 70739 | 02 |

LISTA DE ACESSÓRIOS

| ACESSÓRIO | ITEM | QTD | (A) | (I) |
|----------------------------|------|-----|--|---|
| PARAFUSO ALLEN 5X50 | (A) | 12 |  |  |
| CHAVE Z ALLEN 3 MM | (B) | 01 |  |  |
| CAVILHA 8 X 30 | (C) | 06 |  |  |
| CAVILHA 8 X 55 | (D) | 02 |  |  |
| GARRA MET. P/ COSTA | (E) | 05 |  |  |
| SUPORTE PRAT 8X7 | (F) | 08 |  |  |
| PARAFUSO CHATA 4X20 | (G) | 20 |  |  |
| PARAFUSO PAINEL 3,5X14 | (H) | 24 |  |  |
| PREGO 10X10 | (I) | 40 |  |  |
| PARAFUSO PAINEL 3,5X30 | (J) | 09 |  |  |
| CALÇO DE DOBRADIÇA | (K) | 06 |  |  |
| CANECO DE DOBRADIÇA | (L) | 06 |  | |
| TAMBOR DE MINIFIX | (M) | 02 |  |  |
| ASTE DE MINIFIX | (N) | 02 |  |  |
| PUXADOR BARRA 320mm(70749) | (O) | 03 |  |  |
| PÉ PLÁSTICO RETRÔ (63151) | (P) | 05 |  |  |

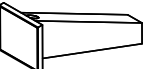
1. Leia atentamente toda instrução antes de iniciar a montagem.
2. A montagem do produto deverá ser feita em uma superfície limpa e plana. Aconselhamos utilizar a própria embalagem para forrar o chão a fim de não danificar o produto.
3. Reservar área livre para montagem do produto.
4. Evitar batidas e o contato com objetos cortantes.

1. Lea todas las instrucciones cuidadosamente antes de comenzar el ensamblaje.
2. El producto debe montarse en una superficie limpio y plano, le recomendamos que utilice el embalaje en sí para forre el piso - para no dañar el producto.
3. Reserve un área libre para el ensamblaje del producto.
4. Evite golpes y contacto con objetos afilados.

FERRAMENTAS NÃO FORNECIDAS:
HERRAMIENTAS NO PROPORCIONADAS:

NECESSÁRIO 1 PESSOA PARA MONTAGEM
1 PERSONA REQUERIDA PARA LA ASAMBLEA

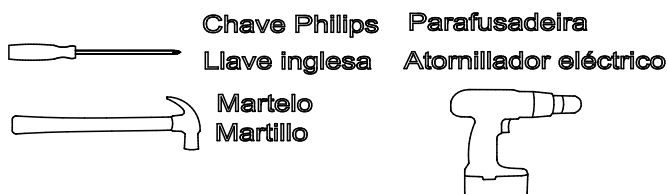

**IDENTIFICAÇÃO DE PEÇA
IDENTIFICACIÓN DE PIEZAS**

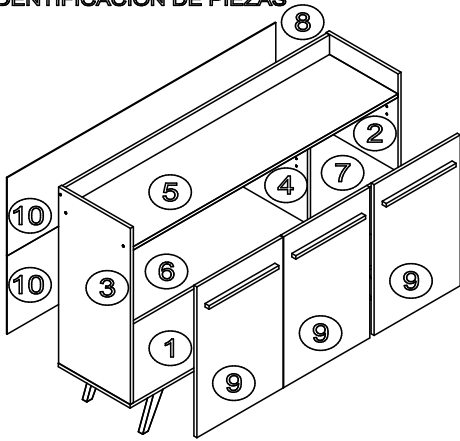

**PASSO 1
PASO 1**

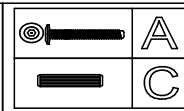
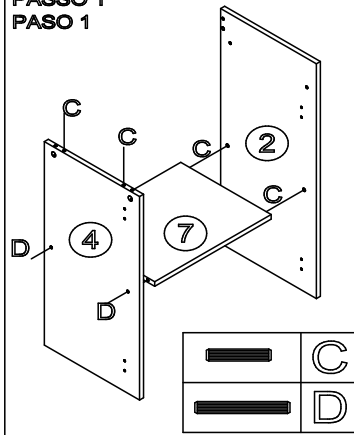

**PASSO 2
PASO 2**

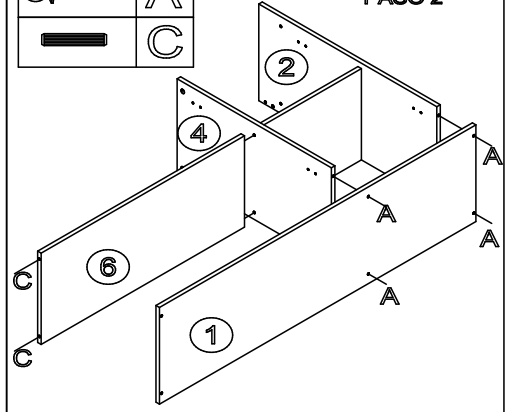

**PASSO 2
PASO 2**

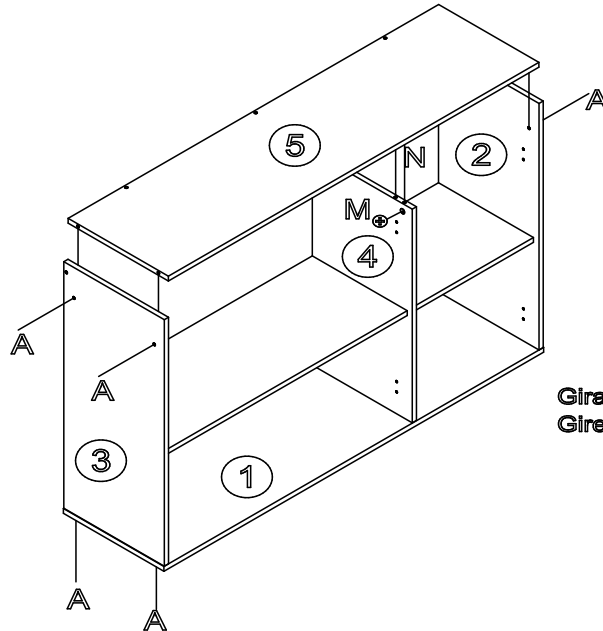
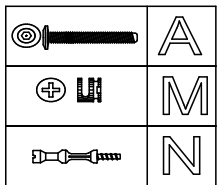

Girar tambor (M) sentido horário
Gire el tambor (M) en sentido horario

**PASSO 3
PASO 3**

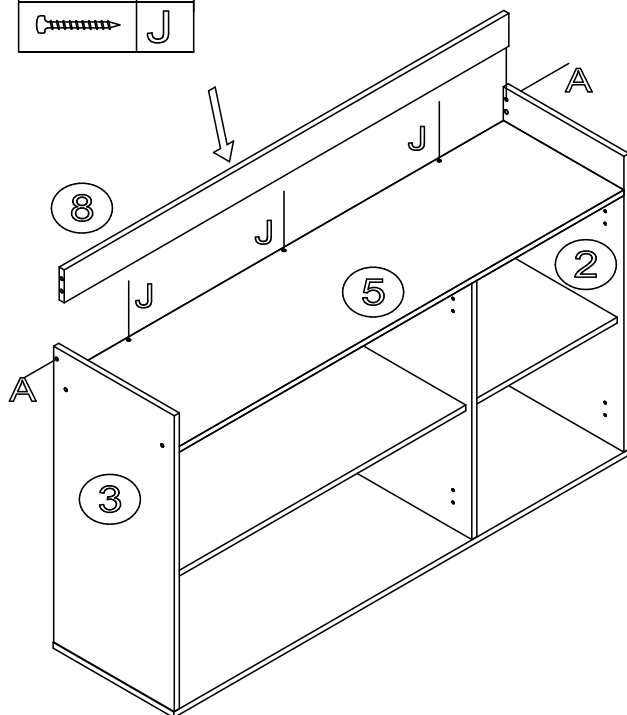
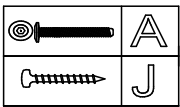

**PASSO 4
PASO 4**

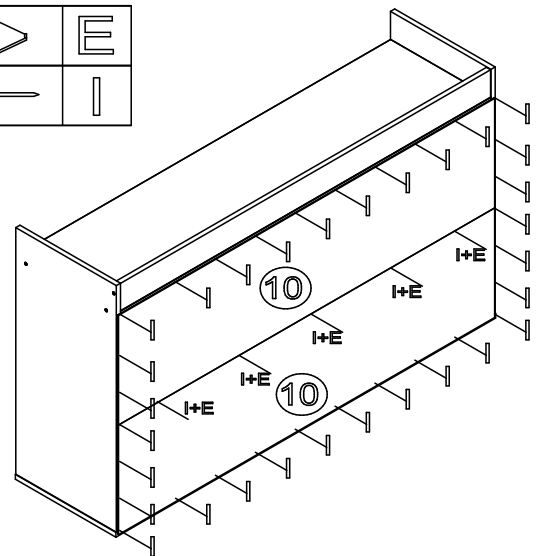
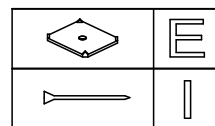

VISTA TRASEIRA / VISTA TRASERA

PASSO 5
PASO 5

PARAFUSAR OS PÉS (P) COM (G)
TORNILLE LOS PIES (P) CON (G)

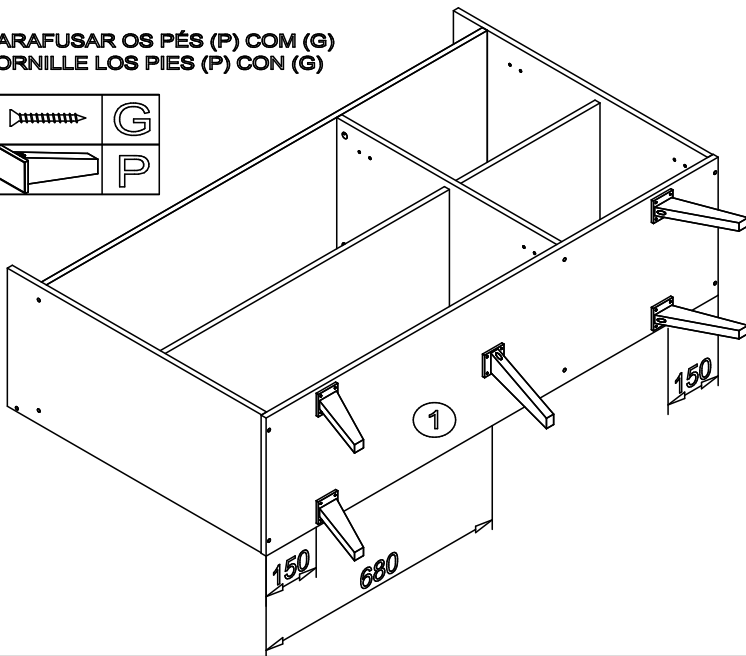
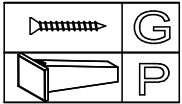

Passo 6
Paso 6

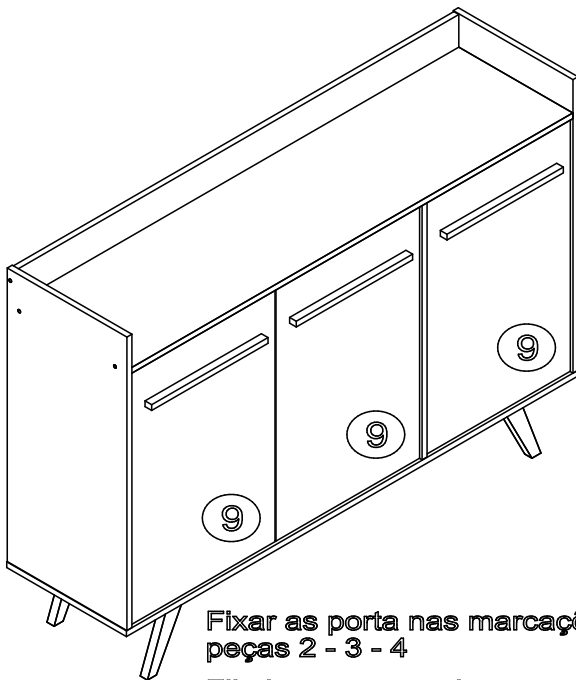
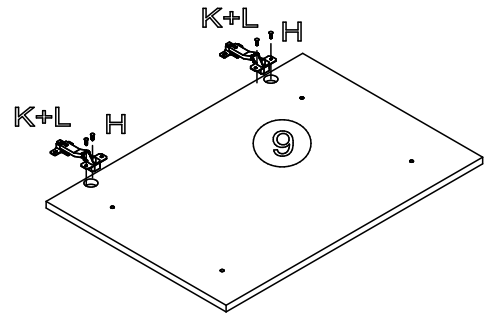
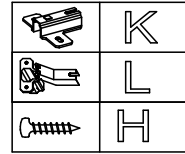

Usar as pré furações das portas como guia de fixação do puxador, atentar à posição das portas(9) sendo 2 abertura direita e 1 à esquerda.

Use los agujeros previos de la puerta como manejar la guía de fijación, prestar atención a posición de las puertas (8), siendo 2 la apertura derecha y 1 a la izquierda

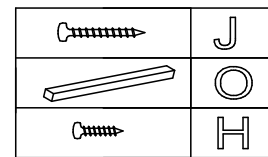
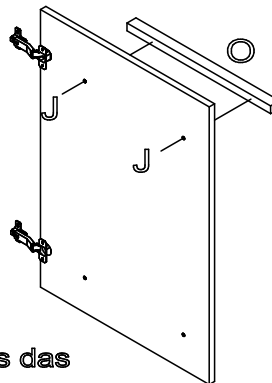

Fixar as porta nas marcações das peças 2 - 3 - 4

Fije las puertas a las marcas en las partes 2 - 3 - 4

ASPECTO FINAL

