

Pronto!! Sua POLTRONA está montada.

Listo !! Su producto está ensamblado.. | Ready !! Your product is assembled.

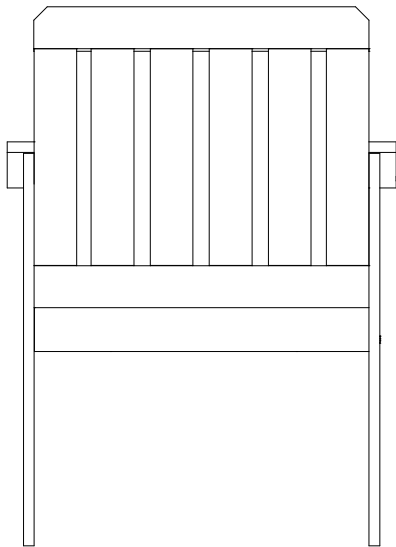

Frontal
Frontal/ Front

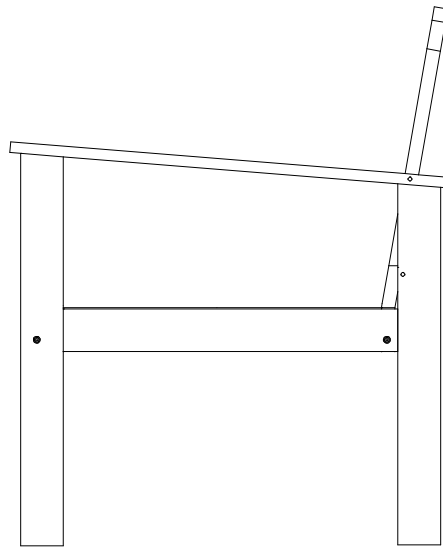

Lateral
Lateral/ Side

PRODUTO FABRICADO NO BRASIL.

EU AMO A NATUREZA



MANUAL DE MONTAGEM

Manual del producto/ User's Guide

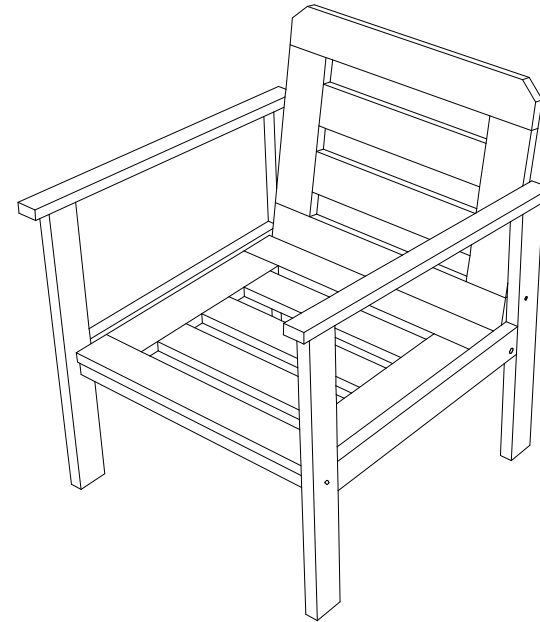

Ref. 050S / 050P



Montagem 2 pessoas



Parafusadeira/
Chave philips



Tempo: 20 minutos

Importante!

Importante/ Important

- 1 - Monte todos os itens com atenção.
- 2 - Monte seu produto em uma superfície limpa e plana. Para não danificar seu produto, aconselhamos utilizar a embalagem ou um tapete para forrar o chão.
- 3 - Aperte bem os parafusos.
- 4 - Verifique periodicamente para que as partes não estejam soltas. Nestes casos precisam ser reapertados.

- 1 - Reúne todos los artículos cuidadosamente.
- 2 - Monte su producto sobre una superficie limpia y plana. Para no dañar su producto, le recomendamos que utilice el embalaje o una alfombra.
- 3 - Ajuste los tornillos.
- 4 - Revise periódicamente para comprobar no son puestos en libertad. En estos casos hay que volver a apretar.

- 1 - Assemble all items carefully.
- 2 - Mount your product on a clean, flat surface. In order not to damage your product, we advise you to use the packaging or a floor mat.
- 3 - Tighten well the screws.
- 4 - Check periodically for loose joints i.E screws need tightening.

LISTA DE PEÇAS
Lista de piezas/ Parts List

ITEM Artículo/ Article	DESCRIÇÃO Descripción/ Description	QUANTIDADE Cantidad/ Amount
A	 1/4X70 mm	4
B	 PORCA	4
C	 CANTONEIRA	10
D	 CHAVE ALLEN	1
E	 4x40 mm	2
F	 4x16 mm	20
G	 5x60 mm	2

ITEM Artículo/ Article	DESCRIÇÃO Descripción/ Description	QUANTIDADE Cantidad/ Amount
1	Assento	1
2	Pé	2
3	Encosto	1
4	Travessa	2

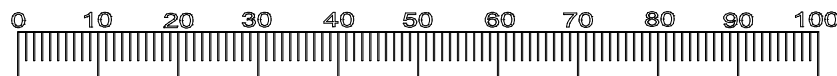

Utilize esta régua para medir as ferragens (medidas em mm)

1 PASSO
PASO
STEP

Ferramentas
Herramientas/ Tools

D | 
Peças
Piezas/Parts

A | 
B | 

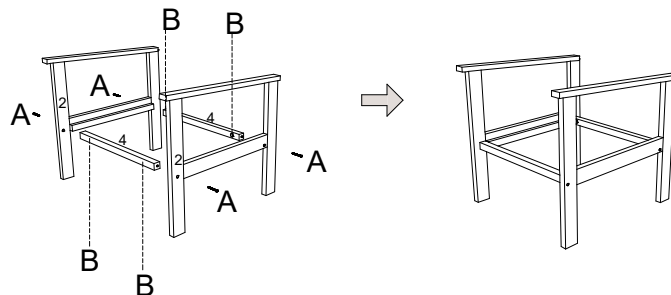

2 PASSO
PASO
STEP

Ferramentas
Herramientas/ Tools

 Parafusadeira/
Chave Philips
Peças
Piezas/Parts

C | 
F | 

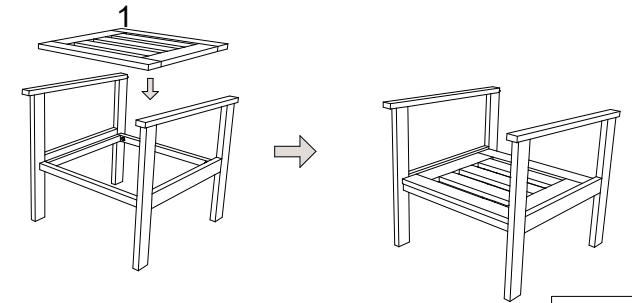

Obs: Vire a cadeira

C - Total: 8 Cantoneiras

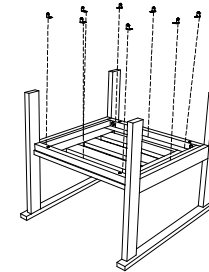

F - Total: 16 (4/16mm)

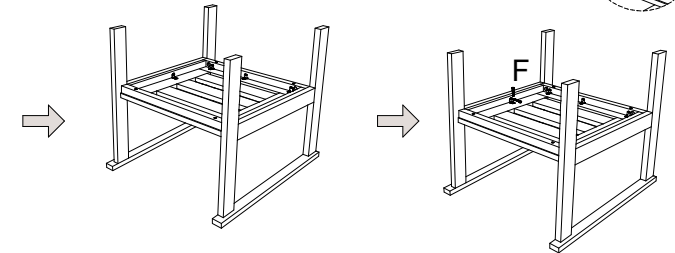
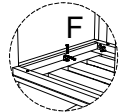

3 PASSO
PASO
STEP

Ferramentas
Herramientas/ Tools

 Parafusadeira/
Chave Philips
Peças
Piezas/Parts

C | 
E | 
F | 
G | 

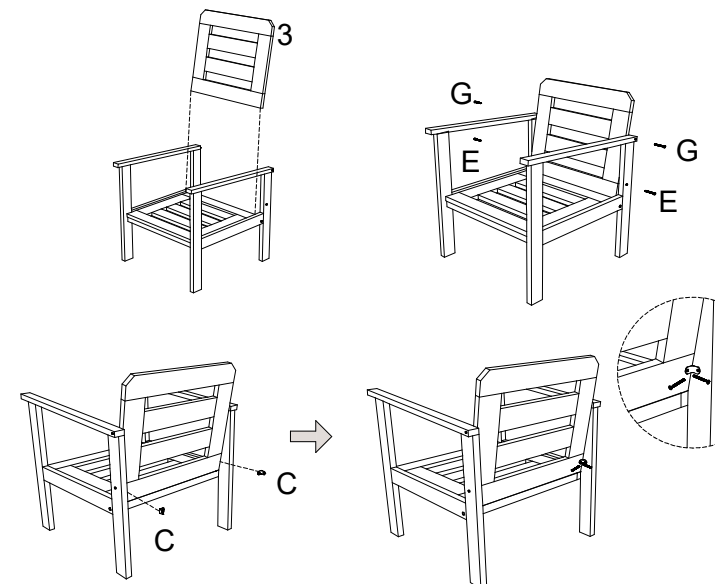

C - Total: 2 Cantoneiras

F - Total: 4 (4/16mm)

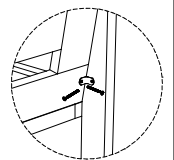

Agora que você já comprou o seu móvel, ele merece ser montado do jeito certo.

Erros de montagem causam mais de **60%** dos danos em móveis.

Por que **contratar?**

Tranquilidade do **início ao fim** da montagem



PROFISSIONAIS QUALIFICADOS

Especialistas certificados na **MadeiraMadeira Serviços**.



FERRAMENTAS PROFISSIONAIS

que **protegem** seus móveis.



AGENDAMENTO EM 24 HORAS

escolha a data e o turno **ideais para** você.



GARANTIA DE 3 MESES

de cobertura **completa**.

Mais de 1 MILHÃO DE MONTAGENS
★ com avaliação **4.7** ★

Mariana S., São Paulo

"Chegaram no horário e montaram tudo rapidamente. Serviço incrível!"



Carlos R., Belo Horizonte

"Tentei montar sozinho e foi um desastre. Com a **MadeiraMadeira Serviços** ficou perfeito."



Ana P., Rio de Janeiro

"Agendamento ágil e **montagem pontual e perfeita**. Recomendo demais!"



Agende agora pelo QR Code

Madeira**Madeira** Serviços · Atendimento em todo o Brasil



Escaneie o QRCode