

**SOFÁ CAMA
TÓKIO**

V1 - 12/04/2022

Informações Utéis

Para assegurar a garantia, é recomendada a prévia conferência das peças e componentes, bem como a leitura do manual de montagem.

Qualquer dúvida sobre os nossos produtos você pode entrar em contato via nosso canal de atendimento:

Limpeza

- Para começar a limpeza, retire o pó com flanela seca, depois use um pano macio, levemente umedecido com água. É possível o uso de detergente neutro, ou sabão neutro com água;
- De tempos em tempos, reaperte os parafusos do produto para garantir sua estabilidade e durabilidade;
- Tenha cuidado com a disposição de aparelhos eletrônicos sobre o móvel, a falta de ventilação e excesso de calor podem prejudicar a durabilidade e acabamento do seu produto.

Para mais dicas amigas e inspirações de decoração acesse nosso blog: <https://www.madeiramadeira.com.br/central-de-dicas>

Siga MadeiraMadeira:



[madeiramadeira.com.br](https://www.madeiramadeira.com.br)

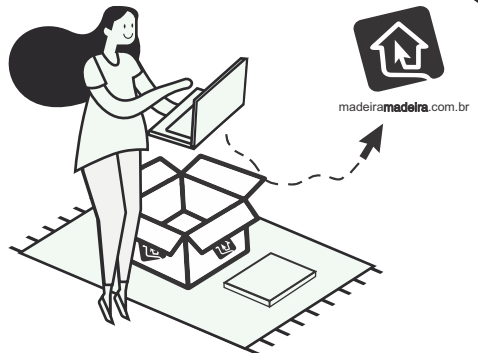
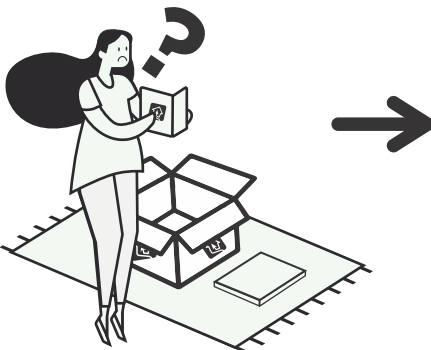
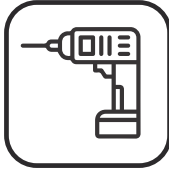

madeira madeira.com.br

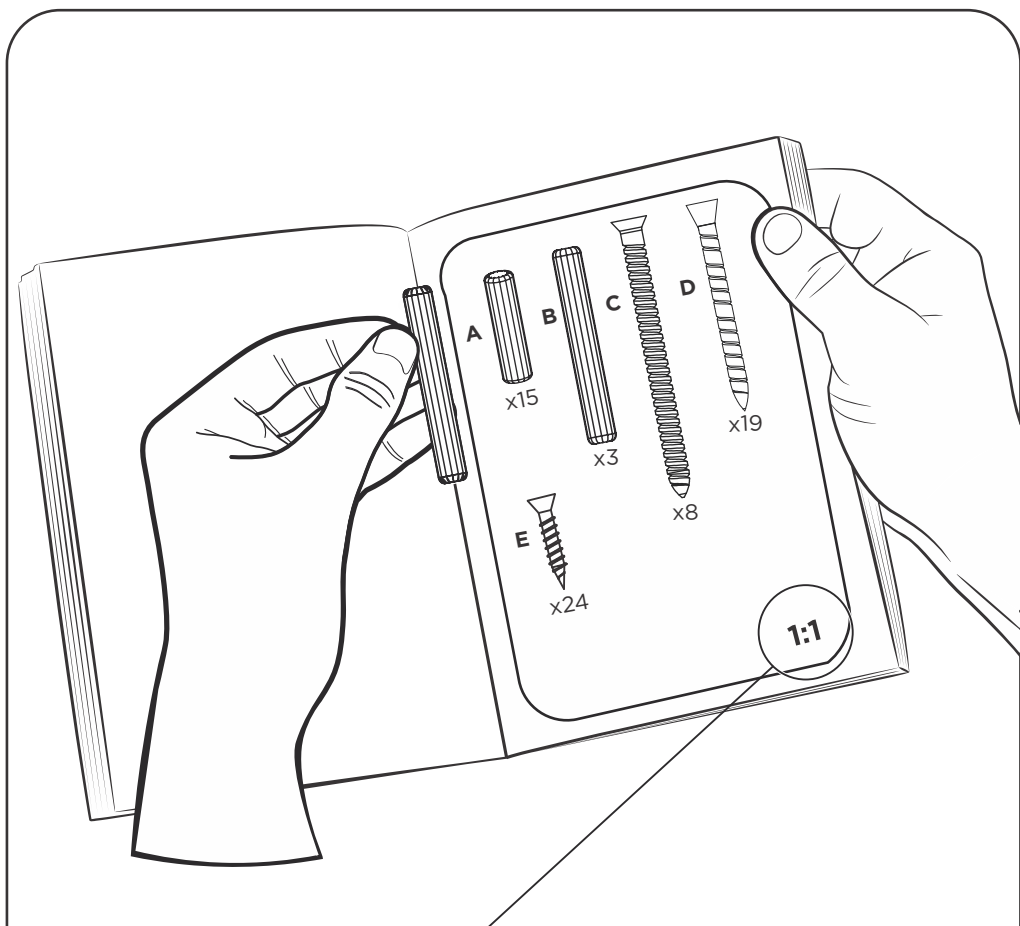



Preste Atenção!

As ferragens dos nossos manuais são sempre apresentadas nas mesmas proporções da peça na vida real. Caso apareça alguma dúvida no decorrer do processo de montagem, coloque a ferragem ao lado do desenho e faça a consulta :D



Símbolos:

-  Parafuso Phillips
-  Parafuso Fenda
-  Parafuso Allen

A

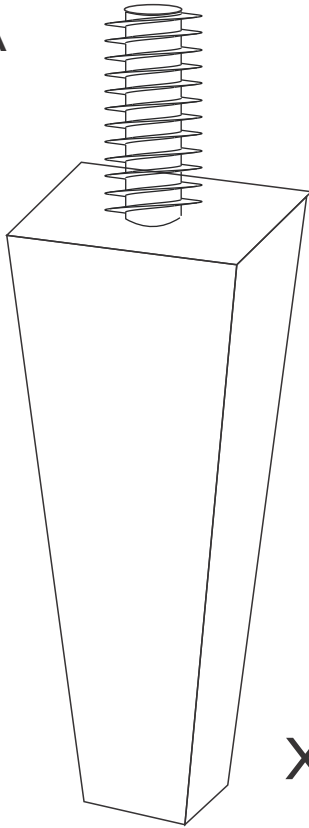

x4

LISTA DE PEÇAS

Nº PEÇA	CÓD. FORNEC.	DESCRIÇÃO	QTD	DIMENSÕES (mm)			PESO UNT (KG)
				COMP.	LARG.	ESP.	
1		Sofá	1				
2		Pés de Madeira Maciça	4	12	5	5	0,3

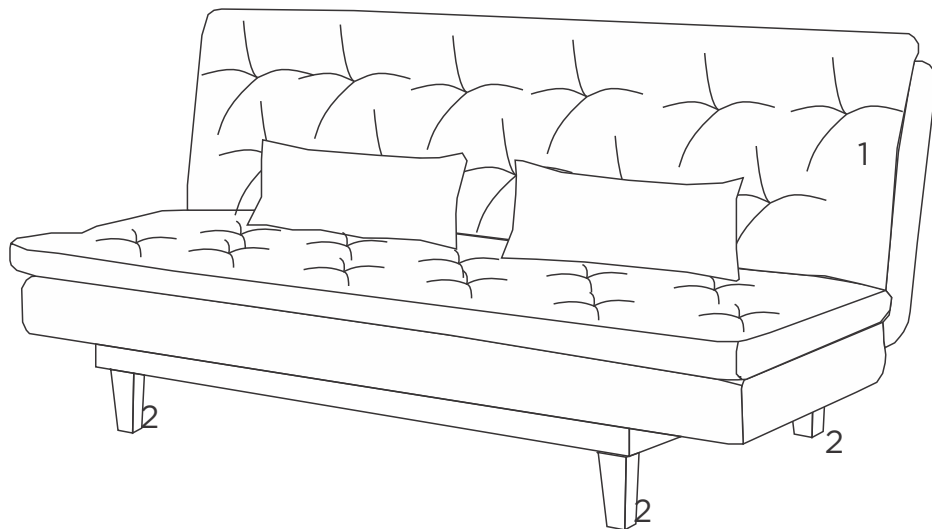

1

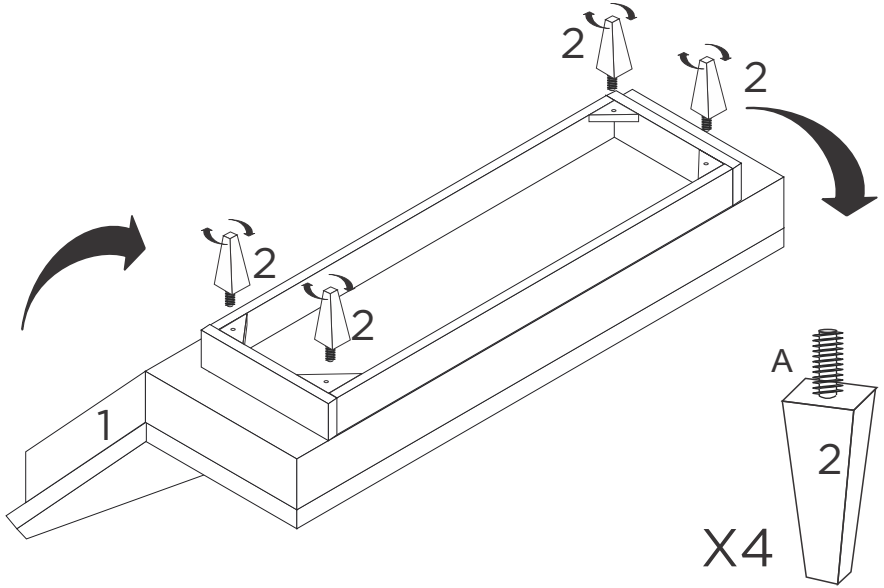

2

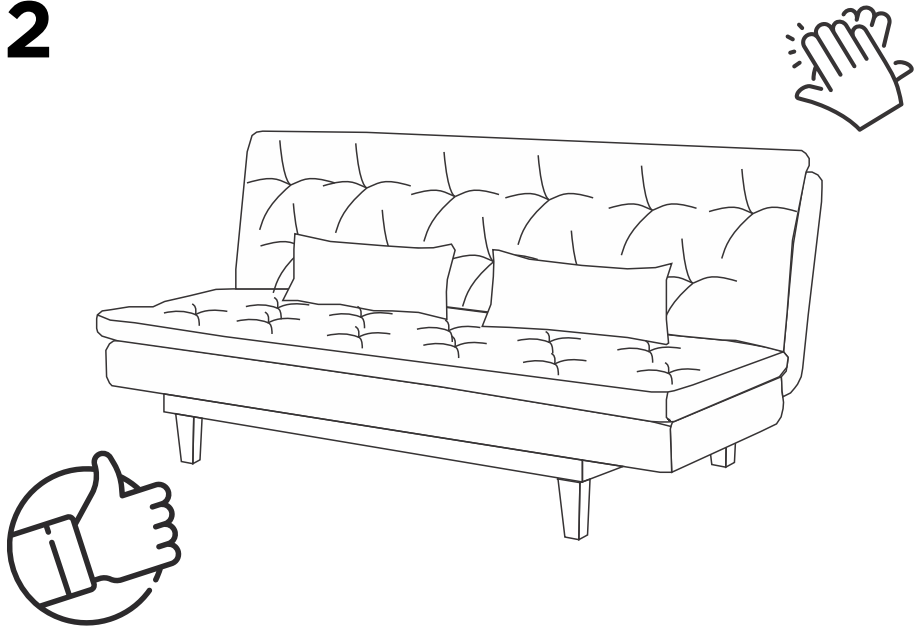



yes casa