

Peroba

Móveis Infantis

MANUAL DE INSTRUÇÕES

ARMÁRIO JUNIOR/ULI/BOLINHA/TEDY/LUNA 3PT NEW

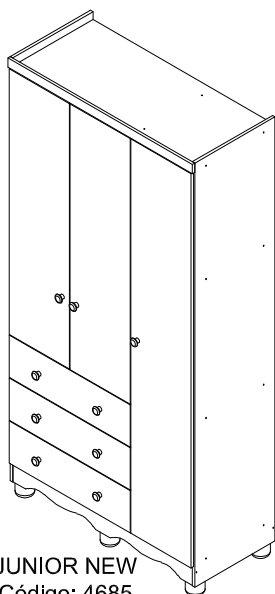

JUNIOR NEW
Código: 4685

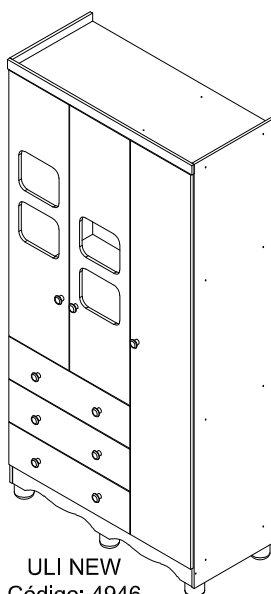

ULI NEW
Código: 4946

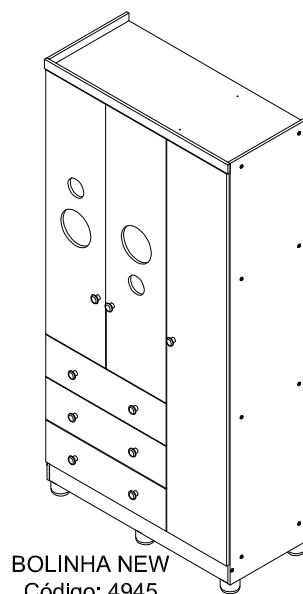

BOLINHA NEW
Código: 4945

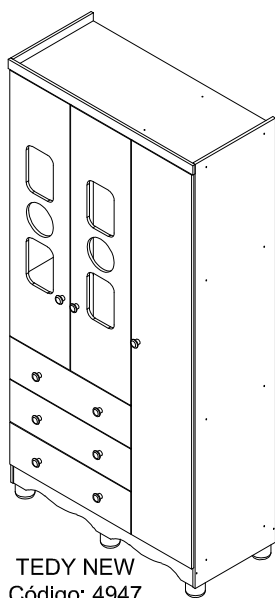

TEDY NEW
Código: 4947

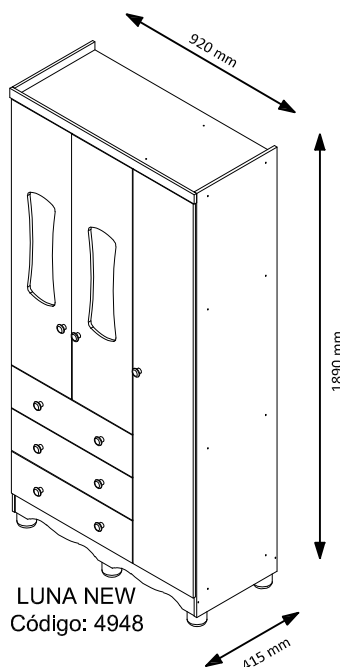

LUNA NEW
Código: 4948

INDÚSTRIA DE MÓVEIS PEROBA LTDA - CNPJ: 06.368.547/0001-20
Avenida dos Moveleiros, 1895, Bairro Canivete, Linhares-ES, CEP: 29.909-120
Tel: (27) 3264-7901 / Cel: (27) 9 8151-3173
www.moveisperoba.com.br

Pág. 01

VERSÃO	DESCRIÇÃO:	ELABOR.:	APROV.:	DATA:	CÓD. DOC.:
01	Elaboração do documento	EPM	PHB	16/05/2023	4950

1. TERMO DE GARANTIA

A Indústria de Móveis Peroba Ltda garante a qualidade dos seus produtos quanto a defeitos e vícios de fabricação, conforme a Lei 8.078/90 (CÓDIGO DE DEFESA DO CONSUMIDOR), nos limites aqui estabelecidos:

1º - Este produto possui **03 (três) meses de garantia legal**. Esse prazo inicia-se na data de entrega do produto.

2º - Entende-se por garantia o reparo gratuito do item comprado, que apresente defeito ou vício de fabricação, de acordo com parecer técnico da Indústria de Móveis Peroba Ltda. Essa garantia somente terá validade mediante a apresentação de uma prova de compra válida.

3º - Para o exercício da presente garantia, o consumidor deverá solicitá-la à loja onde adquiriu o produto, para que a mesma solicite o reparo junto ao fabricante.

4º - Caso seja necessário reparo do produto adquirido, o prazo para devolução do produto, peça ou acessório consertado é de **até 30 dias**.

5º - Todos os produtos devem ser conferidos no momento da entrega.

6º - Não estão cobertos por esta garantia (ônus do consumidor):

a) DANOS DECORRENTES DE MONTAGEM/INSTALAÇÃO INADEQUADA, ASSIM COMO O NÃO CUMPRIMENTO DAS ORIENTAÇÕES CONTIDAS NESSE MANUAL.

b) Danos causados por acidentes, tais como quedas, batidas, desabamentos, incêndios, entre outros, após a instalação do produto.

c) Danos provocados por exposição à umidade, luz solar direta, salinidade, ataque de pragas biológicas decorrentes do ambiente de armazenamento/montagem, após a instalação do produto.

d) Danos decorrentes de limpeza e manutenção inadequados.

e) Danos causados pela colocação de objetos que sejam apoiados, encostados, fixados ou se utilizem do produto como base para sustentação.

f) Danos decorrentes do uso inadequado do produto;

g) Serviços de modificação de local após a instalação do produto, modificação de cor, alteração de medidas e estrutura, modificações de modelo;

h) Roubo ou furto.

PREENCHA OS DADOS A SEGUIR:

Data da compra: ____/____/____ Número da Nota Fiscal: _____

Número do lote: _____

Em caso de assistência técnica, entre em contato com a loja onde adquiriu o produto.

Guarde sempre a Nota fiscal e este manual, pois são partes fundamentais para o atendimento da garantia.

2. LIMPEZA E CONSERVAÇÃO

a) Na limpeza de rotina utilize somente um pano limpo e macio, ligeiramente umedecido em água (apenas o bastante para remover a poeira), seguido de um pano seco. Para sujeiras mais difíceis, utilize um pano ligeiramente umedecido com um pouco de sabão neutro, também seguido de um pano seco e macio.

a.1) Nunca utilize:

- Pano encharcado, pois o acúmulo de água causa danos ao móvel;
- Pano de cozinha (louça), pois pode conter resíduos de gordura;
- Material pontiagudo, cortante ou abrasivo, como estiletes, esponjas de aço ou esponjas abrasivas, pois podem arranhar a pintura;
- Lustra móveis colorido ou com cera, porque podem manchar o acabamento do móvel;
- Diluentes, limpadores instantâneos, produtos de limpeza a base de amônia ou saponáceo, porque estes produtos químicos podem danificar o acabamento;

b) Evite a incidência de luz solar direta sobre o móvel, pois isso pode desbotar o acabamento com o tempo.

c) Não exponha o móvel a ambientes com excesso de umidade ou próximo a paredes com bolor ou mofo.

d) Sempre deixe os móveis a uma distância de 3,0 a 5,0 cm de distância das paredes, para permitir a circulação de ar.



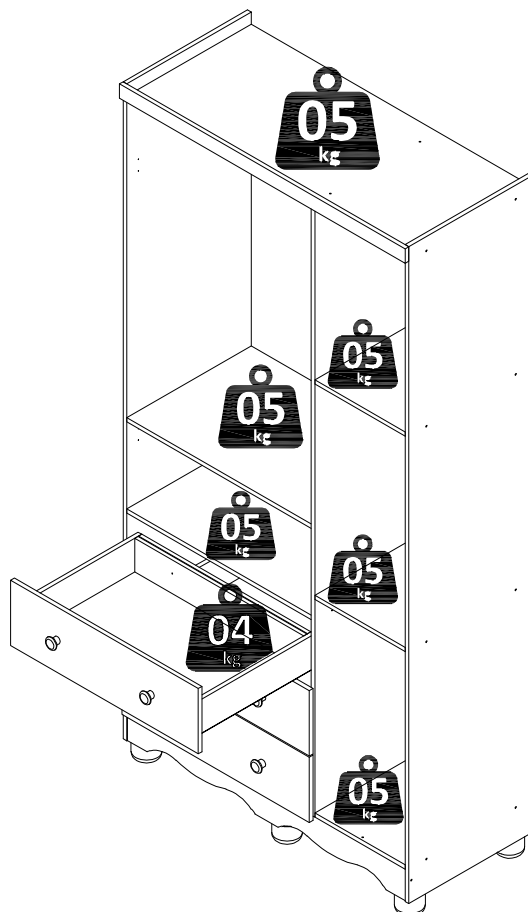



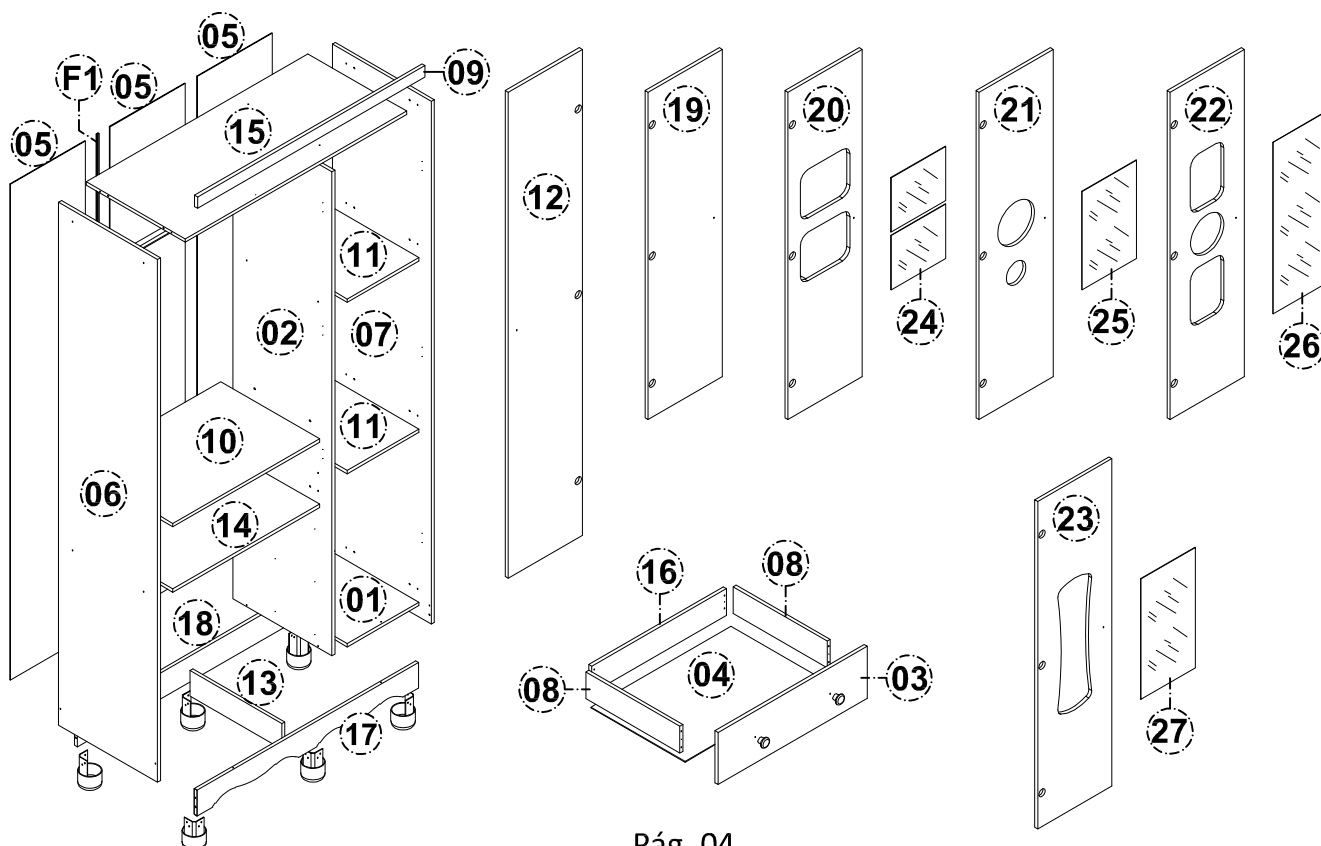

e) Respeite os limites de peso suportados pelo móvel:

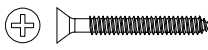
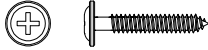

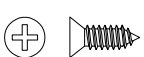
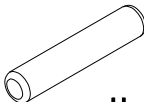
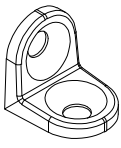
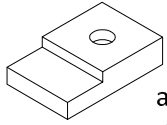
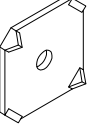
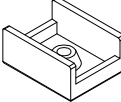
3. IDENTIFICAÇÃO DAS PEÇAS, ACESSÓRIOS E FERRAGENS

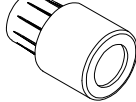
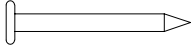
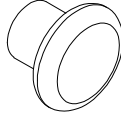
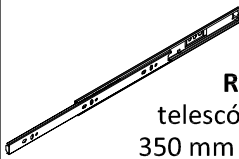
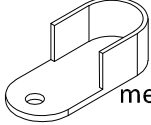
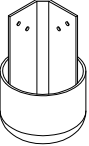
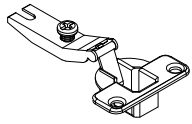
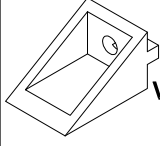
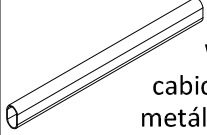
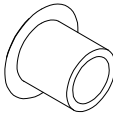
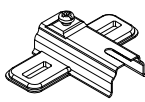
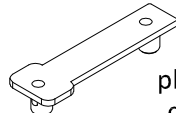
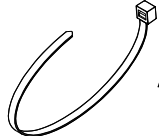
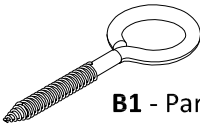
ITEM	DESCRIÇÃO	DIMENSÕES (mm)						CORES	
		COMP	LARG	ESP	MAT	QTD	CÓD	Branco BRI	Carv./Branco BRI
01	Base	400	290	12	MDF	01	4695	Branco/Cru	Branco/Cru
02	Divisão direita	1694	400	12	MDF	01	4701	Branco/Branco	Branco/Branco
03	Frente gaveta	603	182	12	MDF	03	4697	Branco BRI/Branco	Carvalho/Branco
04	Fundo gaveta	572	397	2,5	HDF	03	4700	Branco/Cru	Branco/Cru
05	Fundo traseiro pintado	1735	305	2,5	HDF	03	0024	Branco/Cru	Branco/Cru
06	Lateral direita	1830	400	12	HDF	01	4689	Branco BRI/Branco	Carvalho/Branco
07	Lateral esquerda	1830	400	12	MDF	01	4690	Branco BRI/Branco	Carvalho/Branco
08	Lateral gaveta	380	96	12	MDF	06	4698	Branco/Branco	Branco/Branco
09	Moldura	921	40	15	MDF	01	4691	Branco BRI	Carvalho
10	Prateleira grande móvel	593	400	12	MDF	01	0013	Branco/Branco	Branco/Branco
11	Prateleira pequena fixa	400	290	12	MDF	02	4696	Branco/Branco	Branco/Branco
12	Porta grande	1701	300	12	MDF	01	0023	Branco BRI/Branco	Branco BRI/Branco
13	Sarrafo de rodapé	372	90	12	MDF	01	0021	Cru/Cru	Cru/Cru
14	Tampo do gaveteiro	593	400	12	MDF	01	4693	Branco/Cru	Branco/Cru
15	Tampo superior	895	400	12	MDF	01	4692	Branco/Cru	Branco/Cru
16	Traseiro de gaveta	473	96	12	MDF	03	4699	Branco/Cru	Branco/Cru
17	Rodapé torneado	895	90	12	MDF	01	0008	Branco BRI/Cru	Carvalho/Cru
18	Rodapé reto	895	90	12	MDF	01	0009	Branco BRI/Cru	Carvalho/Cru
Modelo Porta									
19	Porta Junior New	1146	300	12	MDF	02	4936	Branco BRI/Branco	Branco BRI/Branco
20	Porta Usinada Uli New	1146	300	12	MDF	02	4638	Branco BRI/Branco	Branco BRI/Branco
21	Porta Usinada Bolinha New	1146	300	12	MDF	02	4937	Branco BRI/Branco	Branco BRI/Branco
22	Porta Usinada Tedy New	1146	300	12	MDF	02	4939	Branco BRI/Branco	Branco BRI/Branco
23	Porta Usinada Luna New	1146	300	12	MDF	02	4940	Branco BRI/Branco	Branco BRI/Branco
Modelo Porta Janela									
24	Acrílico Uli New	220	190	1,5	PETG	04	0102	Cristal	Cristal
25	Acrílico Bolinha New	325	176	1,5	PETG	02	0100	Cristal	Cristal
26	Acrílico Tedy New	656	159	1,5	PETG	02	0103	Cristal	Cristal
27	Acrílico Luna New	482	155	1,5	PETG	02	0117	Cristal	Cristal

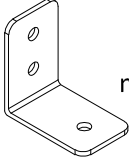

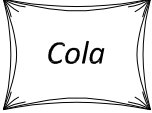
 <p>B - Parafuso chato estrutural philips 5x40 s/ ponta (cód. 2232) 28un</p>	 <p>C - Parafuso chato philips 3,5x35 c/ ponta (cód. 2235) 06un</p>	 <p>E - Parafuso flangeado philips 3,5x30 c/ ponta (cód. 2237) 09un</p>	 <p>F - Parafuso flangeado philips 3,5x12 c/ ponta (cód. 2270) 43un</p>
 <p>G - Parafuso chato philips 3,5x10 c/ ponta (cód. 2233) 104un</p>	 <p>H - Cavilha madeira 6x30 mm (cód. 2225) 30un</p>	 <p>I - Cantoneira metálica com furos 13x13 mm (cód. 3105) 10un</p>	 <p>J - Suporte plástico p/ acrílico 16x12x03 mm (cód. 2244) 16un</p>
 <p>K - Fixa fundo metálico 12x12 mm (cód. 2228) 18un</p>	 <p>L - Sapata plástica "U" 12X12 mm (cód. 2292 BR 2293 CAR) 10un</p>	 <p>M - Tampa furo adesivo 15 mm branco (cód. 2341) 16un</p>	 <p>O - Suporte plástico p/ prateleira 15x10 mm (cód. 2245) 04un</p>
 <p>P - Pregos 10x10 (cód. 2241) 130un</p>	 <p>Q - Puxador plástico bolinha 25x35 mm (cód. 65 BR 66 CAR) 09un</p>	 <p>R - Corrediça telescópica 02 est. 350 mm (cód. 1507) 03 Pares</p>	 <p>S - Suporte de cabideiro oblongo metal 45 x20 x10mm (cód. 2243) 02un</p>
 <p>T - Pé plástico redondo cantoneira 60 x 70 x 70 mm (cód. 67) 06un</p>	 <p>U - Dobradiça metálica caneco 26 mm (cód. 2227) 09un</p>	 <p>V - Suporte angular plástico 45x20x20 (cód. 2486) 04un</p>	 <p>W - Tubo cabideiro oblongo metálico 585x25x16 (cód. 69) 01un</p>
 <p>X - Tampa furo 05 mm (cód. 2247 BR 2295 CAR) 06un</p>	 <p>Y - Calço metálico 05 mm alt. p/ dobradiça 26 mm (cód. 2257) 09un</p>	 <p>Z - Bucha plástica dupla p/ calço dobradiça 42x13 (cód. 2258) 09un</p>	 <p>A1 - Abraçadeira nylon 200 mm (cód. 2223) 01un</p>
 <p>B1 - Parafuso pitão 4,2x55 mm (cód. 2240) 01un</p>	 <p>C1 - Bucha plástica expansiva 06 mm (cód. 2224) 01un</p>	 <p>D1 - Cantoneira metálica 03 furos 30x18 mm (cód. 2291) 01un</p>	 <p>E1 - Parafuso panela philips 4x12 s/ ponta (cód. 2259) 18un</p>
 <p>F1 - Perfil plástico p/ união de fundos 1735x15x5mm (cód. 70 BR) 01un</p>	 <p>J - Cola sachet 10g (cód. 2454) 01un</p>		

4. FERRAMENTAS NECESSÁRIAS PARA MONTAGEM



01 Montador
(Não Incluso)

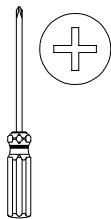

Chave Philips
(Não Incluso)

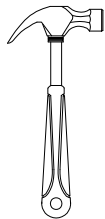

Martelo
(Não Incluso)

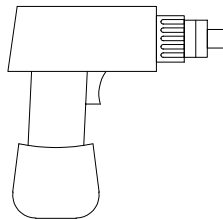

Parafusadeira
(Não Incluso)

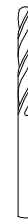

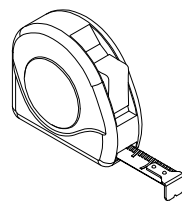

Broca p/ parede 06 mm
(Não Incluso)



Trena
(Não Incluso)

5. MONTAGEM PASSO A PASSO

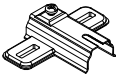
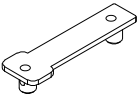
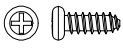
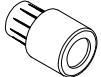
1º - PREPARAÇÃO DAS PEÇAS:

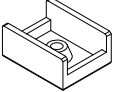
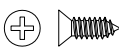
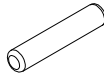
 Y 09 un	 Z 09 un	 E1 18 un	 O 04 un	 R1 06 un	 S 02 un
 L 10 un	 G 32 un	 H 06 un			

*** FORRE O LOCAL DA MONTAGEM COM O PRÓPRIO PAPERÃO DA EMBALAGEM ***

1º - Empurre a trava de segurança para cima

2º - Puxe para fora

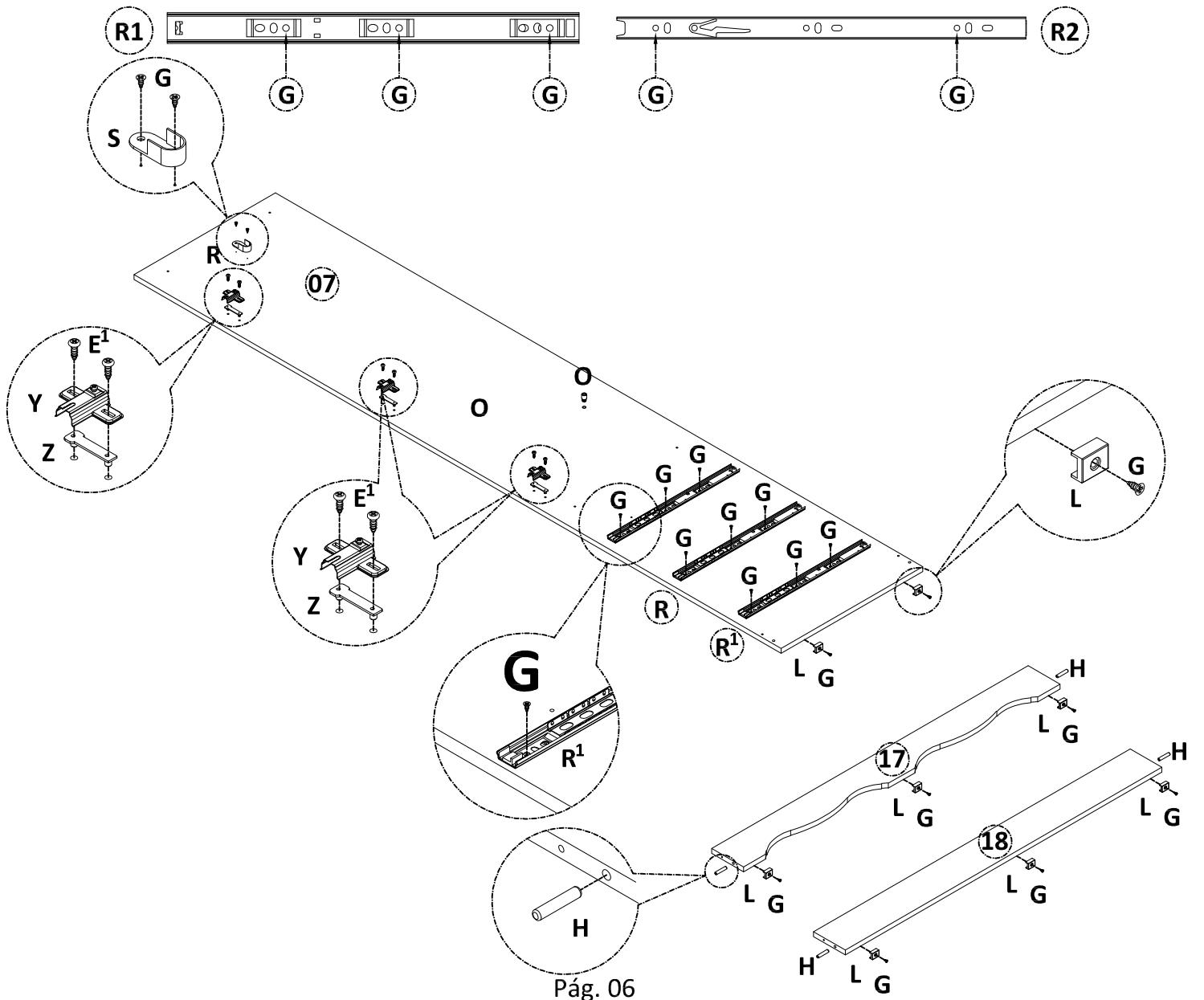
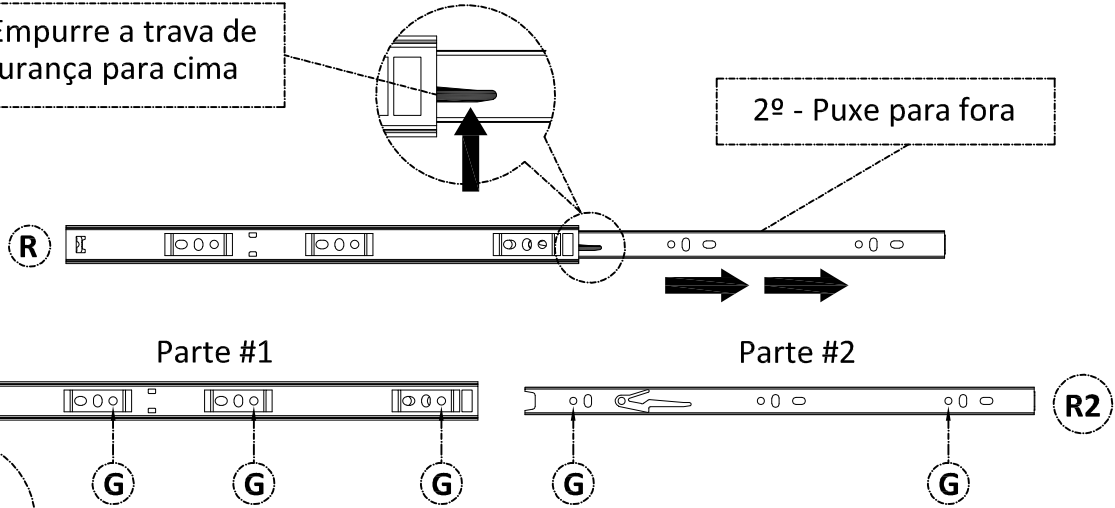

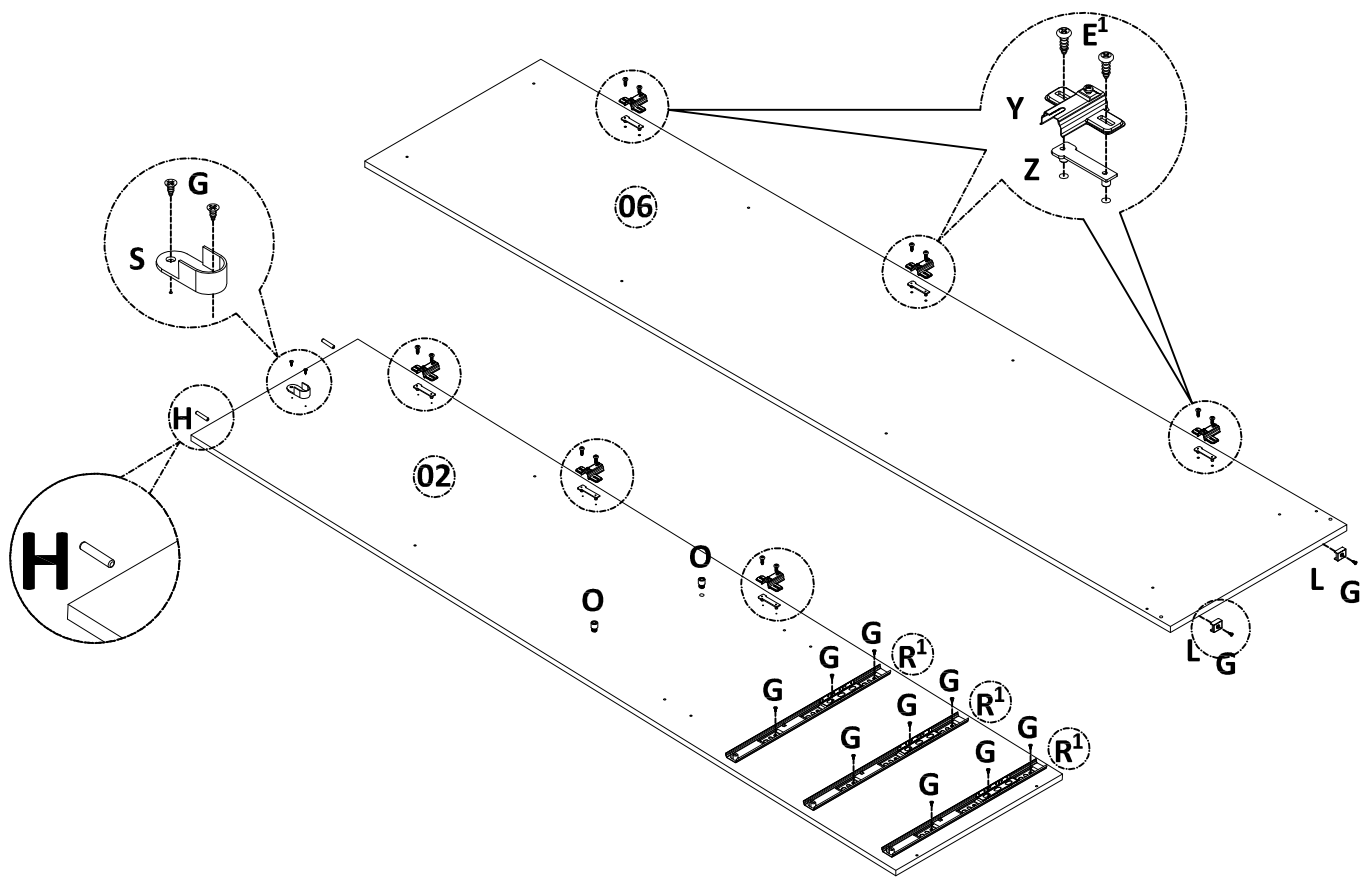



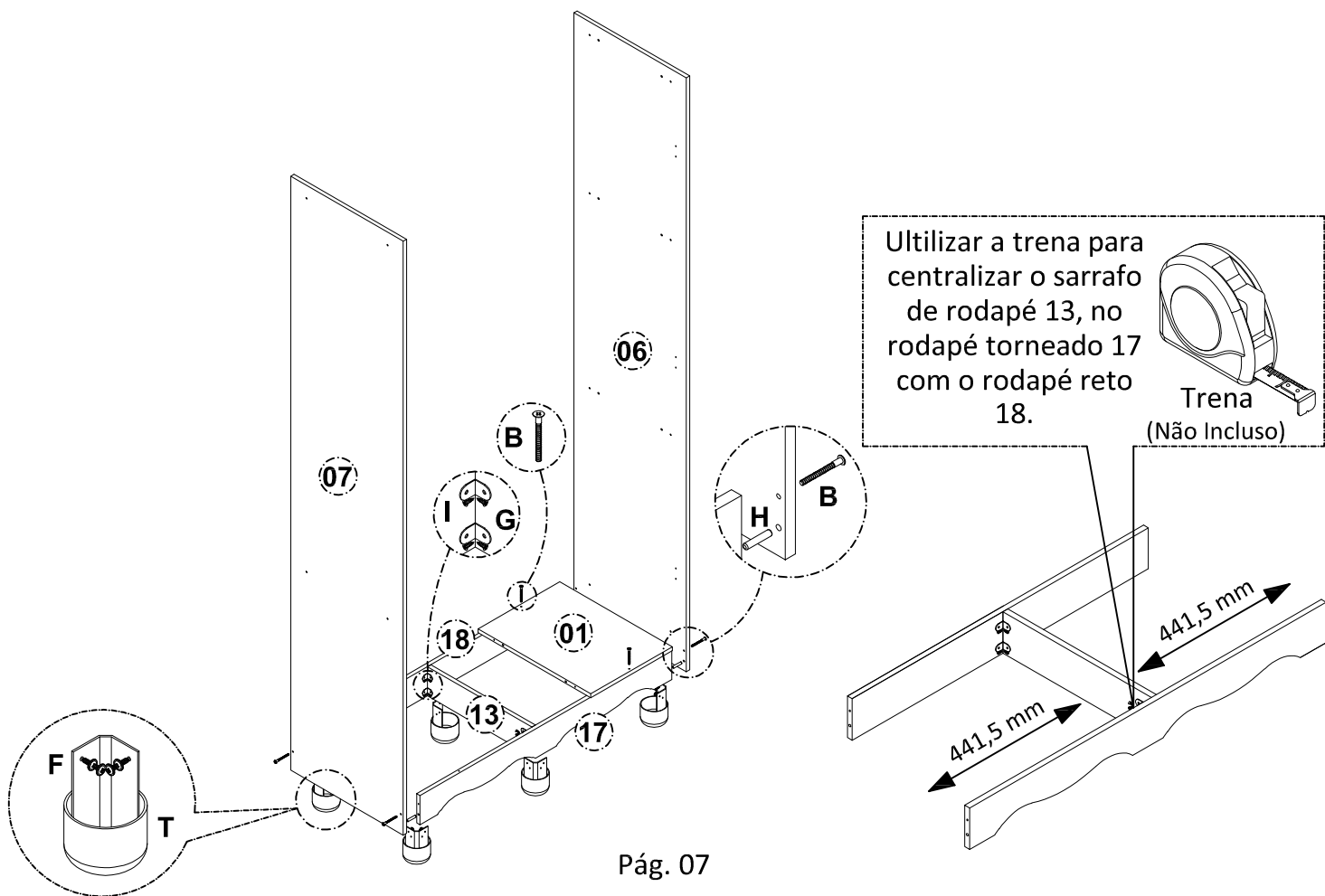
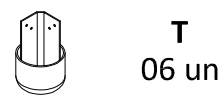
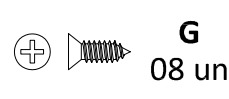
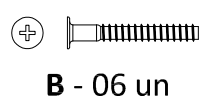

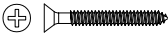

2º - MONTAGEM DA ESTRUTURA:

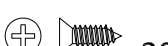
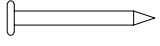
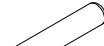

3º - MONTAGEM DAS GAVETAS (3X):

 C - 06 un	 E - 06 un	 G 30 un	 P - 50 un	 H 24 un	 I 06 un
 R2 06 un	 Q 6 un				

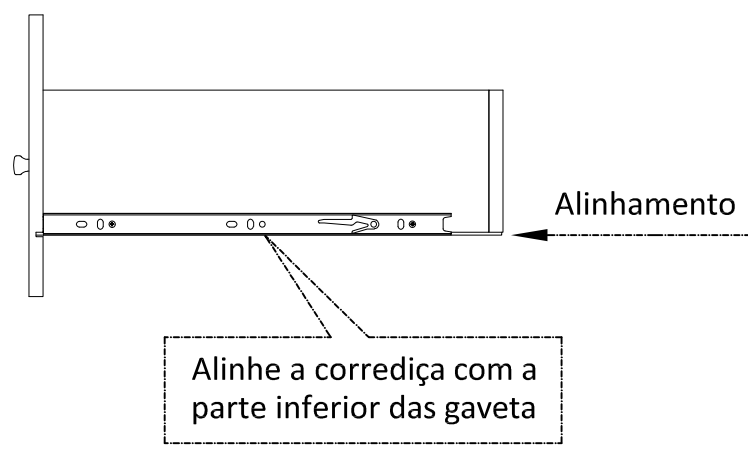
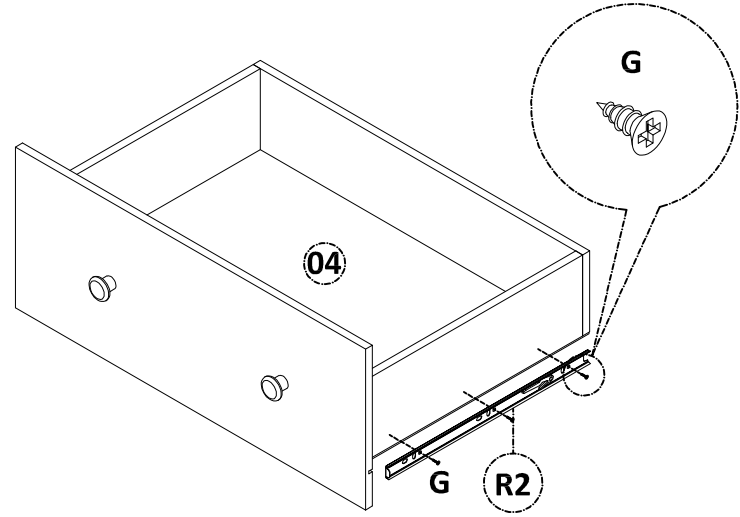
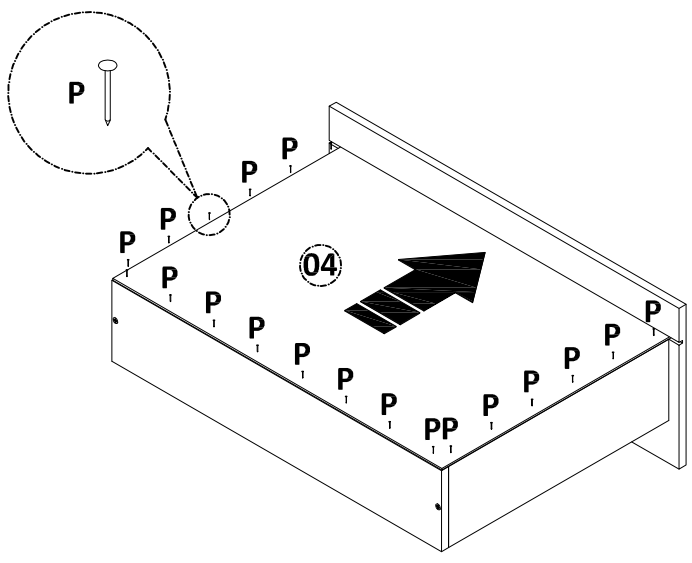
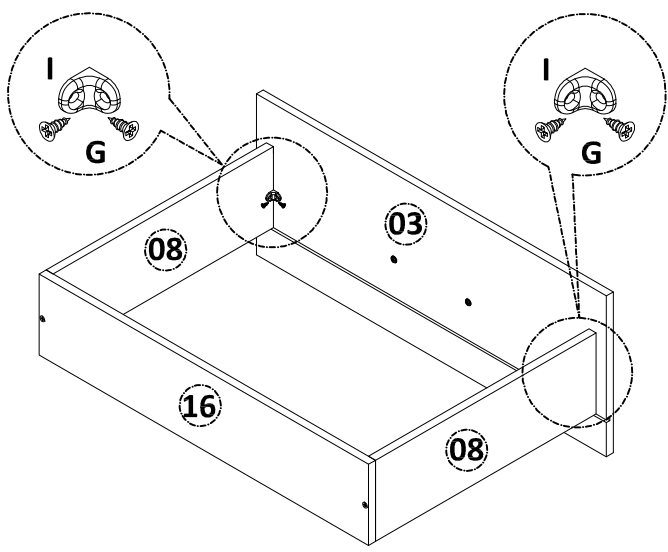
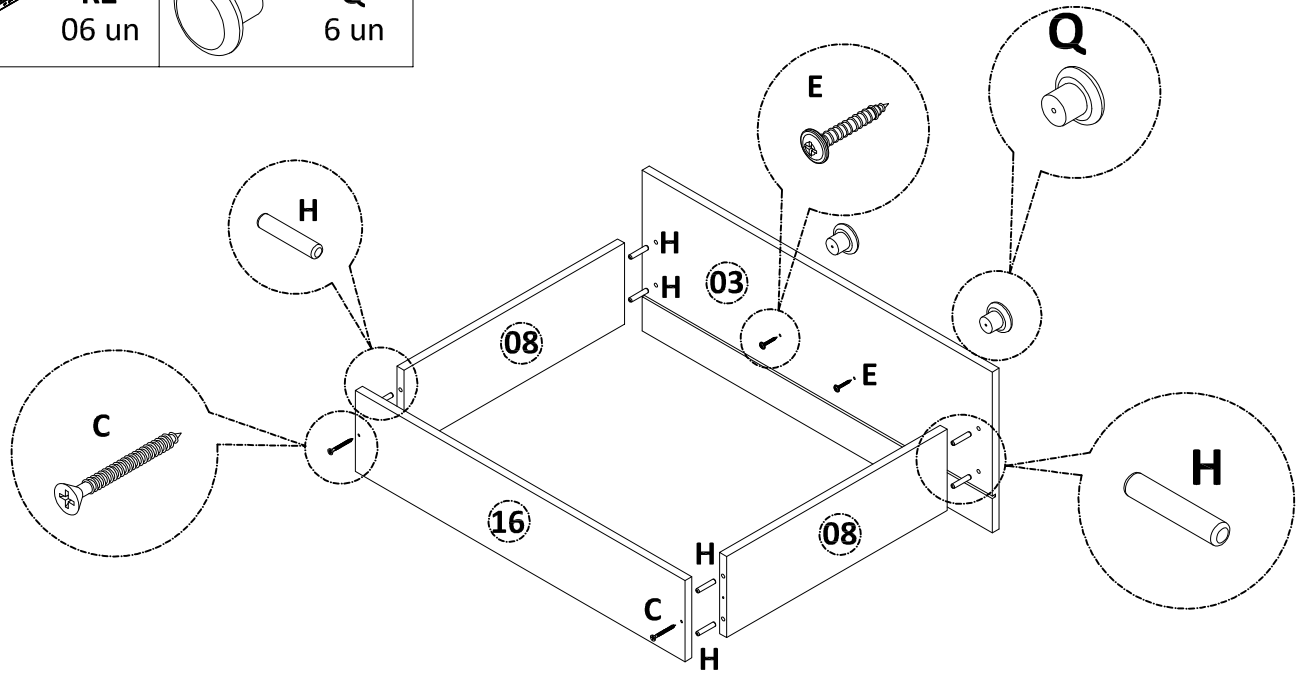

4º - MONTAGEM DA ESTRUTURA

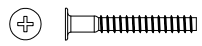

B - 22 un



M
12 un

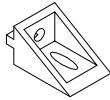

V
04 un



F - 8 un

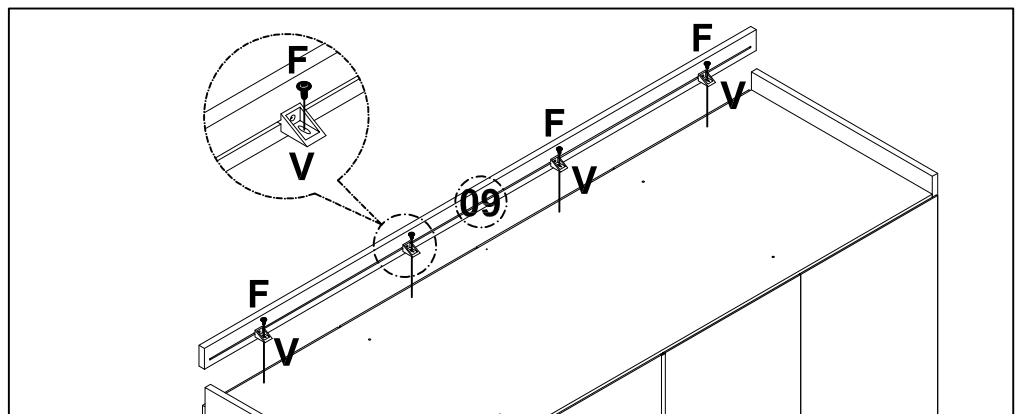
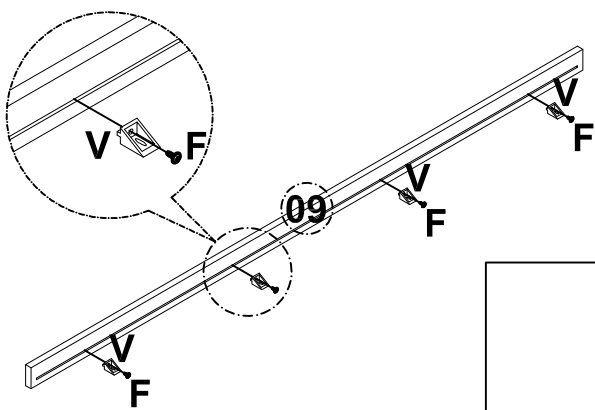
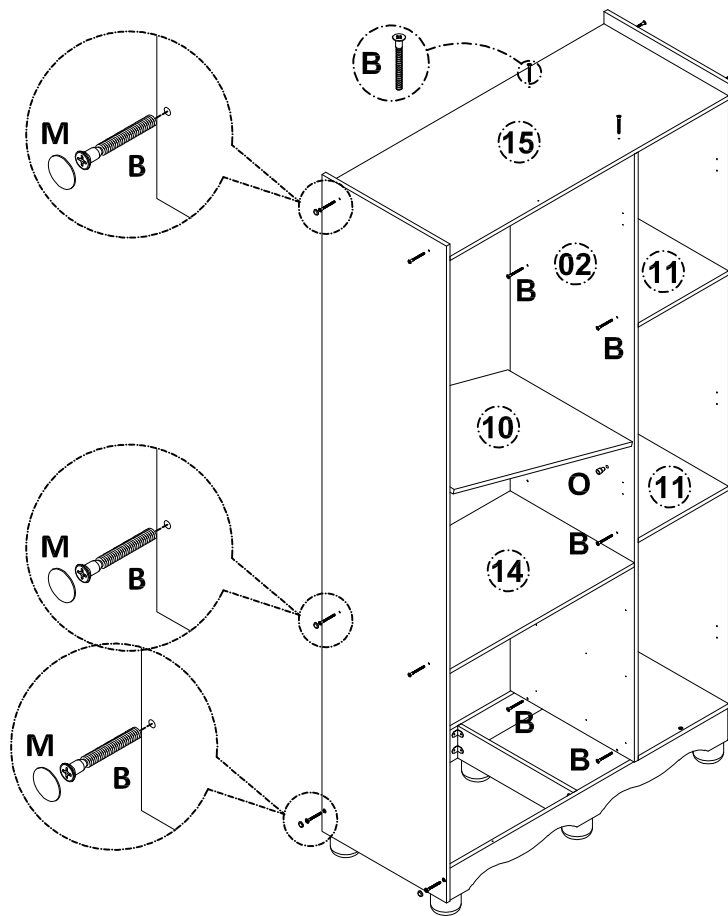

5º - MONTAGEM DAS PORTAS (2X):

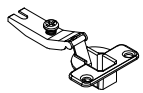

U
09 un

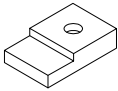

J
12 un

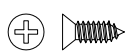

G
30 un

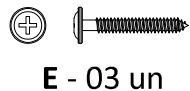

E - 03 un



Q
03 un

Porta pequena usinada
será duas porta

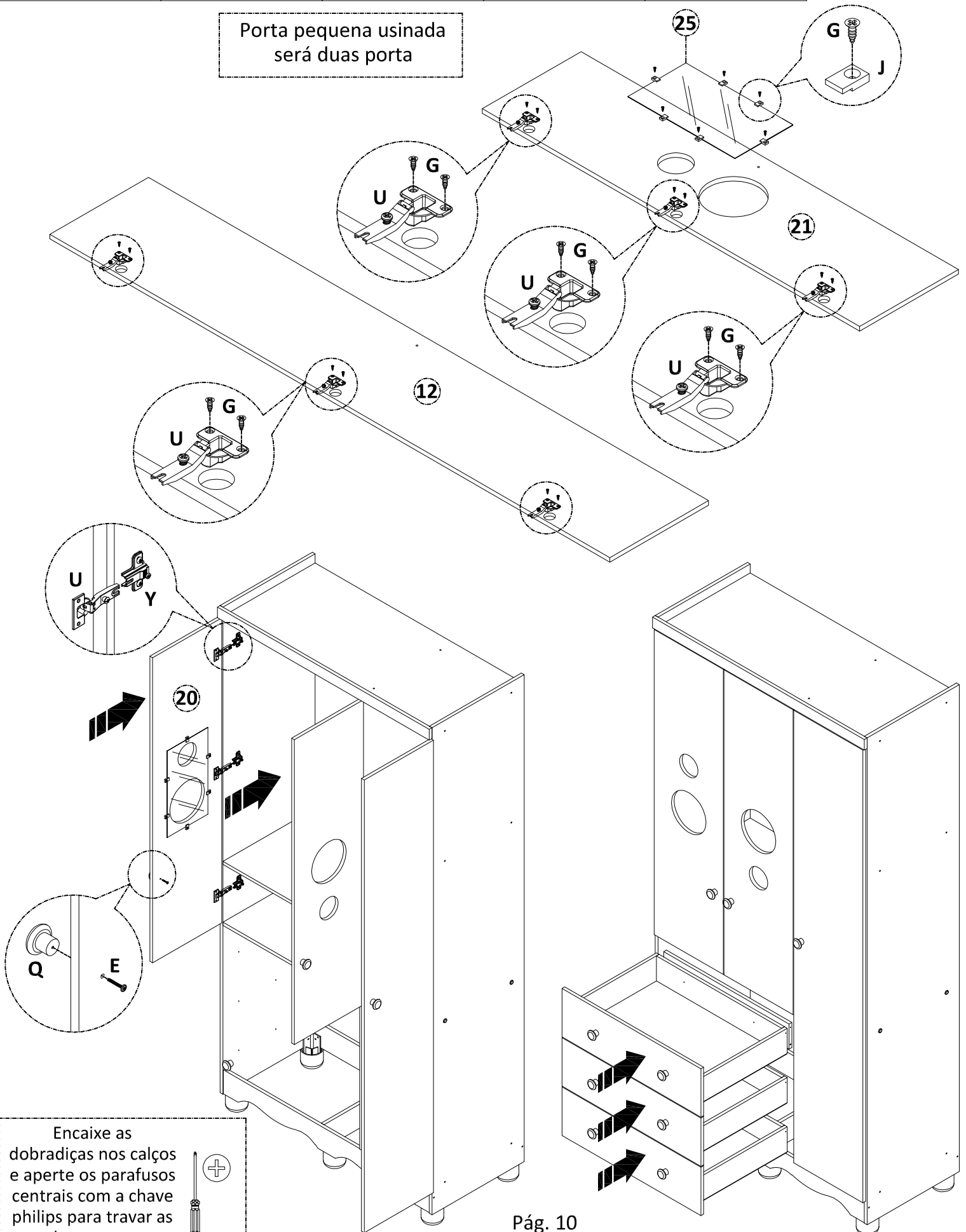

Encaixe as
dobradiças nos calços
e aperte os parafusos
centrais com a chave
philips para travar as
duas partes

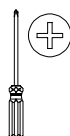

6º - FIXAÇÃO DOS FUNDOS TRASEIROS:



P - 90 un



K
18 un

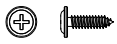

F - 9 un



F1
01 un

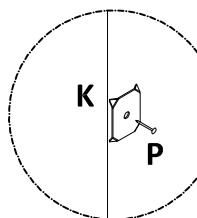
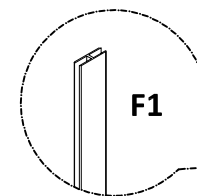

Nas junções dos fundos utilize pregos com fixadores de fundos

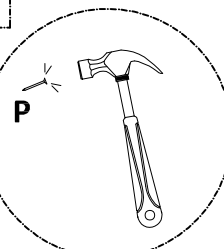
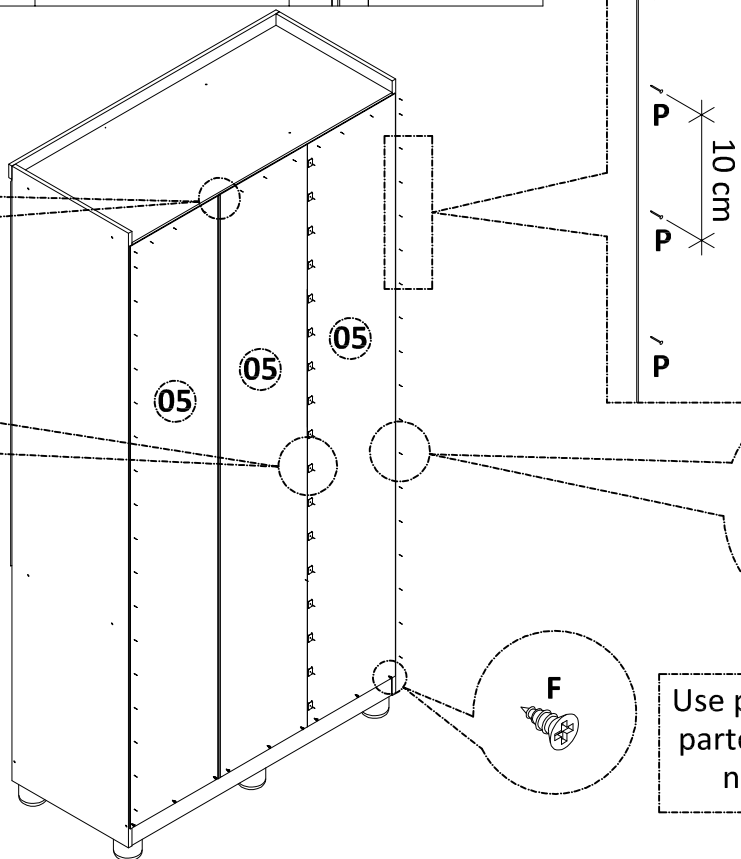

Use parafusos para fixar a parte inferior dos fundos no rodapé traseiro

7º - MONTAGEM DO SISTEMA ANTITOMBAMENTO:

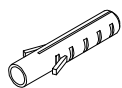

C1
01 un



B1
01 un



D1
01 un



F - 2 un



A1
01 un

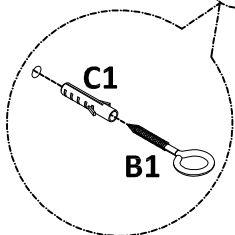

Fure a parede com a broca p/ parede de 06 mm

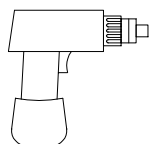

1845 mm

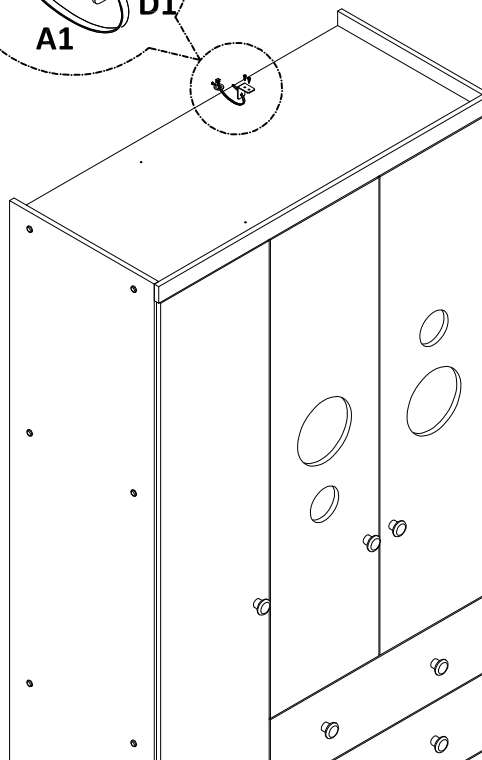
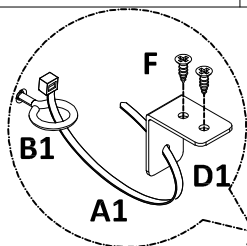

MANUAL DE INSTRUÇÕES

CÔMODAS JUNIOR NEW SIMPLES

Código: 5161



INDÚSTRIA DE MÓVEIS PEROBA LTDA - CNPJ: 06.368.547/0001-20
Avenida dos Moveleiros, 1895, Bairro Canivete, Linhares-ES, CEP: 29.909-120
Tel: (27) 3264-7901 / Cel: (27) 9 8151-3173
www.moveisperoba.com.br

VERSÃO	DESCRIÇÃO:	ELABOR.:	APROV.:	DATA:	CÓD. DOC.:
01	Elaboração do documento	EPM	PHB	01/06/2023	5201

1. TERMO DE GARANTIA

A Indústria de Móveis Peroba Ltda garante a qualidade de seus produtos quanto à defeitos e vícios de fabricação, conforme a Lei 8.078/90 (CÓDIGO DE DEFESA DO CONSUMIDOR), nos limites aqui estabelecidos:

1º - Este produto possui **03 (três) meses de garantia legal**. Esse prazo inicia-se na data de entrega do produto.

2º - Entende-se por garantia o reparo gratuito do item comprado, que apresente defeito ou vício de fabricação, de acordo com parecer técnico da Indústria de Móveis Peroba Ltda. Essa garantia somente terá validade mediante a apresentação de uma prova de compra válida.

3º - Para o exercício da presente garantia, o consumidor deverá solicitá-la à loja onde adquiriu o produto, para que a mesma solicite o reparo junto ao fabricante.

4º - Caso seja necessário reparo do produto adquirido, o prazo para devolução do produto, peça ou acessório consertado é de **até 30 dias**.

5º - Todos os produtos devem ser conferidos no momento da entrega.

6º - Não estão cobertos por esta garantia (ônus do consumidor):

a) DANOS DECORRENTES DE MONTAGEM/INSTALAÇÃO INADEQUADA, ASSIM COMO O NÃO CUMPRIMENTO DAS ORIENTAÇÕES CONTIDAS NESSE MANUAL.

b) Danos causados por acidentes, tais como quedas, batidas, desabamentos, incêndios, entre outros, após a instalação do produto.

c) Danos provocados por exposição à umidade, luz solar direta, salinidade, ataque de pragas biológicas decorrentes do ambiente de armazenamento/montagem, após a instalação do produto.

d) Danos decorrentes de limpeza e manutenção inadequados.

e) Danos causados pela colocação de objetos que sejam apoiados, encostados, fixados ou se utilizem do produto como base para sustentação.

f) Danos decorrentes do uso inadequado do produto;

g) Serviços de modificação de local após a instalação do produto, modificação de cor, alteração de medidas e estrutura, modificações de modelo;

h) Roubo ou furto.

PREENCHA OS DADOS A SEGUIR:

Data da compra: ____/____/____ Número da Nota Fiscal: _____ Número do lote: _____

No caso de assistência técnica, entrar em contato com a loja onde adquiriu o produto.

Guarde sempre a Nota fiscal e este manual, pois são partes fundamentais para o atendimento da garantia.

2. LIMPEZA E CONSERVAÇÃO

a) Na limpeza de rotina utilize somente um pano limpo e macio, ligeiramente umedecido em água (apenas o bastante para remover a poeira), seguido de um pano seco. Para sujeiras mais difíceis, utilize um pano ligeiramente umedecido com um pouco de sabão neutro, também seguido de um pano seco e macio.

a.1) Nunca utilize:

- Pano encharcado, pois o acúmulo de água causa danos ao móvel;
- Pano de cozinha (louça), pois pode conter resíduos de gordura;
- Material pontiagudo, cortante ou abrasivo, como estiletes, esponjas de aço ou esponjas abrasivas, pois podem arranhar a pintura;
- Lustra móveis colorido ou com cera, porque podem manchar o acabamento do móvel;
- Diluentes, limpadores instantâneos, produtos de limpeza a base de amônia ou saponáceo, porque estes produtos químicos podem danificar o acabamento;

b) Evite a incidência de luz solar direta sobre o móvel, pois isso pode desbotar o acabamento com o tempo.

c) Não exponha o móvel a ambientes com excesso de umidade ou próximo a paredes com bolor ou mofo.

d) Sempre deixe os móveis a uma distância de 3,0 a 5,0 cm de distância das paredes, para permitir a circulação de ar.

e) Respeite os limites de peso suportados pelo móvel:

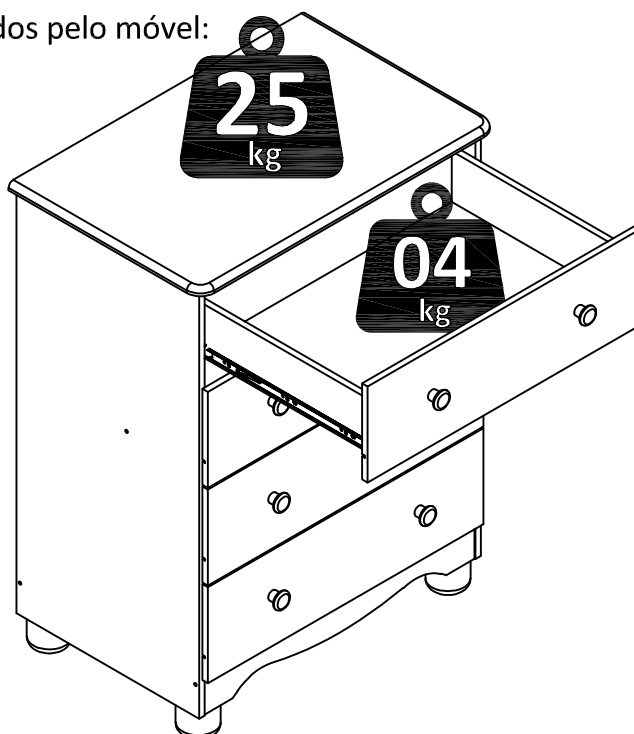





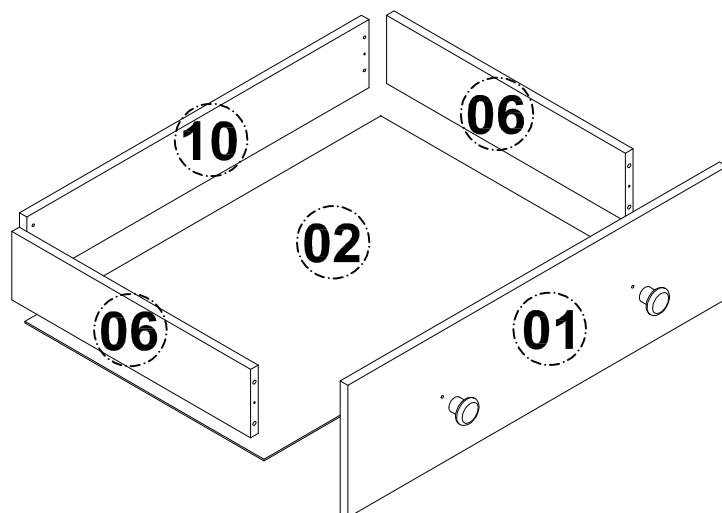
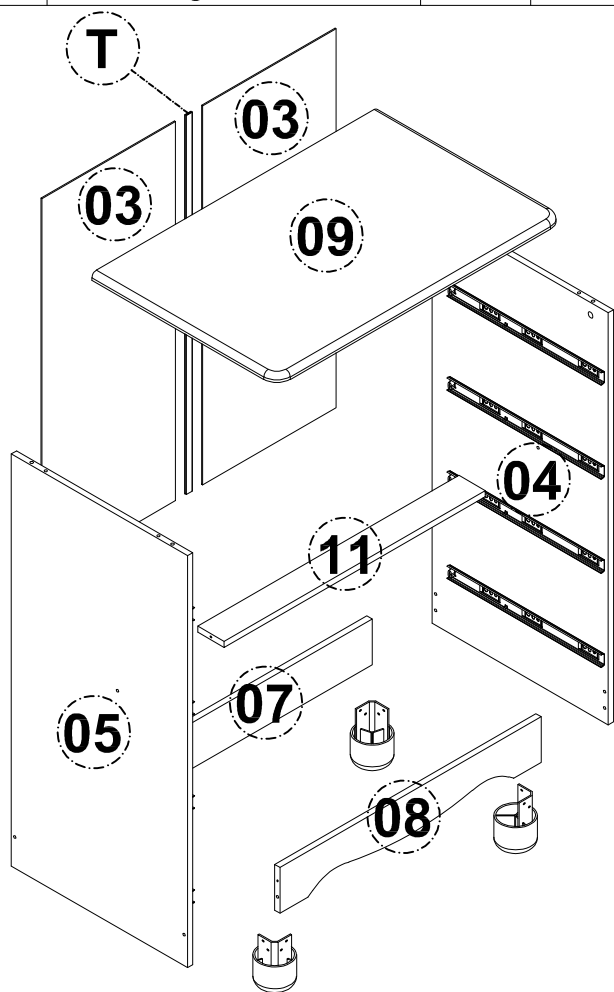

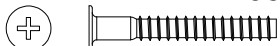
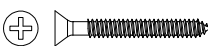

3. IDENTIFICAÇÃO DAS PEÇAS, ACESSÓRIOS E FERRAGENS

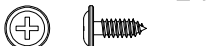
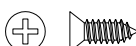
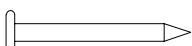
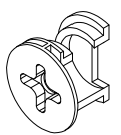
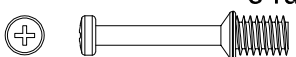
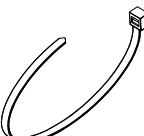
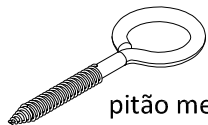
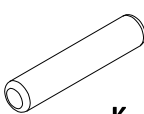
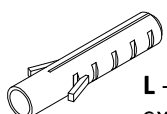
ITEM	DESCRIÇÃO	DIMENSÕES (mm)						CORES	
		COMP	LARG	ESP	MAT	QTD	CÓD	Branco BRI	Branco BRI/Carv.
01	Frente gaveta	602	182	12	MDF	04	4697	Branco BRI	Branco BRI
02	Fundo gaveta	572	397	2,5	MDF	04	4700	Branco	Branco
03	Fundo traseiro sem pintar	745	303	2,5	HDF	02	185	Cru	Cru
04	Lateral direita	810	400	12	MDF	01	5197	Branco BRI	Carvalho
05	Lateral esquerda	810	400	12	MDF	01	5171	Branco BRI	Carvalho
06	Lateral gaveta	380	96	12	MDF	08	4698	Branco	Branco
07	Rodapé reto	593	90	12	MDF	01	183	Branco BRI	Carvalho
08	Rodapé torneado	593	90	12	MDF	01	184	Branco BRI	Carvalho
09	Tampo superior	651	420	15	MDF	01	182	Branco BRI	Carvalho
10	Traseiro de gaveta	573	96	12	MDF	08	4699	Branco	Branco
11	Sarrafo de gaveta	593	60	12	MDF	01	3108	Cru	Cru

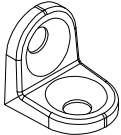
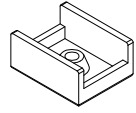

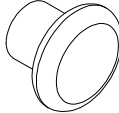
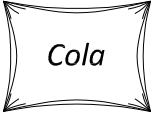

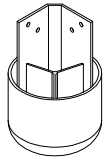

Pág. 04

 <p>A - Parafuso chato estrutural philips 5x40 s/ ponta (cód. 2232)</p>	 <p>B - Parafuso chato philips 3,5x35 c/ ponta (cód. 2235)</p>	 <p>C - Parafuso flangeado philips 3,5x30 c/ ponta (cód. 2237)</p>	 <p>D - Parafuso flangeado philips 3,5x12 c/ ponta (cód. 2270)</p>
 <p>E - Parafuso chato philips 3,5x10 c/ ponta (cód. 2233)</p>	 <p>F - Pregão 10x10 (cód. 2241)</p>	 <p>G - Tambor metálico minifix 12x8,5 mm (cód. 2231)</p>	 <p>H - Haste metálica minifix philips 30 mm (cód. 2229)</p>
 <p>I - Abraçadeira nylon 200 mm (cód. 2223)</p>	 <p>J - Parafuso pitão metálico 4,2x55 mm (cód. 2240)</p>	 <p>K - Cavilha madeira 6x30 mm (cód. 2225)</p>	 <p>L - Bucha plástica expansiva 06 mm (cód. 2224)</p>

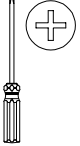
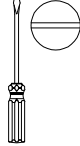

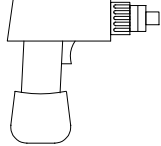

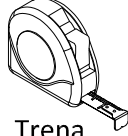
 M - Cantoneira metálica com furos 13x13 mm (cód. 3105) 12un	 N - Sapata plástica "U" 12X12 mm (cód. 2292 BR 2293 CAR) 08un	 O - Tampa furo adesivo 15 mm (cód. 2341 BR 2442 CAR) 06un	 P - Puxador plástico bolinha 30x35 mm (cód. 65 BR 66 CAR) 08un
 Q - Cola sachet 10g (cód. 2454) 01un	 R - Corrediça telescópica 02 est. 350 mm (cód. 1507) 04 Pares	 S - Pé plástico redondo c/ cantoneira 70x70x57 mm (cód. 67 BR 68 CAR) 04un	 T - Perfil plástico p/ união de fundos 724x15x5mm (cód. 186 BR) 01un

4. FERRAMENTAS NECESSÁRIAS PARA MONTAGEM

 01 Montador (Não Incluso)	 Chave Philips (Não Incluso)	 Chave fenda reta (Não Incluso)	 Martelo (Não Incluso)	 Parafusadeira (Não Incluso)	 Broca p/ parede 06 mm (Não Incluso)	 Trena (Não Incluso)
--	--	---	--	---	--	--

5. MONTAGEM PASSO A PASSO





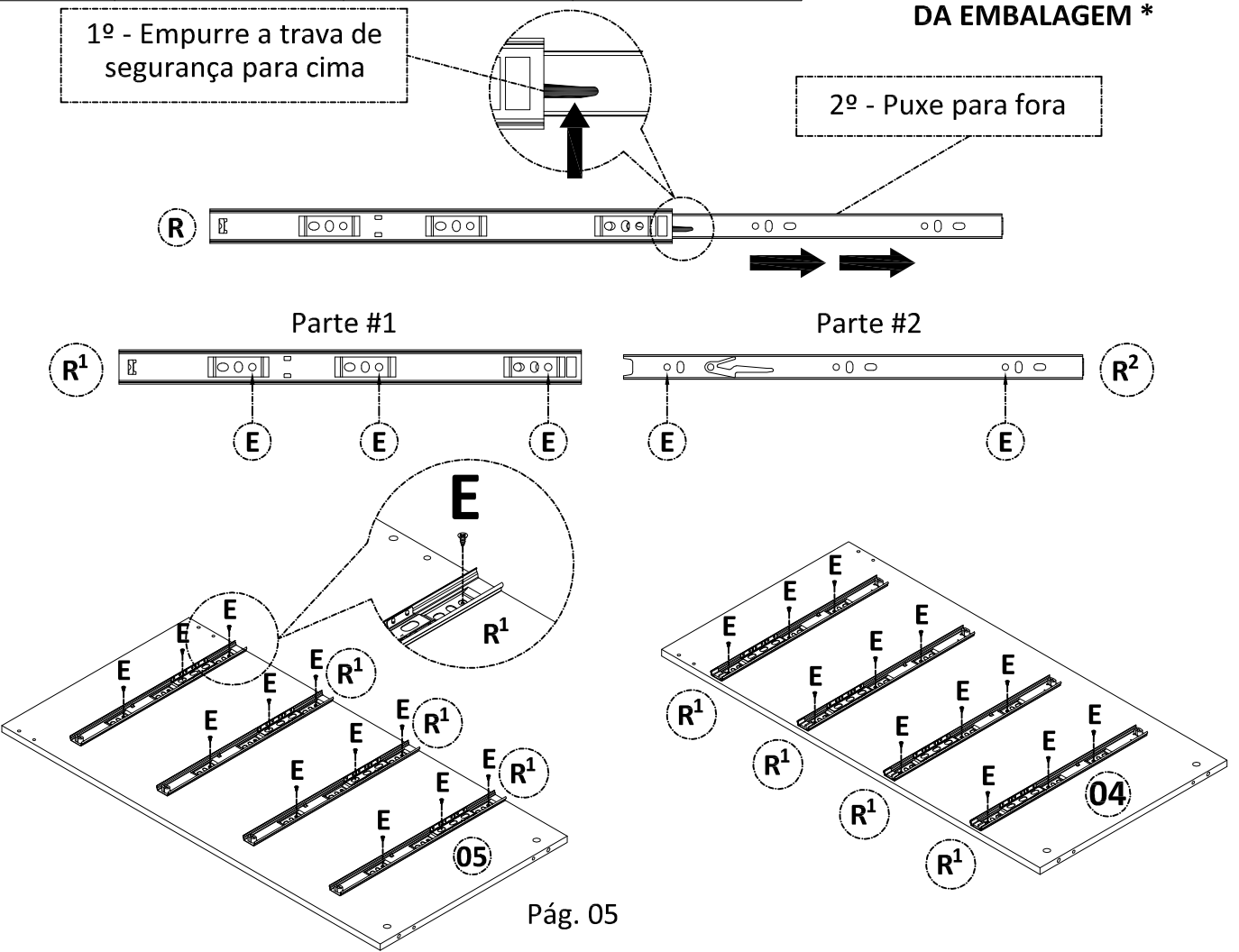

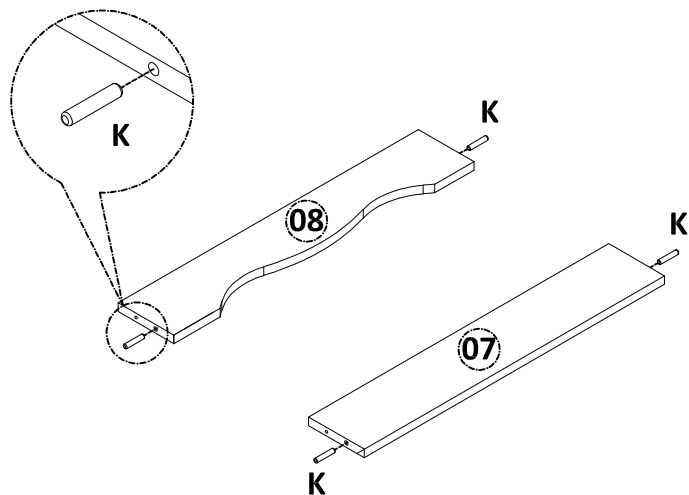
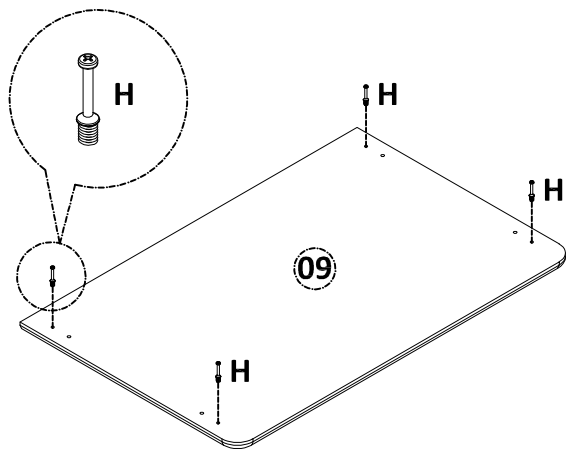
1º - PREPARAÇÃO DAS PEÇAS:

 E 24 un	 K 04 un	 H - 04 un	 R¹ 08 un	* FORRE O LOCAL DA MONTAGEM COM O PRÓPRIO PAPELÃO DA EMBALAGEM *
--	--	--	--	---





2º - MONTAGEM DA ESTRUTURA:

 A - 06 un	 D 16 un	 K 04 un	 G 04 un	 O 06 un	 S 04 un
---	---	---	---	---	---

Essa cômoda possui dois modelos de rodapés inclusos: um reto (peça nº 07) e um torneado (peça nº 08). Escolha um dos modelos e parafuse na parte frontal do produto.

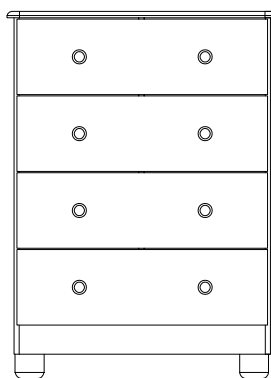
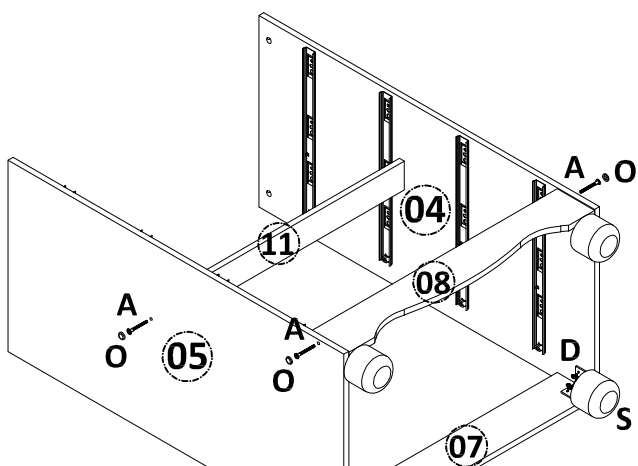



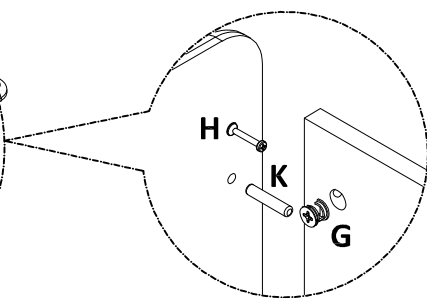
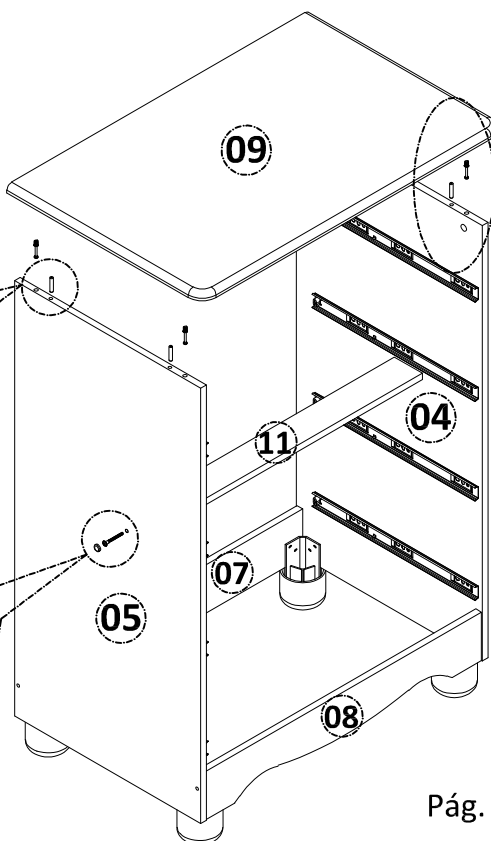
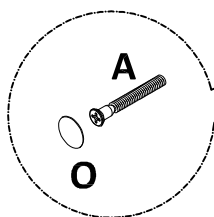
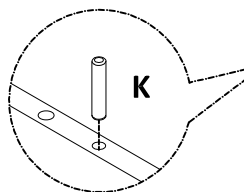
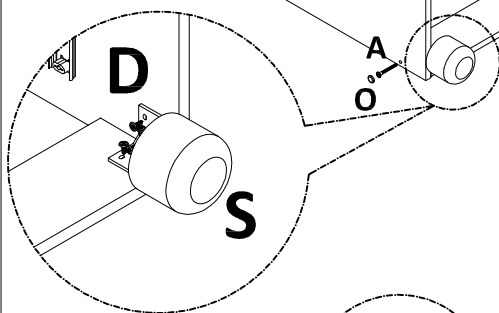
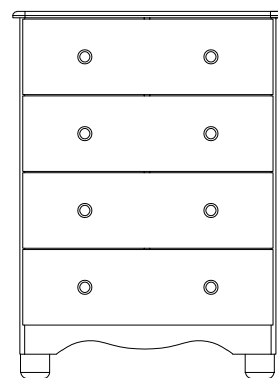

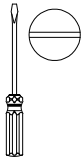



OU



Use a chave de fenda para apertar a travar o tambor de minifix 

3º - MONTAGEM DAS GAVETAS (4X):

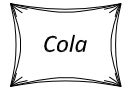
 B - 08 un	 C - 08 un	 E 40 un	 F - 65 un	 K 32 un	 M 08 un
 R² 08 un	 P 8 un	 Cola Q 1 un			

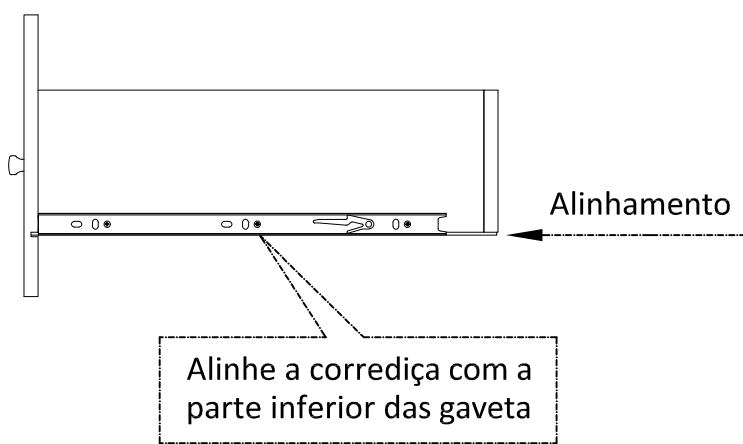
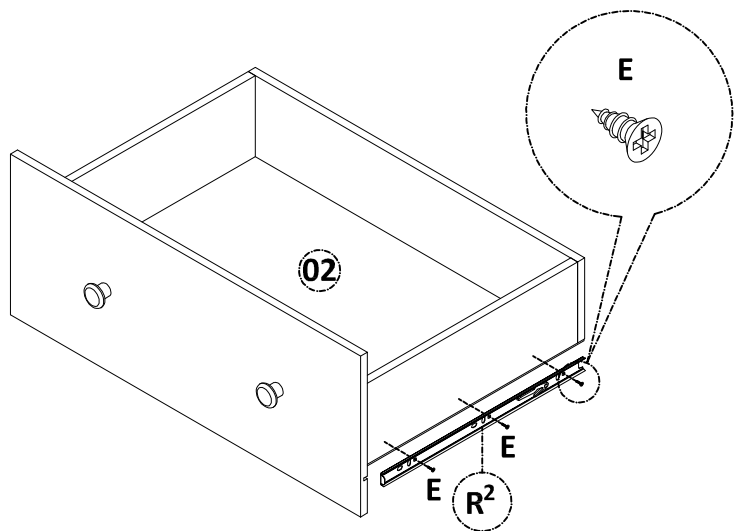
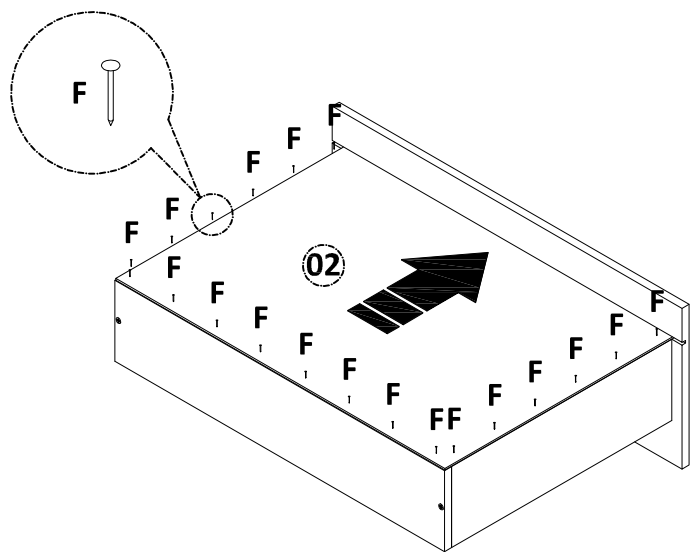
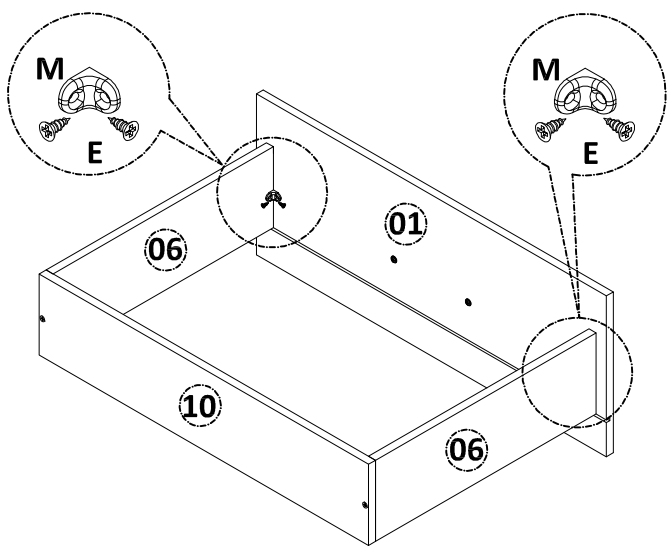
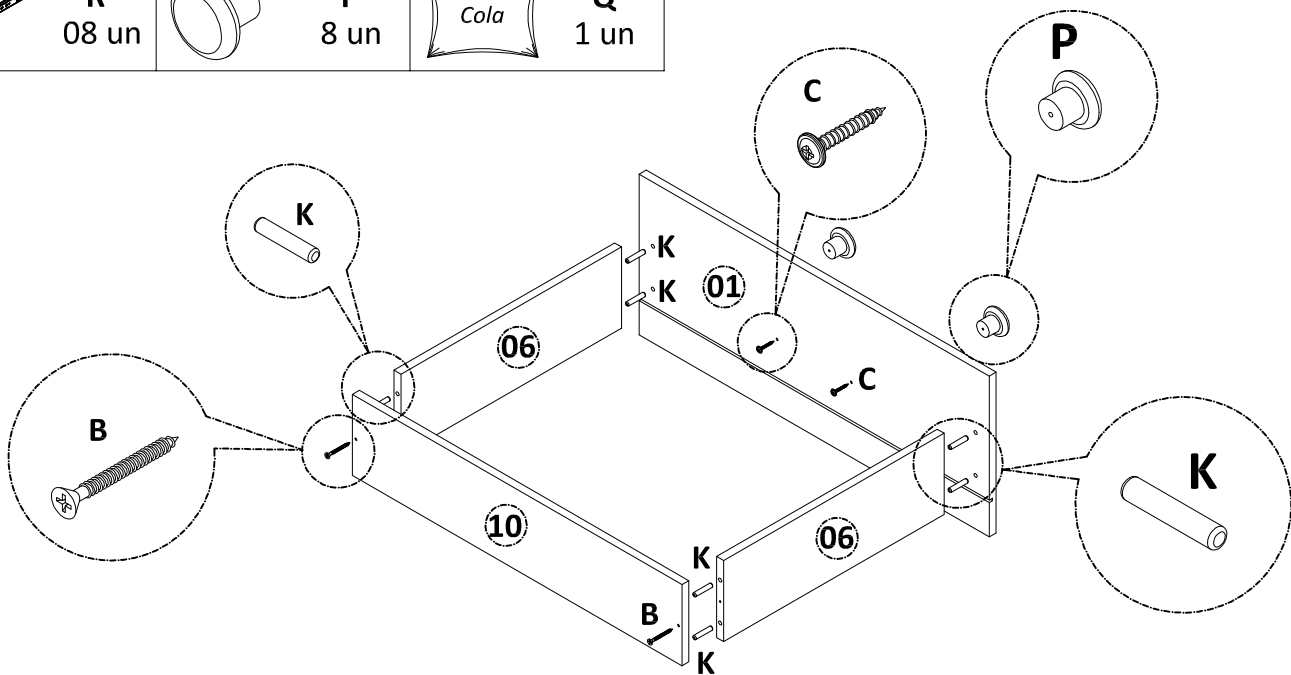

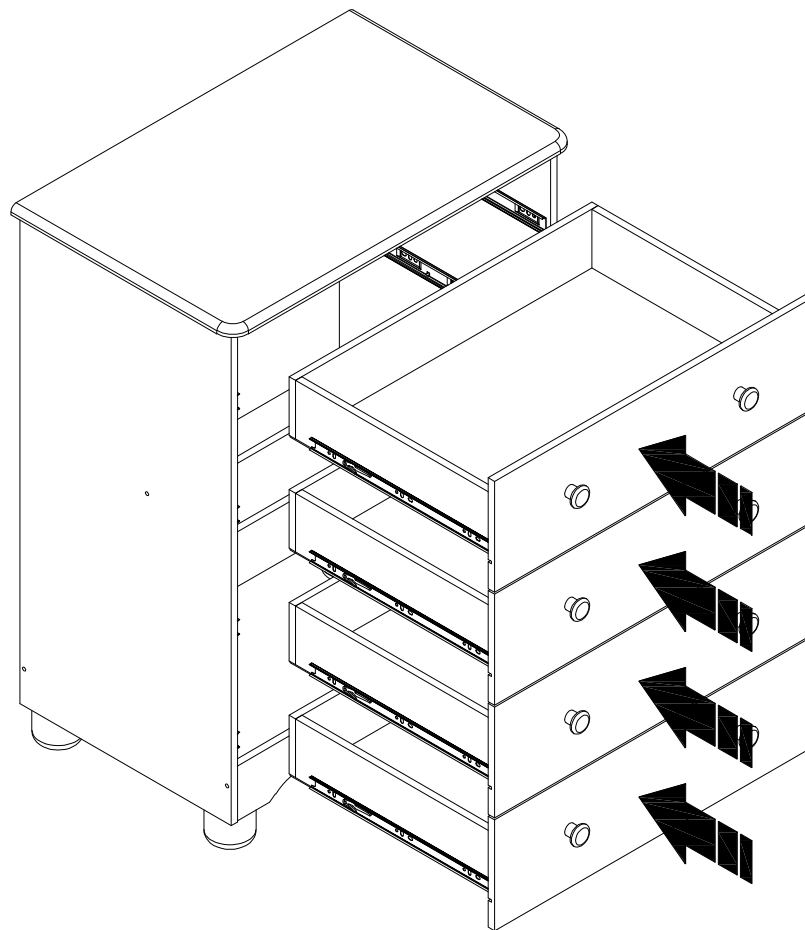

4º - FIXAÇÃO FUNDOS TRASEIROS:

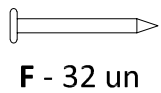

D 06 un



T 01 un

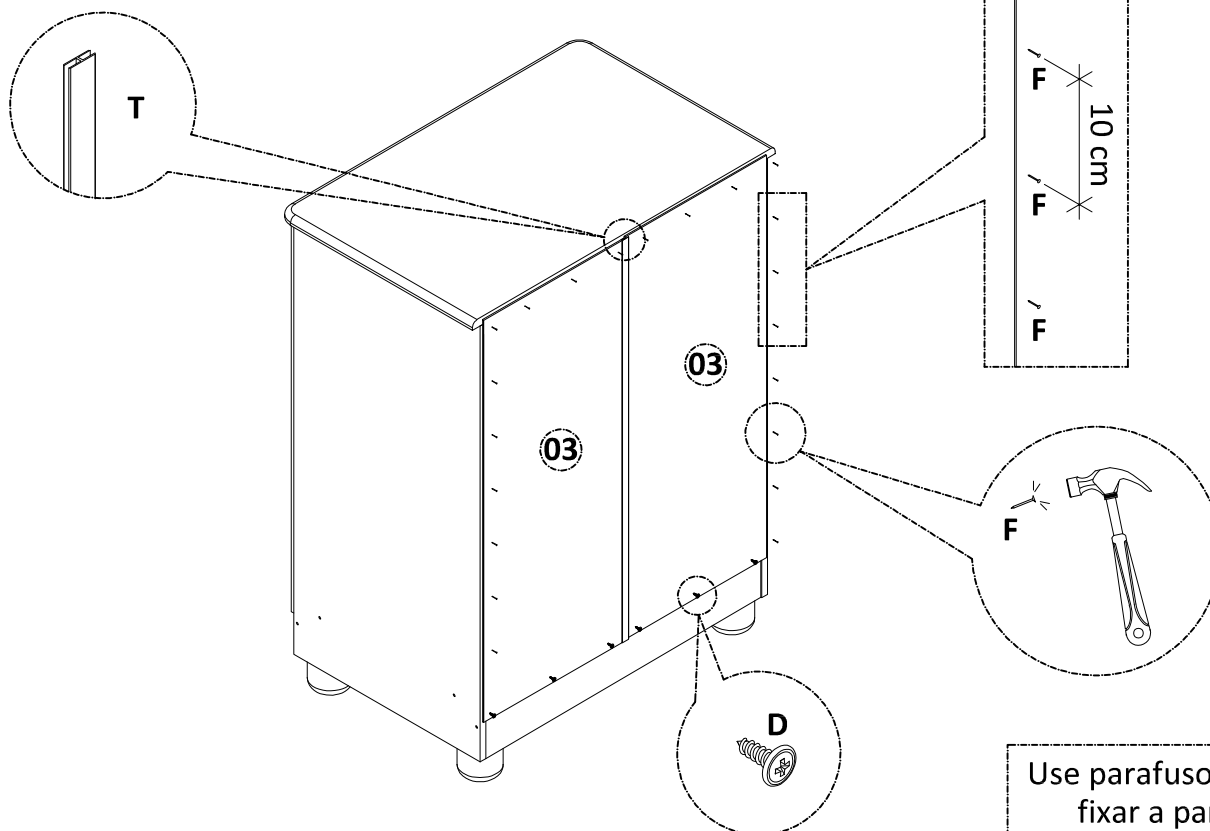

Use parafusos para
fixar a parte
inferior dos fundos
no rodapé traseiro

5º - MONTAGEM DO SISTEMA ANTITOMBAMENTO:

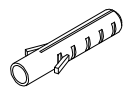

L
01 un



J
02 un



I
01 un

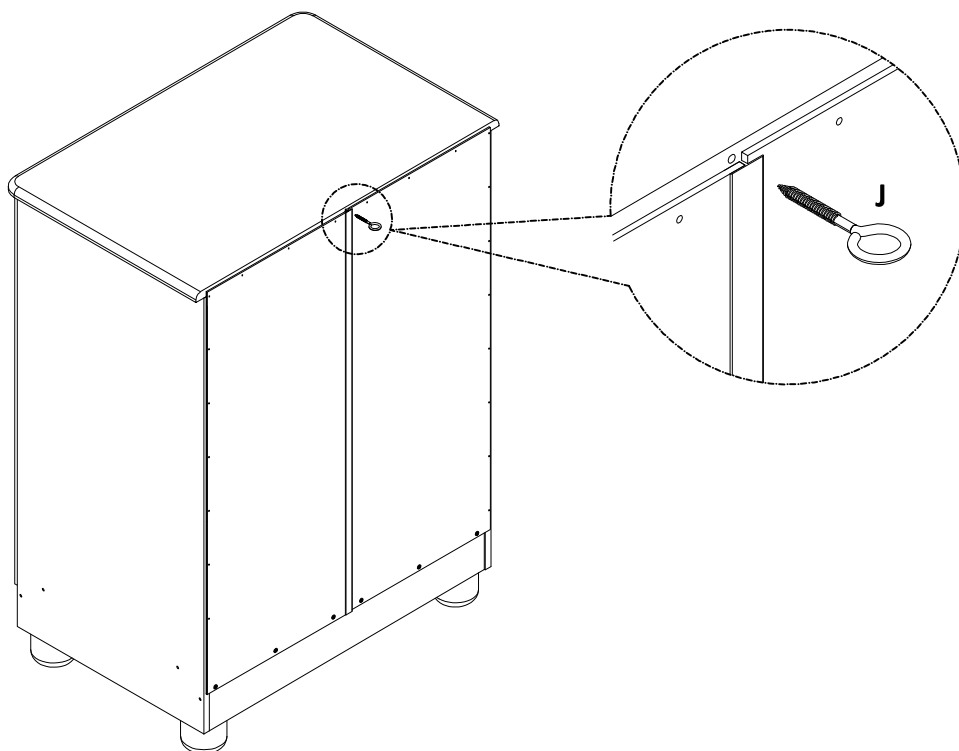

Fure a parede
com a broca p/
parede de 06 mm

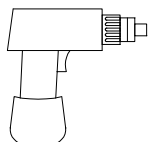

875 mm

