



Ind. e Com. de Móveis Henn  
Mondai - SC - Brasil

+55 49 3674.3500

@moveishenn  
www.henn.com.br

# INSTRUÇÕES DE MONTAGEM

INSTRUCCIONES DE MONTAJE  
ASSEMBLY INSTRUCTIONS

## Roupeiro 06 Portas / Armario de 06 Puertas / 06 Door Wardrobe

- B369-127 Nature/Off White
- B369-216 Nature/Verde HP

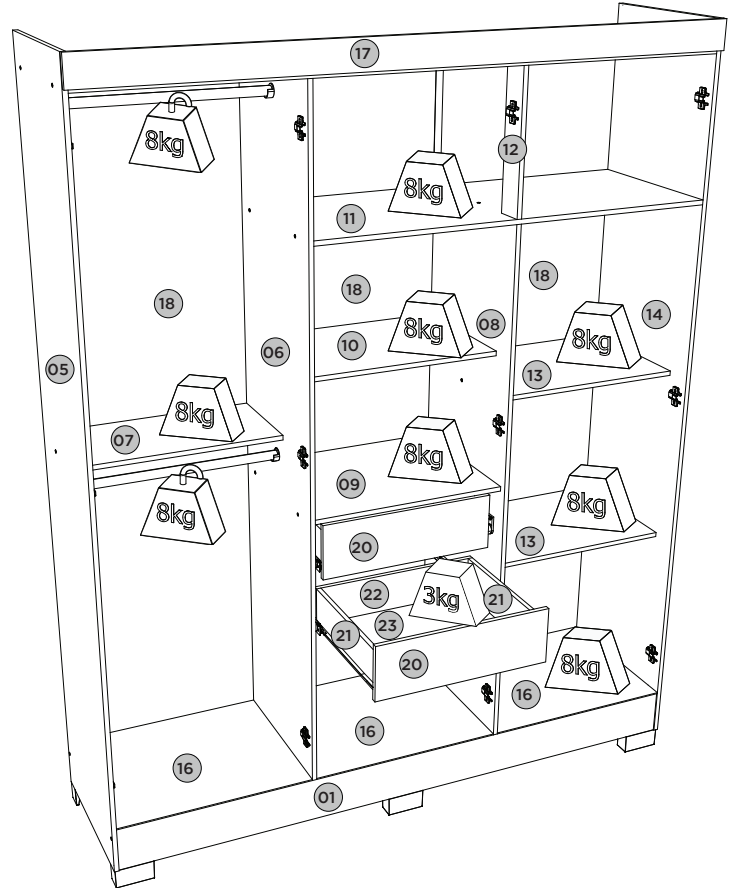

**Pesos máximos recomendados com carga distribuída**  
**Peso máximo recomendado con la carga distribuida**  
**Recommended maximum weights with evenly distributed.**

### Requisitos para montagem Requisitos para la montaje Assembly Requirements

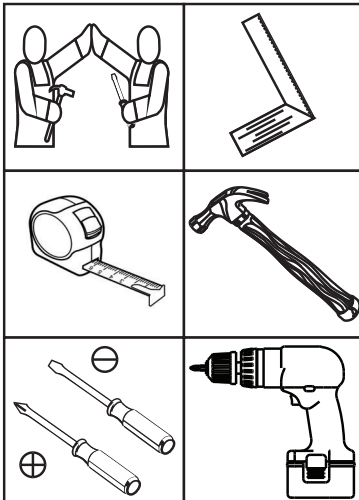

Imagens meramente ilustrativas,  
não acompanha o produto.  
Imágenes ilustrativas, no incluidas  
con el producto.  
Illustrative images, not included  
with the product.

#### AVISO

Para limpeza de seu móvel, use uma flanela seca ou umedecida, e não utilize produtos químicos que possam danificar seu produto.

#### SISTEMA DE MONTAGEM

O sistema de montagem dos produtos, funciona de acordo com a ordem crescente dos números indicados no desenho. Ex: 01, 02, 03, 04... até a conclusão da montagem.

#### ASSISTÊNCIA TÉCNICA

Para solicitação de Assistência Técnica você consumidor deverá entrar em contato com o Lojista o qual você realizou a compra deste produto e solicitar a assistência técnica das peças avariadas. A garantia abrange todas as peças, partes e componentes que eventualmente venham apresentar defeito de fabricação no prazo de 03 (três) meses, contando a partir da entrega do produto ao consumidor, mediante nota fiscal de compra. Se houver qualquer alteração na estrutura do produto ou ocorrer defeito por negligência do montador/consumidor em relação a instrução de montagem e manuseio, não será fornecido assistência técnica gratuita.

#### ADVERTENCIA

Para limpeza de su móvil, use una flanela seca o húmeda, y no utilice productos químicos que puedan dañar su producto.

#### SISTEMA DE MONTAJE

El sistema de montaje de los productos funciona de acuerdo con el orden creciente de los números indicados en el dibujo. Ej: 01, 02, 03, 04... hasta la conclusión del montaje.

#### ASISTENCIA TÉCNICA

Para solicitar Asistencia Técnica, el consumidor debe comunicarse con el Comercio que usted realizó la compra de este producto y solicita asistencia técnica para las partes dañadas. La garantía cubre todas las partes, piezas y componentes que eventualmente puedan presentar defecto de fabricación en el plazo de 03 (tres) meses, contados a partir de la entrega del producto al consumidor, mediante factura de compra. Si se produce algún cambio en la estructura del producto o se produce un defecto por negligencia del montador/consumidor en relación con las instrucciones de montaje y manipulación, no se prestará asistencia técnica gratuita.

#### NOTICE

To clean your furniture, use a dry or wet cloth, and do not use chemicals that may damage your product.

#### ASSEMBLY SYSTEM

The products' assembly system works according to the increasing order of the indicated numbers. For example: 01, 02, 03, 04 ... to the end of the assembly.

#### TECHNICAL ASSISTANCE

To request Technical Assistance, the consumer must contact the retailer from whom you purchased this product and request technical assistance for the damaged parts. The warranty covers all parts, parts and components that may eventually present a manufacturing defect within a period of 03 (three) months, counting from the delivery of the product to the consumer, by means of a purchase invoice. If there is any change in the structure of the product or defect occurs due to negligence of the assembler/consumer in relation to the assembly and handling instruction, free technical assistance will not be provided.

1

- Vista Inferior
- Vista Inferior
- Bottom view

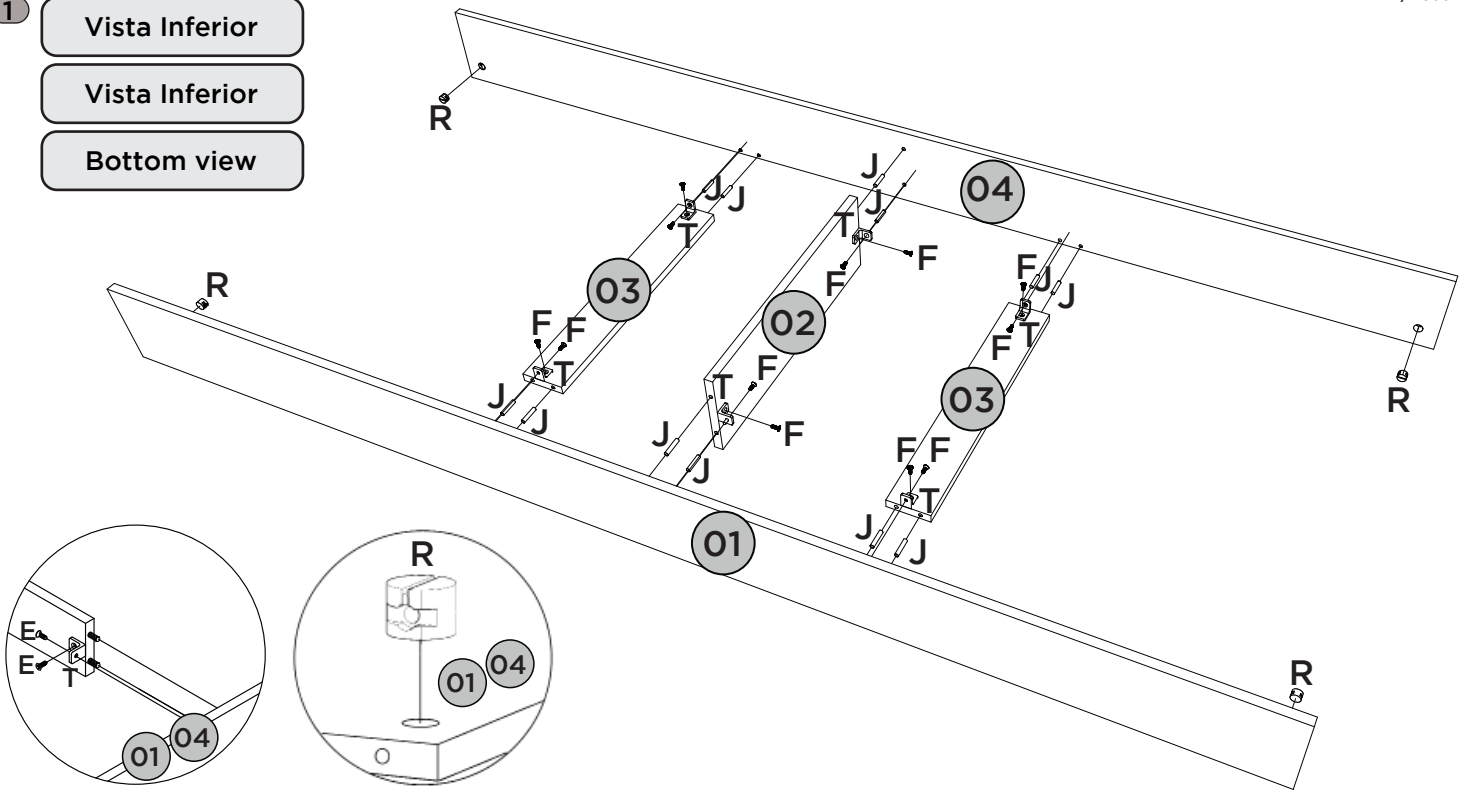

2

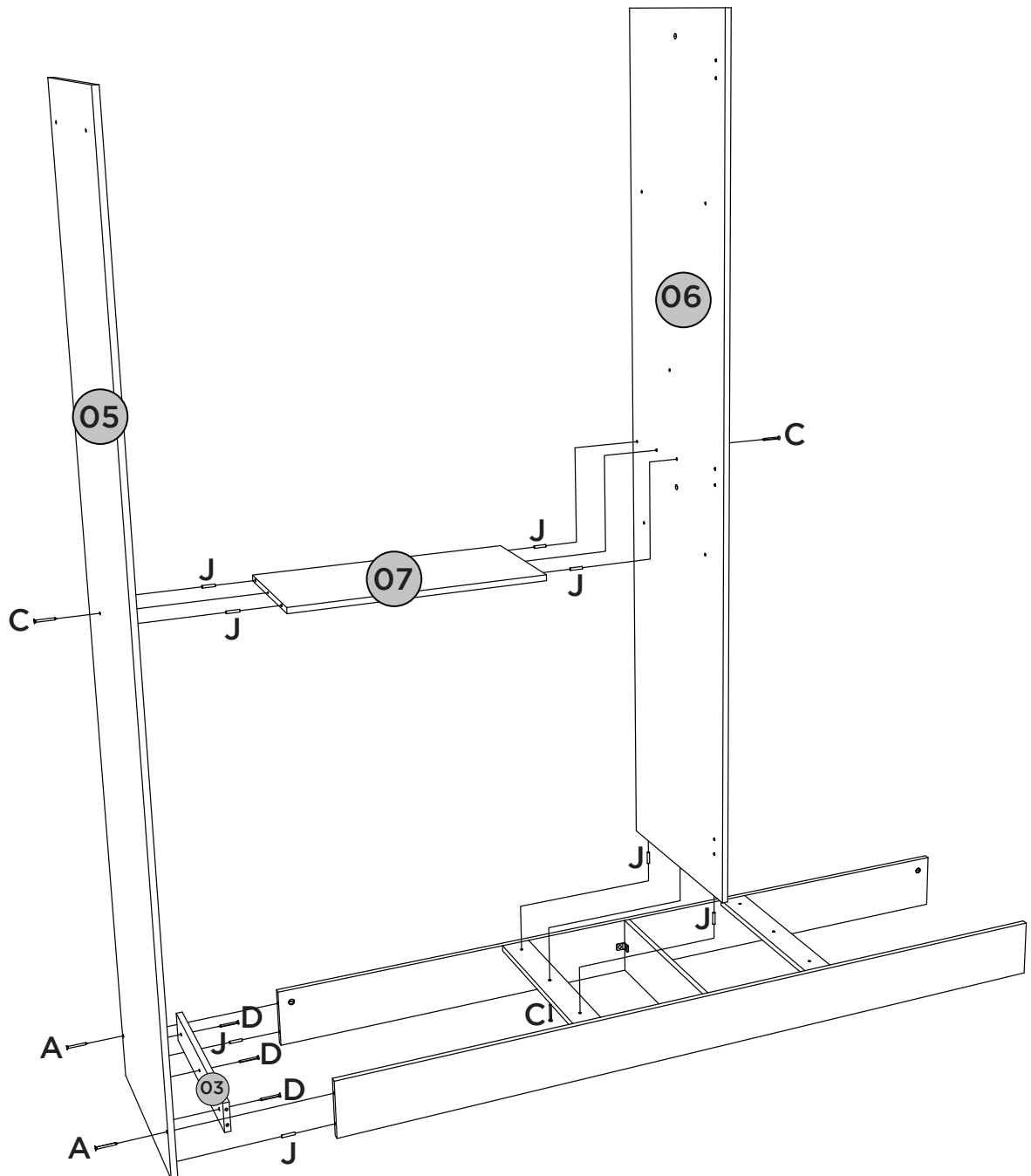

2

3

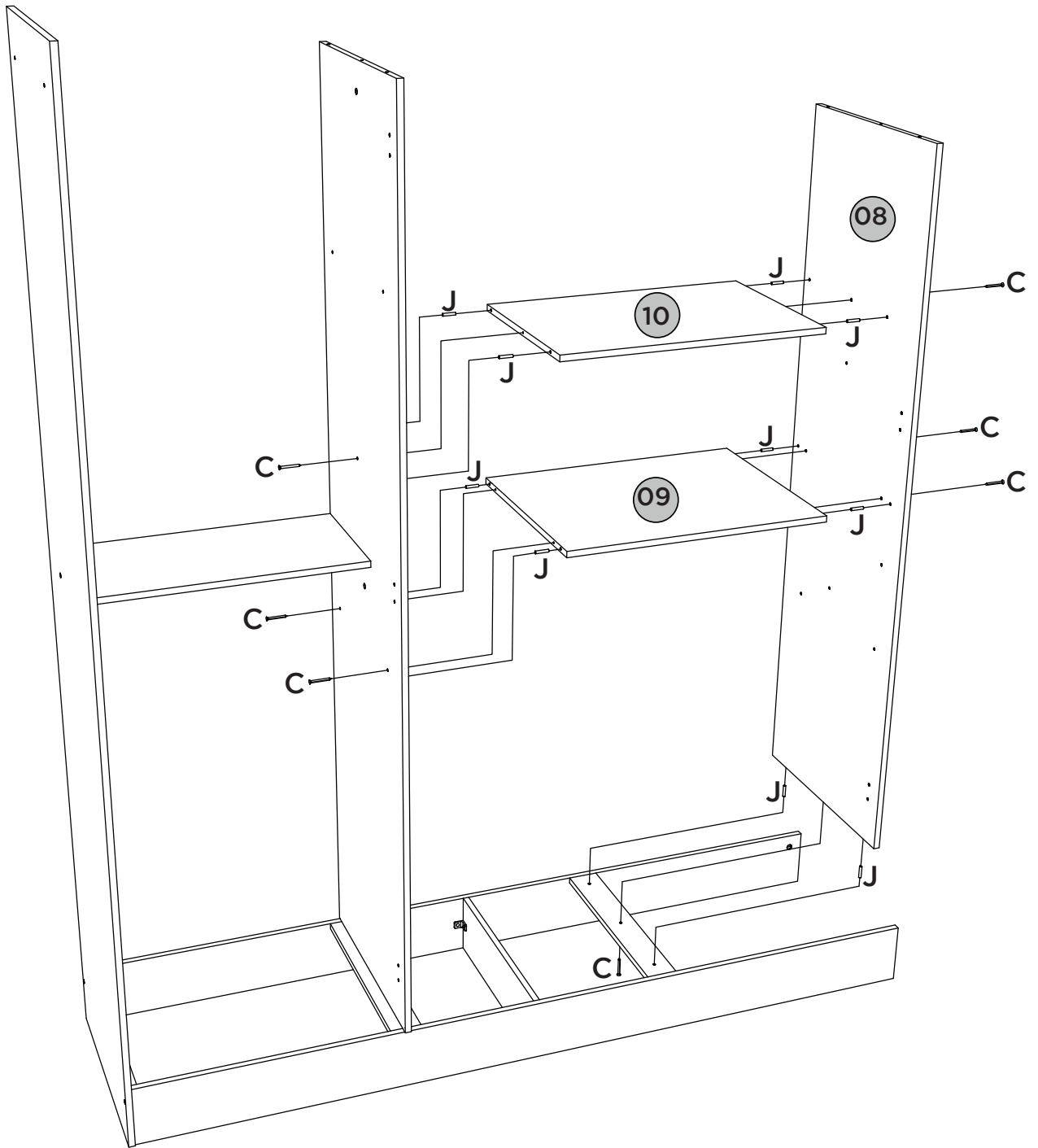

4

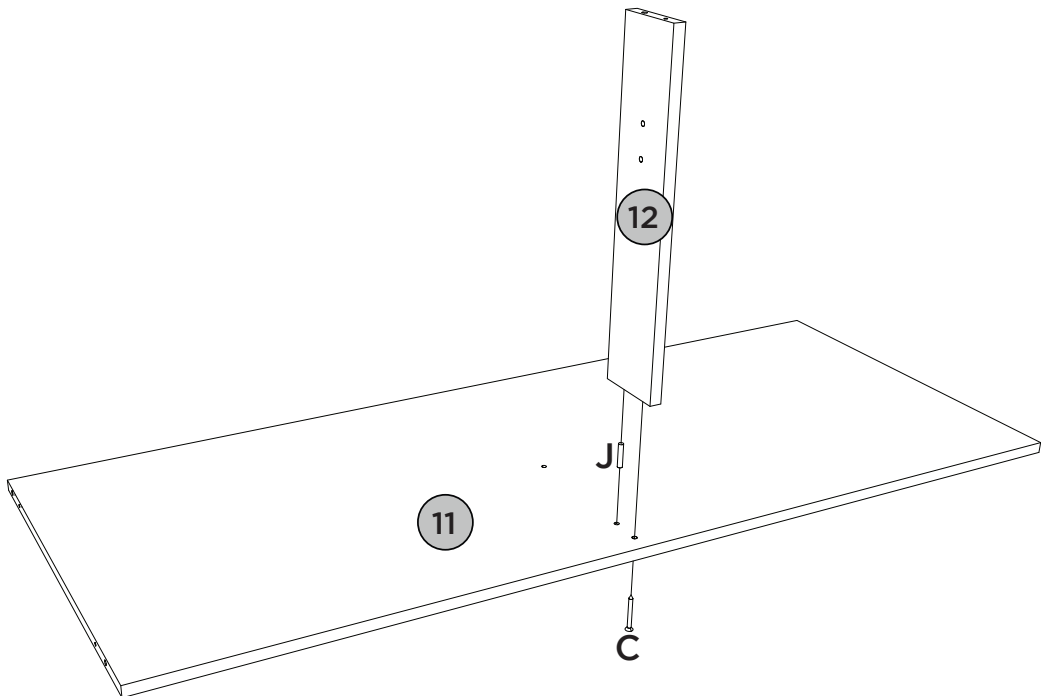

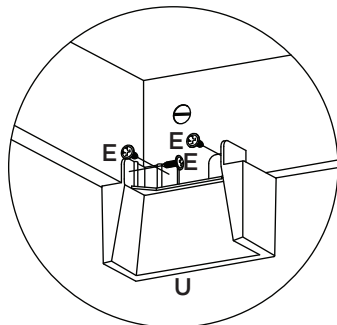
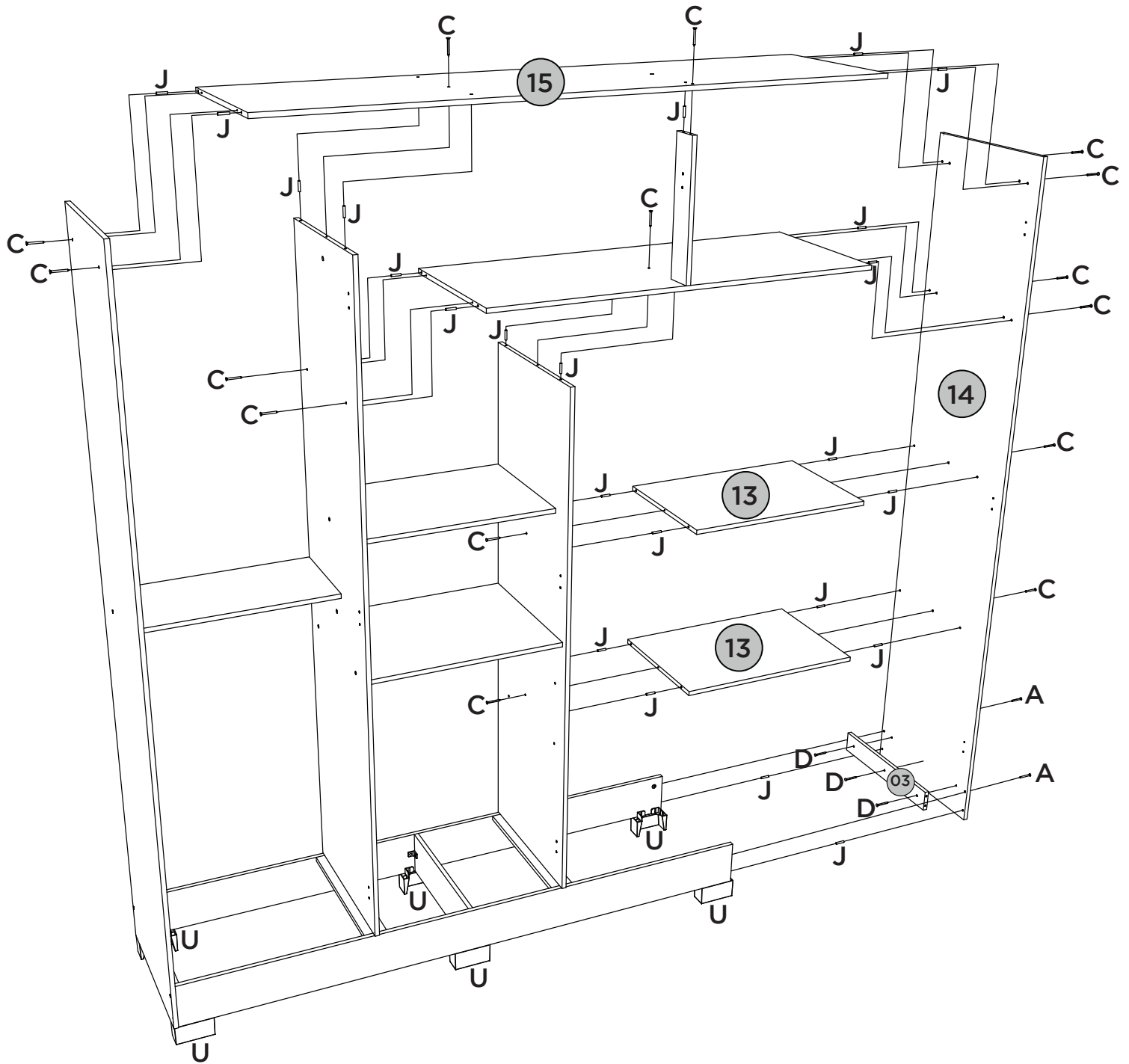

6

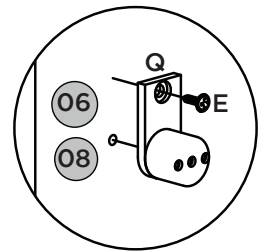
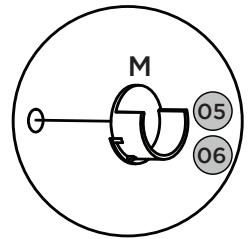
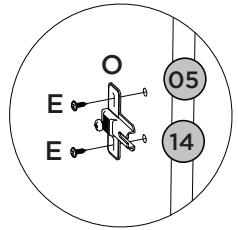
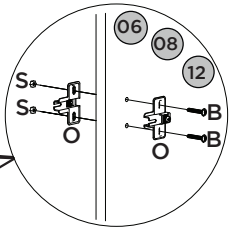
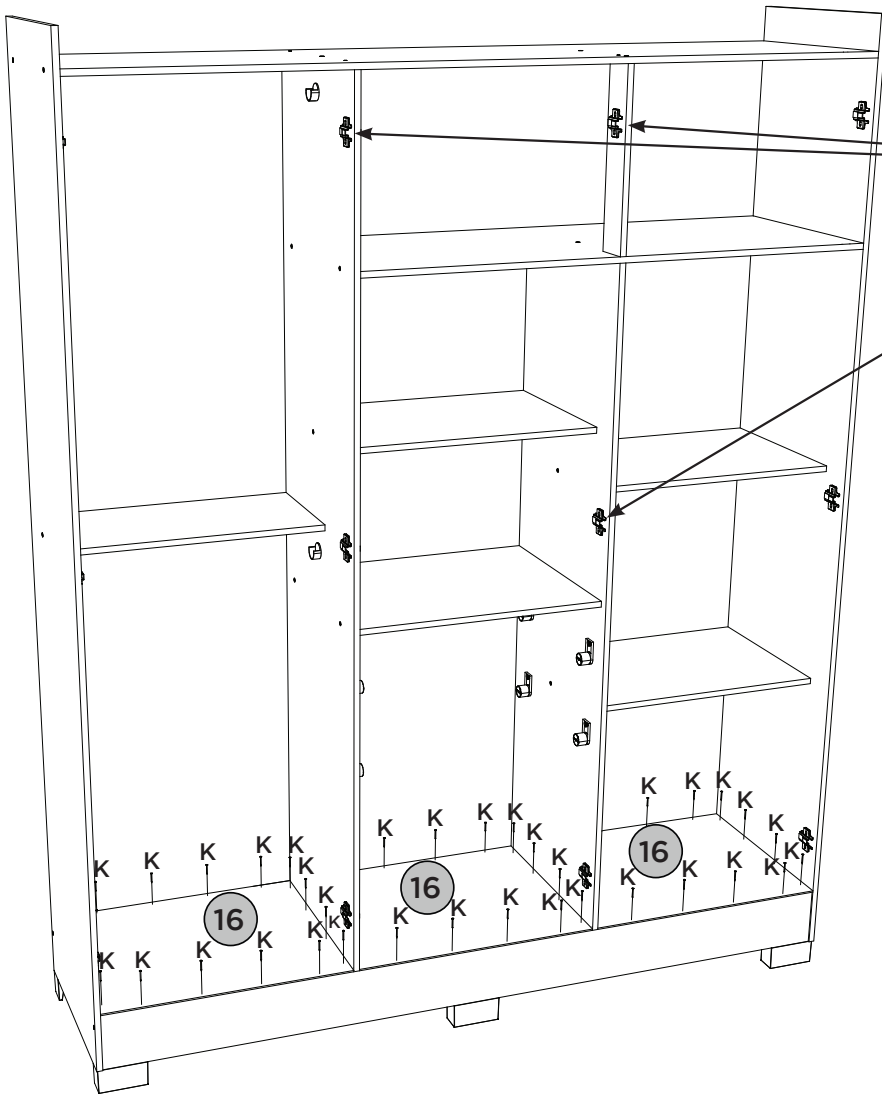

7

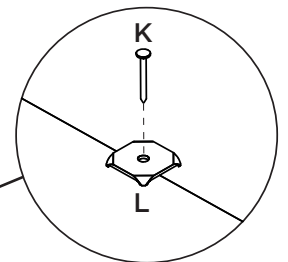
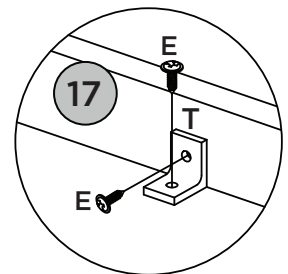
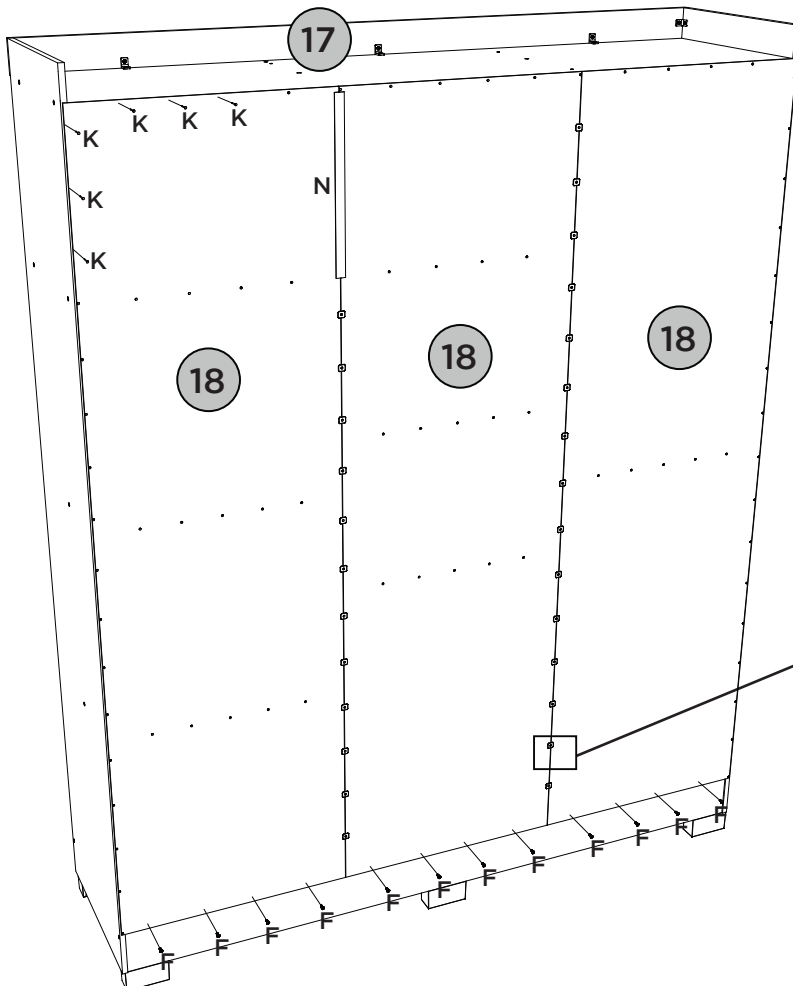

Fixar os pregos a uma distância de 120mm de um para outro.

Fijar las uñas a un distancia de 120 mm uno a otro.

Fix the nails at a distance of 120mm from one to the other

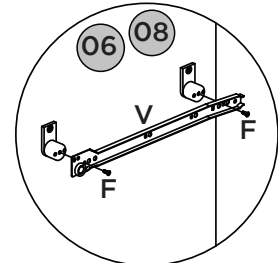
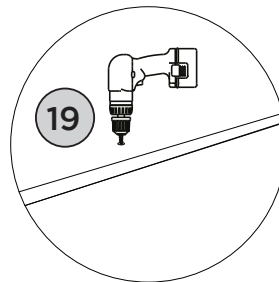
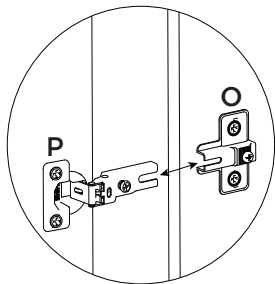
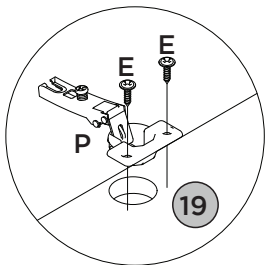
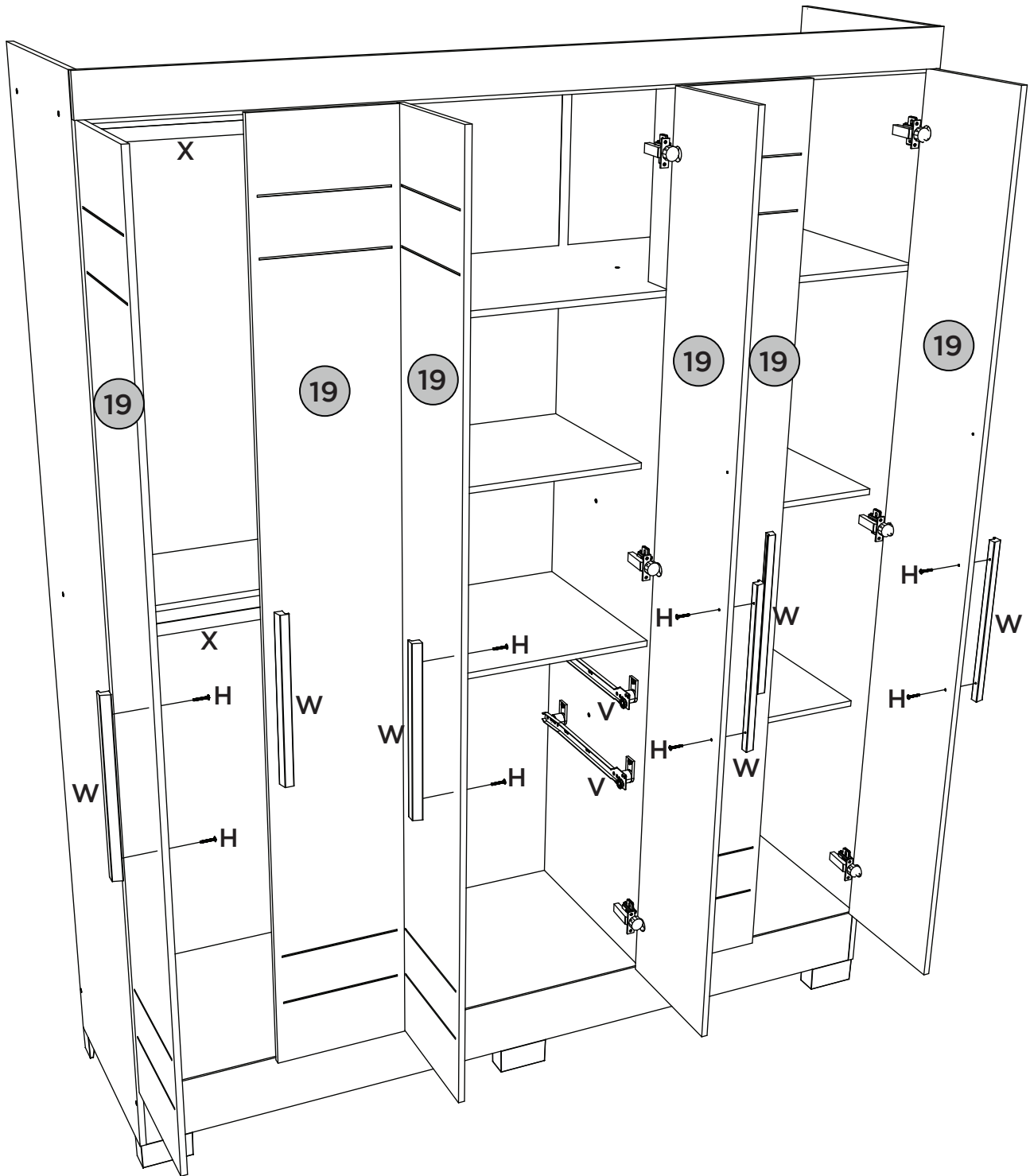

Vídeo: Instalar e regular Dobradiças

Video: Instale y ajuste las bisagras

Video: Install and adjust hinges

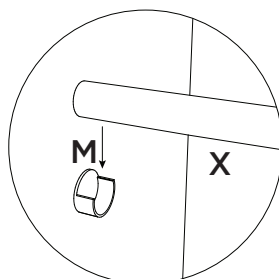

Vídeo: Dicas para instalar corredeira

Video: consejos para instalar la diapositiva

Video: Tips for installing slide

9

2x

Vista Inferior

Vista Inferior

Bottom view

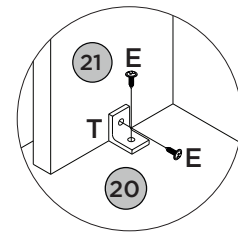
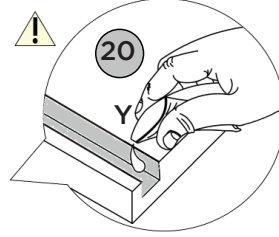
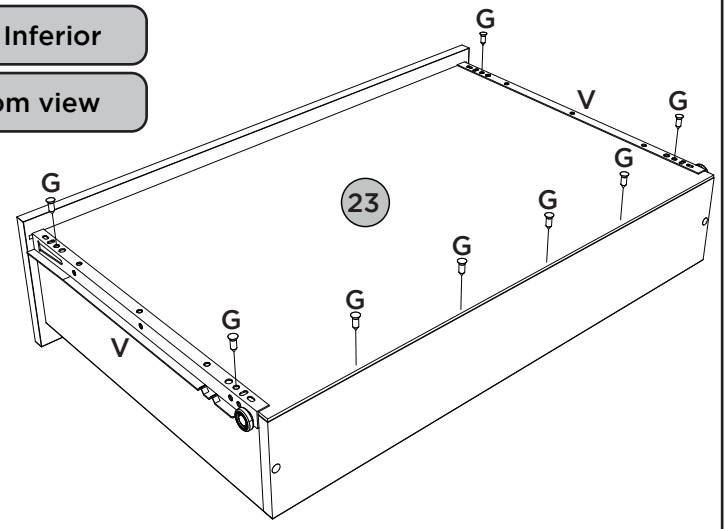
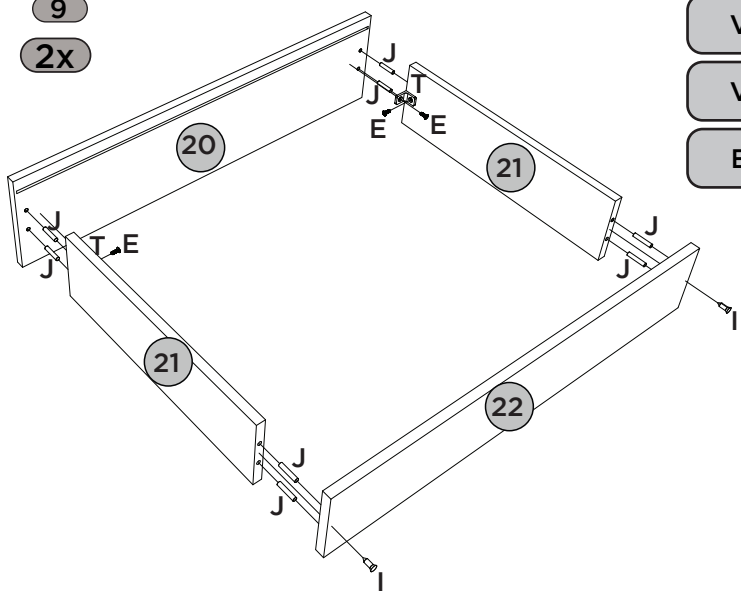



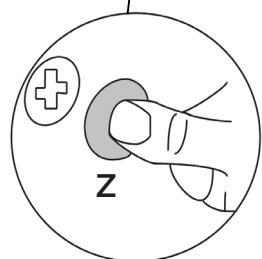
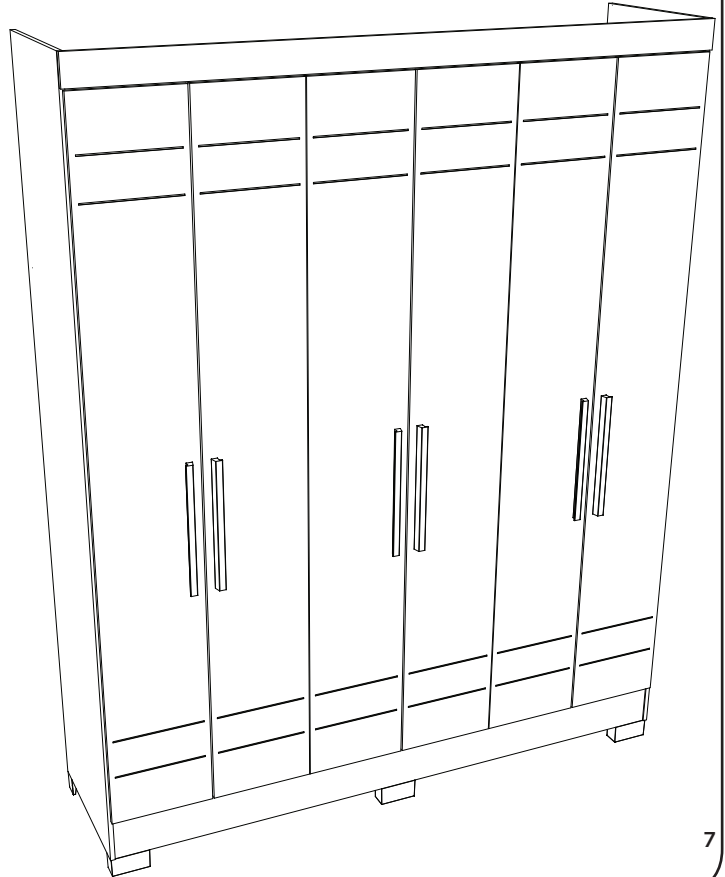
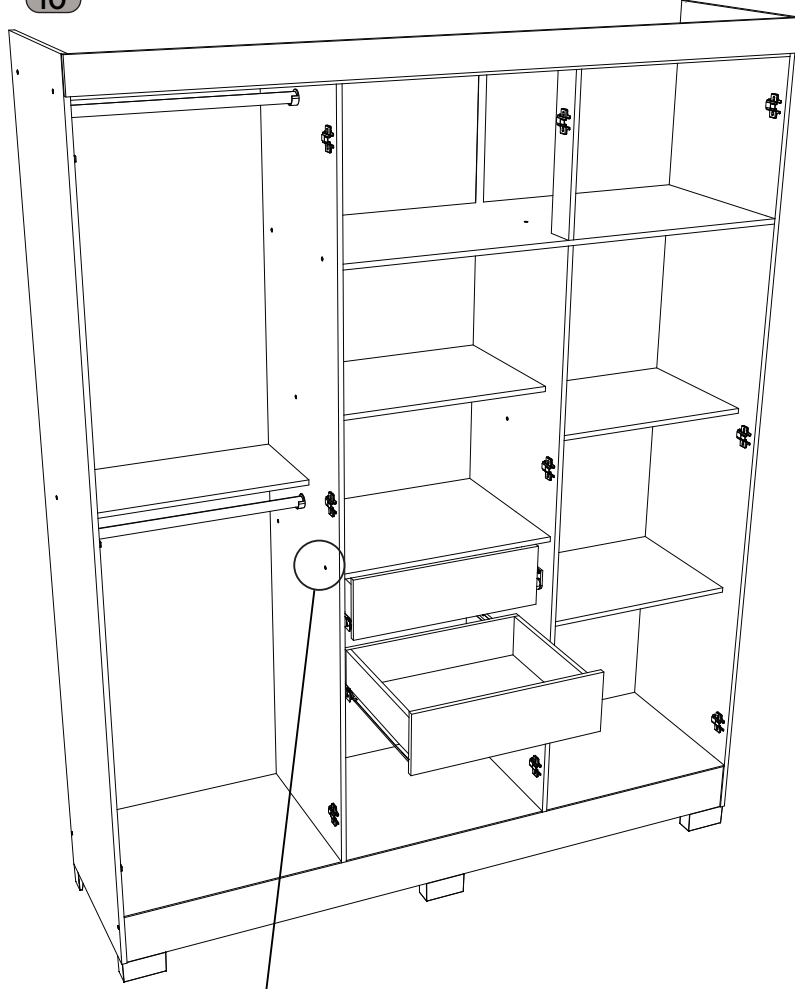















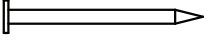

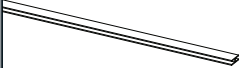

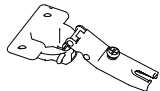
10

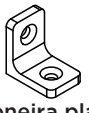
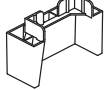

Item	Caixa Caja Box	Qty Ctd Qty	Descrição   Descripción   Description	Medidas (mm)   Dimensions (mm)   Size (measurements) (mm)
01	2/2	01	Rodapé frontal   Rodapié frontal   Front footboards	1566x120x12
02	1/2	01	Travessa Rodapé   Rodapié Bandeja   Footboard Platter	394x120x12
03	1/2	04	Travessa Base   Bandeja Base   Base Platter	394x60x12
04	2/2	01	Rodapé traseiro   Rodapié trasero   Rear footboard	1566x120x12
05	1/2	01	Lateral esquerda   Lateral izquierda   Left side	1950x420x12
06	1/2	01	Divisão esquerda   División izquierda   Left division	1749x420x12
07	1/2	01	Prateleira Menor   Estante más pequeño   Smaller Shelf	514x250x12
08	1/2	01	Divisão direita   División derecha   Right division	1387x420x12
09	1/2	01	Tampo das Gavetas   Cubre los cajones   Drawer Top	514x400x12
10 = 13	1/2	01	Prateleira   Estante   Shelf	514x350x12
11	1/2	01	Chão do maleiro   piso del baúl   Floor of the closet top shelf	1040x420x12
12	1/2	01	Ripa do maleiro   listón maleiro   maleiro slat	350x73x12
13 = 10	1/2	02	Prateleira   Estante   Shelf	514x350x12
14	1/2	01	Lateral direita   Lateral derecha   Right side	1950x420x12
15	1/2	01	Tampo   Cubrir   Cover	1566x420x12
16	1/2	03	Base 3mm   Base 3mm   Base 3mm	514x420x3
17	2/2	01	Chapéu   Sombrero   Hat	1588x73x12
18	2/2	03	Fundo   Fondo   Background	1777x527x3
19	2/2	06	Porta   Puerta   Door	1758x260x12
20	1/2	02	Frente de Gaveta   Frente del Cajón   Drawer Front	456x145x12
21	1/2	04	Lado de gaveta   Lado del cajón   Drawer side	350x100x12
22	1/2	02	Ripa de trás   Listón trasero   Rear batten	439x100x12
23	1/2	02	Fundo de gaveta recortado   Fondo de cajón recortado   Cropped drawer bottom	438x367x3

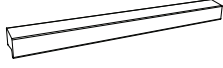
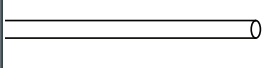
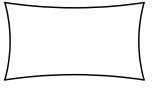
FERRAGENS | HERRAJES | HARDWARE

<b>A</b> 04x  Parafuso 4,5x50mm CHT. Tornillo 4,5x50mm CHT. Screw 4,5x50mm CHT.	<b>B</b> 12x  Parafuso 4,0x22mm FLA MET. Tornillo 4.0x22mm FLA MET. Screw 4.0x22mm FLA MET.	<b>C</b> 26x  Parafuso 3,5x40mm CHT. Tornillo 3,5x40mm CHT. Screw 3,5x40mm CHT.	<b>D</b> 06x  Parafuso 3,0x20mm CHT. Tornillo 3,0x20mm CHT. Screw 3,0x20mm CHT.	<b>E</b> 104x  Parafuso 3,5x12mm FLA. Tornillo 3,5x12mm FLA. Screw 3,5x12mm FLA.
<b>F</b> 20x  Parafuso 3,5x12mm CHT. Tornillo 3,5x12mm CHT. Screw 3,5x12mm CHT.	<b>G</b> 16x  Parafuso 3,0x16mm CHT. Tornillo 3,0x16mm CHT. Screw 3,0x16mm CHT.	<b>H</b> 12x  Parafuso 3,5x25mm FLA. Tornillo 3,5x25mm FLA. Screw 3,5x25mm FLA.	<b>I</b> 04x  Prego 12x12mm Anelado Clavo 12x12mm Anillado Ringed Nails 12x12mm	<b>J</b> 70x  Cavilha 5x25mm Cinta 5x25mm Dowel 5x25mm
<b>K</b> 143x  Prego 10x10mm Clavo 10x10mm Nail 10x10mm	<b>L</b> 25x  Fixador de fundos Fijador de fondos Bottom fixer	<b>M</b> 04x  Suporte cabideiro Soporte de percha Coat hanger support	<b>N</b> 01x  Perfil "I" 360mm Perfil "I" 360mm "I" profile 360mm	<b>O</b> 18x  Calço metal 5mm Calzado metálico 5mm 5mm metal shim
<b>P</b> 18x  Dobradiça metal L2 26 mm Bisagra metálica L2 26 mm Metal hinge L2 26 mm	<b>Q</b> 08x  Distanciador de corrediça Distanciador de deslizamiento Sliding spacer	<b>R</b> 04x  Porca cilíndrica Tuerca cilíndrica Cylindrical nut	<b>S</b> 12x  Porca sextavada Tuerca hexagonal Hexagon nuts	<b>T</b> 15x  Cantoneira plástica Cantonera plástica Plastic angle brackets
<b>U</b> 06x  Pé "U" 50x40x100mm Pie "U" 50x40x100mm 50x40x100mm "U" feet	<b>V</b> PAR 02x  Corrediça metal 350mm Corredera metal 350mm Sliding metal 350mm	<b>W</b> 06x  Puxador Revestido MDF 330mm Tirador MDF Revestido 330mm MDF Coated Handle 330mm	<b>X</b> 02x  Cabideiro Madeira 508mm Cabezal Madera 508mm 508mm wooden hanger	<b>Y</b> 01x  Sachê de cola Bolsa de pegamento Glue bag
<b>Z</b> 26x  Adesivo tapa parafuso 10mm Adhesivo tapón de tornillo 10mm Bolt cover adhesive 10mm	<b>AA</b> 01x  Etiqueta resinada Briz Etiqueta resinada Briz Briz resin label			