

07 Fixação do Tampo e da Moldura Superior e Lateral

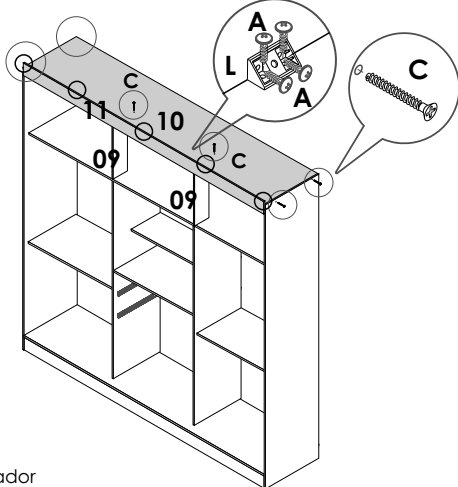

Sr. Montador
Favor fixar o conector de montagem
a 5mm da Borda fileada da Moldura Superior

08 Fixação das Costas

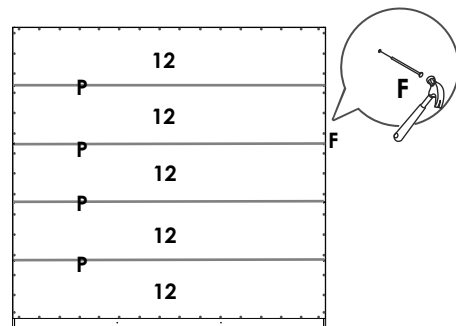

09 Montagem das Gavetas

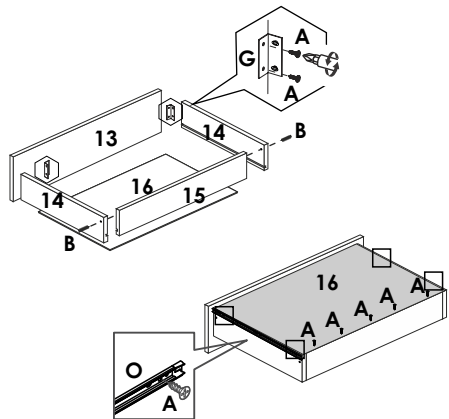

10 Montagem das Portas

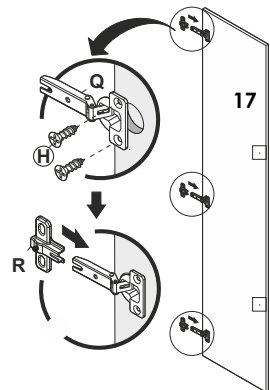

11 Fixação do Suporte Cabideiro

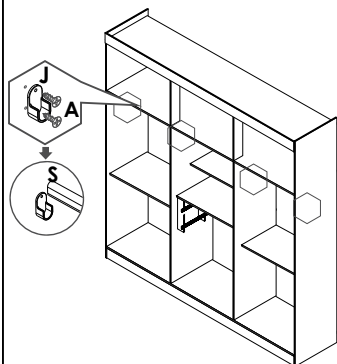

12 Colocação das Gavetas

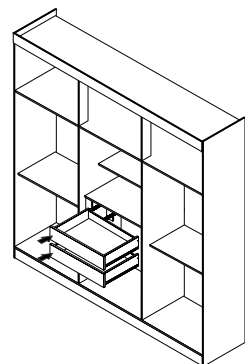

13 Fixação das portas

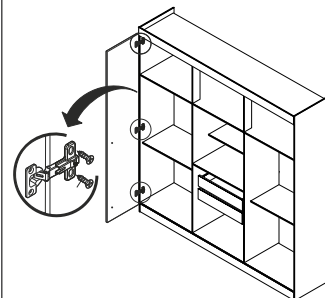

Sallêto

ROUPEIRO
RECIFE
6 PORTAS

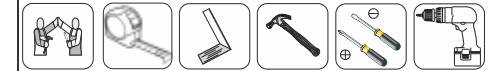

Atualizado em: 16/01/2024 **Ao solicitar assistência, informe o número da peça e a letra do acessório**

Av. Jesus Candian, 800–Caixa Postal 116
CEP36503-258–Mangueira Rural–Ubá / MG
www.salletomoveis.com.br



















(32) 3541-6777



LISTA DE PEÇAS

CÓD.	Nº.	DESCRIÇÃO	COMP.	LARG.	ESP.	QT
15094	01	Rodapé Frontal Pintado	1788	100	12	1
15093	02	Rodapé Traseiro Cru	1788	100	12	1
15098	03	Travessa Rodapé Cru	405	100	12	2
15088	04	Lateral Esq./ Dir.	2000	450	12	2
15089	05	Base Inferior	1788	450	12	1
15090	06	Divisão Interna	1348	450	12	2
15091	07	Prateleira Menor	588	330	12	4
15089	08	Prateleira do Maleiro	1788	450	12	1
15096	09	Batente da Porta	450	100	12	2
15089	10	Tampo Superior	1788	450	12	1
15099	11	Moldura Superior	1807	70	12	1
15101	12	Costas	1808	363	3	5
15095	13	Frete da Gaveta	534	155	12	2
15100	14	Lateral da Gaveta	300	110	15	4
15097	15	Traseiro da Gaveta	484	70	12	2
15102	16	Fundo da Gaveta	499	307	3	2
15092	17	Portas	1830	297	12	6
15103	18	Kit Ferragens				

LISTA DE FERRAGENS

A  Parafuso 3,5x12 X144	B  Parafuso 3,5x40 (Traseiro Gaveta) X04	C  Parafuso 5x40 (montagem estrutura) X36
D  Parafuso 3,5x35 X08	E  Parafuso 3,5x25 (Puxador Porta) X18	F  Prego 8x8 X105
G  Cantoneira 4 furos para gaveta X08	H  Cavilha 6x30 X14	I  Cavilha 6x50 X08
J  Suporte Cabide X04	K  Sapata X08	L  Conector X04
M  Calço Corrediça X08	N  Parafuso 3,5x16 X16	O  Perfil H 1808 X04
P  Corrediça Telescopica 300 mm X02	Q  Dobradiça X18	R  Calço Dobradiça X18

Medidas em mm

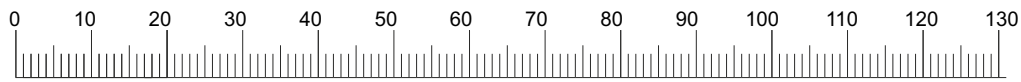

Ao solicitar assistência, informe o número da peça e a letra do acessório

01 Início da Montagem

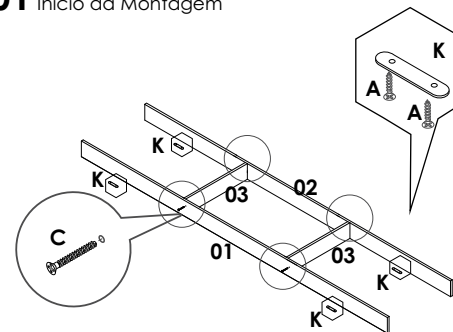

02 Montagem das Laterais

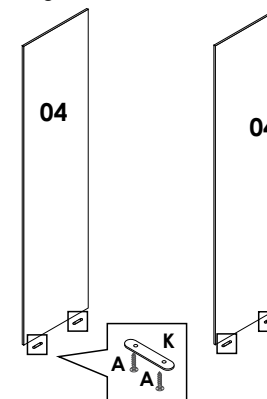

03 Montagem da Lateral Direita e Esquerda

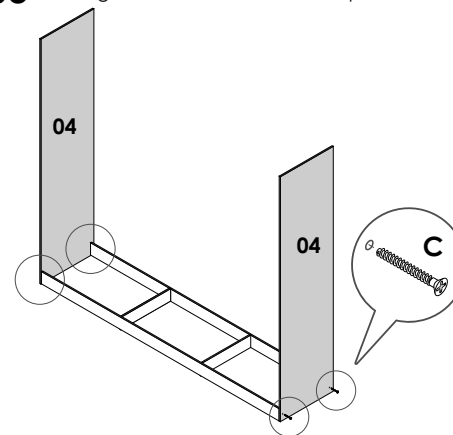

04 Fixação das Divisões

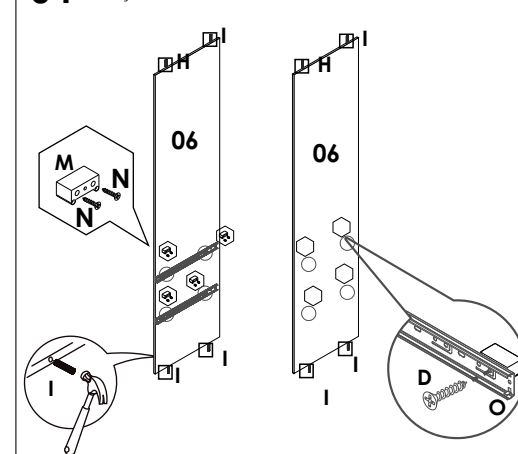

05 Montagem das Divisões na Base

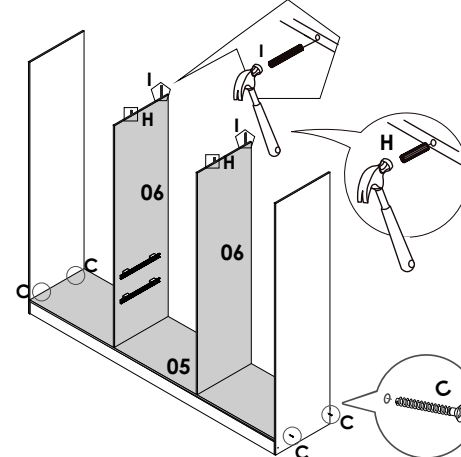

06 Montagem das Prateleiras e do Tampo Superior

