

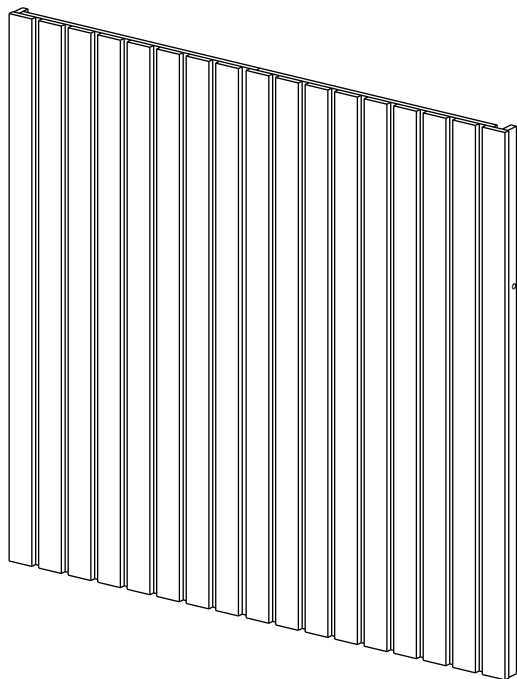

móveis

***Cabeceira Ripada Maracá***  
***Slat Headboard Maracá***  
***Cabecera Ripada Maracá***



*Embalagem com 2 Painéis*  
*Package with 2 Panels*  
*Embalaje con 2 Paneles*

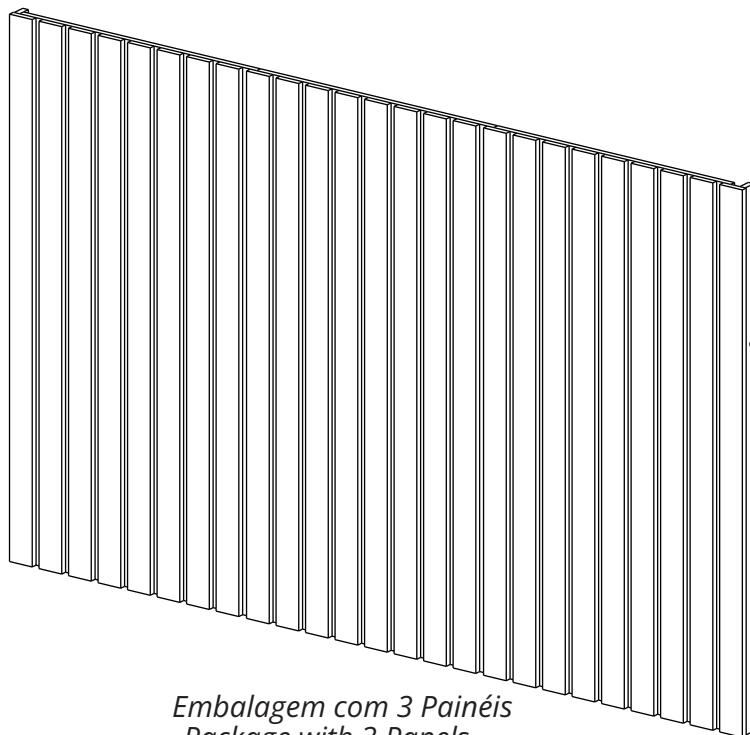

*Embalagem com 3 Painéis*  
*Package with 3 Panels*  
*Embalaje con 3 Paneles*

[www.jbbechara.com.br](http://www.jbbechara.com.br)  
SAC +55 17 3272-9190  
[assistencia@jbbechara.com.br](mailto:assistencia@jbbechara.com.br)  
[export@jbbechara.com.br](mailto:export@jbbechara.com.br)

# ACESSÓRIOS

ACCESSORIES - ACCESORIOS



## Embalagem com 2 Painéis Package with 2 Panels Embalaje con 2 Paneles

PARAFUSO  
SCREW  
TORNILLO

**A**  
04 x

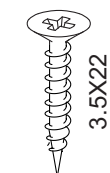

PARAFUSO  
SCREW  
TORNILLO

**B**  
08 x



PARAFUSO  
SCREW  
TORNILLO

**C**  
04 x



PARAFUSO  
SCREW  
TORNILLO

**D**  
12 x

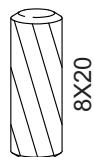

CAVILHA  
DOWEL  
TARUGO

**E**  
04 x



CANTONEIRA  
ANGLE BRACKET  
SOPORTE ANGULAR

**F**  
06 x

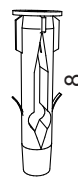

BUCHA DE PAREDE  
WALL PLUG FIXING  
TACO DE PARED

**G**  
04 x



ADESIVO  
ADHESIVE  
ADHESIVO

**H**  
02 x

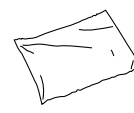

COLA  
GLUE  
PEGAMENTO

**I**  
01 x



## Embalagem com 3 Painéis Package with 3 Panels Embalaje con 3 Paneles

PARAFUSO  
SCREW  
TORNILLO

**A**  
06 x

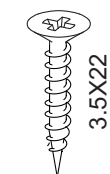

PARAFUSO  
SCREW  
TORNILLO

**B**  
12 x



PARAFUSO  
SCREW  
TORNILLO

**C**  
04 x



PARAFUSO  
SCREW  
TORNILLO

**D**  
12 x

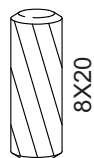

CAVILHA  
DOWEL  
TARUGO

**E**  
06 x



CANTONEIRA  
ANGLE BRACKET  
SOPORTE ANGULAR

**F**  
06 x

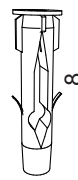

BUCHA DE PAREDE  
WALL PLUG FIXING  
TACO DE PARED

**G**  
06 x

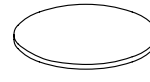

ADESIVO  
ADHESIVE  
ADHESIVO

**H**  
02 x



COLA  
GLUE  
PEGAMENTO

**I**  
01 x



### CONSERVANDO O SEU MÓVEL / MAINTAINING YOUR FURNITURE / MANTENIENDO SU MOBILIARIO LIMPEZA DO MÓVEL / CLEANING THE FURNITURE / LIMPIANDO SU MOBILIARIO

Na remoção da poeira utilizar flanela limpa e levemente umedecida, em seguida flanela seca para remoção da umidade.  
*To remove dust use a clean flannel slightly moistened and afterwards a dry flannel to remove the humidity.*  
Para limpiar el polvo utiliza una flanela limpia y humedecida y después una flanela seca para quitar la humedad.

### RECOMENDAÇÕES DE USO / USE RECOMMENDATIONS / RECOMENDACIONES DE USO

Não expor a luz solar e locais úmidos.  
*Do not expose to sun light and humid places.*  
No exponga a la luz solar y lugares húmedos.

Não encostar o móvel na parede para evitar transmissão de umidade.  
*Do not lean the furniture in the wall to avoid humidity transmission.*  
No apoye el mobiliario en la pared evitar la transmisión de humedad.

Não movimentar o móvel.  
*Do not move your furniture.*  
No mueva su mobiliario.

# PEÇAS

PIECES - PIEZAS

## PORTUGUÊS

- 01- Painel
- 02- Ripas
- 03- Ripa de Acabamento
- 04- Lateral de Acabamento
- 05- Suporte de Parede
- 06- Apoio Inferior

## ENGLISH

- 01- Panel
- 02- Slats
- 03- Finishing Slat
- 04- Finishing Side
- 05- Wall Support
- 06- Bottom Support

## ESPAÑOL

- 01- Panel
- 02- Listones
- 03- Listón de Acabamiento
- 04- Acabamiento Lateral
- 05- Apoyo de Pared
- 06- Apoyo Inferior

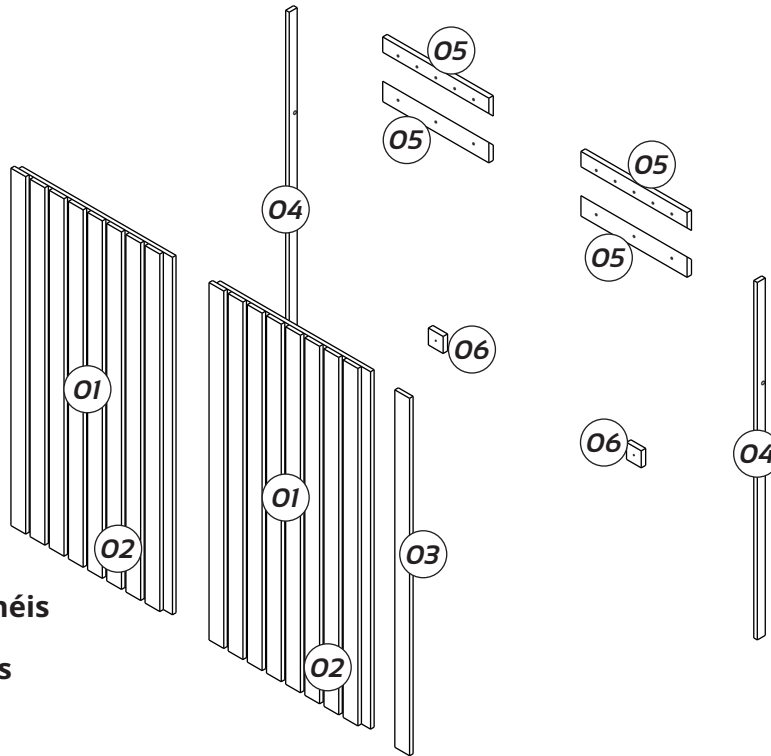

**Embalagem com 2 Painéis**  
**Package with 2 Panels**  
**Embalaje con 2 Paneles**

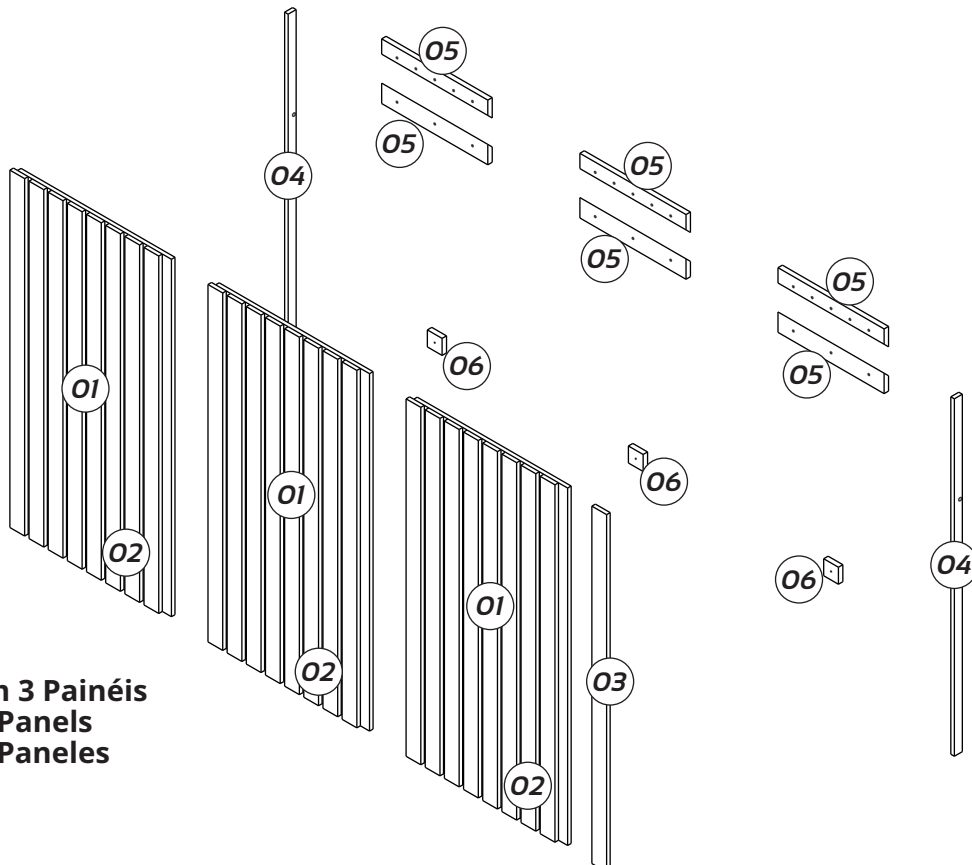

**Embalagem com 3 Painéis**  
**Package with 3 Panels**  
**Embalaje con 3 Paneles**

# PRÉ-MONTAGEM

PRE ASSEMBLY - PRÉ-MONTAJE

## IMPORTANTE

ATTENTION - IMPORTANTE

A MONTAGEM DEVE SER REALIZADA POR UM PROFISSIONAL DE MONTAGEM.  
ASSEMBLY MUST BE CARRIED OUT BY AN ASSEMBLY PROFESSIONAL.  
EL MONTAJE DEBE SER HECHO POR UN MONTADOR DE MUEBLES.

**1**

Todos os Painéis 01 devem ser preparados da maneira que se mostra.

All Panels 01 must be prepared as shown.

Todos los Paneles 01 deben prepararse como se muestra.

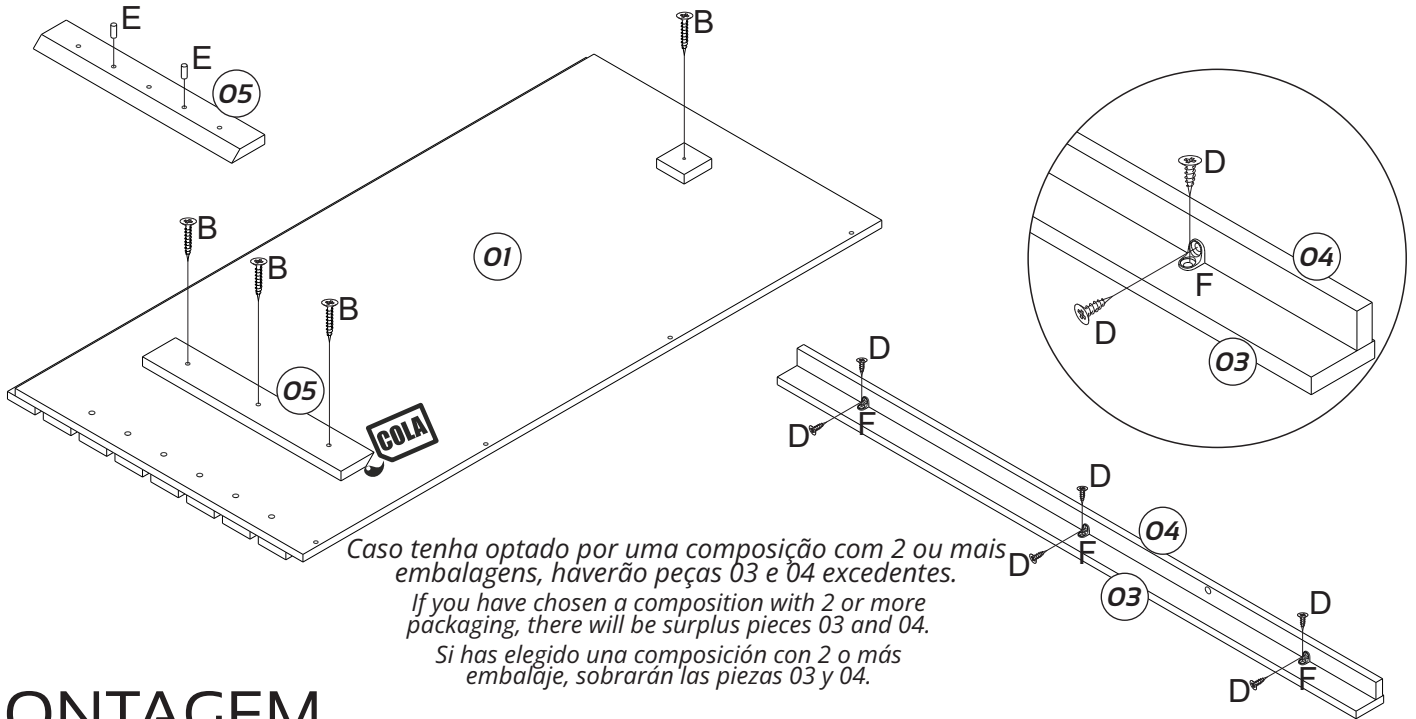

Caso tenha optado por uma composição com 2 ou mais embalagens, haverá peças 03 e 04 excedentes.

If you have chosen a composition with 2 or more packaging, there will be surplus pieces 03 and 04.

Si has elegido una composición con 2 o más embalaje, sobrarán las piezas 03 y 04.

# MONTAGEM

ASSEMBLY - MONTAJE

**1**

Utilize duas peças 05 como guias para fixar o conjunto 03/04.

Use two pieces 05 as guides to fix the set 03/04.

Utilice dos piezas 05 como guías para fijar el conjunto 03/04.

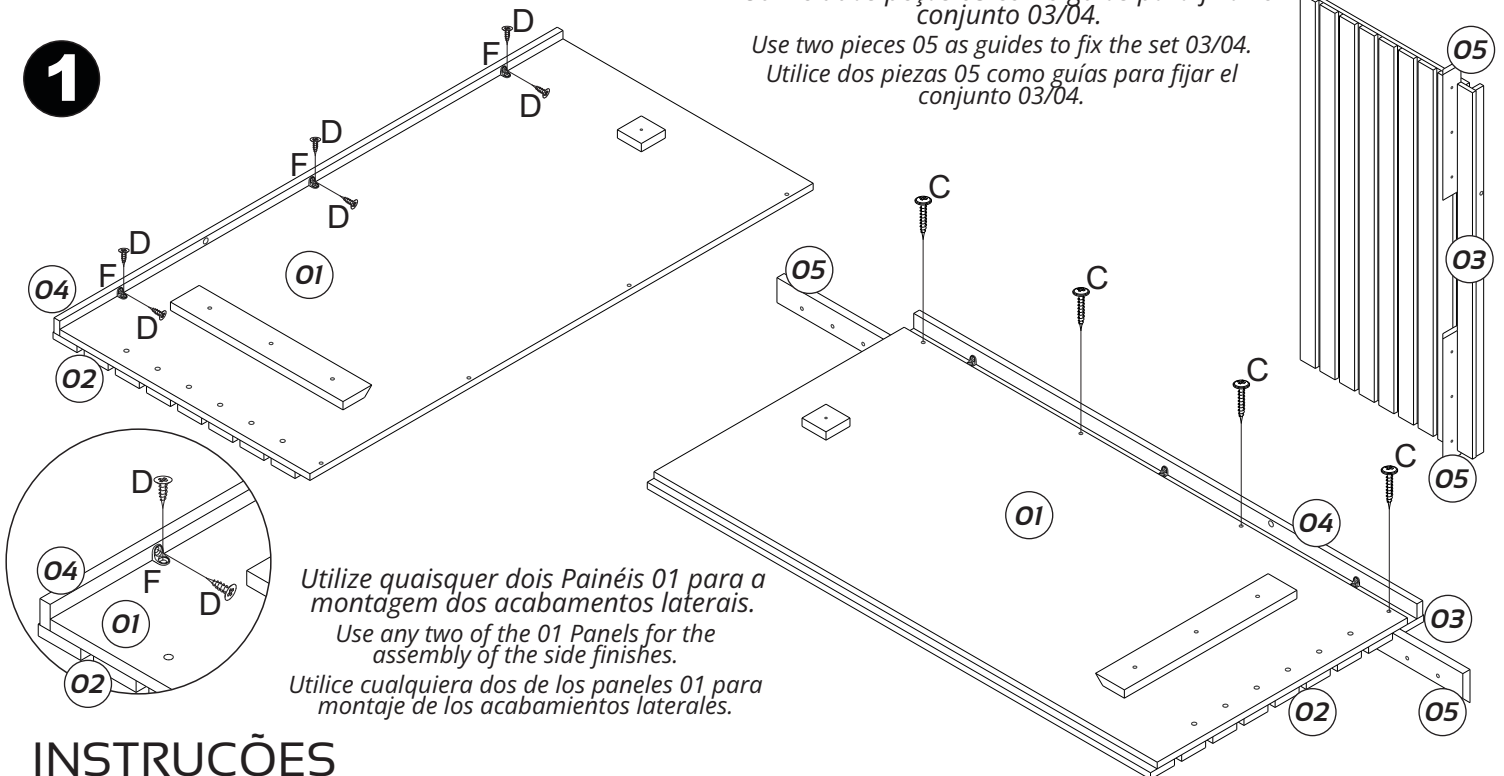

Utilize quaisquer dois Painéis 01 para a montagem dos acabamentos laterais.

Use any two of the 01 Panels for the assembly of the side finishes.

Utilice cualquiera dos de los paneles 01 para montaje de los acabamientos laterales.

# INSTRUÇÕES

INSTRUCTIONS - INSTRUCCIONES

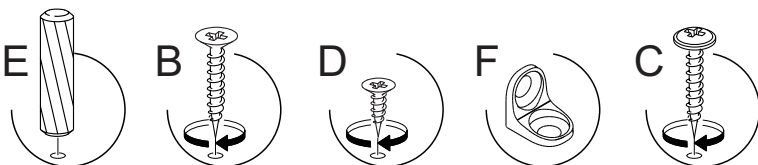

# MONTAGEM

ASSEMBLY - MONTAJE

*Caso tenha optado por um modelo com LED, siga o passo a seguir para completar as furações nos painéis externos.*

*If you have chosen a model with LED, follow the steps below to complete the holes in the external panels.*

*Si has elegido un modelo con LED, sigue los siguientes pasos para completar los agujeros en los paneles exteriores.*

**2**

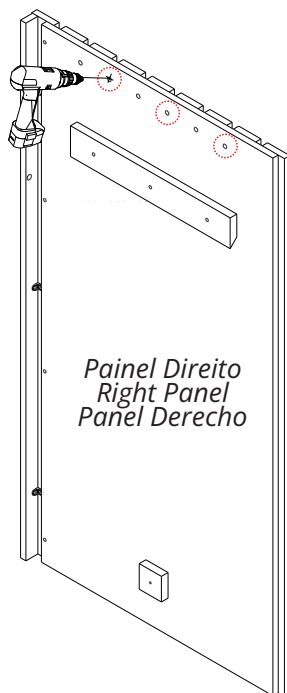
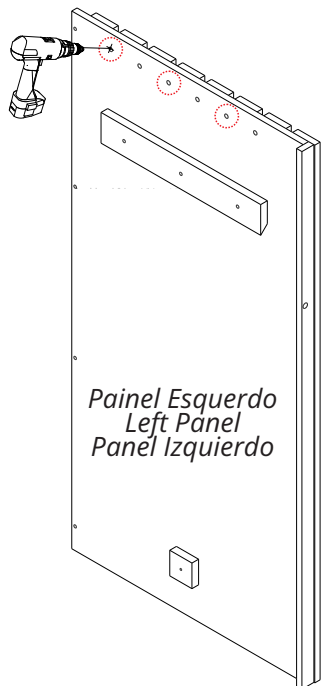

*Posicione as fitas de LED e o botão acionador, encaixe os difusores e faça a instalação conforme os passos descritos no manual anexo ao Kit LED.*

*Position the LED strips and the trigger button, fit the diffusers and carry out the installation according to the steps described in the instructions attached to the LED Kit.*

*Colocar las tiras LED y el pulsador disparador, colocar los difusores y realizar la instalación según los pasos descritos en el manual adjunto al Kit LED.*

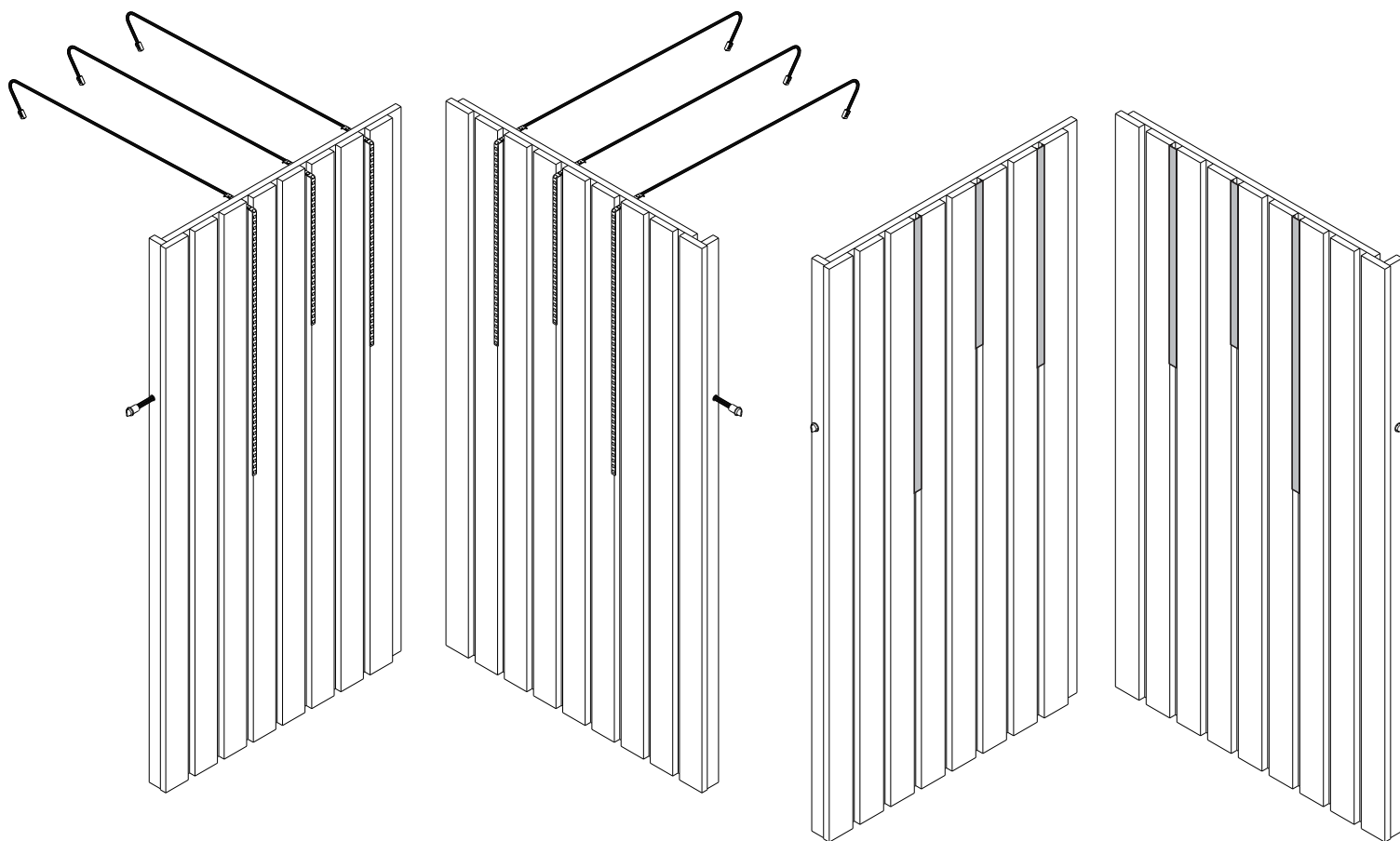

# MONTAGEM

ASSEMBLY - MONTAJE

## 2 PAINÉIS | 2 PANELS | 2 PANELES

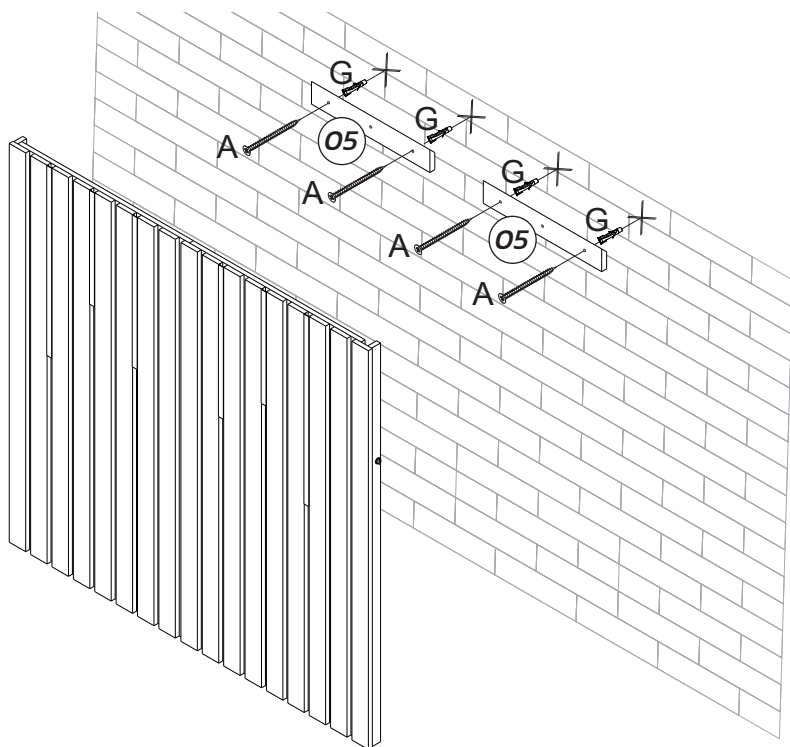

Cama Solteiro | Single Bed | Cama Individual

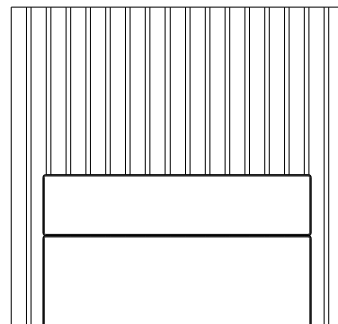

## 3 PAINÉIS | 3 PANELS | 3 PANELES

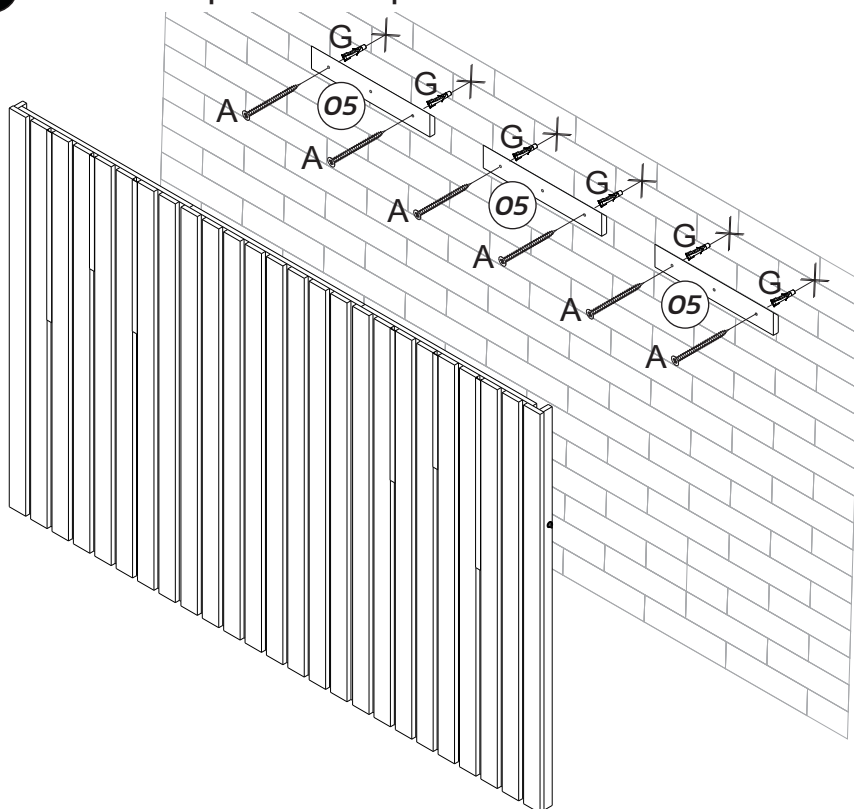

Cama Solteiro | Single Bed | Cama Individual  
1Mesa Cab. | 1Bedside Table | 1Mesilla de Noche

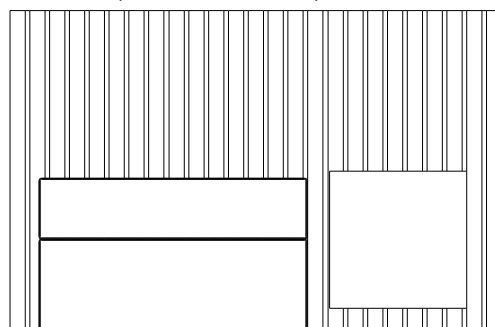

Cama Queen | Queen Bed | Cama Queen

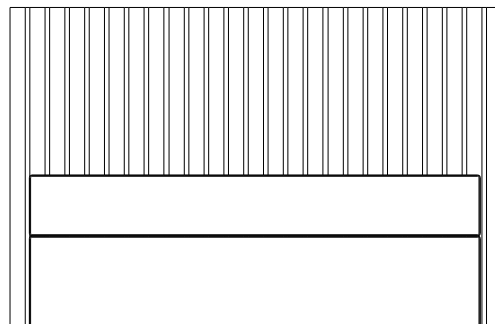

## INSTRUÇÕES

INSTRUCTIONS - INSTRUCCIONES

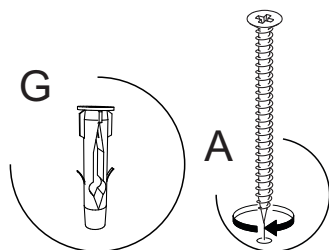

# MONTAGEM

ASSEMBLY - MONTAJE



4 PAINÉIS | 4 PANELS | 4 PANELES

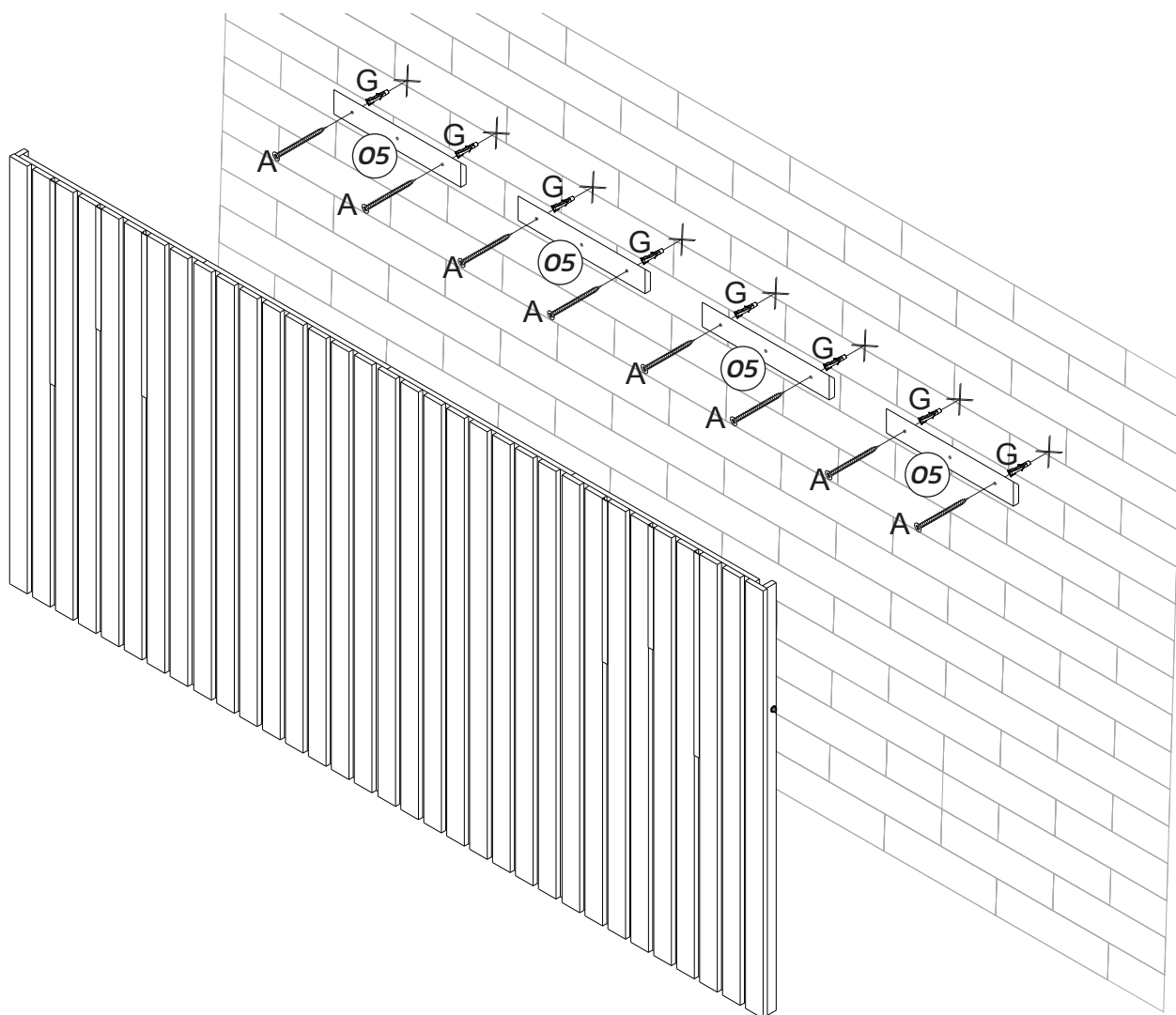

Cama Solteiro | Single Bed | Cama Individual  
2Mesa Cab. | 2Bedside Table | 2Mesilla de Noche

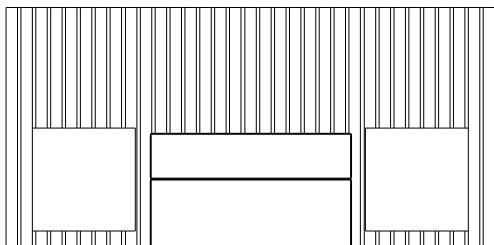

Cama Queen | Queen Bed | Cama Queen  
1Mesa Cab. | 1Bedside Table | 1Mesilla de Noche

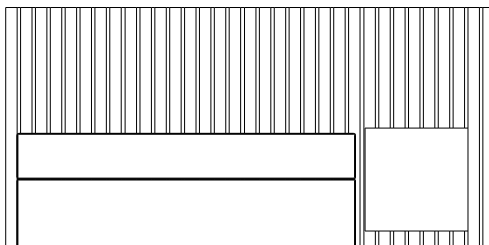

Cama King | King Bed | Cama King

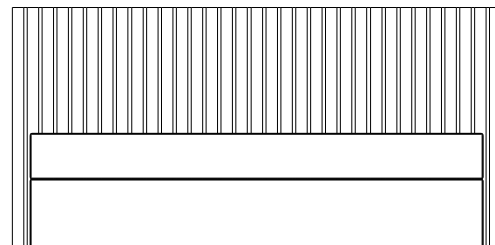

## INSTRUÇÕES

INSTRUCTIONS - INSTRUCCIONES

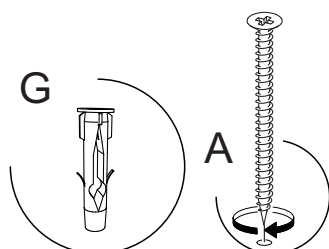

# MONTAGEM

ASSEMBLY - MONTAJE

● 5 PAINÉIS | 5 PANELS | 5 PANELES

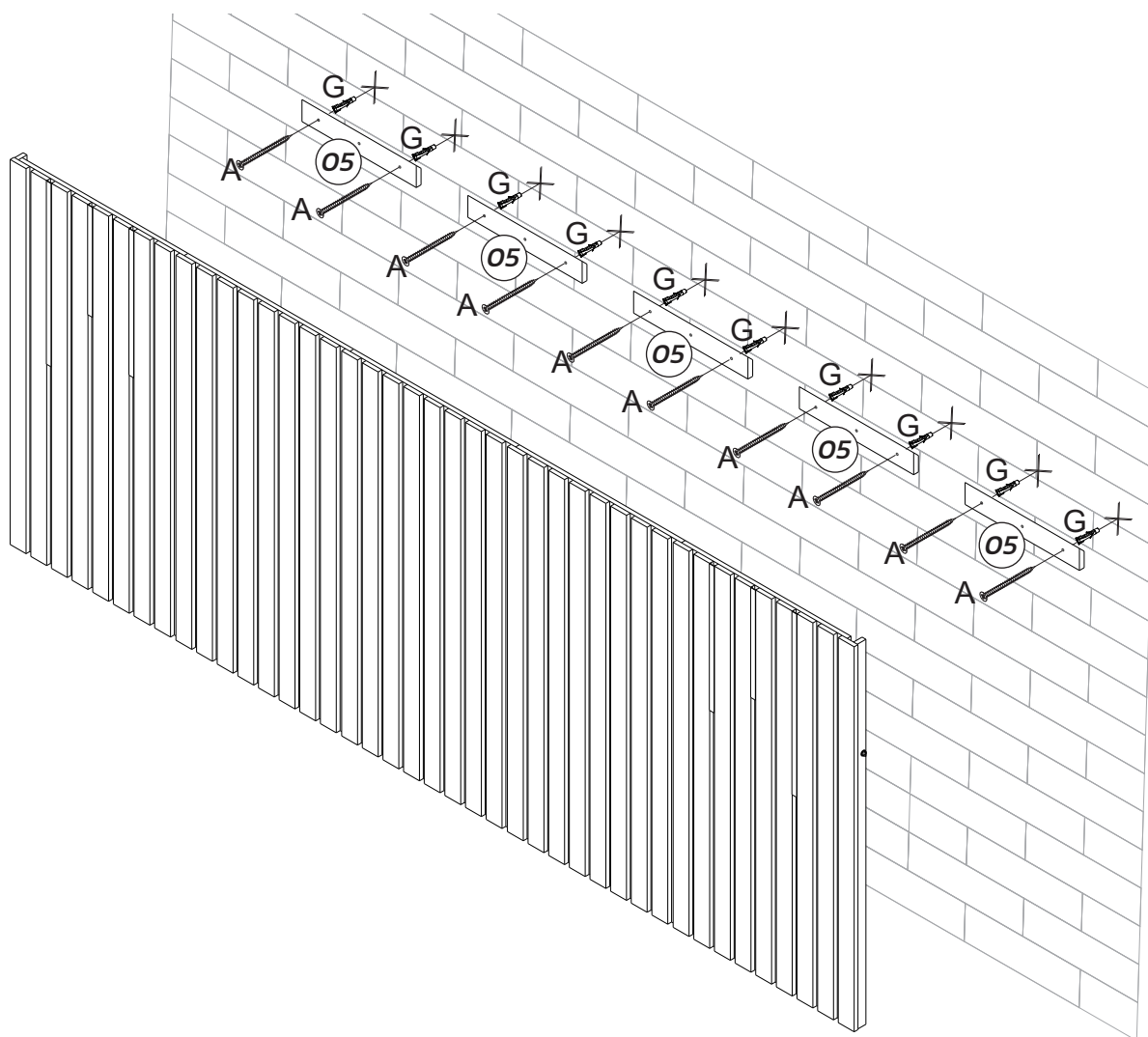

Cama Queen | Queen Bed | Cama Queen  
2Mesa Cab. | 2Bedside Table | 2Mesilla de Noche

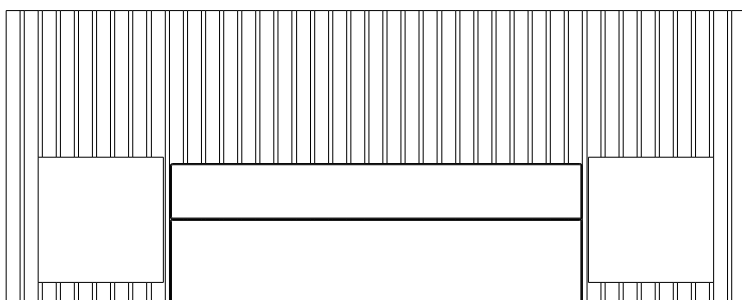

Cama King | Queen King | Cama King  
1Mesa Cab. | 1Bedside Table | 1Mesilla de Noche

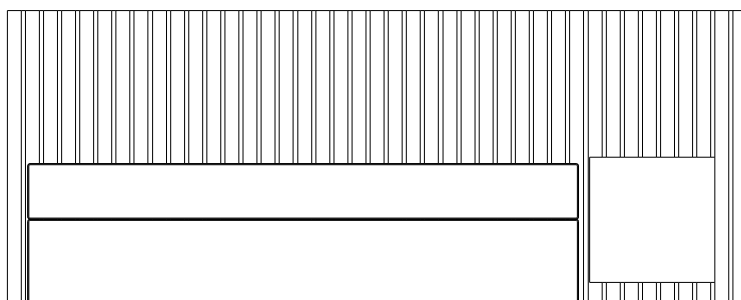

## INSTRUÇÕES

INSTRUCTIONS - INSTRUCCIONES

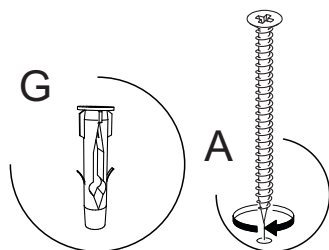



# MONTAGEM

ASSEMBLY - MONTAJE

● 6 PAINÉIS | 6 PANELS | 6 PANELES

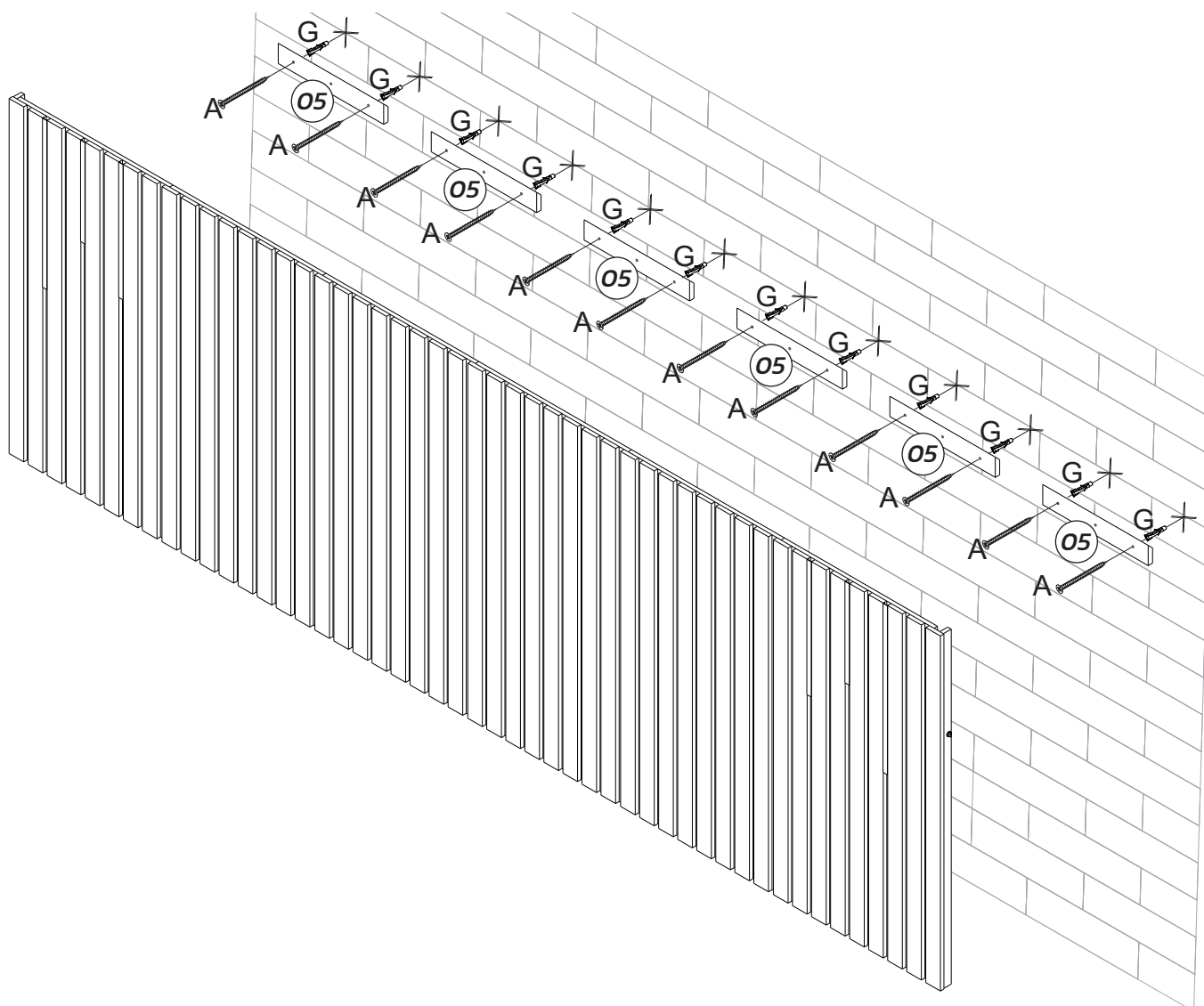

Cama King | Queen King | Cama King  
2Mesa Cab. | 2Bedside Table | 2Mesilla de Noche

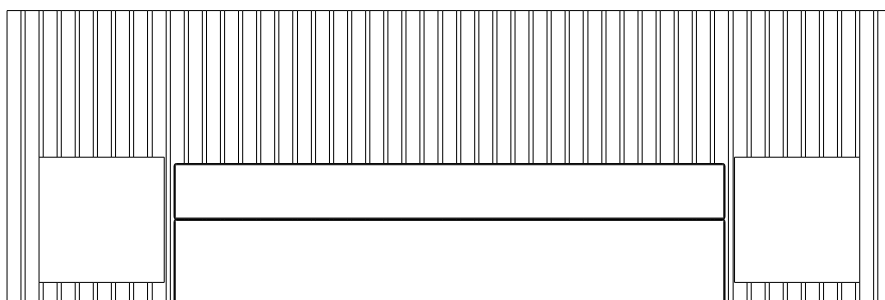

## INSTRUÇÕES

INSTRUCTIONS - INSTRUCCIONES

