

REFERÊNCIA DO MODELO
PH-1739 ROUPEIRO 2 PORTAS DE CORRER

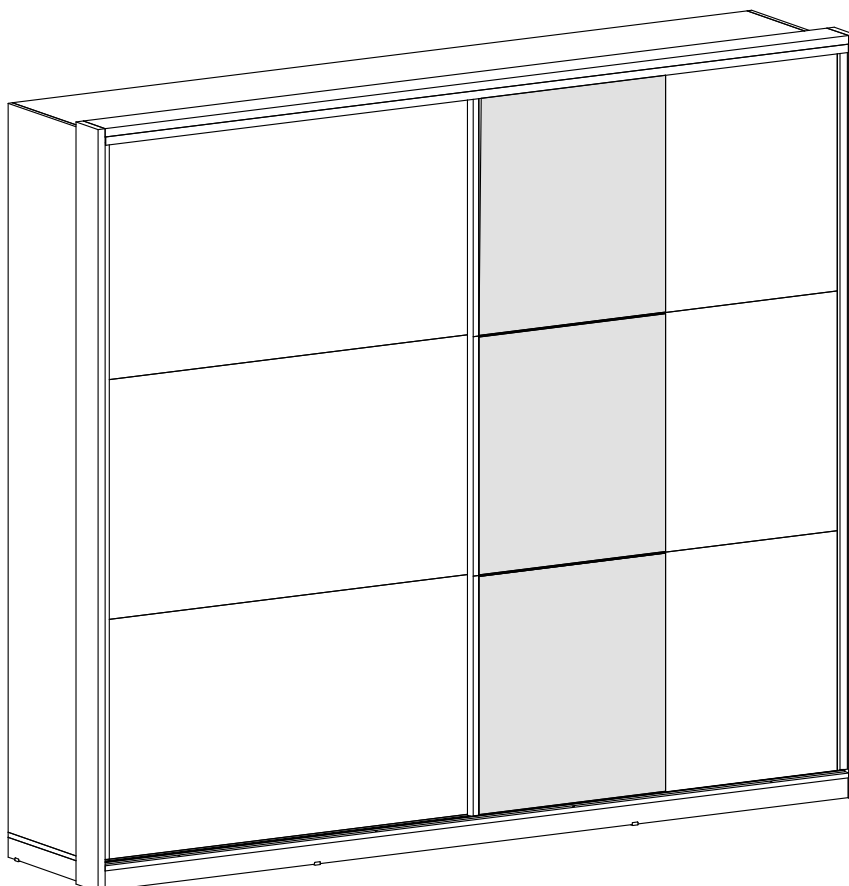

Montagem

Recomenda-se a leitura prévia das instruções de montagem e profissionais especializados para montar.

Assistência

Caso ocorra problema com alguns dos componentes, sublinhe o componente, identifique o problema e retorne esta relação imediatamente, via fax ou meio de comunicação disponível para o representante.

Assinatura do cliente

Informações ao cliente

Garantia de 06 meses, sendo 03 meses conforme o código de defesa do consumidor, e mais 03 meses por garantia do fabricante.

Nos reservamos no direito de efetuar alterações nos produtos, sem aviso prévio, quando entender necessário.



Atenção

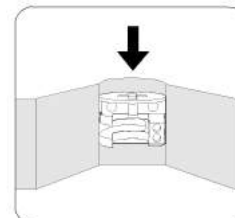
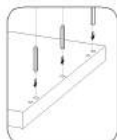

EXPLOÇÃO DAS PEÇAS

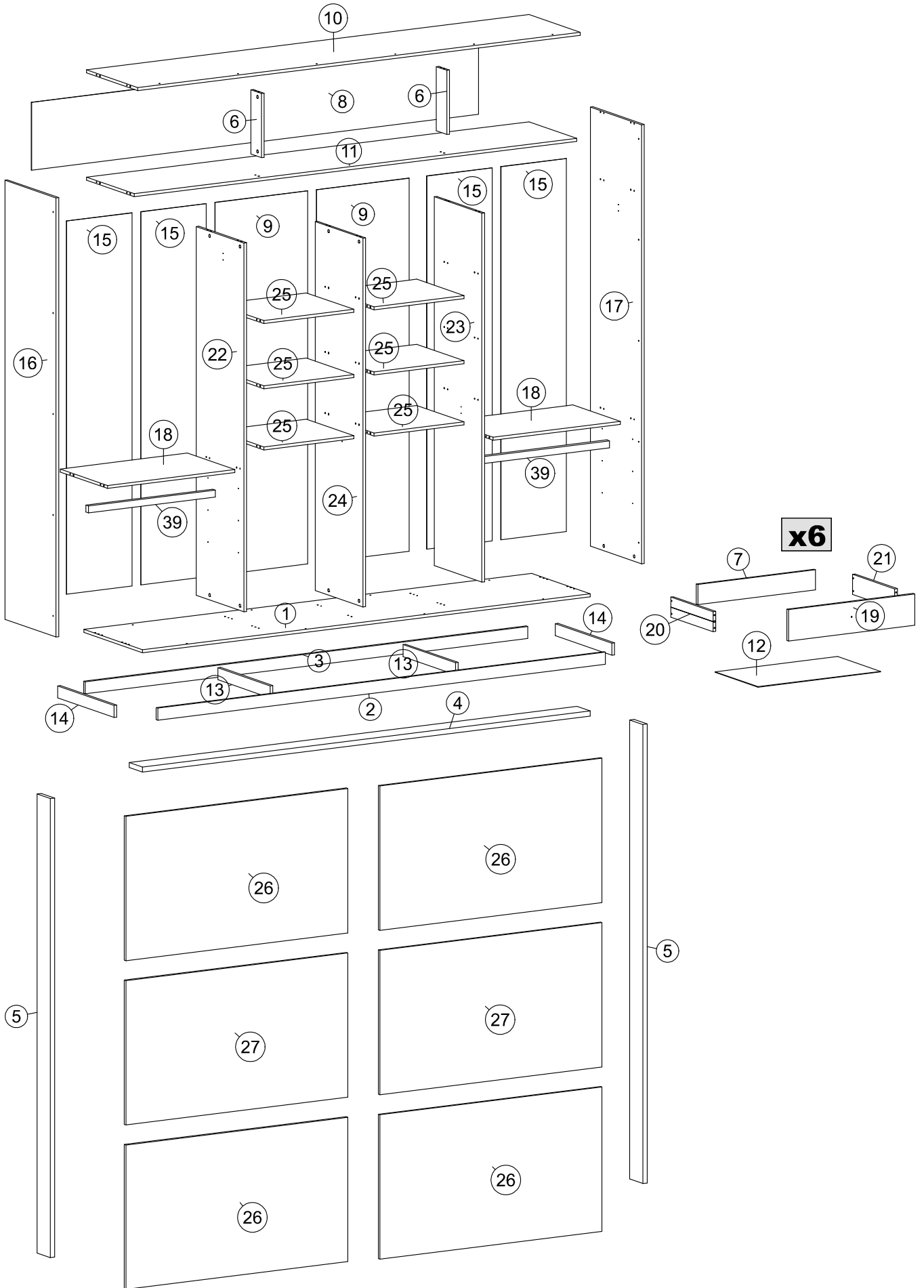

LISTA DE PEÇAS**VOLUME-1**

N°	CÓDIGO	PEÇA	MEDIDA	QTDE
1	158609E	BASE	2551.0x555.0x15.0	1
2	158610E	RODAPÉ FRONTAL	2551.0x60.0x15.0	1
3	158611E	RODAPÉ TRASEIRO	2521.0x60.0x15.0	1
4	158612E	VISTA SUPERIOR	2551.0x125.0x25.0	1
5	158613E	VISTA LATERAL	2290.0x125.0x25.0	2
6	158614L	TRAVESSA MALEIRO	320.0x100.0x15.0	2
7	158615L	TRASEIRO DE GAVETA	670.0x100.0x15.0	6
8	158616L	FUNDO SUPERIOR	2546.0x338.0x3.0	1
9	158617L	FUNDO	1861.0x527.0x3.0	2
28	1606858	SISTEMA DE CORRER JP360	xx	2
29	1607042	PUX DIAMANTE 26X19X11MM CHAMPAGNE	xx	6
30	1608466	PERFIL ALUMINIO SUPERIOR 2548MM	2548.0x59.0x25.0	1
31	1608468	PERF MET. CHAMPANHE	2160.0x18.1x10.2	2
32	1608469	PERFIL PUXADOR	2160.0x42.9x17.7	2
33	1608472	TUBO OBLONGO 715MM	715.0x30.0x15.8	2
34	1608473	TUBO OBLONGO 503MM	503.0x30.0x15.8	2
35	1602359	CORREDICA TELESCÓPICA SLIM 400MM	xx	6
36	1608467	PERFIL AL INF SG3061 2548MM C FURACAO	2548.0x42.0x5.2	1
39	158809E	SUPORTE GAVETEIRO	723.0x35.0x25.0	2
40	1608587	DESEMPENADOR MANCAL 2,00MTS 7118	xx	2
-	K072558	KIT ACESSÓRIOS	xx	1

VOLUME-2

N°	CÓDIGO	PEÇA	MEDIDA	QTDE
10	158618L	TAMPO	2521.0x485.0x15.0	1
11	158619L	MALEIRO	2521.0x452.0x15.0	1
12	158620L	FUNDO DE GAVETA	698.0x407.0x3.0	6
13	158628E	TRAVESSA RODAPÉ	497.0x60.0x15.0	2
14	158629E	RODAPÉ LATERAL	535.0x60.0x15.0	2
15	158621L	FUNDO MENOR	1861.0x372.0x3.0	4
37	1608471	PERFIL I 1840X20x3,8MM CINZA CIMENTO 053	1840.0x17.0x6.0	2

VOLUME-3

N°	CÓDIGO	PEÇA	MEDIDA	QTDE
16	158622L	LATERAL ESQUERDA	2190.0x485.0x15.0	1
17	158623L	LATERAL DIREITA	2190.0x485.0x15.0	1
18	158624L	TAMPO GAVETEIRO	725.0x450.0x15.0	2
19	158625L	FRENTE DE GAVETA	719.0x156.0x15.0	6
20	158626L	LATERAL GAV ESQ	400.0x100.0x15.0	6
21	158627L	LATERAL GAV DIR	400.0x100.0x15.0	6

VOLUME-4

N°	CÓDIGO	PEÇA	MEDIDA	QTDE
22	158630L	DIVISÃO ESQUERDA	1840.0x452.0x15.0	1
23	158631L	DIVISÃO DIREITA	1840.0x452.0x15.0	1
24	158632L	DIVISÃO CENTRAL	1840.0x452.0x15.0	1
25	158633L	PRATELEIRA FIXA	513.0x450.0x15.0	6

VOLUME-5

























N°	CÓDIGO	PEÇA	MEDIDA	QTDE
26	158644E	PORTA	1265.0x720.0x15.0	4
27	158643E	PORTA CENTRAL	1265.0x720.0x15.0	2

KIT ESPELHOS**CÓD.: 1203518**

N°	CÓDIGO	PEÇA	MEDIDA	QTDE
38	-	ESPELHO 3MM	715x640x3mm	3

KIT ACESSÓRIOS

CÓD.: K072558





INDICE	PEÇA	IMAGEM	CÓDIGO	QTDE
A	CANTONEIRA 18x18 (ZA)		1604580	8
B	CANTONEIRA SUPORTE TRIANGULAR COM ABA		-	6
C	CAVILHA DE MADEIRA 6X40		1604742	68
D	CAVILHA DE MADEIRA 6X70		1606280	8
E	HASTE COM ANEL 61.4MM (09.02.003)		1607855	8
F	FIXADOR PARA COSTAS ZINCO BR		1601469	47
G	PARAFUSO 3 X 20 CAB. CHATA PHILIPS		1604857	66
G1	GIZ CERA NOG-CEDRO-FENDI-FREIJÓ Ø14x8MM		XXXXXXXX	1
G4	GIZ CERA OFF WHITE - CINZA BP - LÍNEO Ø14x8MM		XXXXXXXX	1
G5	GIZ CERA CARVALHO VERMONT Ø14x8MM		XXXXXXXX	1
H	PARAFUSO 3.5 X 16 CAB. CHATA PHILIPS		1606855	6
I	PARAFUSO 4 X 45 CAB. FLANGEADO		4x45	8
J	PARAFUSO 4 X 14 CAB. CHATA REBAIXADA PHILIPS		1602420	104
K	PARAFUSO 4 X 35 CAB. CHATA PHILIPS		1606636	16
L	PARAFUSO MINIFIX DU255		1602006	56
M	PARAFUSO 4 X 40 CAB. CHATA PHILIPS		1604937	40
N	PREGO 10 X 10 C/CABEÇA - Ø1,5 x 23mm		1605365	147
O	SAPATA QUADRADA 15x15mm (CINZA)		1602714	8
P	SUPORTE (04 04 059)		-	16
Q	SUPORTE TUBO OBLONGO PLÁSTICO		1603790	8
R	TAMBOR MINIFIX Ø14.9X11MM		1605358	72
S	TAPA FURO ADESIVO PAPEL 22MM LÍNEO		1607531	42
T	PARAFUSO 3.5 X 14 CAB. CHATA PHILIPS		1607861	74
U	PARAFUSO 3.5 X 30 CAB. CHATA PHILIPS		1602836	6

PASSO 1

PEÇAS NECESSÁRIAS

INDICE	QUANT.
16	1
17	1
35	6

FERRAGEM NECESSÁRIA

QTDE	IMAGEM	INDICE
4		C
16		J
12		L
2		Q

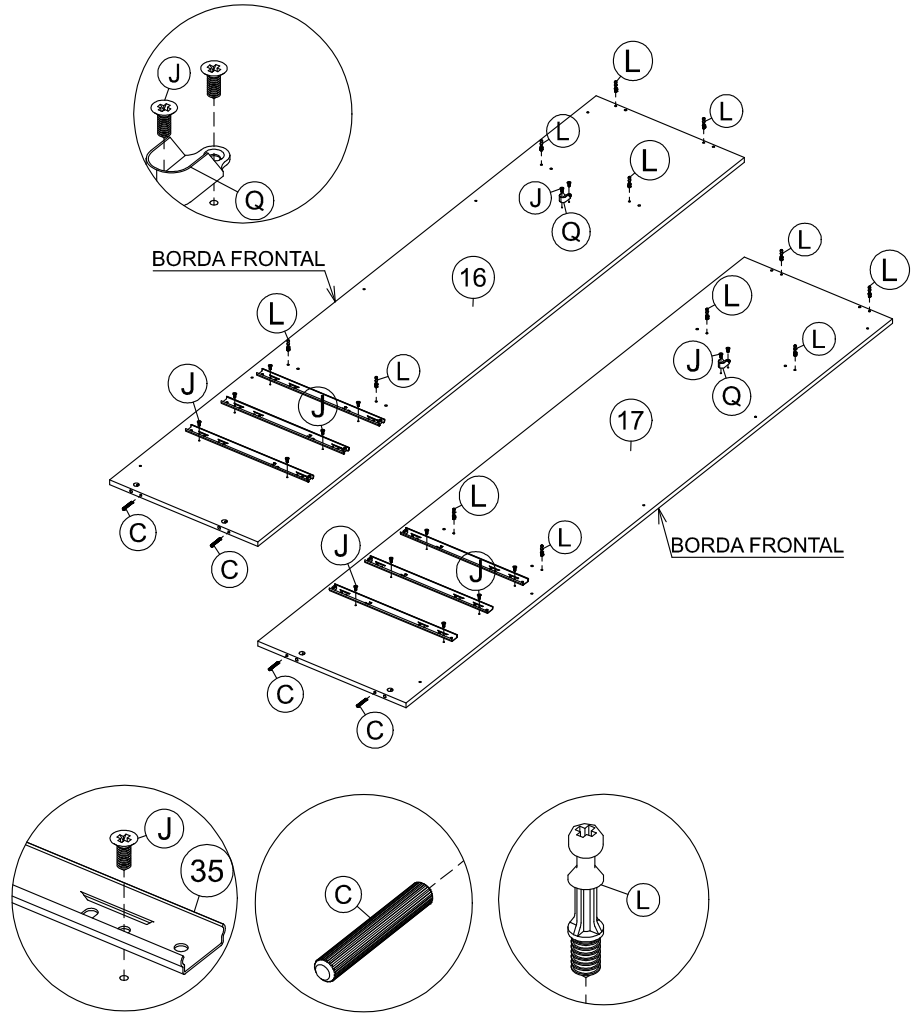





PASSO 2

PEÇAS NECESSÁRIAS

INDICE	QUANT.
22	1
23	1
24	1

FERRAGEM NECESSÁRIA

QTDE	IMAGEM	INDICE
10		C
6		J
12		M
3		Q

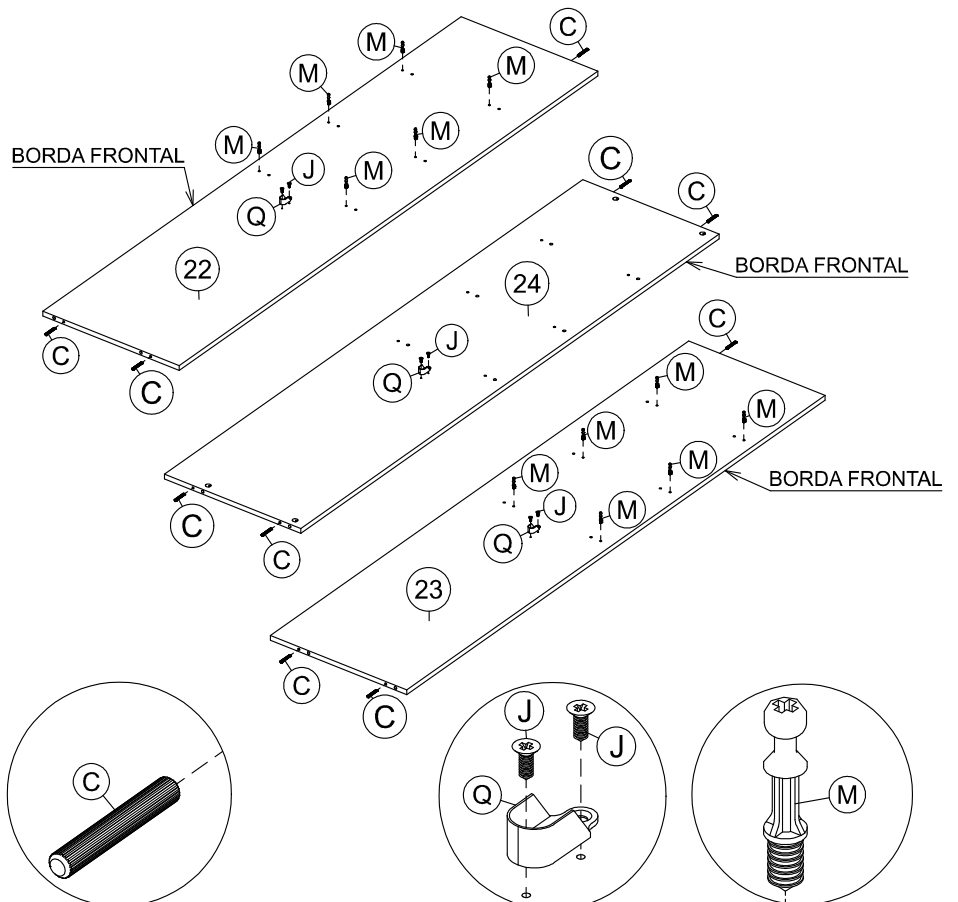



PASSO 3

PEÇAS NECESSÁRIAS

INDICE	QUANT.
22	1
23	1
24	1
35	6

FERRAGEM NECESSÁRIA

QTDE	IMAGEM	INDICE
18		J
3		Q

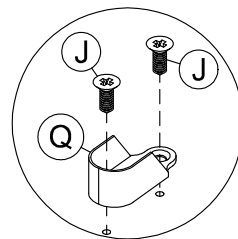
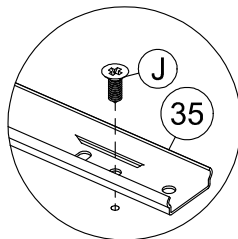
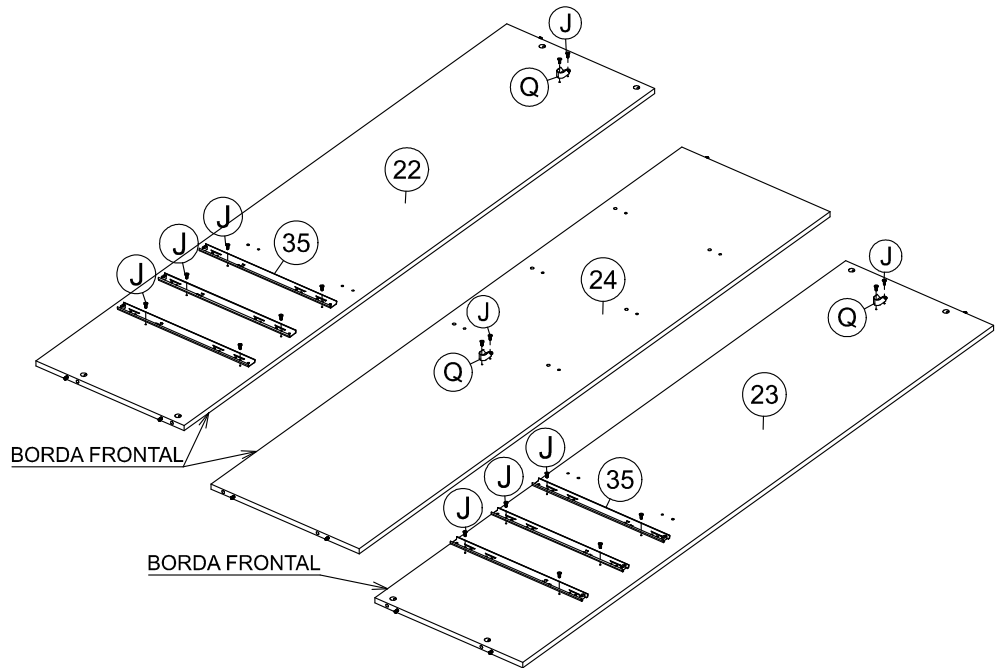



PASSO 4

PEÇAS NECESSÁRIAS

INDICE	QUANT.
1	1
10	1
11	1

FERRAGEM NECESSÁRIA

QTDE	IMAGEM	INDICE
8		C
16		L

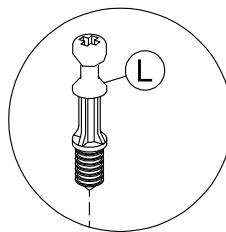
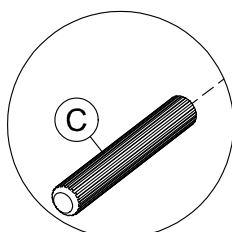
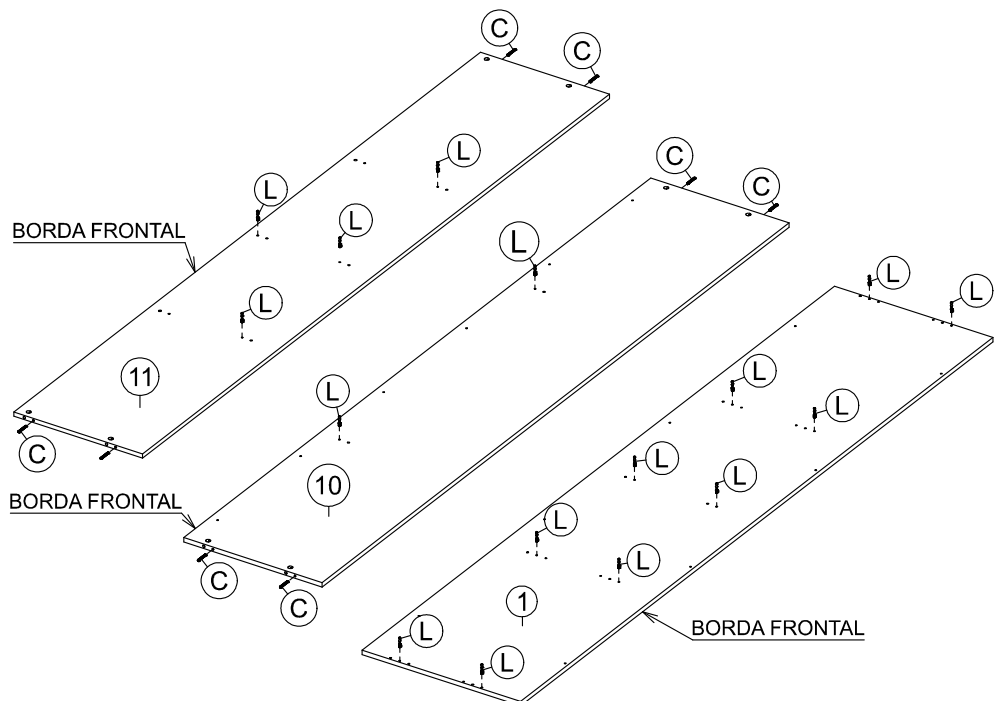



PASSO 5

PEÇAS NECESSÁRIAS

INDICE	QUANT.
6	1
18	2
25	6

FERRAGEM NECESSÁRIA

QTDE	IMAGEM	INDICE
22		C
8		D

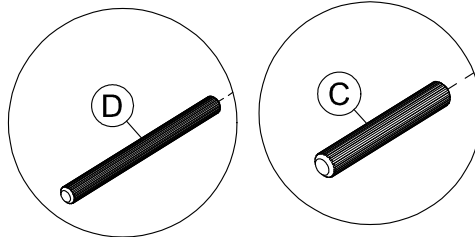
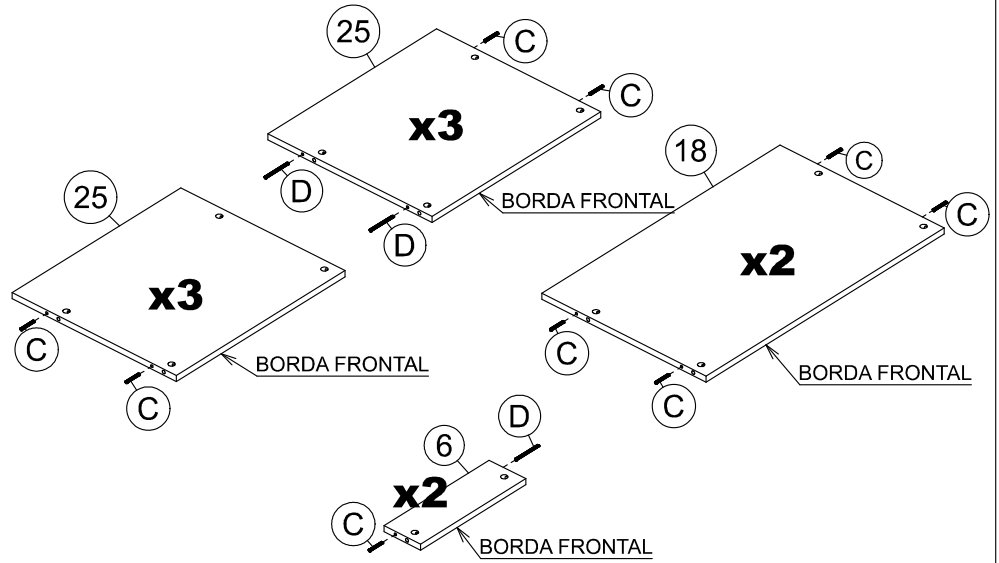





PASSO 6

PEÇAS NECESSÁRIAS

INDICE	QUANT.
2	1
3	1
13	2

FERRAGEM NECESSÁRIA

QTDE	IMAGEM	INDICE
4		A
8		J
4		N
4		O

Atenção na montagem dos Rodapés, pois o Rodapé Traseiro (3) é menor que o Rodapé Frontal (2).

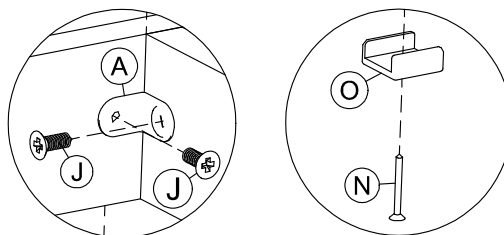
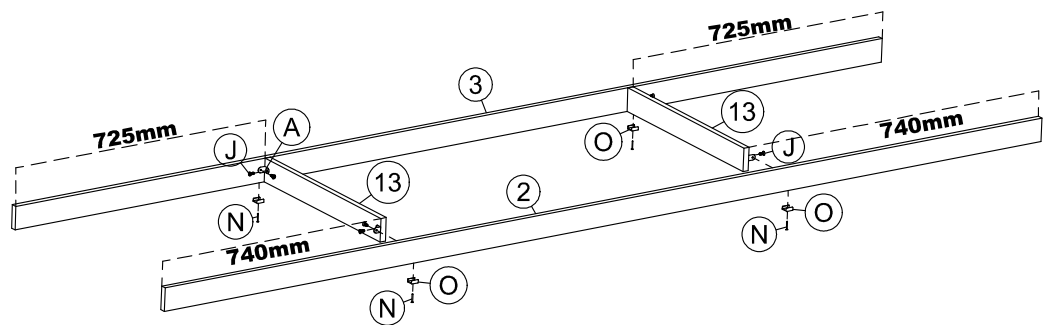

PASSO 7

PEÇAS NECESSÁRIAS

INDICE	QUANT.
14	2

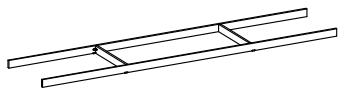

FERRAGEM NECESSÁRIA

QTDE	IMAGEM	INDICE
4		A
8		J
4		N
4		O

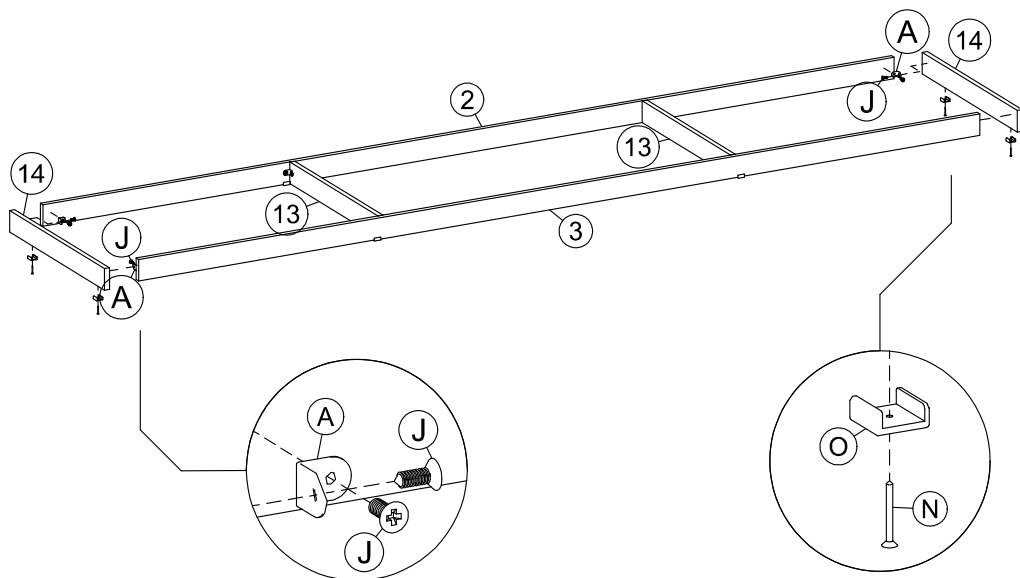

PASSO-7 MONTADO

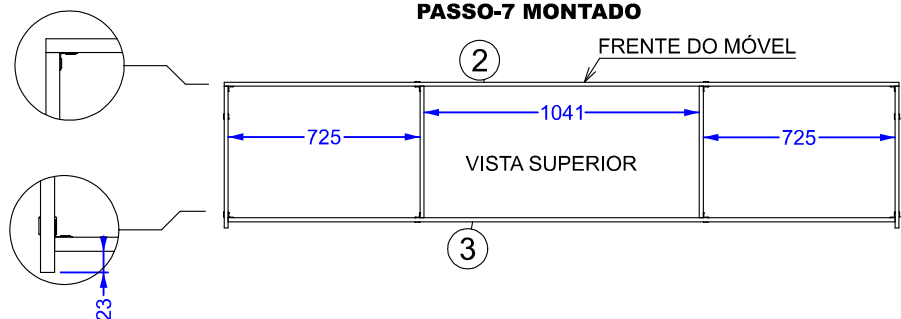

PASSO 8

PEÇAS NECESSÁRIAS

INDICE	QUANT.
1	1

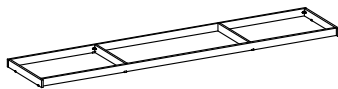

FERRAGEM NECESSÁRIA

QTDE	IMAGEM	INDICE
12		M

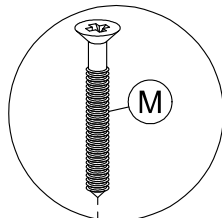
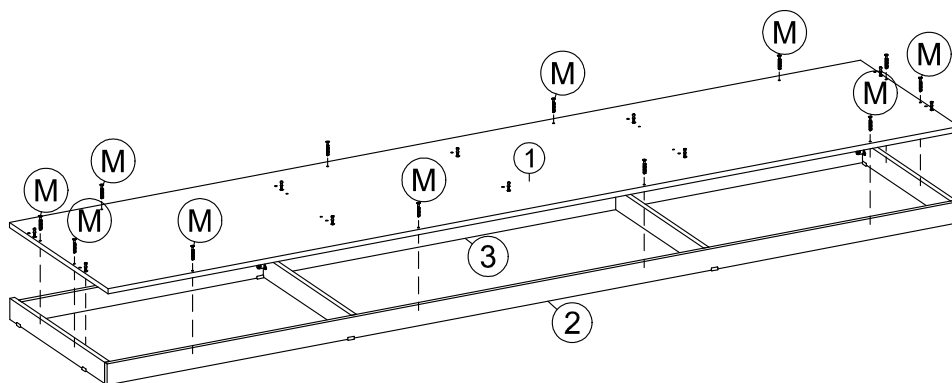



PASSO 9

PEÇAS NECESSÁRIAS

INDICE	QUANT.
22	1
24	1
25	3

FERRAGEM NECESSÁRIA

QTDE	IMAGEM	INDICE
6		E
12		R

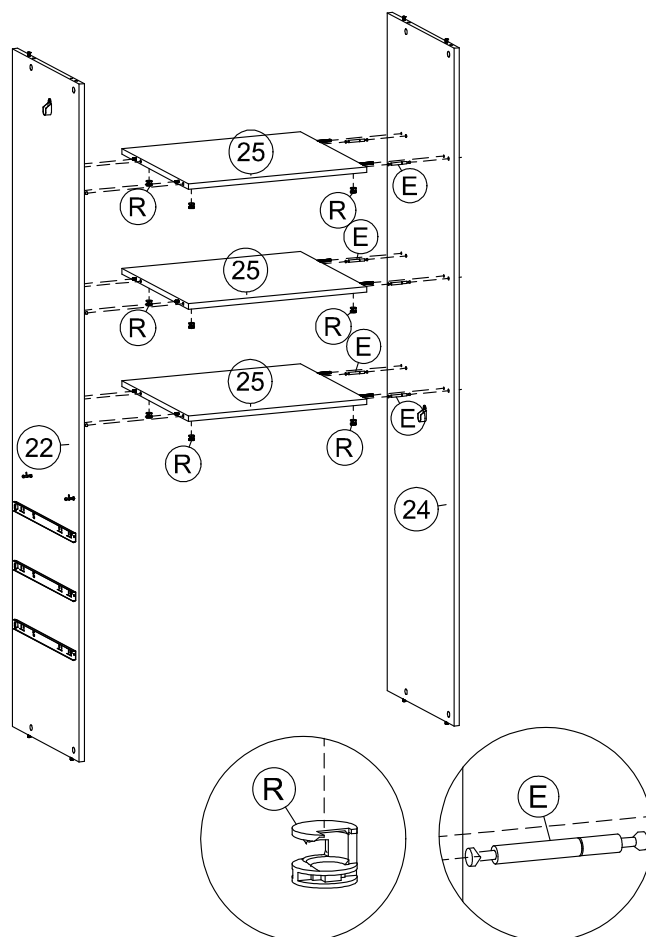

PASSO 10

PEÇAS NECESSÁRIAS

INDICE	QUANT.
23	1
25	3

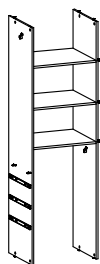

FERRAGEM NECESSÁRIA

QTDE	IMAGEM	INDICE
12		R

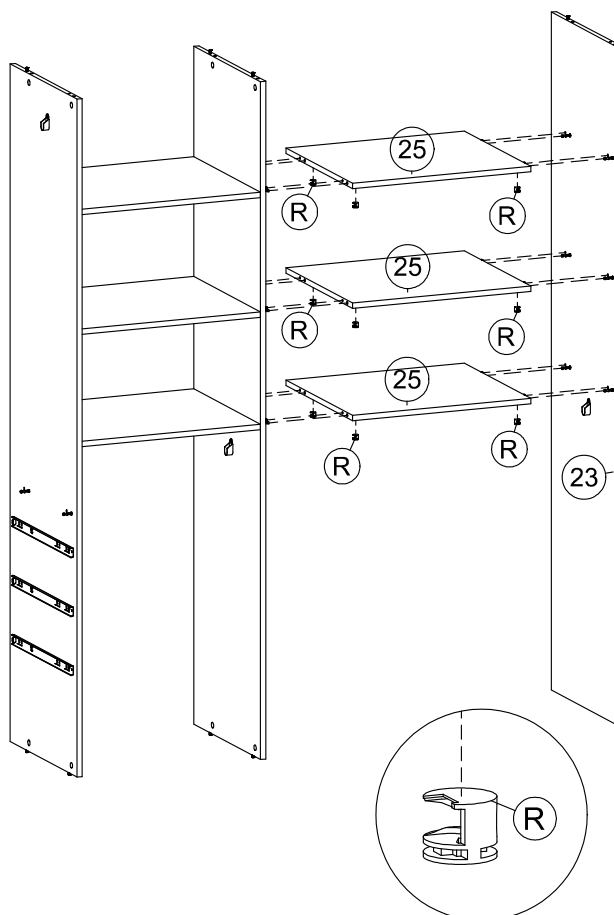

PASSO 11

PEÇAS NECESSÁRIAS

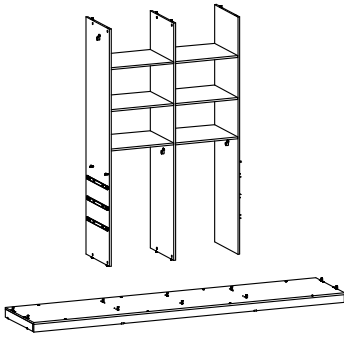

FERRAGEM NECESSÁRIA

QTDE	IMAGEM	INDICE
6		R

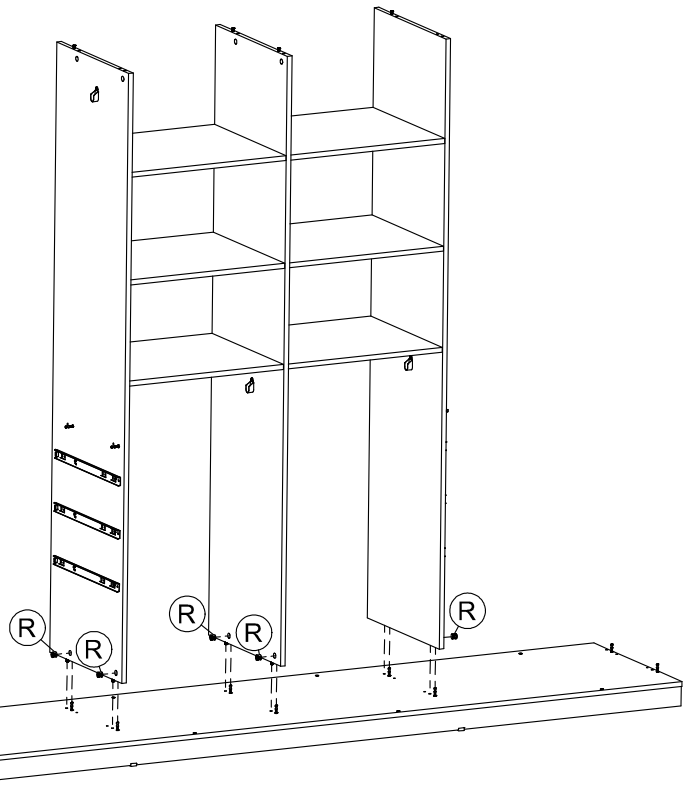
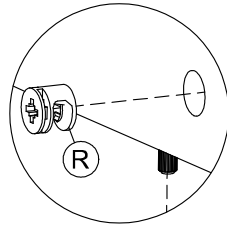

PASSO 12

PEÇAS NECESSÁRIAS

INDICE	QUANT.
11	1

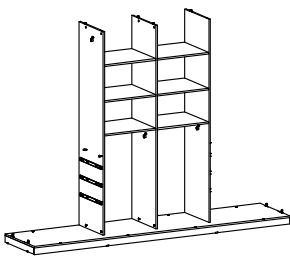

FERRAGEM NECESSÁRIA

QTDE	IMAGEM	INDICE
2		E
6		R

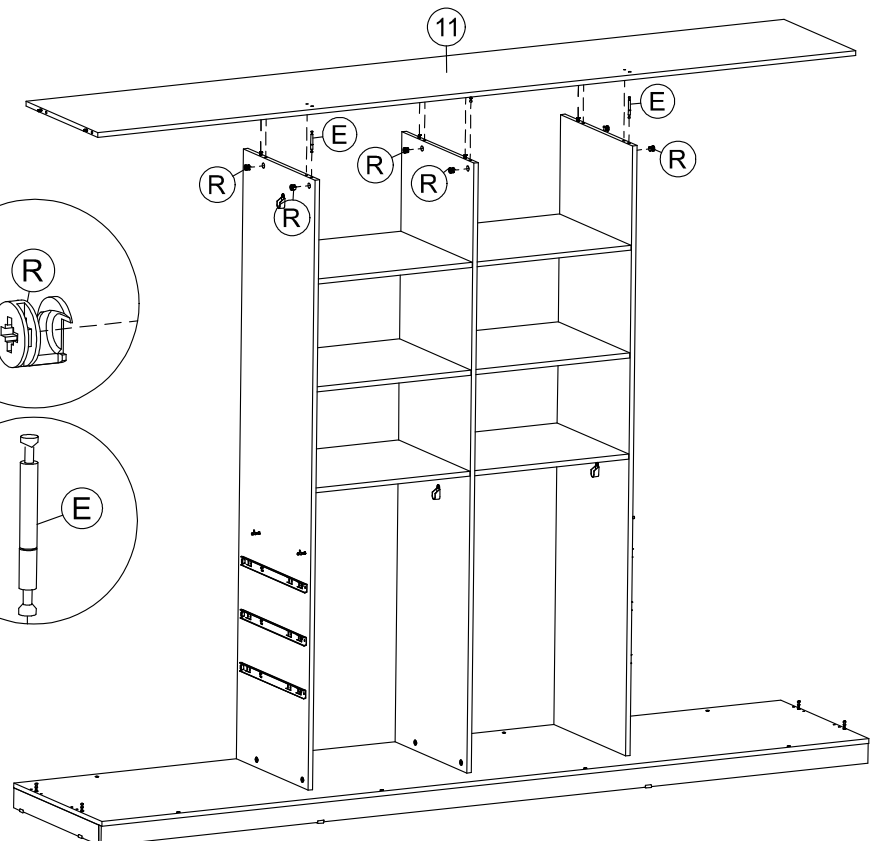
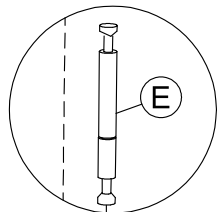
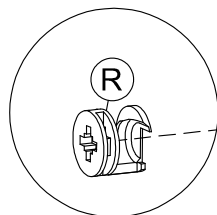

PASSO 13

PEÇAS NECESSÁRIAS

INDICE	QUANT.
16	1
18	1

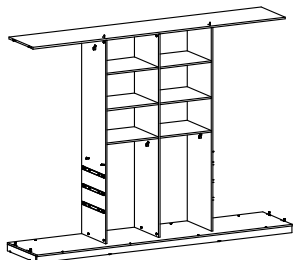

FERRAGEM NECESSÁRIA

QTDE	IMAGEM	INDICE
8		R

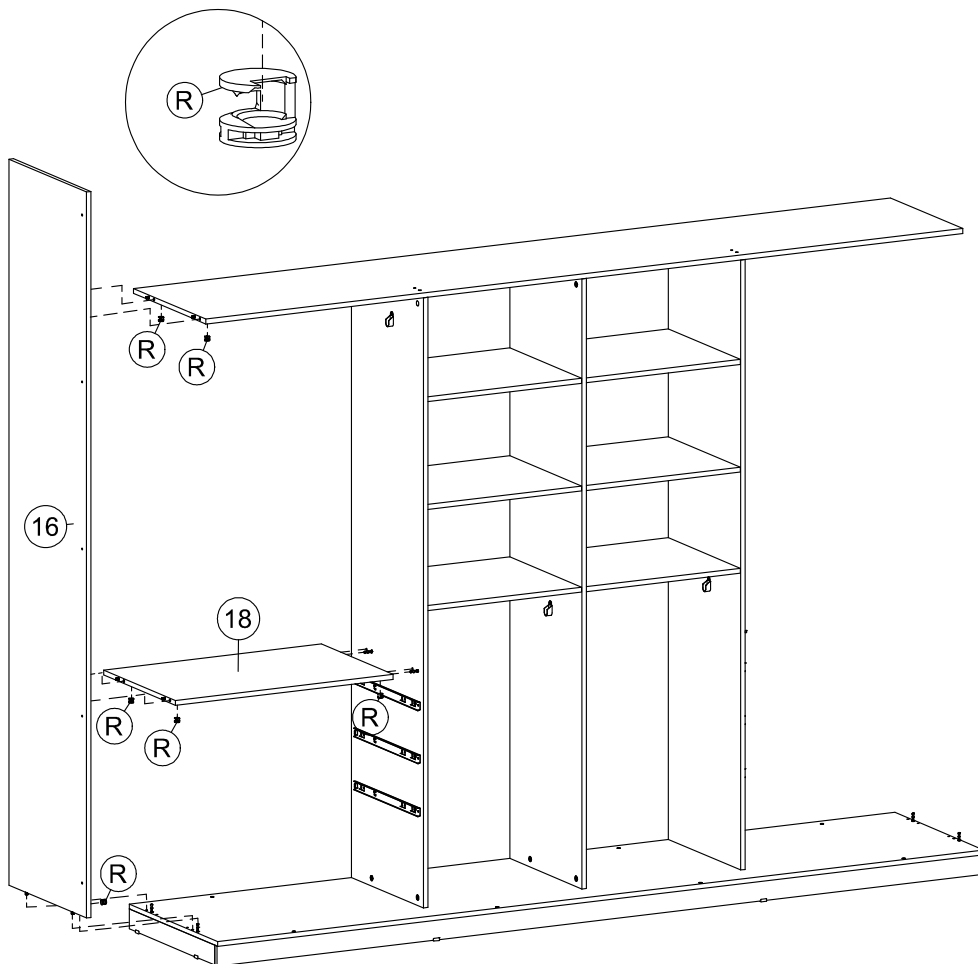

PASSO 14

PEÇAS NECESSÁRIAS

INDICE	QUANT.
6	2
17	1
18	1

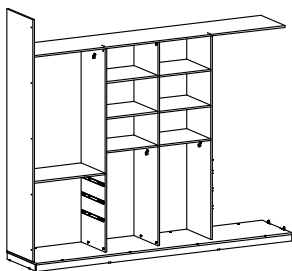

FERRAGEM NECESSÁRIA

QTDE	IMAGEM	INDICE
8		R

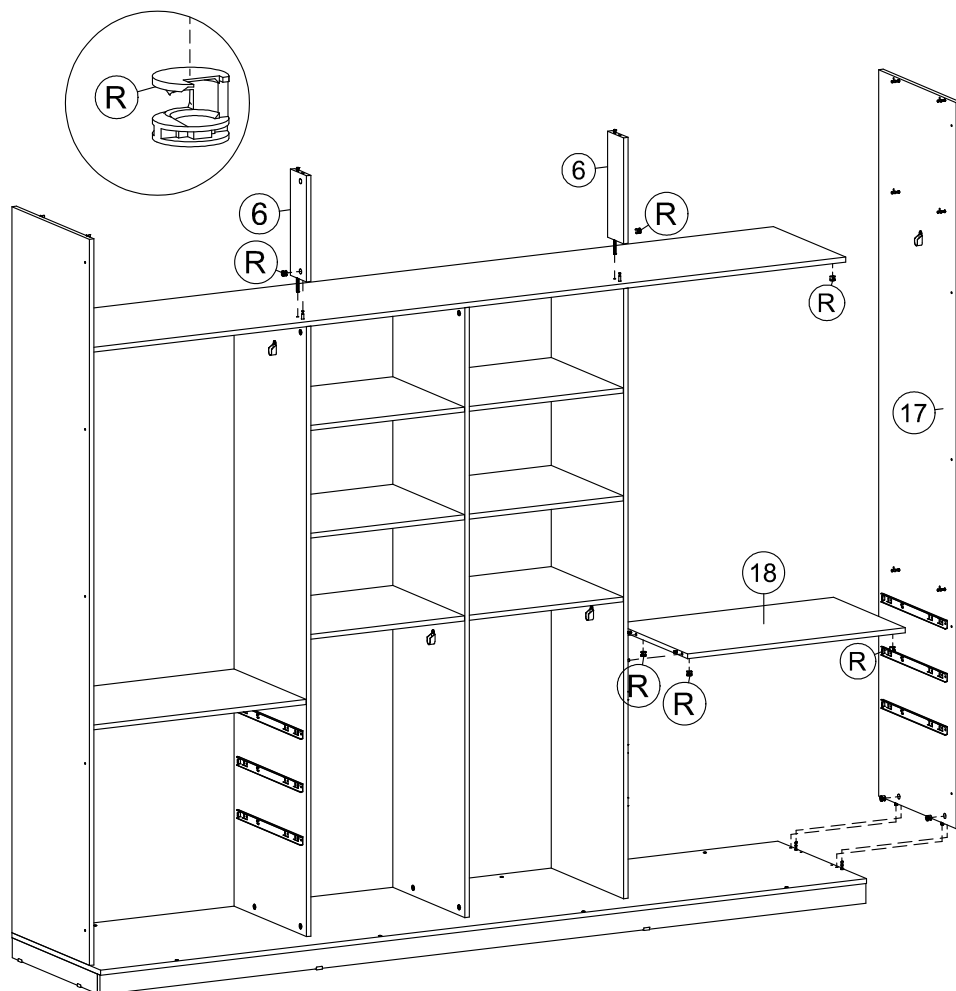

PASSO 15

PEÇAS NECESSÁRIAS

INDICE	QUANT.
10	1
39	2

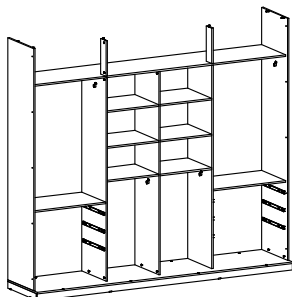

FERRAGEM NECESSÁRIA

QTDE	IMAGEM	INDICE
8		I
6		R

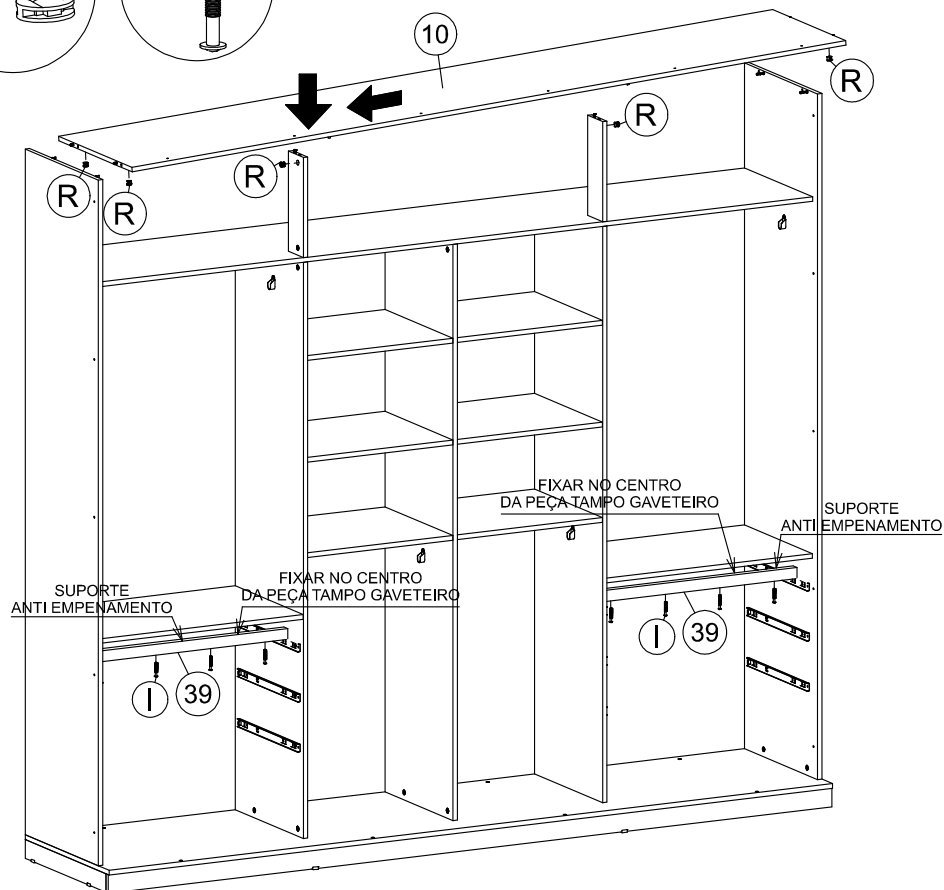
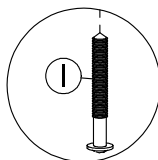
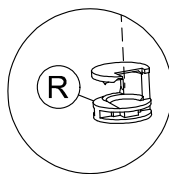

PASSO 16

PEÇAS NECESSÁRIAS

INDICE	QUANT.
8	1
9	2
15	4
37	2

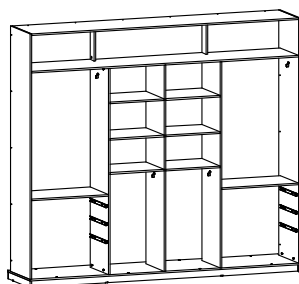

FERRAGEM NECESSÁRIA

QTDE	IMAGEM	INDICE
47		F
111		N

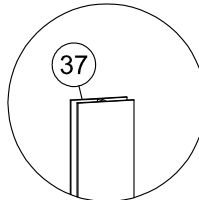
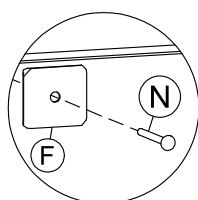

Atenção

Deixar o móvel no esquadro antes de iniciar a fixação dos Fundos (15,9,8)

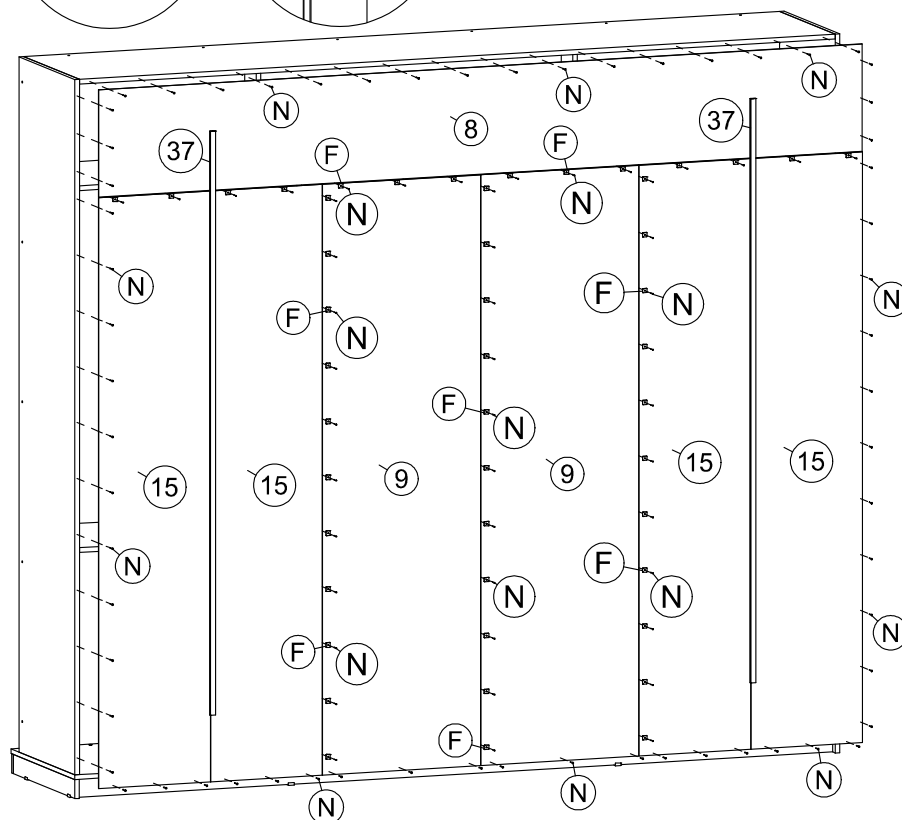

PASSO 17

PEÇAS NECESSÁRIAS

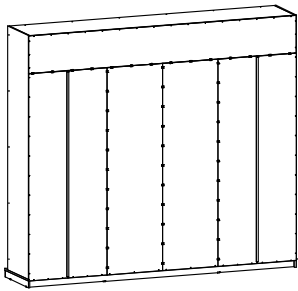

FERRAGEM NECESSÁRIA

QTDE	IMAGEM	INDICE
30		N

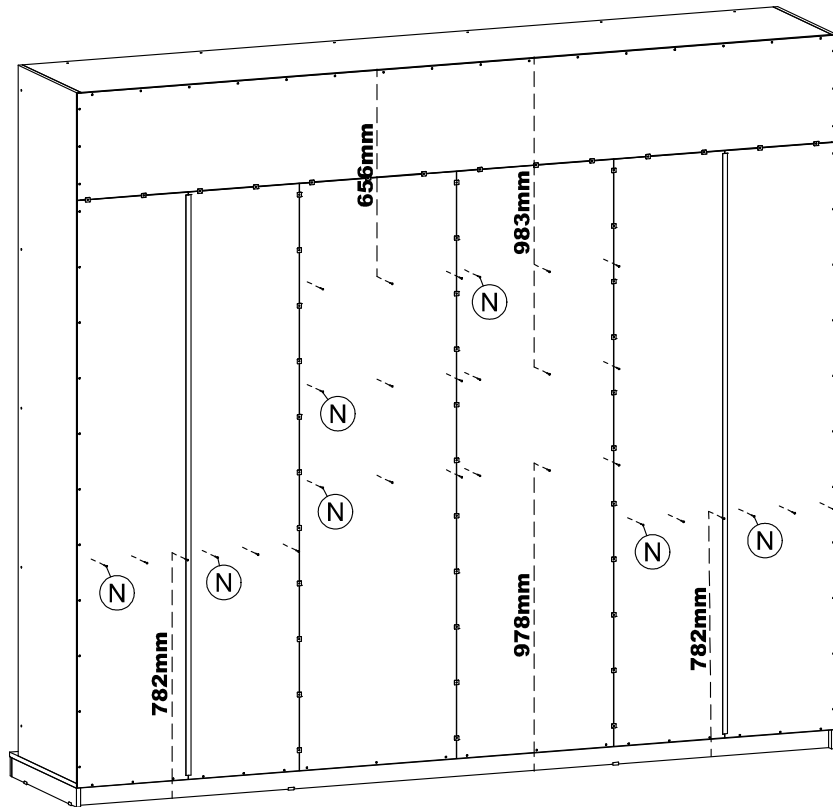
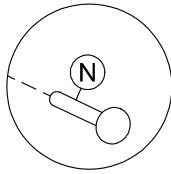

PASSO 18

PEÇAS NECESSÁRIAS PARTS REQUIRED

INDICE	QUANT.
4	1
5	2

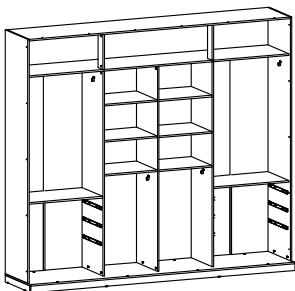

FERRAGEM NECESSÁRIA

QTDE	IMAGEM	INDICE
16		K

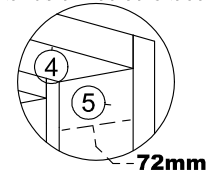
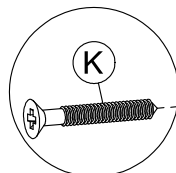

Fixar as Vistas Laterais e Superior
respeitando a medida citada abaixo.

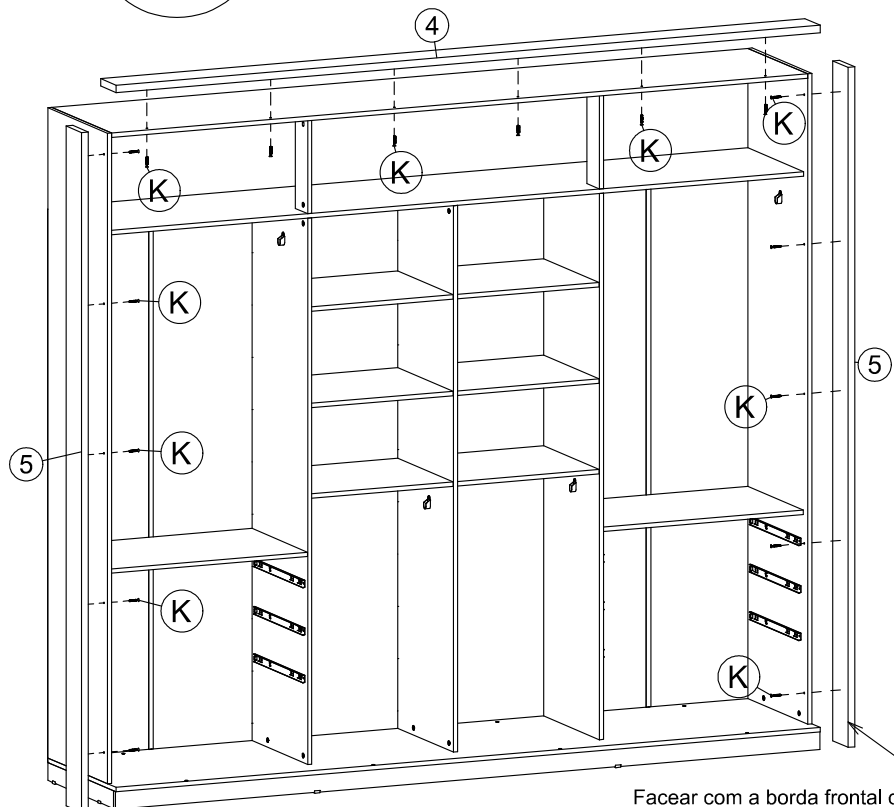

Facear com a borda frontal da Base.

PASSO 19

PEÇAS NECESSÁRIAS

INDICE	QUANT.
30	1
36	1

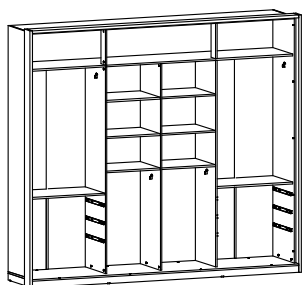

FERRAGEM NECESSÁRIA

QTDE	IMAGEM	INDICE
18		J
28		S

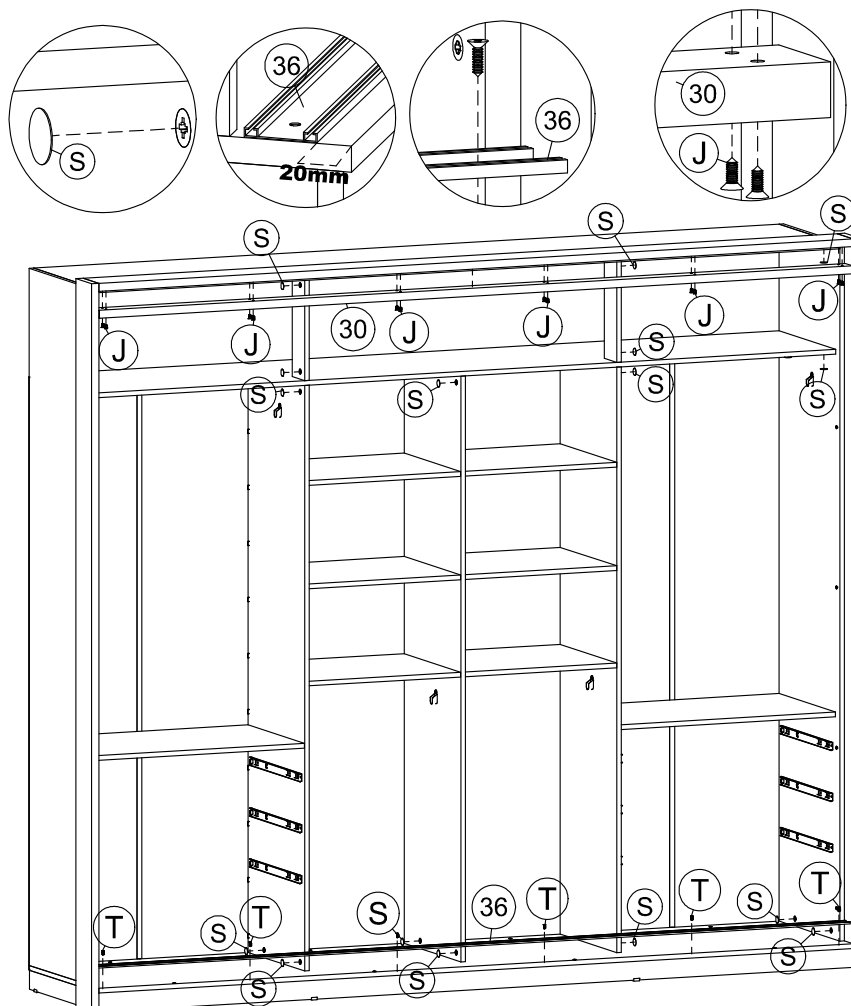

PASSO 20

PEÇAS NECESSÁRIAS

INDICE	QUANT.
19	6
20	6
21	6

FERRAGEM NECESSÁRIA

QTDE	IMAGEM	INDICE
24		C
12		L

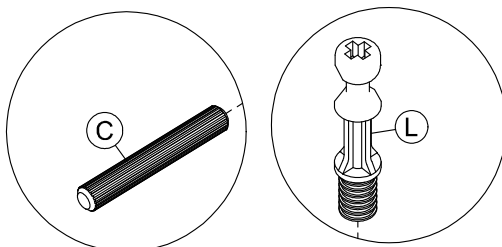
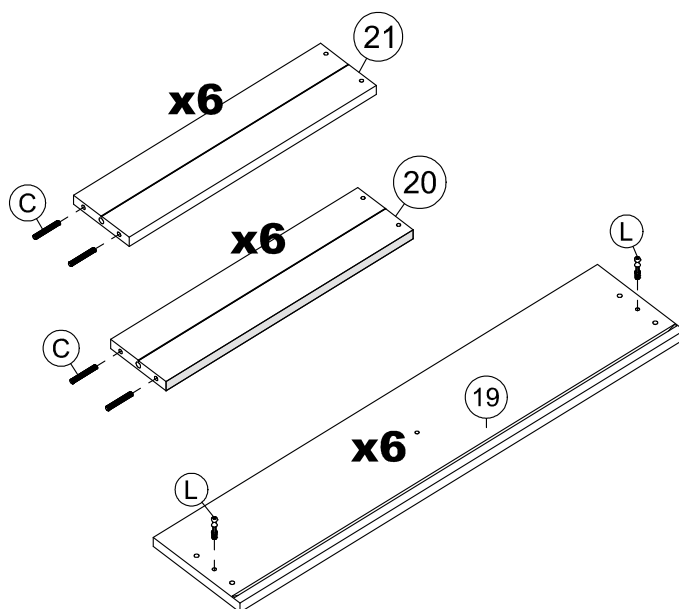



PASSO 21

PEÇAS NECESSÁRIAS

INDICE	QUANT.
7	6
19	6
20	6
21	6

FERRAGEM NECESSÁRIA

QTDE	IMAGEM	INDICE
24		M
12		R
12		S

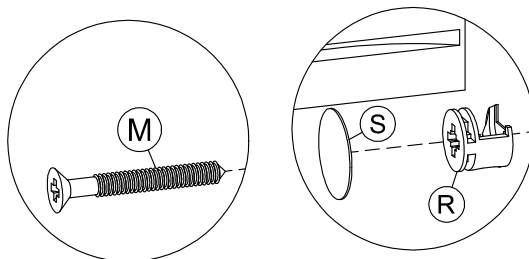
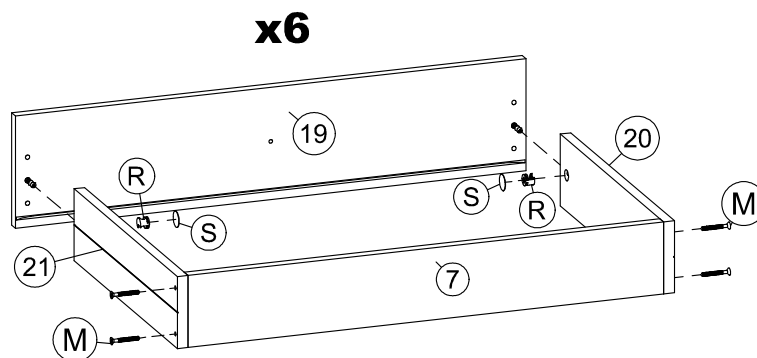



PASSO 22

PEÇAS NECESSÁRIAS

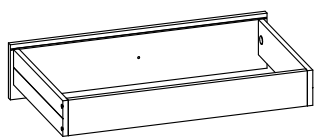
INDICE	QUANT.
12	6



FERRAGEM NECESSÁRIA

QTDE	IMAGEM	INDICE
6		B
66		G
6		H

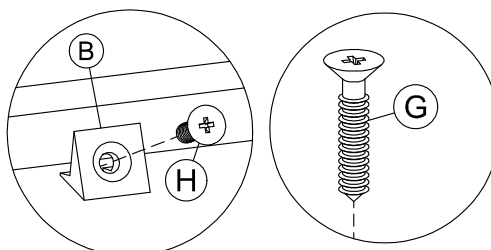
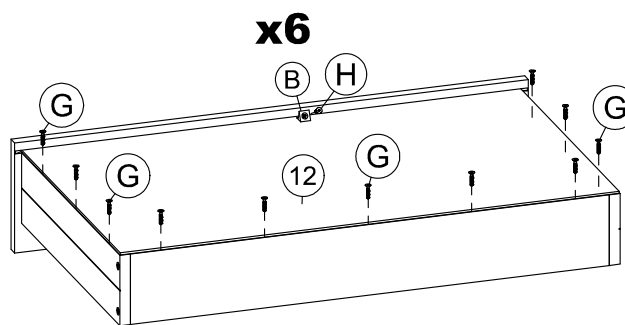

PASSO 23

PEÇAS NECESSÁRIAS

INDICE	QUANT.
29	6
35	12

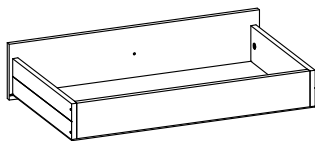

FERRAGEM NECESSÁRIA

QTDE	IMAGEM	INDICE
36		J
6		U

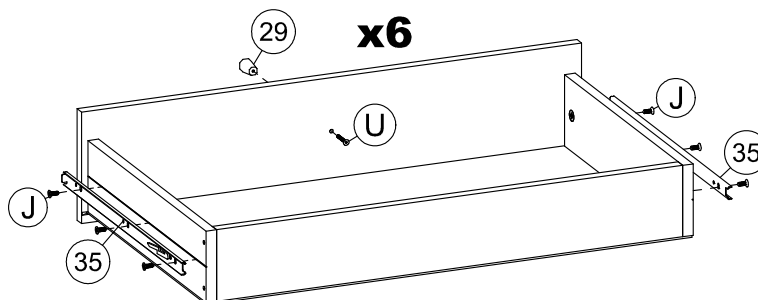

Fixar Corrediças na ranhura da lateral de gaveta.

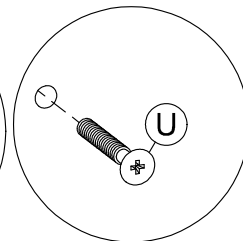
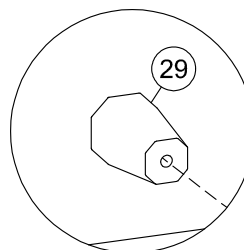
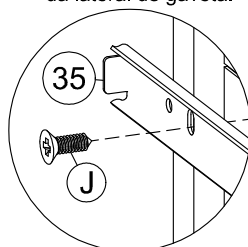

PASSO 24

PEÇAS NECESSÁRIAS

INDICE	QUANT.
33	2
34	2

FERRAGEM NECESSÁRIA

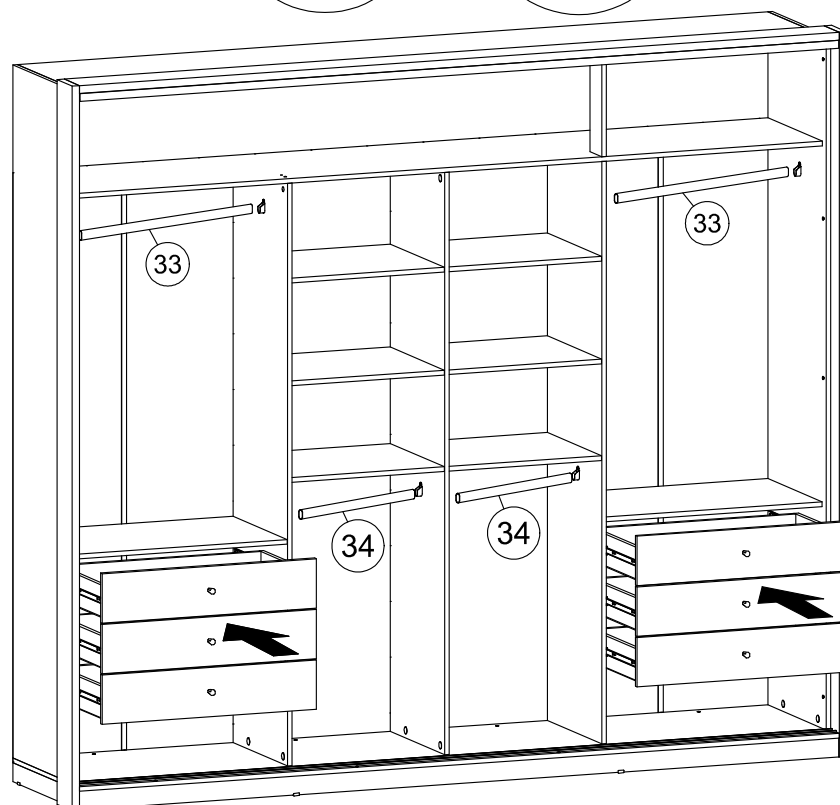
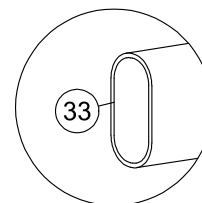
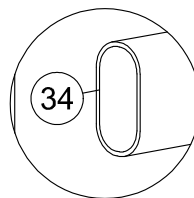



PASSO 25

PEÇAS NECESSÁRIAS

INDICE	QUANT.
26	4
27	2

FERRAGEM NECESSÁRIA

QTDE	IMAGEM	INDICE
16		P
32		T

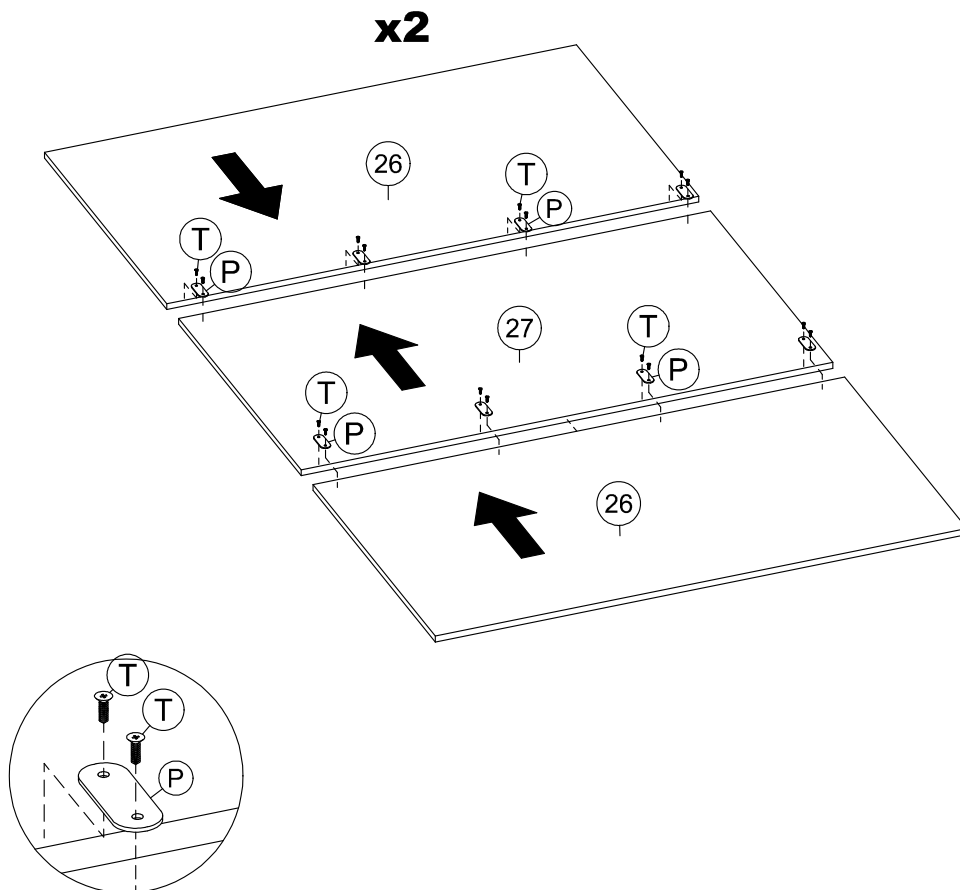

PASSO 26

PEÇAS NECESSÁRIAS

INDICE	QUANT.
31	2
32	2

FERRAGEM NECESSÁRIA

QTDE	IMAGEM	INDICE
36		T

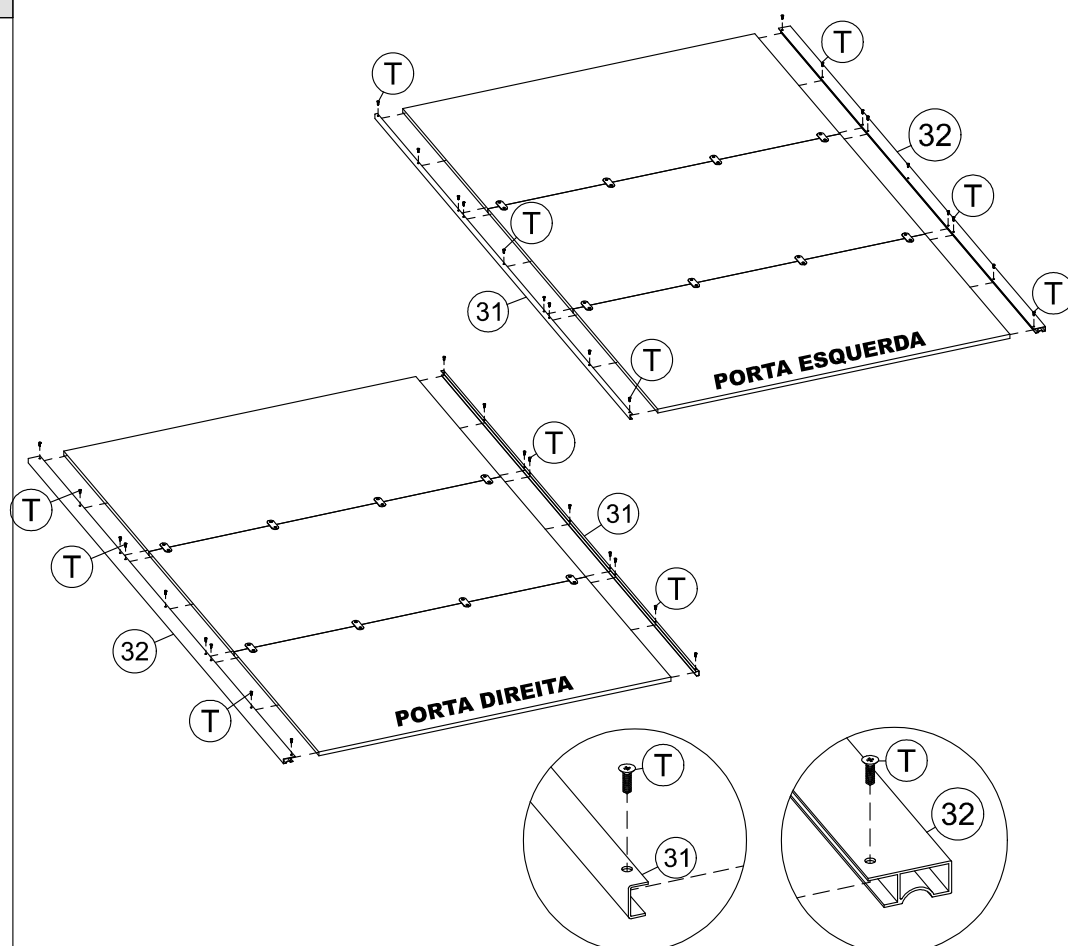

PASSO 27

PEÇAS NECESSÁRIAS

INDICE	QUANT.
28	2
40	2

FERRAGEM NECESSÁRIA

DESEMPENADOR PARA PORTA

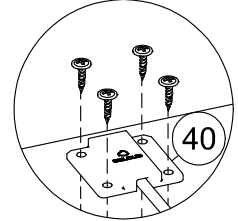

PARA FAZER A MONTAGEM USAR O MANUAL QUE ACOMPANHA O ITEM.

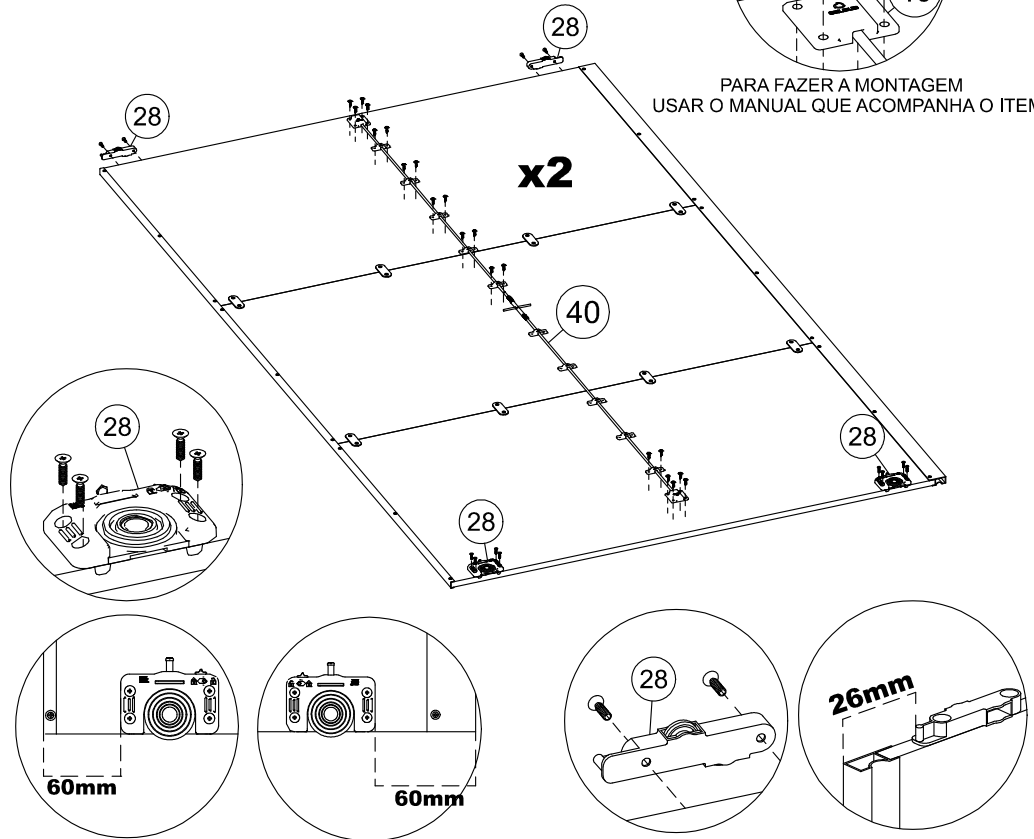

PASSO 28

PEÇAS NECESSÁRIAS

Colagem dos Espelhos:
Recomendamos a limpeza da peça com pano e álcool antes da colagem dos Espelhos.

Colar os Espelhos conforme medidas citadas abaixo.

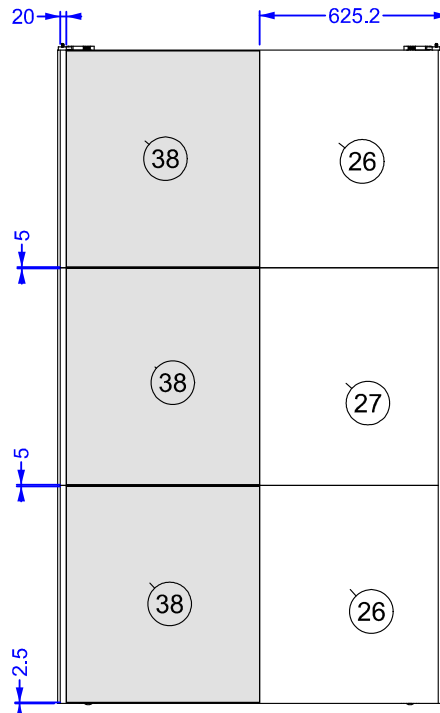

FERRAGEM NECESSÁRIA

PASSO 29

PEÇAS NECESSÁRIAS

INDICE	QUANT.
28	2

FERRAGEM NECESSÁRIA

Travas do Sistema de Correr

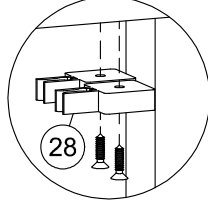

***Montar a Porta com Espelhos na parte da frente dos trilhos.**

